



US00D934315S

(12) **United States Design Patent** (10) **Patent No.:** **US D934,315 S**
Lavitsky et al. (45) **Date of Patent:** **** Oct. 26, 2021**

(54) **DEPOSITION RING FOR A SUBSTRATE PROCESSING CHAMBER**

(71) Applicant: **APPLIED MATERIALS, INC.**, Santa Clara, CA (US)

(72) Inventors: **Ilya Lavitsky**, San Francisco, CA (US); **Keith A Miller**, Mountain View, CA (US); **Goichi Yoshidome**, Albany, CA (US)

(73) Assignee: **APPLIED MATERIALS, INC.**, Santa Clara, CA (US)

(**) Term: **15 Years**

(21) Appl. No.: **29/728,822**

(22) Filed: **Mar. 20, 2020**

(51) **LOC (13) Cl.** **15-09**

(52) **U.S. Cl.**
USPC **D15/138**; D13/182

(58) **Field of Classification Search**
USPC D23/249, 259, 262, 269; D15/138, 139, D15/143, 144, 144.1, 144.2, 150, 199;
(Continued)

(56) **References Cited**

U.S. PATENT DOCUMENTS

4,949,884 A * 8/1990 Dahl B44D 3/127
220/792
D401,252 S * 11/1998 Tudhope D15/138
(Continued)

FOREIGN PATENT DOCUMENTS

JP 1252261 10/2005
JP 1267922 4/2006

(Continued)

OTHER PUBLICATIONS

International Search Report for PCT/US2021/022445, dated Jun. 30, 2021.

Primary Examiner — Brandon M Rosati

Assistant Examiner — Mark T. Philipps

(74) *Attorney, Agent, or Firm* — Moser Taboada

(57) **CLAIM**

The ornamental design for a deposition ring for a substrate processing chamber, as shown and described.

DESCRIPTION

FIG. 1 is an enlarged top isometric view of a deposition ring for a substrate processing chamber, according to the first embodiment of the novel design.

FIG. 2 is a top plan view thereof.

FIG. 3 is a bottom plan view thereof.

FIG. 4 is a left elevation view thereof.

FIG. 5 is a right elevation view thereof.

FIG. 6 is a front elevation view thereof.

FIG. 7 is a rear elevation view thereof.

FIG. 8 is a cross-sectional view taken along line 8-8 of FIG. 2.

FIG. 9 is an enlarged top isometric view of a deposition ring for a substrate processing chamber, according to the second embodiment of the novel design.

FIG. 10 is a top plan view thereof.

FIG. 11 is a bottom plan view thereof.

FIG. 12 is a left elevation view thereof.

FIG. 13 is a right elevation view thereof.

FIG. 14 is a front elevation view thereof.

FIG. 15 is a rear elevation view thereof; and,

FIG. 16 is a cross-sectional view taken along line 16-16 of FIG. 10.

The dashed lines in FIGS. 1-8 represent unclaimed environment forming no part of the claimed design.

1 Claim, 10 Drawing Sheets

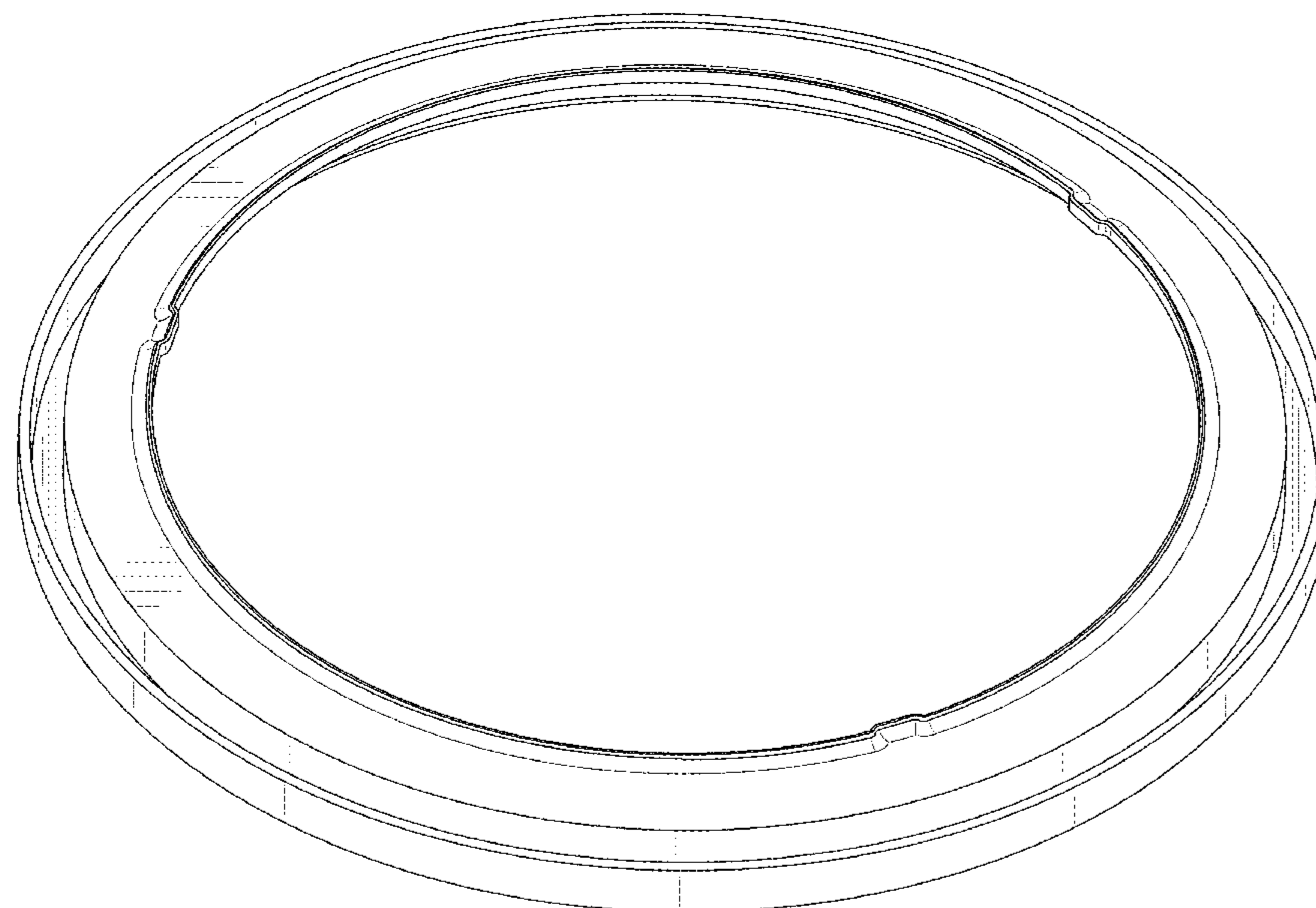

US D934,315 S

Page 2

(58) **Field of Classification Search**

USPC D13/118, 122, 133, 162, 182, 184, 199;
D22/113, 119
CPC H01J 37/3414; H01J 37/3423; H01L
21/02631; H01L 2221/68363; H01L
2224/75186-75189; H01L 21/67742;
H01L 21/0226; H01L 21/02263; H01L
21/02266; H01L 21/02269; H01L
21/02271; F16J 7/00; E04D 13/14; C23C
14/3407; C23C 14/35

See application file for complete search history.

(56) **References Cited**

U.S. PATENT DOCUMENTS

D403,002 S * 12/1998 Tudhope D15/138
D403,334 S * 12/1998 Tudhope D15/138
D403,337 S * 12/1998 Or D15/199
D491,963 S * 6/2004 Doha D15/144
D557,226 S * 12/2007 Uchino D13/182
D559,994 S * 1/2008 Nagakubo D24/232
D649,986 S * 12/2011 Fujikata D15/138
D659,175 S * 5/2012 Fujikata D15/138
D665,491 S * 8/2012 Goel D23/386
D694,790 S * 12/2013 Matsumoto D15/144
D709,538 S * 7/2014 Mizukami D15/138
D738,451 S * 9/2015 Olson D21/790
D767,234 S * 9/2016 Kirkland D34/29
D770,992 S * 11/2016 Tauchi D13/182
D797,067 S * 9/2017 Zhang D13/182
D797,691 S * 9/2017 Joubert D13/182
D810,705 S * 2/2018 Krishnan D13/182
D819,580 S * 6/2018 Krishnan D13/182
10,347,475 B2 7/2019 Scheible et al.
D876,504 S * 2/2020 Lee D15/138

D888,903 S * 6/2020 Gunther D23/269
D891,382 S * 7/2020 Koppa D13/182
2004/0074933 A1* 4/2004 Tilbrook B65D 47/063
222/530
2008/0178801 A1 7/2008 Pavloff et al.
2008/0308416 A1* 12/2008 Allen C23C 14/3407
204/298.12
2010/0108500 A1* 5/2010 Hawrylchak C23C 14/3407
204/298.13
2011/0209985 A1* 9/2011 Li C23C 14/541
204/192.12
2012/0263569 A1* 10/2012 Priddy C30B 23/02
414/800
2015/0357169 A1* 12/2015 Yuan B23K 35/24
204/298.13
2016/0002788 A1* 1/2016 Nal C23C 16/45521
118/724
2016/0189938 A1 6/2016 Savandaiah et al.
2017/0002461 A1 1/2017 Johanson et al.
2017/0009367 A1* 1/2017 Harris C25D 17/06
2017/0076924 A1 3/2017 Johanson et al.
2018/0087147 A1 3/2018 Rasheed et al.
2018/0142340 A1 5/2018 Johanson et al.
2019/0096638 A1 3/2019 Lavitsky et al.
2020/0090915 A1* 3/2020 Kerschbaumer C23C 14/3407

FOREIGN PATENT DOCUMENTS

JP 1435220 3/2012
JP 1646366 11/2019
KR 30-0725455 1/2014
KR 30-0725456 1/2014
KR 30-1024426 12/2018
KR 30-1064100 9/2019
TW D197825 6/2019
TW D197827 6/2019

* cited by examiner

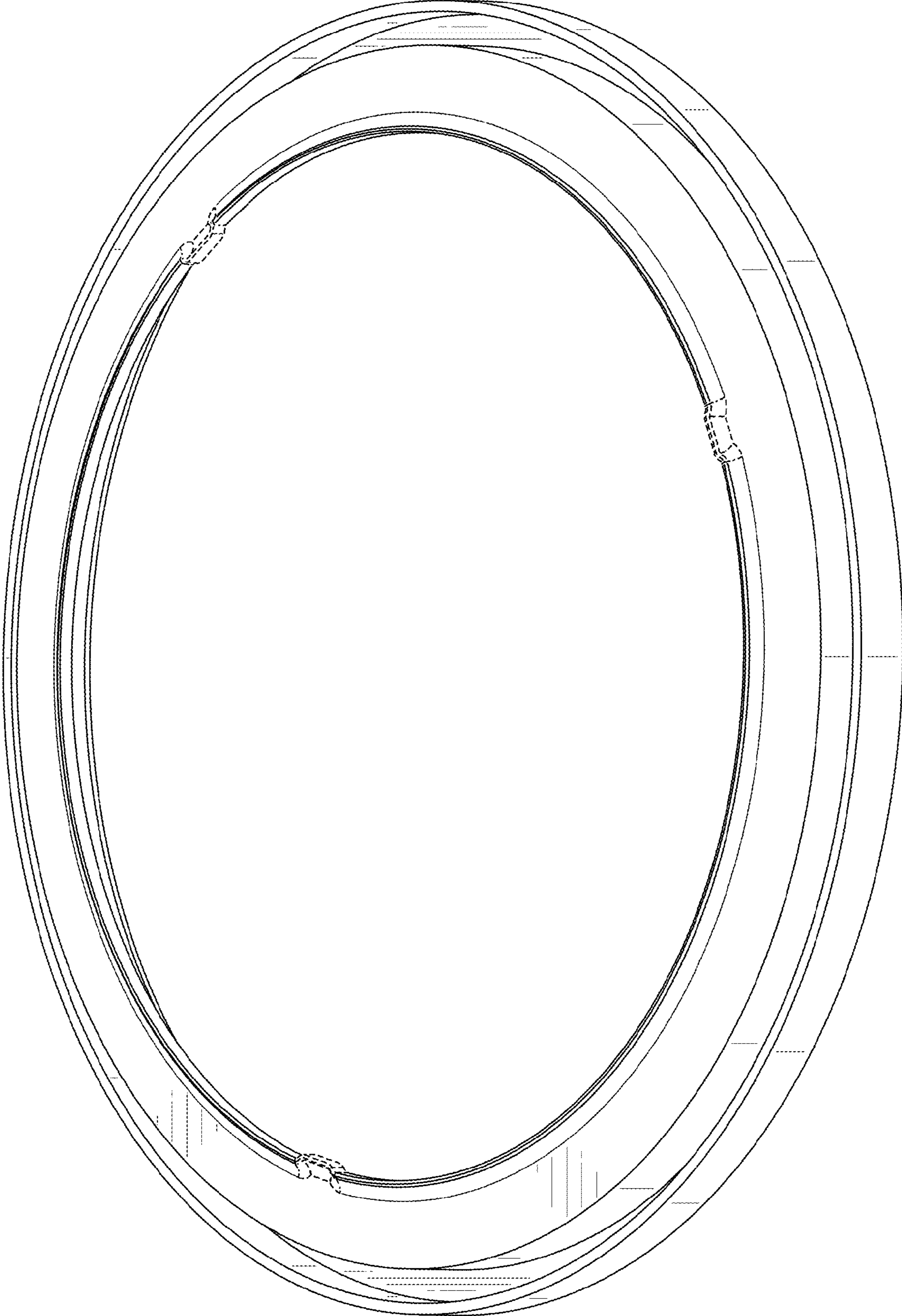

FIG. 1

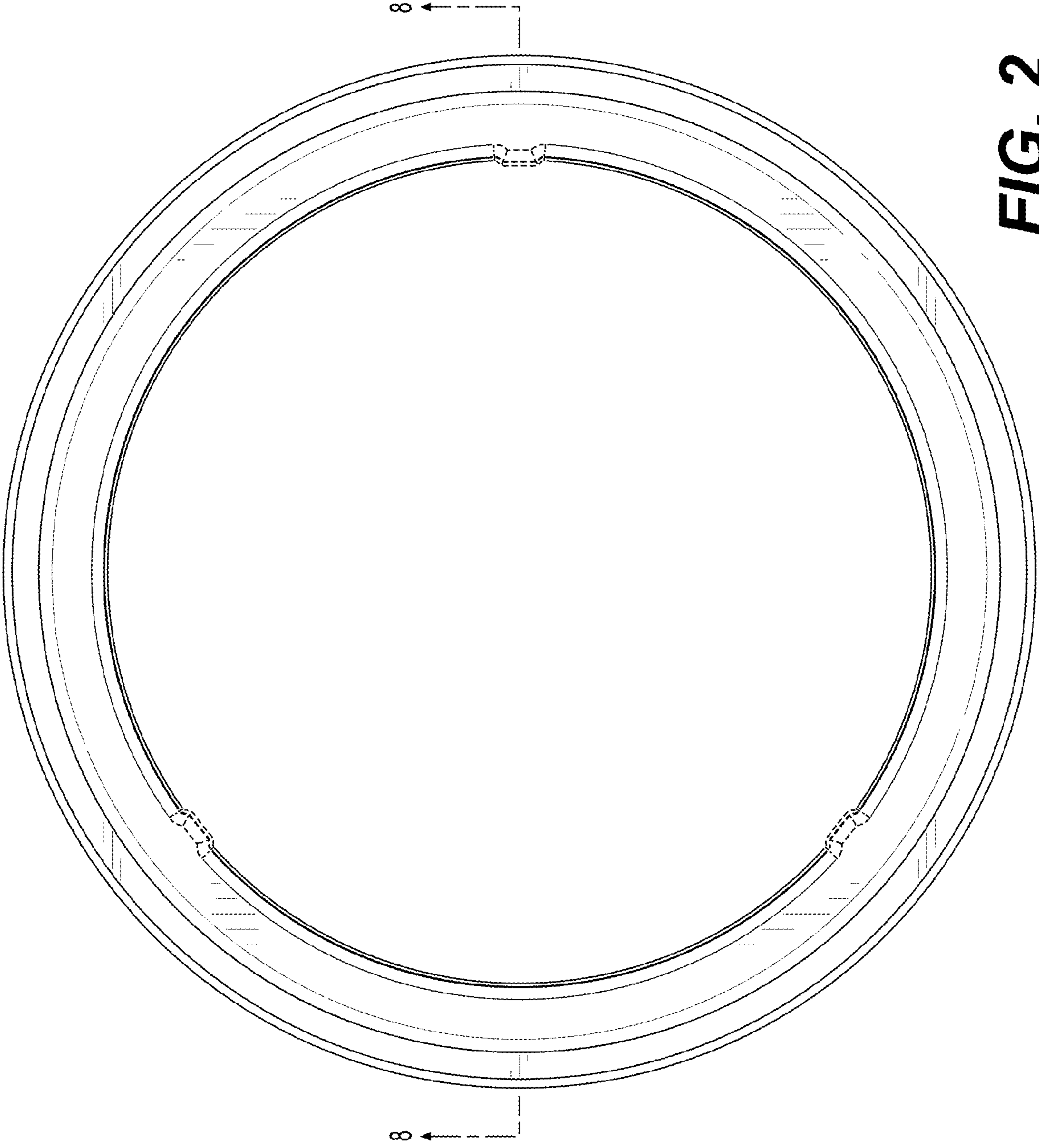

FIG. 2

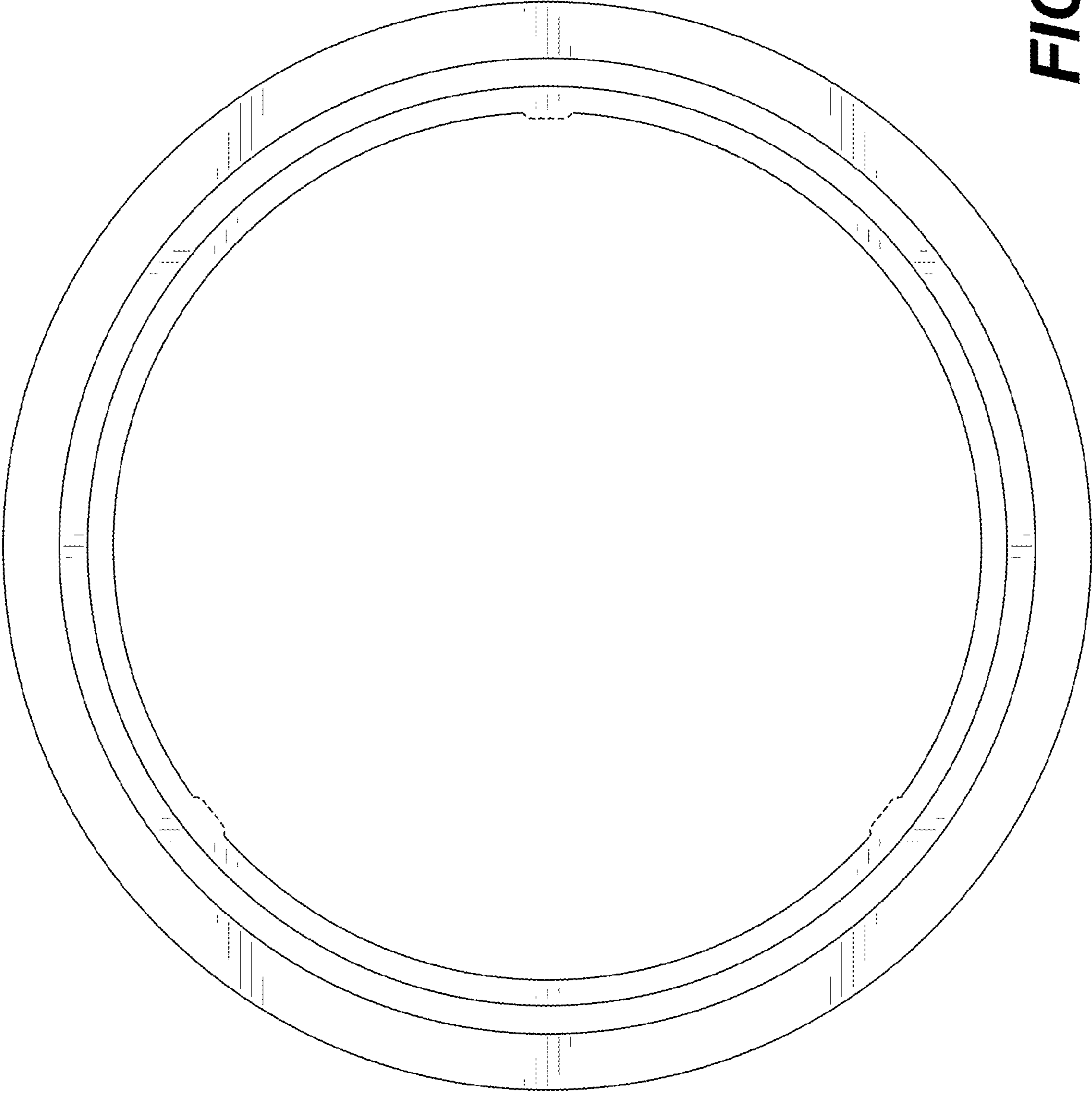

FIG. 3

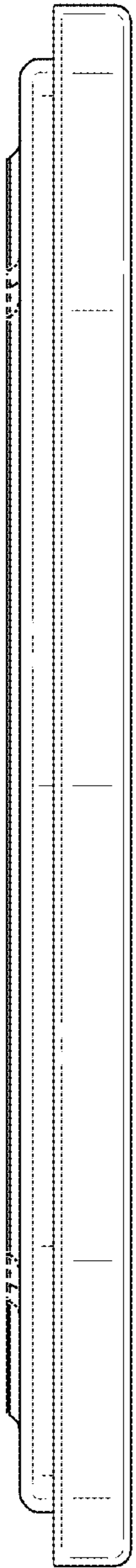

FIG. 4

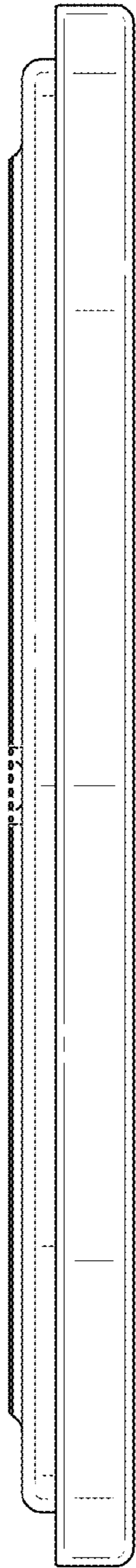

FIG. 5

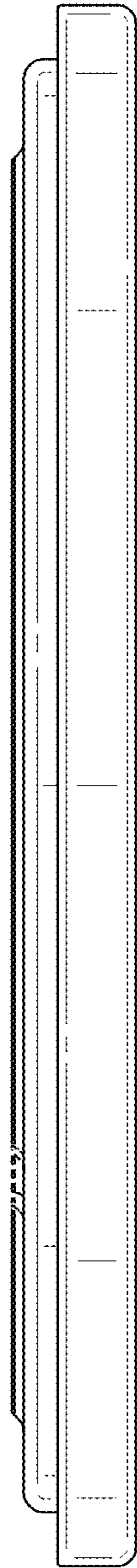

FIG. 6

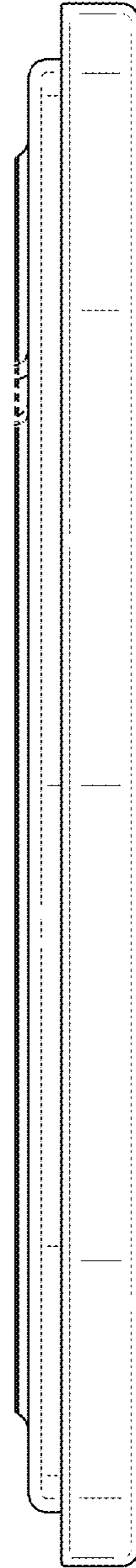

FIG. 7

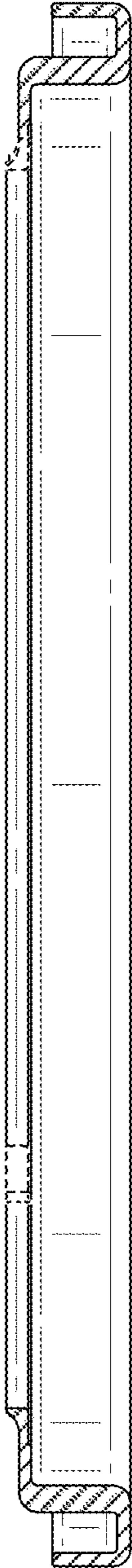

FIG. 8

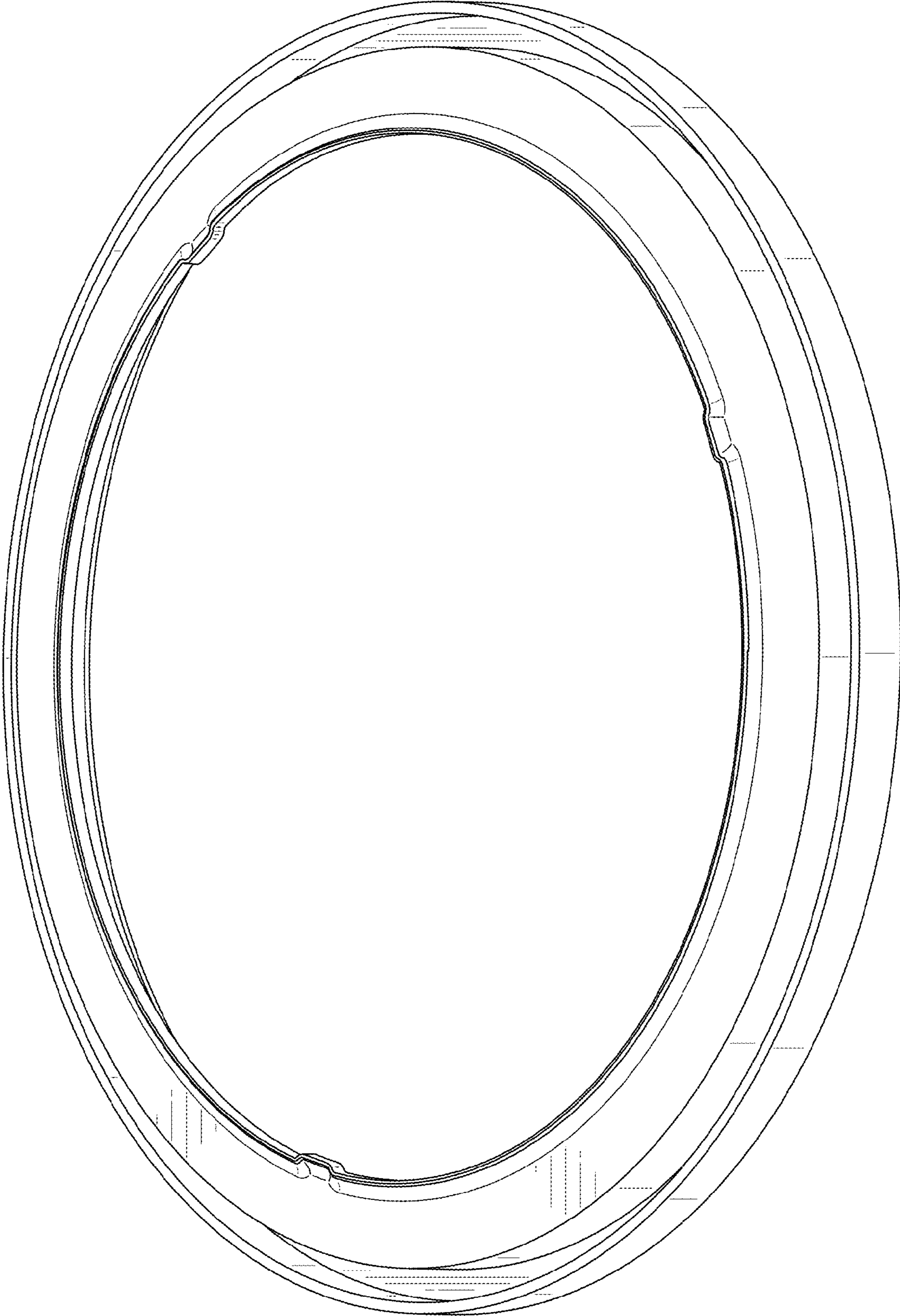

FIG. 9

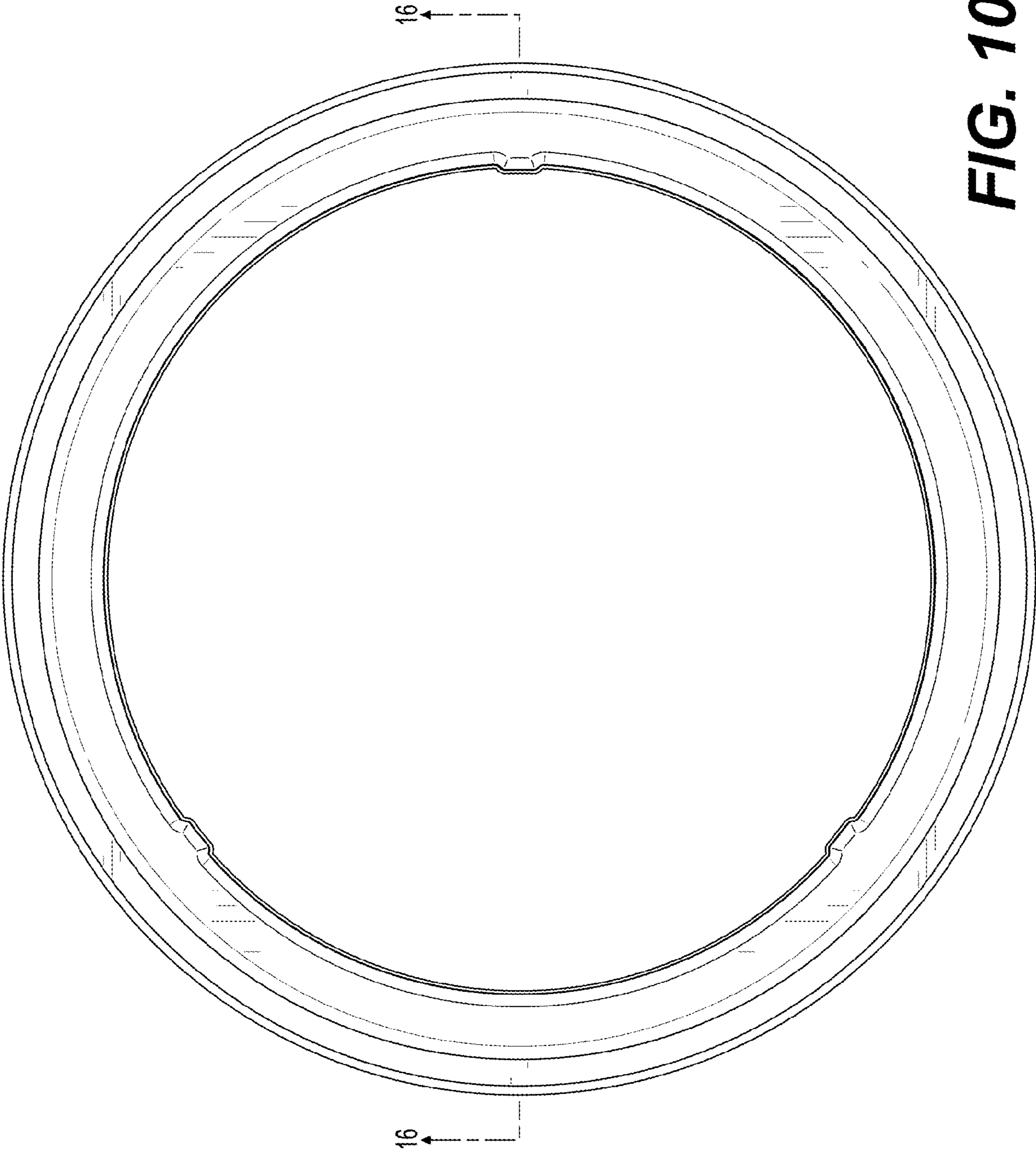

FIG. 10

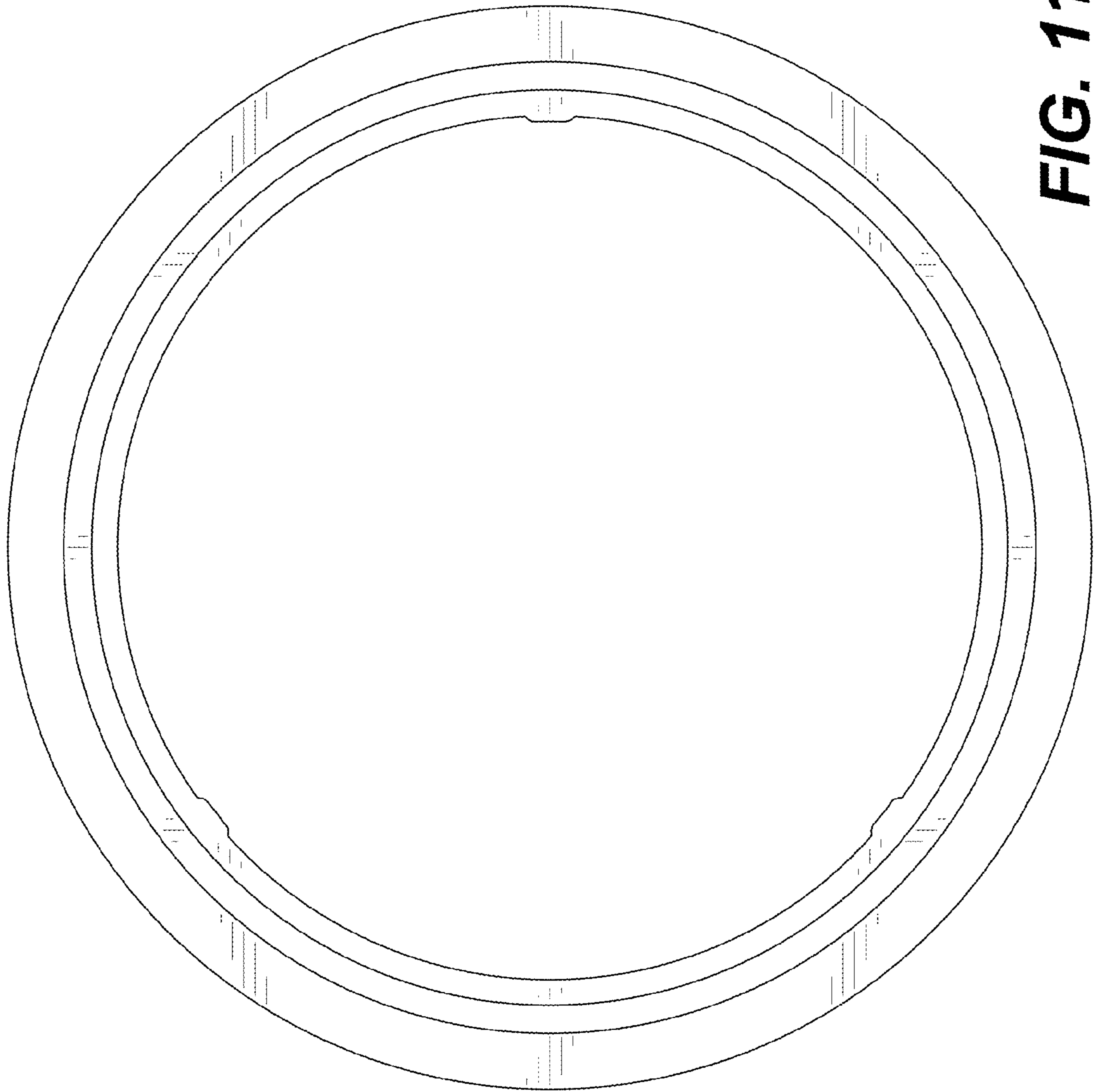

FIG. 11

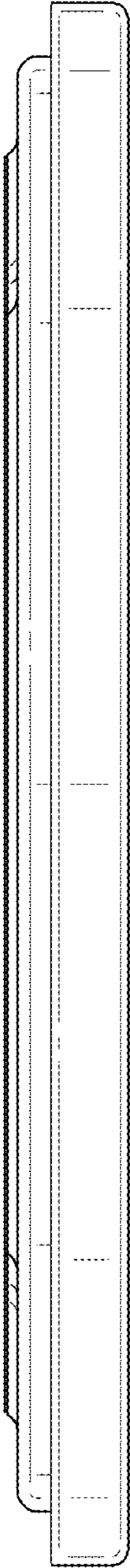

FIG. 12

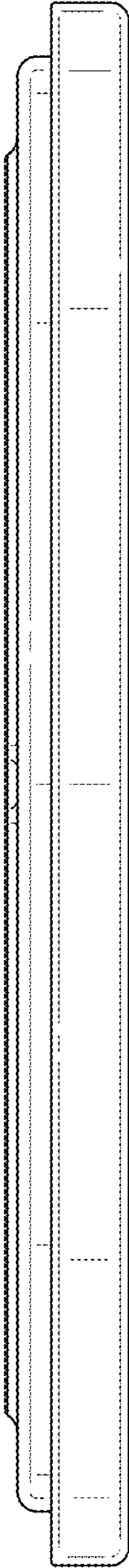

FIG. 13

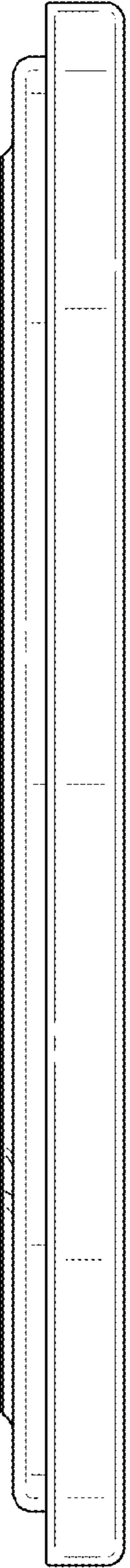

FIG. 14

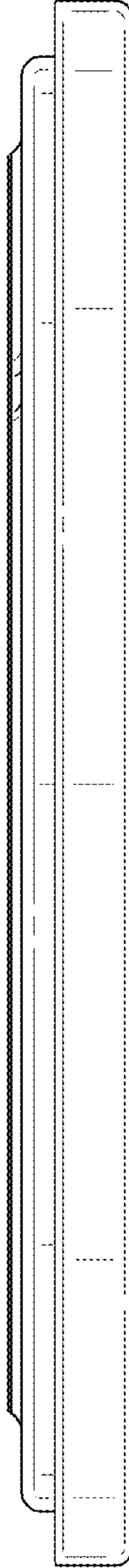

FIG. 15

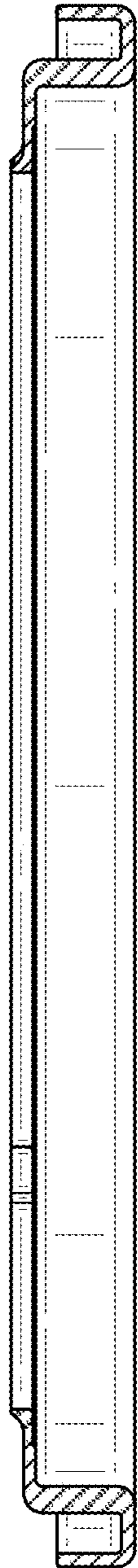

FIG. 16