



US00D934183S

(12) **United States Design Patent**
Joyce

(10) **Patent No.:** **US D934,183 S**

(45) **Date of Patent:** **** Oct. 26, 2021**

(54) **CABLE JACKET**

(71) Applicant: **Craig M. Joyce**, Auburn, NH (US)

(72) Inventor: **Craig M. Joyce**, Auburn, NH (US)

(**) Term: **15 Years**

(21) Appl. No.: **29/770,179**

(22) Filed: **Feb. 10, 2021**

Related U.S. Application Data

(63) Continuation-in-part of application No. 29/663,944, filed on Sep. 20, 2018, now abandoned.

(51) **LOC (13) Cl.** **13-03**

(52) **U.S. Cl.**

USPC **D13/153**

(58) **Field of Classification Search**

USPC D13/107, 108, 110, 123, 133,
D13/137.1–137.4, 138.1–138.2,
D13/139.1–139.8, 152, 184, 147, 199,
D13/146, 151, 153, 164, 177, 154–156;
D8/350, 353–356, 394–396, 349;
D25/121–125, 108

CPC H01R 11/00; H01R 9/00; H01R 13/00;
H01R 13/04; H01R 13/10; H01R
13/6666; H01R 13/6675; H01R 13/46;
H01R 25/00; H01R 25/006; H01R 24/28;
H01R 13/6392; H01H 2207/00; H01H
2207/022; H01B 7/2806; H01B 5/06;
H01B 7/16–18; H01B 3/082; H01B
7/0823; F16B 15/00; F16L 3/12; F15L
7/00

See application file for complete search history.

(56) **References Cited**

U.S. PATENT DOCUMENTS

1,002,691 A † 9/1911 Higby F16M 13/02
248/20
2,043,044 A † 6/1936 Knoderer H01B 7/202
174/10

2,105,060 A * 1/1938 Strom H01B 3/082
174/111
2,606,953 A † 8/1952 Weston H01B 11/1808
174/12
2,628,998 A † 2/1953 Frisbie H01B 7/0823
174/11
2,950,338 A † 8/1960 Taylor H01B 7/221
174/40
3,041,719 A * 7/1962 Haseltine B21C 37/151
29/517

(Continued)

OTHER PUBLICATIONS

Office Action for U.S. Appl. No. 29/663,944, dated Nov. 12, 2020, 21 Pages.

Primary Examiner — Christy Nemeth

(74) *Attorney, Agent, or Firm* — Maine Cernota & Rardin

(57) **CLAIM**

The ornamental design for a cable jacket, as shown and described.

DESCRIPTION

FIG. 1 is a top perspective view of a cable jacket of my new design;
FIG. 2 is a bottom perspective view thereof;
FIG. 3 is a front elevation view thereof;
FIG. 4 is a rear elevation view thereof;
FIG. 5 is a left-side elevation view thereof;
FIG. 6 is a right-side elevation view thereof;
FIG. 7 is a top plan view thereof; and,
FIG. 8 is a bottom plan view thereof.

The broken lines in the drawings are for the purpose of illustrating environmental subject matter that forms no part of the claim. The cable jacket is shown with a symbolic break in its length. The appearance of any portion of the article between the break lines forms no part of the claimed design.

1 Claim, 8 Drawing Sheets

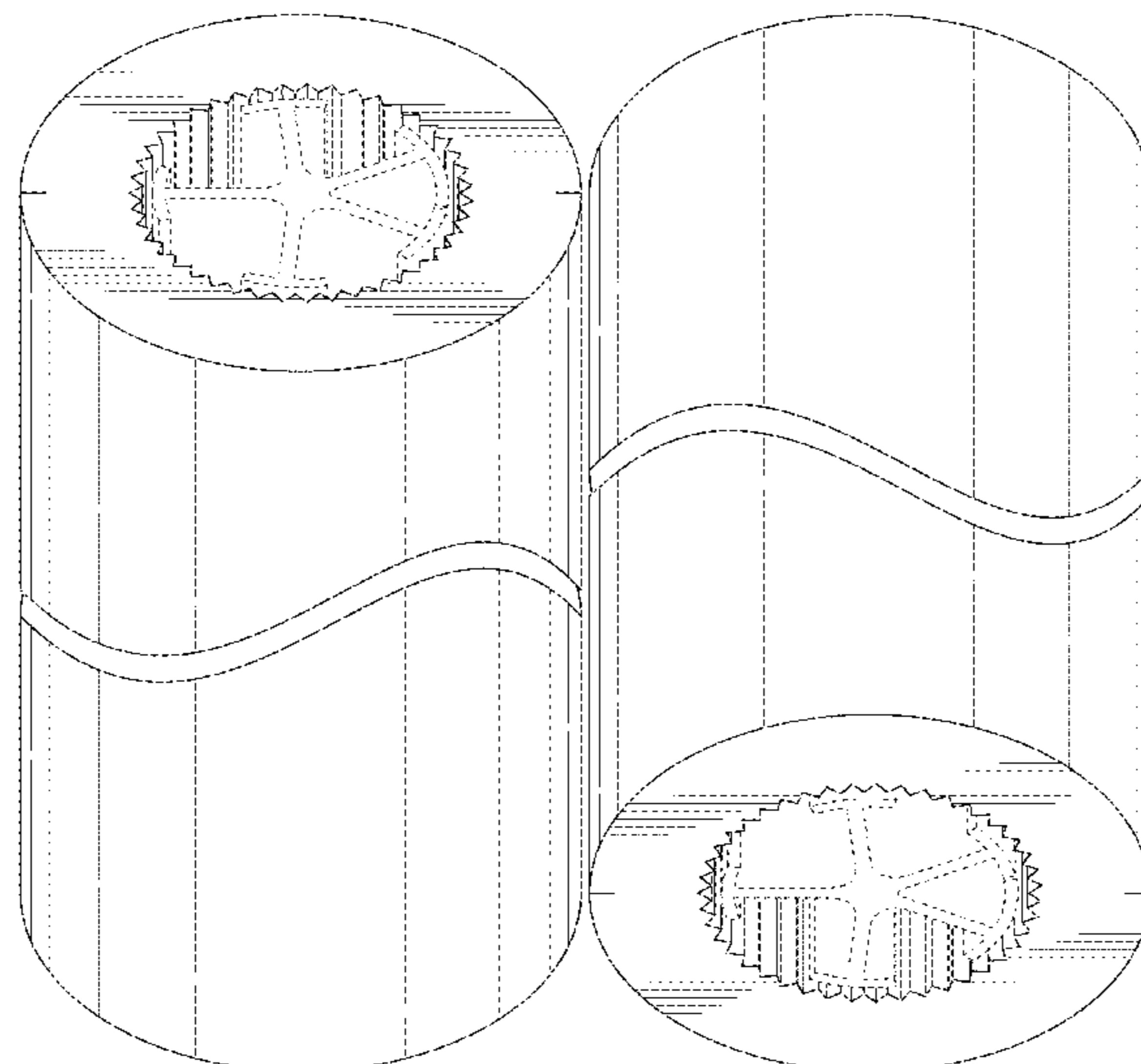

(56)

References Cited

U.S. PATENT DOCUMENTS

3,173,987 A ‡ 3/1965 Potruch H02G 15/076
174/54
3,800,065 A ‡ 3/1974 Bunish H01B 7/0823
174/11
3,871,731 A * 3/1975 LaCoursiere, Sr.
H01R 13/6395
439/369
3,930,419 A ‡ 1/1976 Kramer F16C 1/26
74/502
4,218,581 A ‡ 8/1980 Suzuki H01B 7/0823
174/11
D262,617 S ‡ 1/1982 Shumate D13/15
4,580,767 A * 4/1986 Zimmerman H01B 17/145
174/158 F
4,799,641 A ‡ 1/1989 Koreski F16L 3/2235
24/329
D301,722 S * 6/1989 Sachs D20/22
5,057,646 A ‡ 10/1991 Nichols H01B 9/003
174/36
D330,774 S * 11/1992 Klaric D25/125
5,273,454 A * 12/1993 Shotey H01R 13/6392
174/138 F
5,342,991 A ‡ 8/1994 Xu H01B 7/0823
174/11
5,389,082 A ‡ 2/1995 Baugues A61M 5/1418
5,486,654 A ‡ 1/1996 Hanak H01B 7/0807
174/11
D375,159 S * 10/1996 Johansson D23/266
D375,890 S ‡ 11/1996 Takai D8/380
D376,786 S * 12/1996 Binzel, Jr. D13/153
D408,365 S * 4/1999 Sanders D13/153
D408,560 S * 4/1999 Bruder D25/122
D440,005 S ‡ 4/2001 Blanton 24/16 R
D461,448 S * 8/2002 Amin D13/133
D473,663 S * 4/2003 Chou D25/122
D474,447 S ‡ 5/2003 Kano D13/13
6,563,990 B1 ‡ 5/2003 Hurley G02B 6/4422
385/10
D483,862 S * 12/2003 Rawlings D24/119
6,734,364 B2 ‡ 5/2004 Price H01B 7/0853
174/11
D551,880 S * 10/2007 Chen D25/122
D580,360 S * 11/2008 Vitito D13/146

D603,693 S * 11/2009 Bentrim D8/349
D610,900 S * 3/2010 Piermayr D8/394
D616,292 S * 5/2010 Martinson D8/394
8,068,711 B2 * 11/2011 Sielaff G02B 6/4471
385/134
D706,225 S ‡ 6/2014 deLoache, III D13/15
D707,106 S * 6/2014 Crounse D8/356
D707,107 S * 6/2014 Crounse D8/356
D712,358 S * 9/2014 Allen D13/147
D722,867 S ‡ 2/2015 Papafagos D8/396
9,163,615 B2 ‡ 10/2015 Williams F03G 7/065
D750,570 S ‡ 3/2016 Smith D13/15
D760,524 S * 7/2016 Bonuccelli D6/709
D763,061 S * 8/2016 Ezell D8/349
D767,488 S * 9/2016 Esses D13/107
9,545,743 B2 ‡ 1/2017 Joyce B29C 48/156
D778,841 S * 2/2017 Seever D13/155
D802,800 S * 11/2017 Mendini D25/124
10,002,691 B1 6/2018 Salz
D838,676 S * 1/2019 Smith D13/155
D847,091 S * 4/2019 Bureacov D13/133
D848,373 S ‡ 5/2019 Ramakrishna Gowda D13/14
D850,385 S * 6/2019 Gregori D13/147
D852,152 S * 6/2019 Lawrence D13/184
D852,354 S ‡ 6/2019 Wrangmark D24/12
D853,336 S ‡ 7/2019 Barram D13/15
D858,457 S ‡ 9/2019 Maggard D13/15
D863,944 S * 10/2019 Martinson D8/394
D863,945 S * 10/2019 Martinson D8/394
D863,946 S * 10/2019 Martinson D8/394
D870,659 S * 12/2019 Liao D13/108
D875,053 S * 2/2020 Shono D13/182
D880,430 S ‡ 4/2020 Sugie D13/15
D913,959 S * 3/2021 Joyce D13/155
D913,961 S * 3/2021 Campos D13/155
D913,962 S * 3/2021 Campos D13/155
D915,302 S * 4/2021 Campos D13/155
2007/0037435 A1 * 2/2007 Brus H02G 15/184
439/404
2015/0068357 A1 * 3/2015 Wen F16C 1/267
74/502.5
2016/0005511 A1 * 1/2016 Gravermann H02G 15/18
174/251
2020/0005970 A1 * 1/2020 Facinelli C08G 69/26

* cited by examiner

‡ imported from a related application

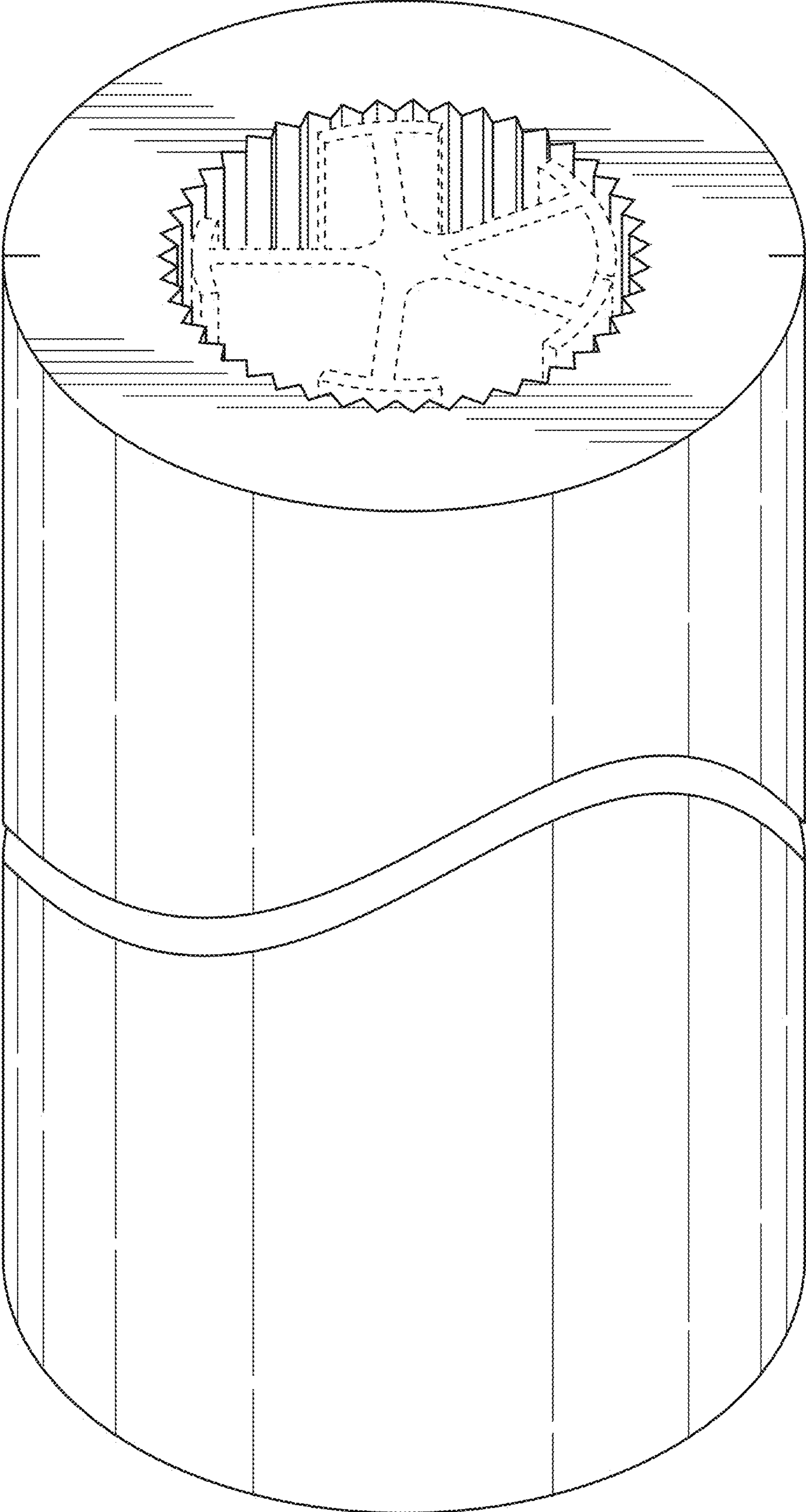

FIG. 1

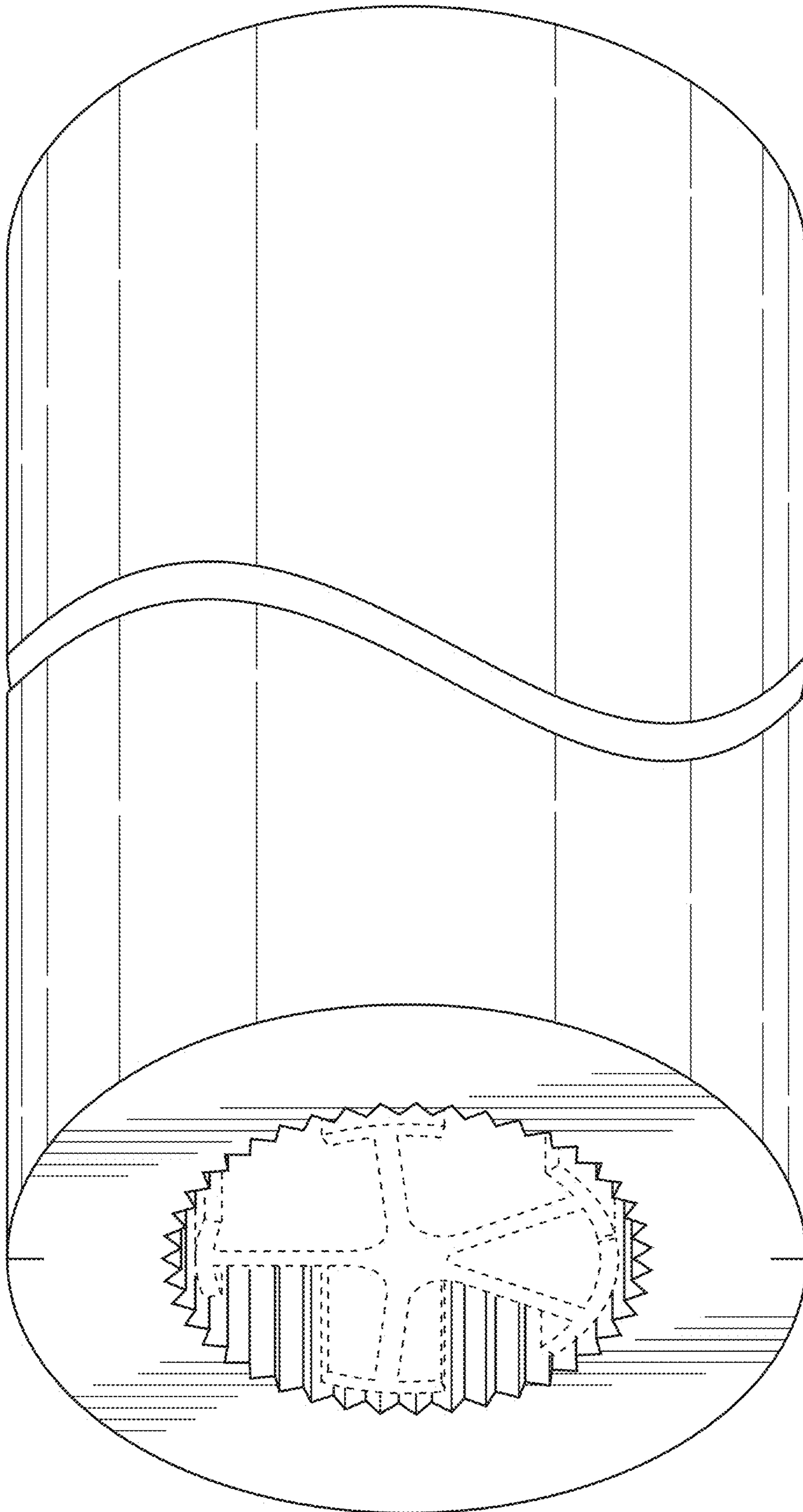

FIG. 2

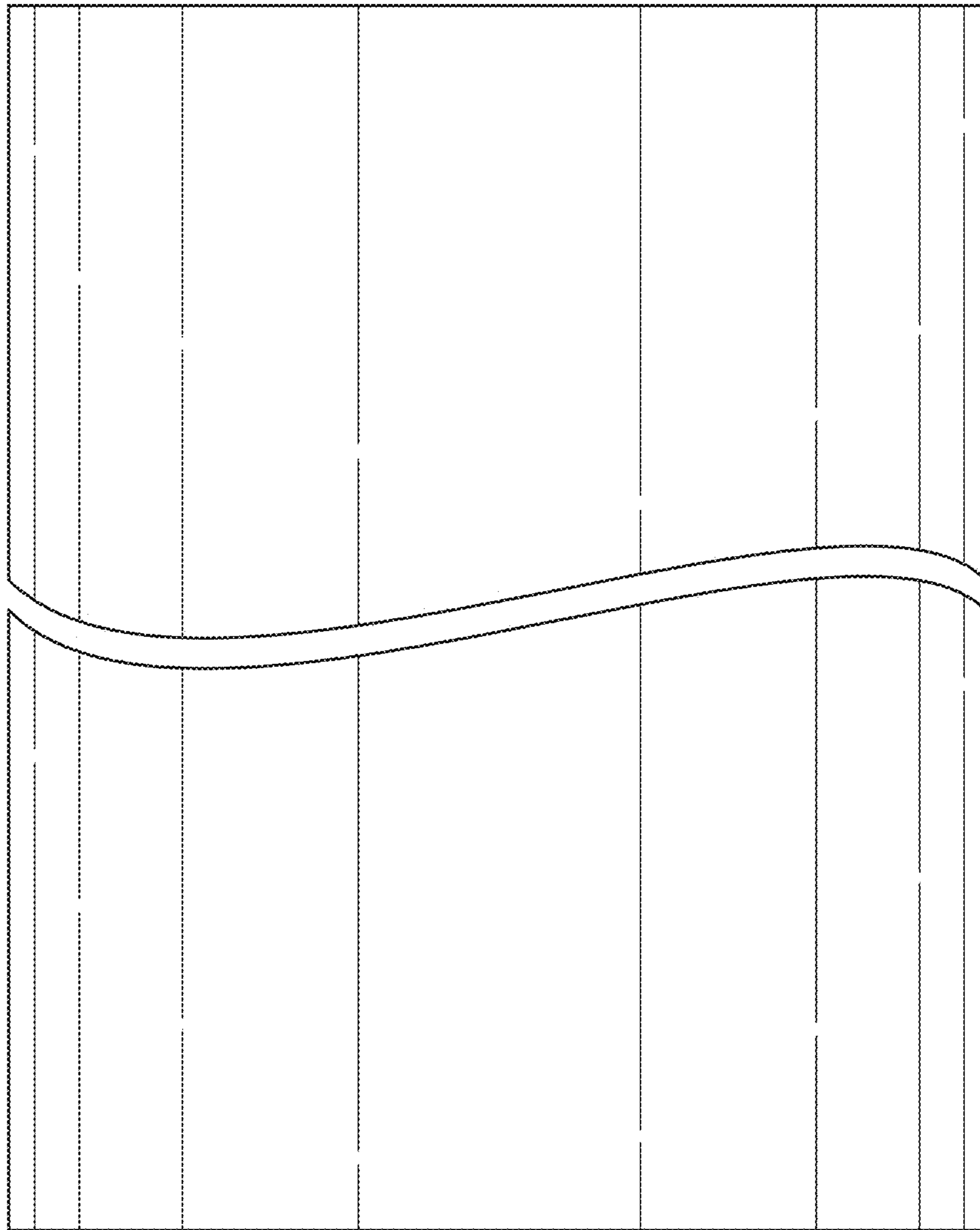

FIG. 3

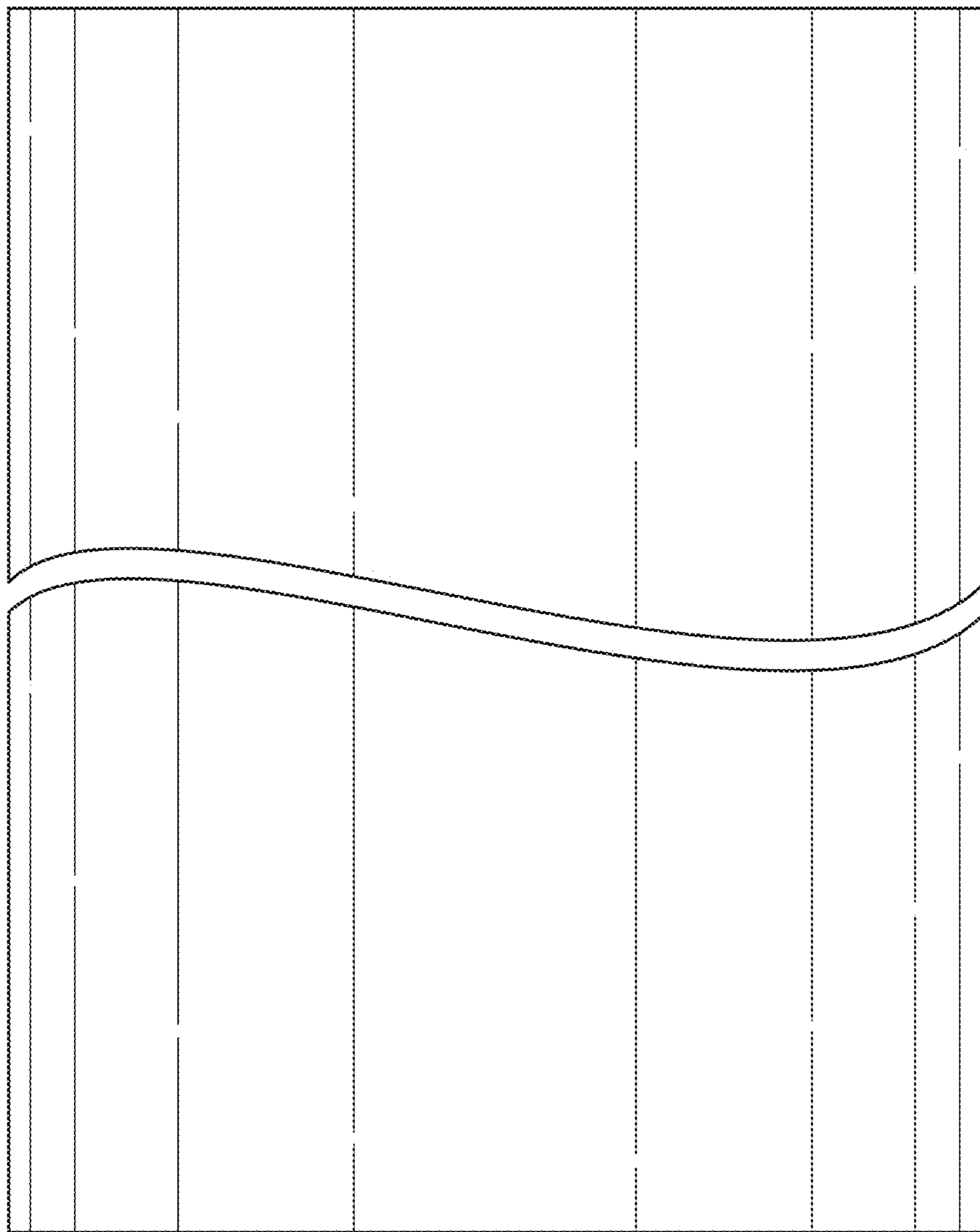

FIG. 4

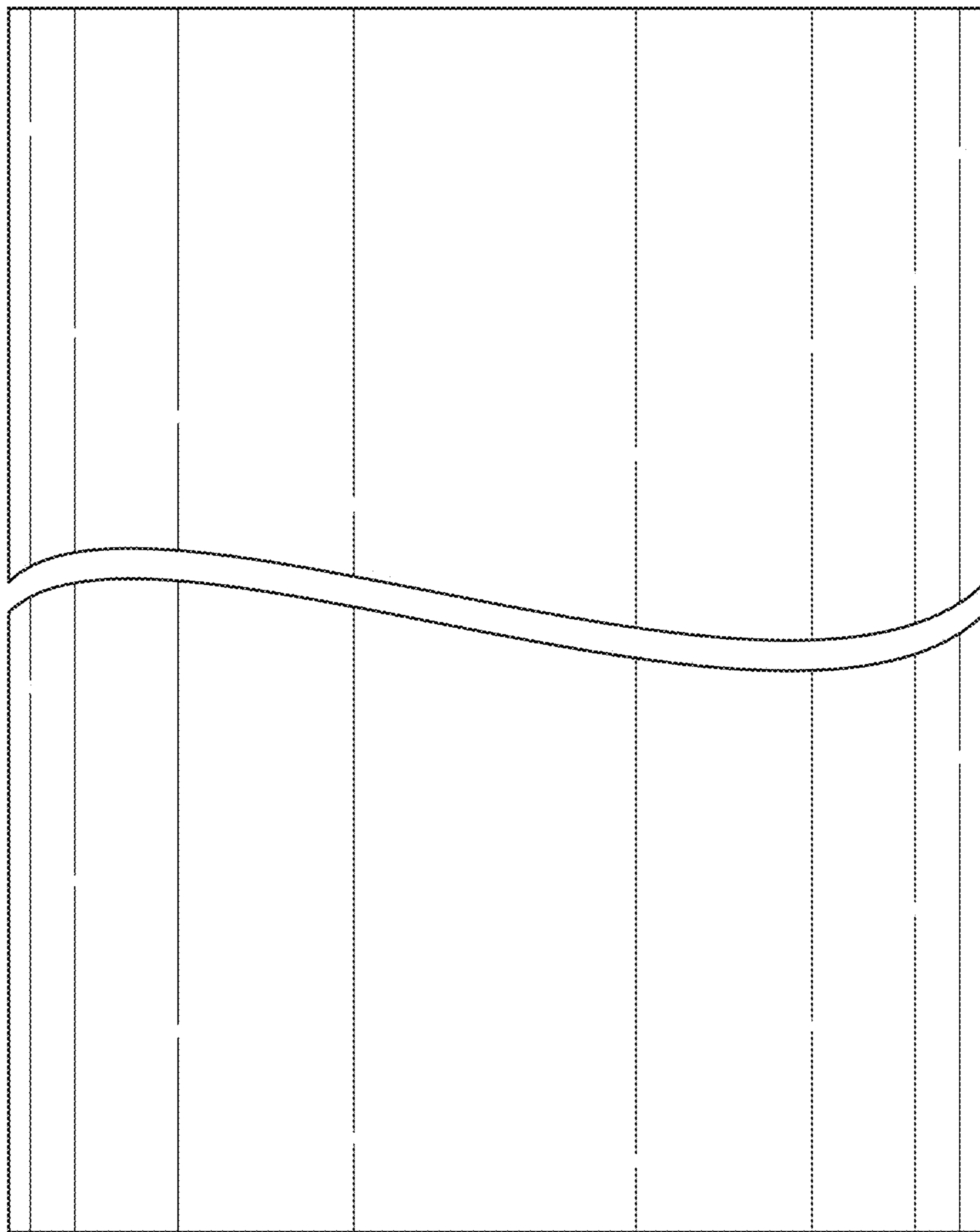

FIG. 5

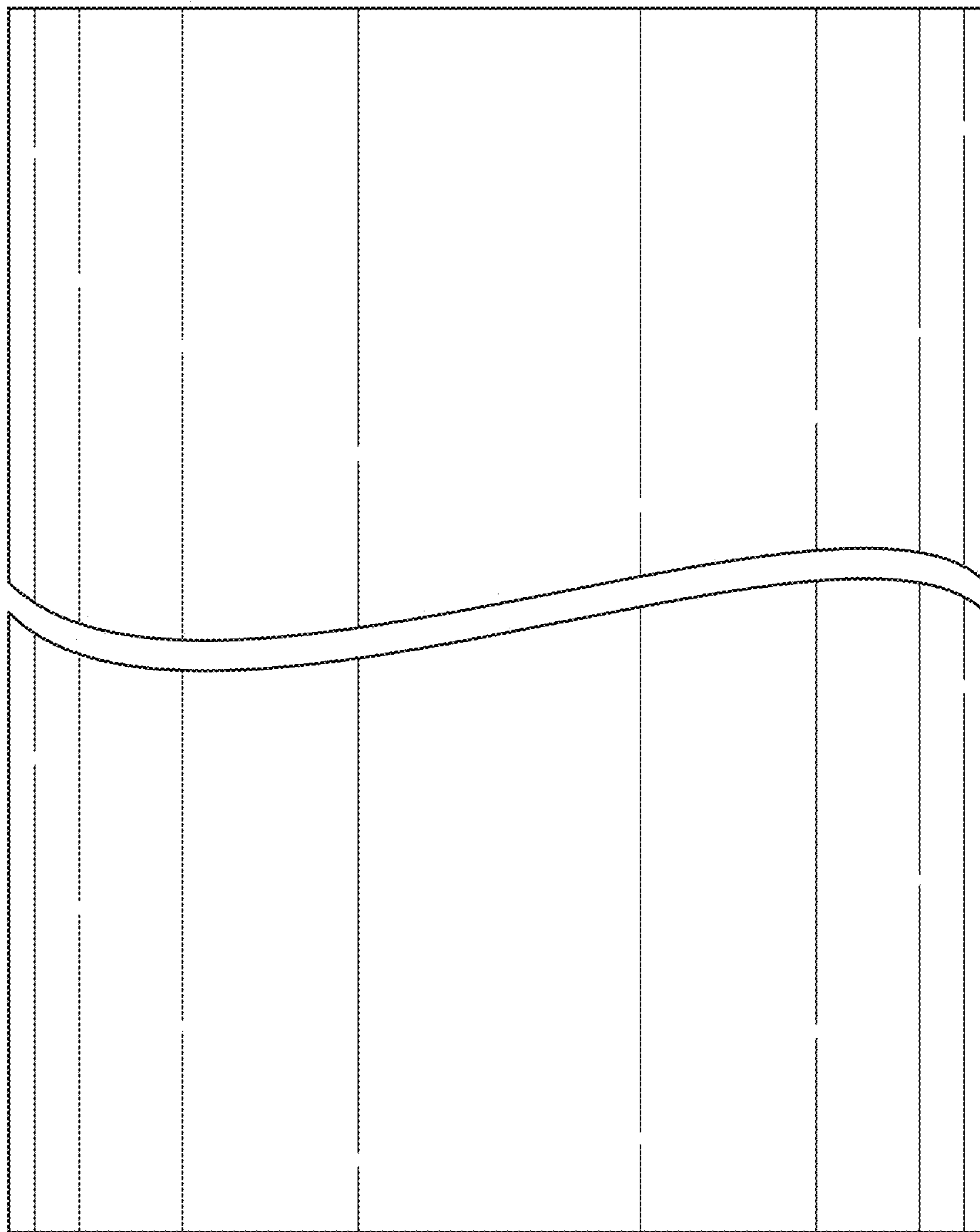

FIG. 6

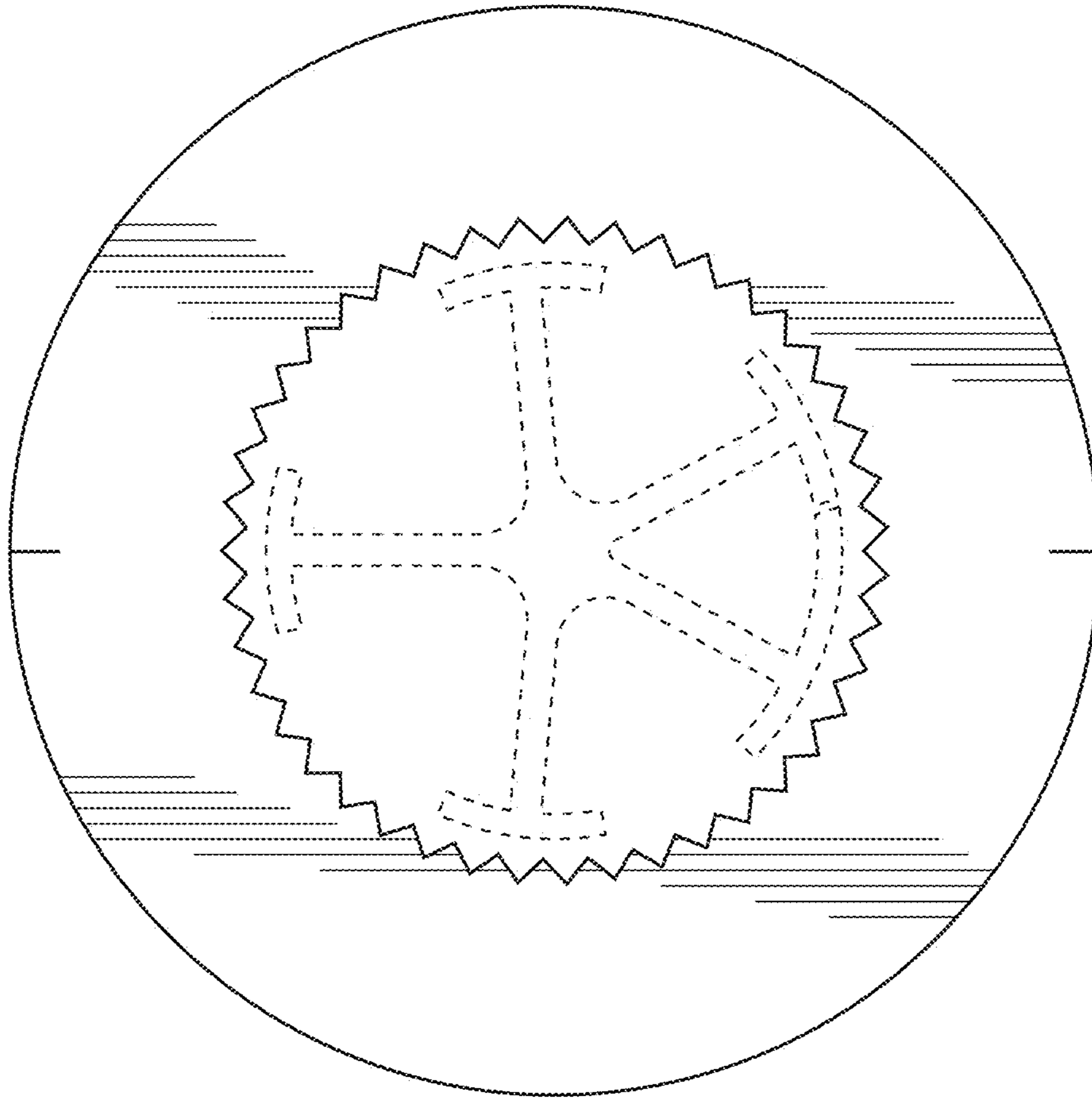

FIG. 7

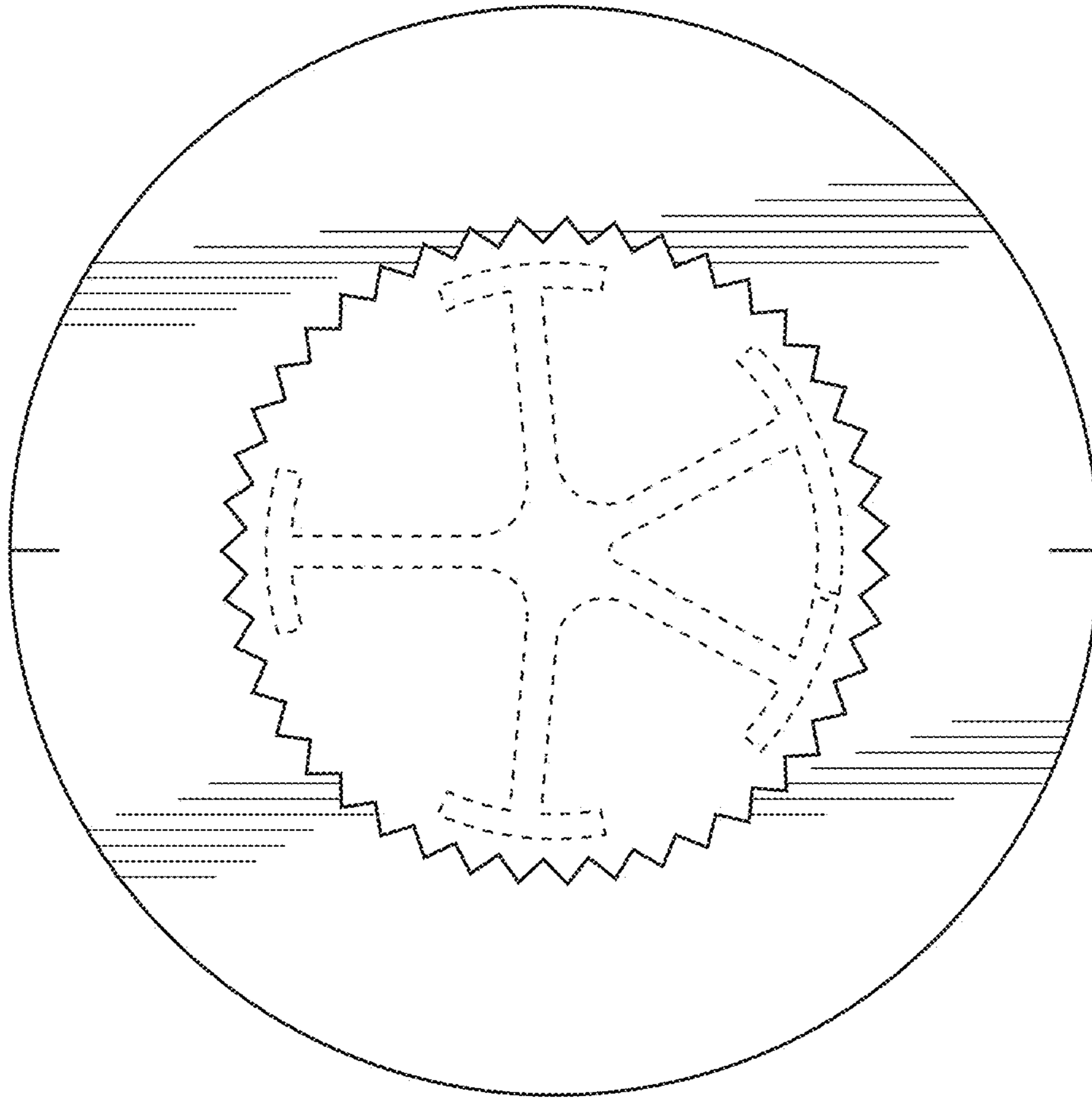

FIG. 8