

US00D934171S

(12) **United States Design Patent**
Yuan

(10) **Patent No.:** **US D934,171 S**

(45) **Date of Patent:** **** Oct. 26, 2021**

(54) **PLUG**

(71) Applicant: **Ruhe Yuan**, Jiujiang (CN)

(72) Inventor: **Ruhe Yuan**, Jiujiang (CN)

(**) Term: **15 Years**

(21) Appl. No.: **29/719,806**

(22) Filed: **Jan. 8, 2020**

(51) **LOC (13) Cl.** **13-02**

(52) **U.S. Cl.**
USPC **D13/110; D13/137.2**

(58) **Field of Classification Search**
USPC D13/110, 101, 107, 108, 118, 133,
D13/137.1-137.4, 138.1, 138.2, 139.1,
D13/146, 184, 199; D14/432, 433
CPC H01R 4/66; H01R 13/44; H01R 13/4534;
H01R 13/639; H01R 13/6633; H01R
13/453; H01R 27/00; H01R 27/02; H01R
29/00; H01R 31/06; H02M 1/10
See application file for complete search history.

(56) **References Cited**

U.S. PATENT DOCUMENTS

D480,358 S * 10/2003 Klant D13/110
D623,595 S * 9/2010 Ruffner D13/139.1

D664,094 S * 7/2012 Ruffner D13/138.2
D830,307 S * 10/2018 Liu D13/137.2
D838,245 S * 1/2019 Lin D13/137.2
D841,654 S * 2/2019 Lin D14/433
D863,223 S * 10/2019 Zeng D13/137.2
D864,863 S * 10/2019 Lee D13/110
10,686,285 B2 * 6/2020 Cai H01R 13/6485

* cited by examiner

Primary Examiner — Derrick E Holland

(57) **CLAIM**

The ornamental design for a plug, as shown and described.

DESCRIPTION

FIG. 1 is a first perspective view of a plug showing my new design;
FIG. 2 is a second perspective view thereof;
FIG. 3 is a front view thereof;
FIG. 4 is a back view thereof;
FIG. 5 is a left side view thereof;
FIG. 6 is a right side view thereof;
FIG. 7 is a top view thereof; and,
FIG. 8 is a bottom view thereof.
The broken lines shown in the drawings depict portions of the plug that form no part of the claimed design.

1 Claim, 8 Drawing Sheets

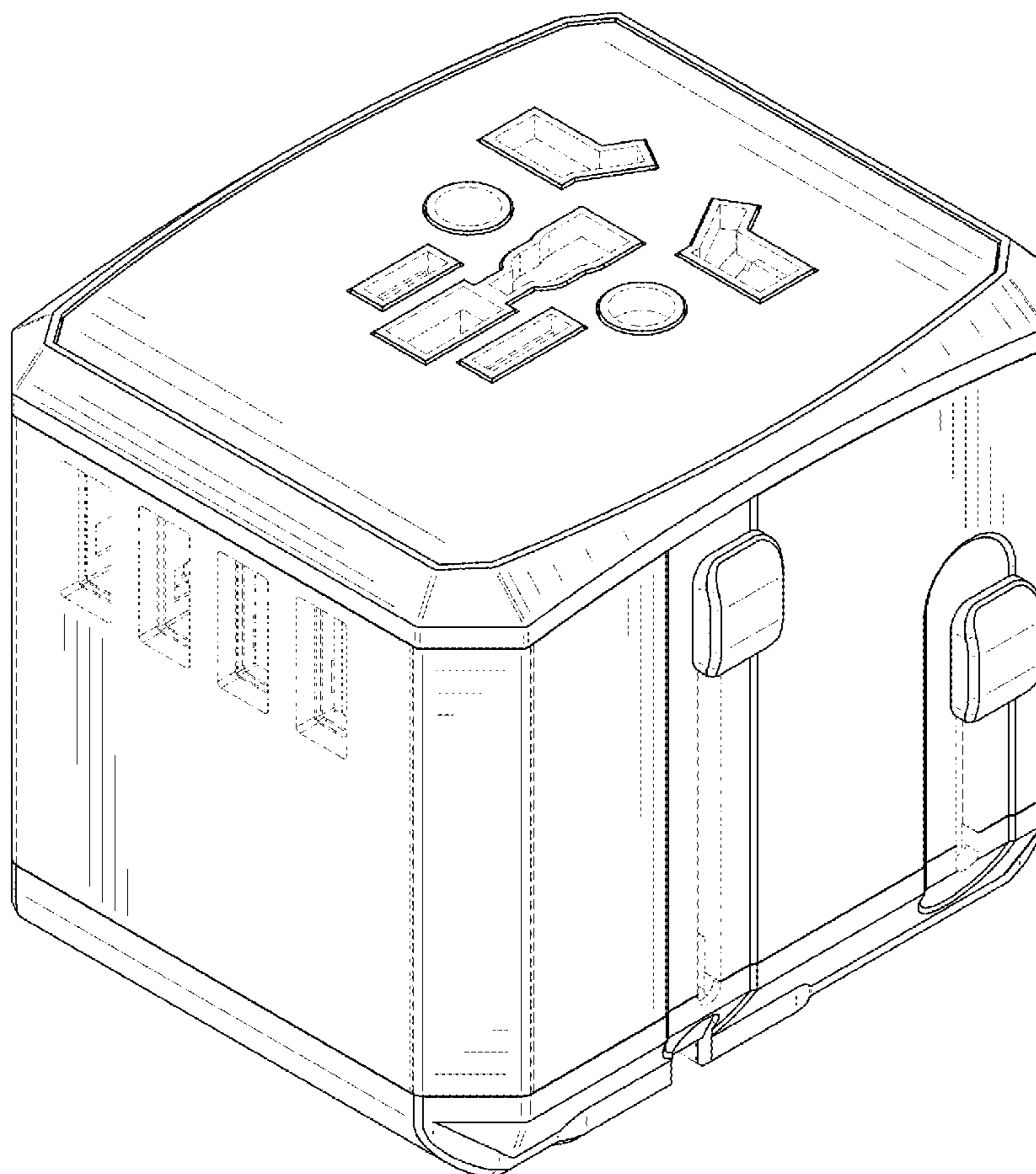

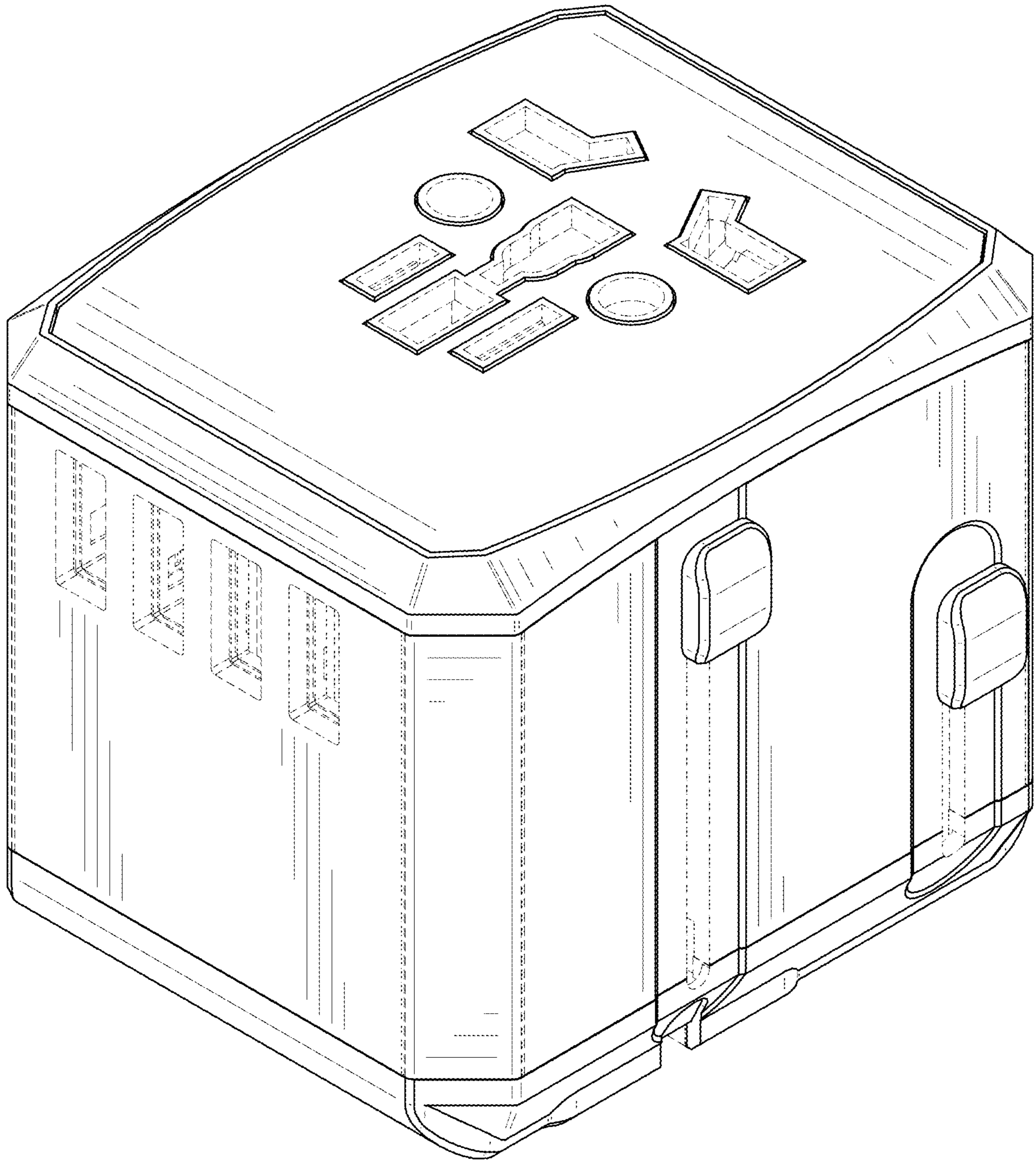

FIG. 1



FIG. 2

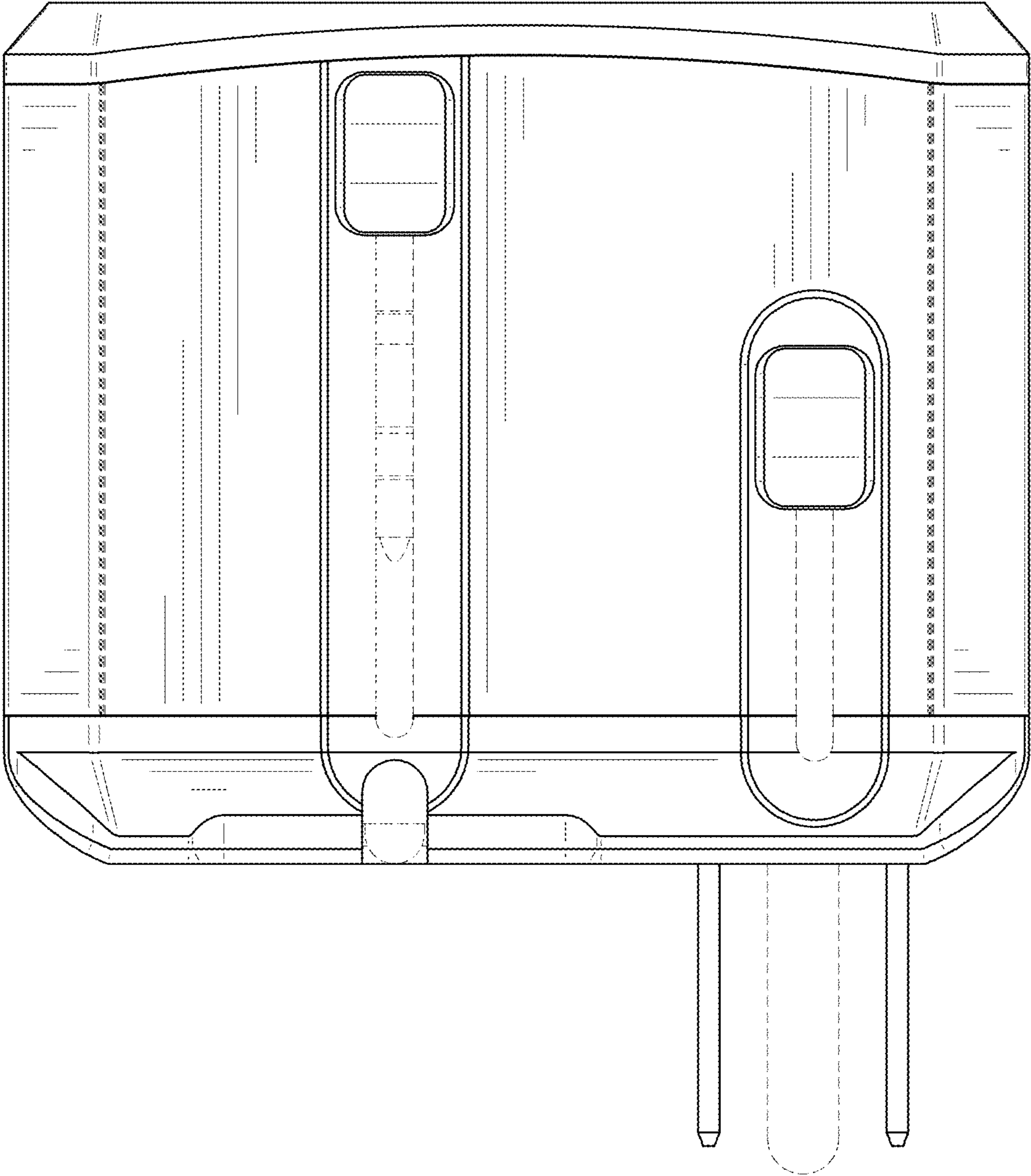

FIG. 3

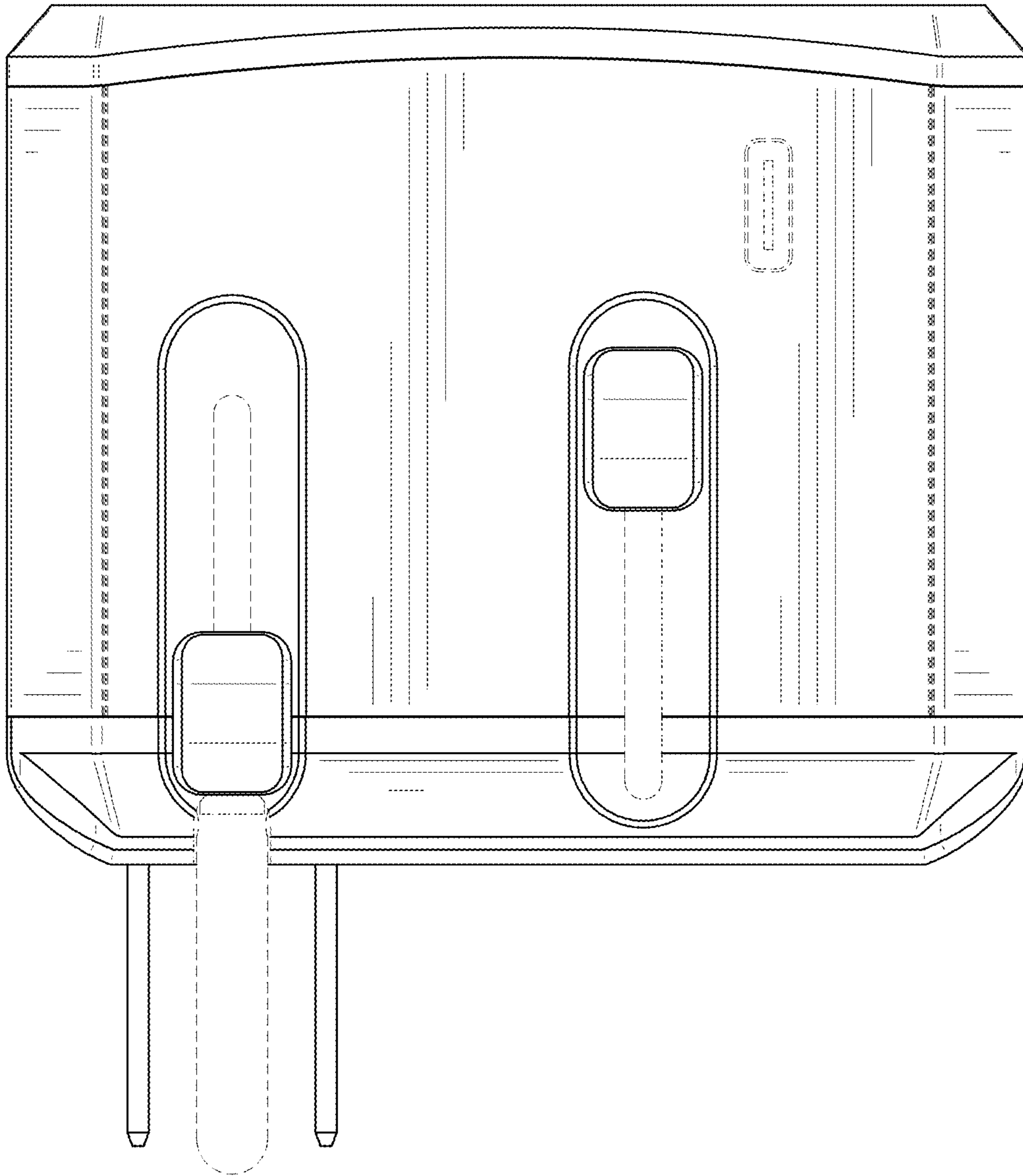

FIG. 4

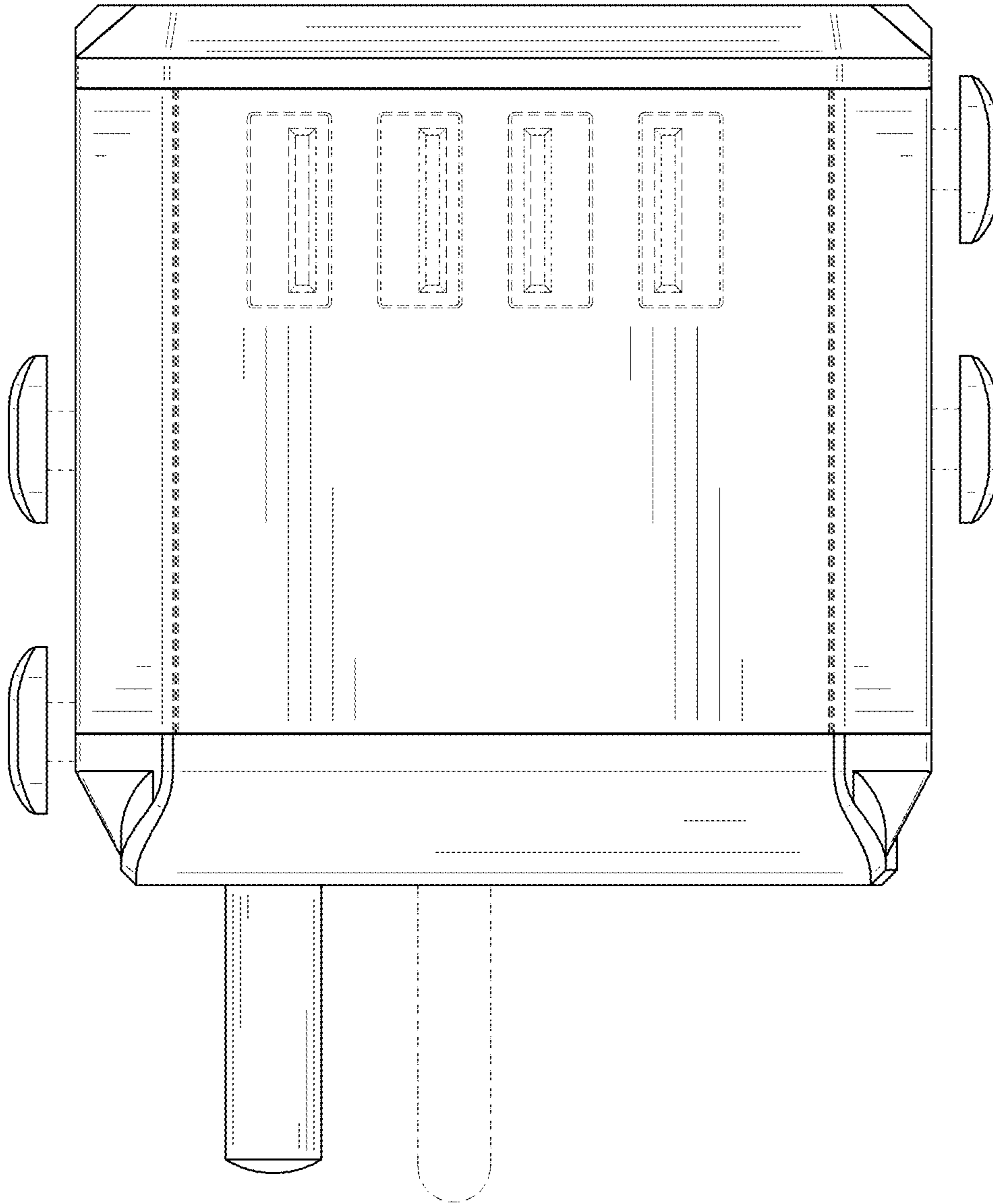

FIG. 5

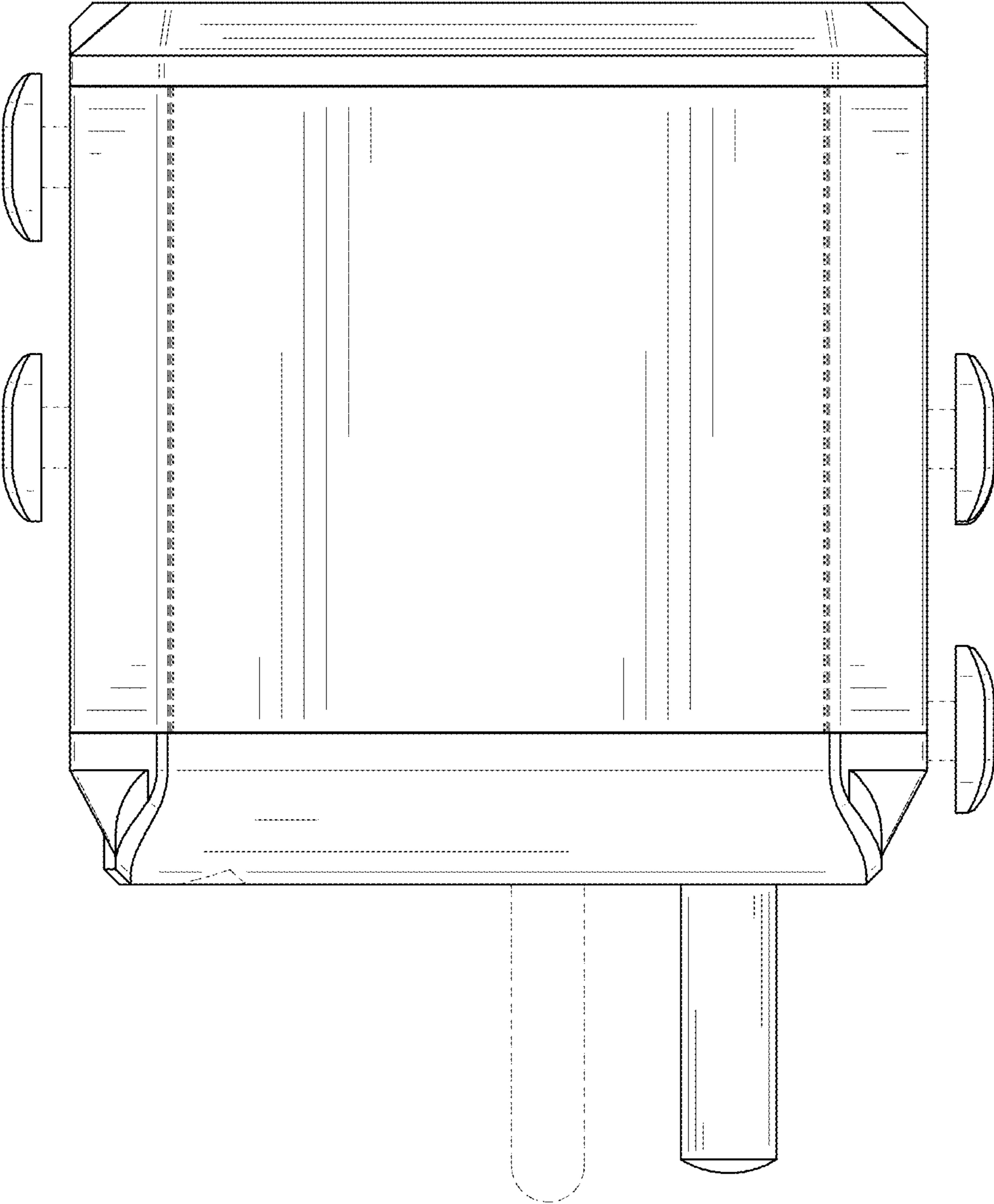

FIG. 6

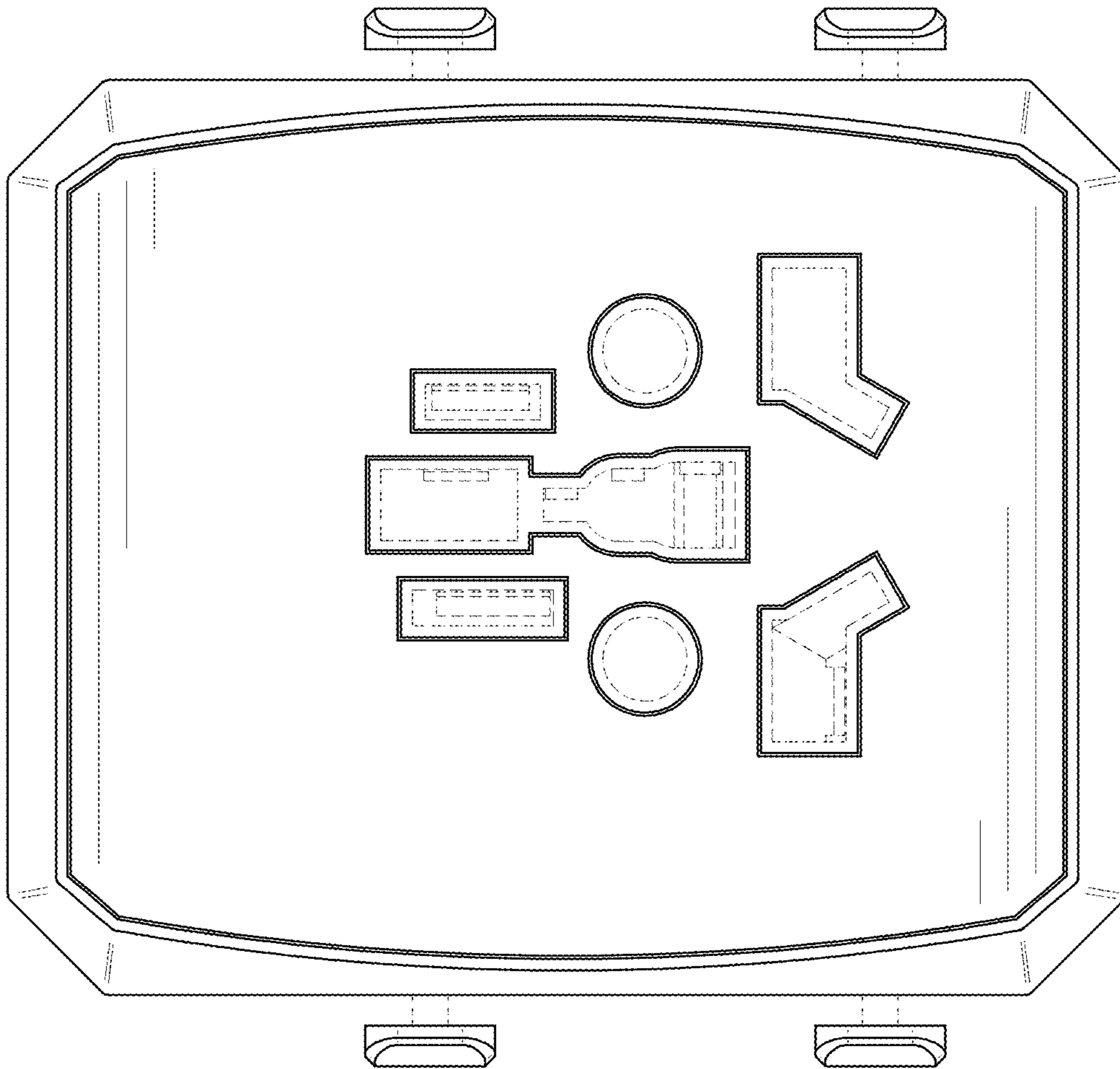

FIG. 7

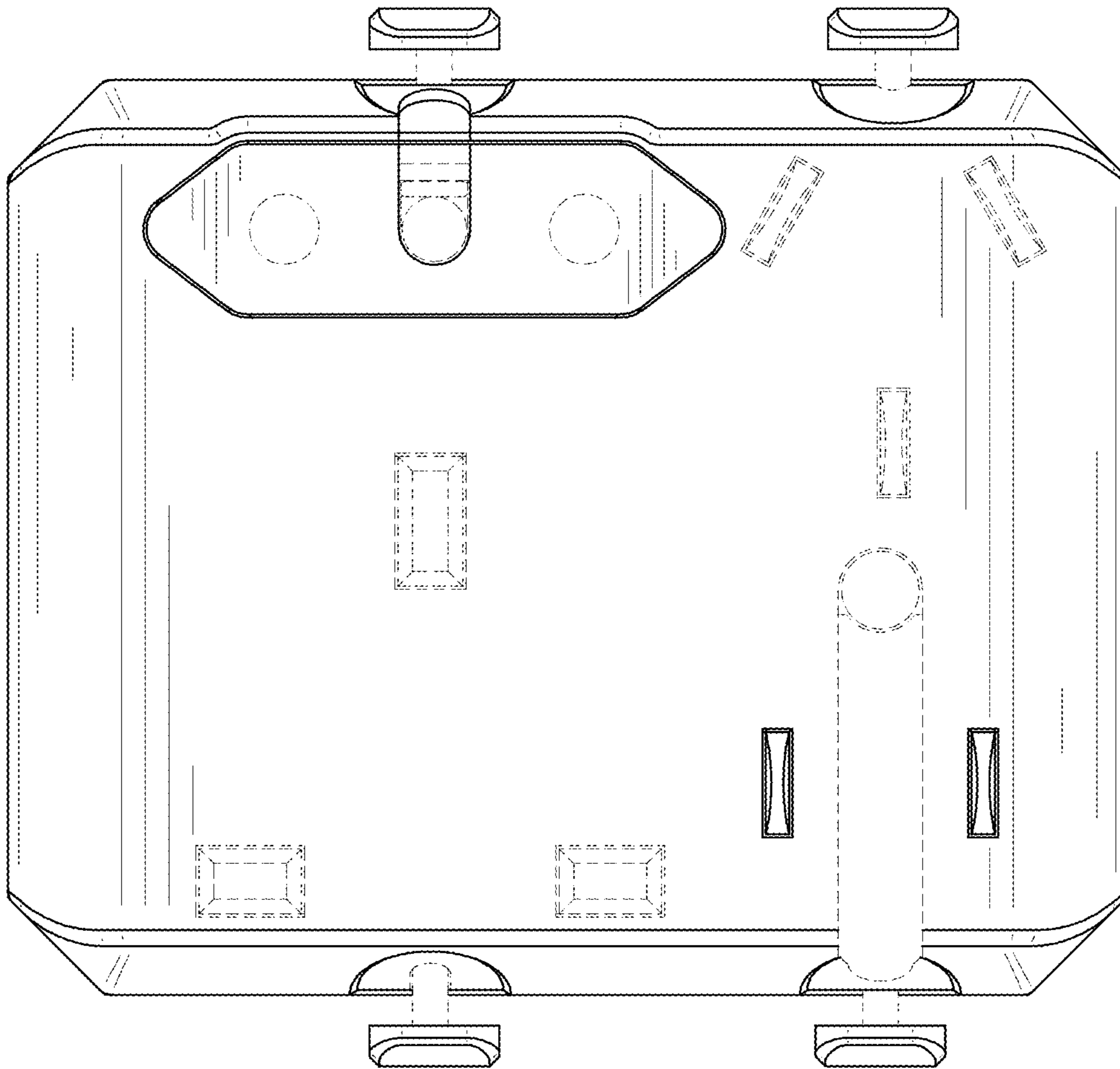

FIG. 8