



US00D934159S

(12) **United States Design Patent** (10) **Patent No.:** **US D934,159 S**
Dunn et al. (45) **Date of Patent:** **** Oct. 26, 2021**

(54) **CANOPY WITH SOLAR POWERED ELECTRONIC MENU BOARD**

(71) Applicant: **Manufacturing Resources International, Inc.**, Alpharetta, GA (US)

(72) Inventors: **William Dunn**, Alpharetta, GA (US); **Gerald Fraschilla**, Snellville, GA (US)

(73) Assignee: **Manufacturing Resources International, Inc.**, Alpharetta, GA (US)

(**) Term: **15 Years**

(21) Appl. No.: **29/711,255**

(22) Filed: **Oct. 29, 2019**

(51) **LOC (13) Cl.** **13-02**

(52) **U.S. Cl.**
USPC **D13/102**

(58) **Field of Classification Search**
USPC D13/102, 101, 103, 110, 118, 133, 182, D13/184, 199

CPC Y02E 10/40; Y02E 10/44; Y02E 10/50; Y02E 10/52; Y02E 10/542; Y02E 10/544; E04H 4/08; F24J 2/38; F24J 2/0472; F24J 2/542; H01L 31/00; H01L 31/042; H01L 31/045; H01L 31/048; H01L 31/049; H01L 31/052; H01L 31/184; H01L 31/0232; H01L 31/0508; H01L 31/0512; H01L 31/0543; H01L 31/02013; H01L 31/1876; H01L 51/0061; H02S 40/34

See application file for complete search history.

(56) **References Cited**

U.S. PATENT DOCUMENTS

4,534,496 A 8/1985 Bott
D311,722 S * 10/1990 Cheng D13/102
5,306,156 A 4/1994 Gibbs et al.

D514,913 S * 2/2006 Dunn D8/71
D595,645 S * 7/2009 Beghelli D13/102
D662,040 S * 6/2012 Yang D13/102
D710,298 S * 8/2014 Jie D13/102
D797,658 S * 9/2017 Feller D13/102
9,994,160 B2 6/2018 Kim et al.
2003/0119448 A1 6/2003 Arntz
2012/0002357 A1 1/2012 Auld et al.

(Continued)

FOREIGN PATENT DOCUMENTS

CN 106782121 A 5/2017
CN 109961695 A 7/2019

OTHER PUBLICATIONS

Vertigo Digital Displays, Innovation on Display FlexVu Totem Brochure, 2014, 6 pages.

(Continued)

Primary Examiner — Derrick E Holland

(74) *Attorney, Agent, or Firm* — Standley Law Group LLP; Jeffrey S. Standley; Adam J. Smith

(57) **CLAIM**

The ornamental design for a canopy with solar powered electronic menu board, as shown and described.

DESCRIPTION

FIG. 1 is a front perspective view of a canopy with solar powered electronic menu board;
FIG. 2 is a front elevation view thereof;
FIG. 3 is a rear elevation view thereof;
FIG. 4 is a right side elevation view thereof;
FIG. 5 is a left side elevation view thereof;
FIG. 6 is a top view thereof; and,
FIG. 7 is a bottom view thereof.

The broken lines shown represent environmental subject matter and form no part of the claimed design.

1 Claim, 7 Drawing Sheets

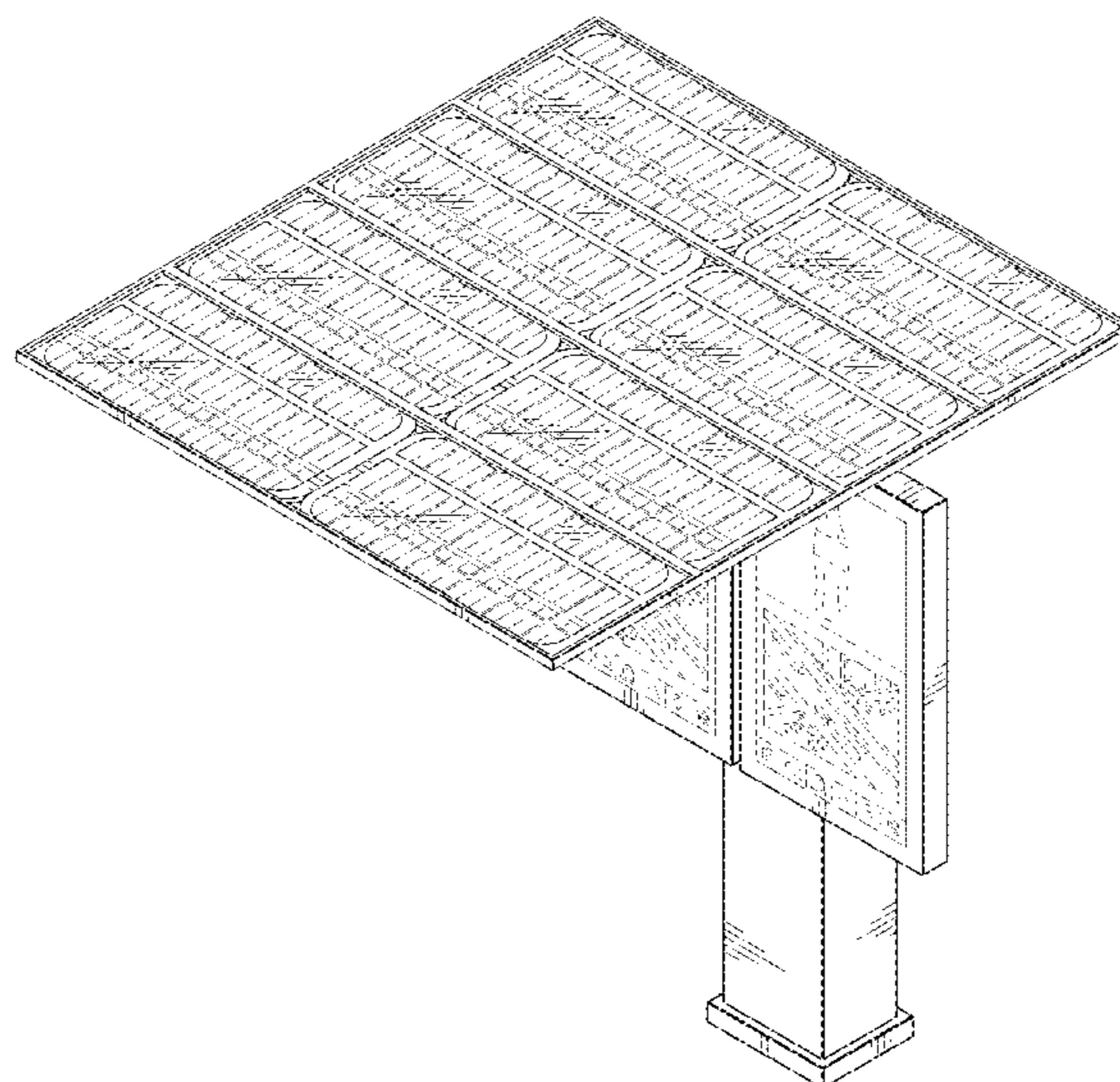

(56)

References Cited

U.S. PATENT DOCUMENTS

2012/0224116 A1 9/2012 Barnes
2018/0317330 A1* 11/2018 Dunn H05K 7/20736

OTHER PUBLICATIONS

Vertigo Digital Displays, FlexVu Totem Shelter, 2017, 2 pages.
Vertigo Digital Displays, All Products Catalogue, 2017, 14 pages.
CIVIQ Smartscapes, FlexVue Ferro 55P/55L, Mar. 16, 2017, 4 pages.
CIVIQ Smartscapes, There are companies that make kiosks. And then there's CIVIQ.—Advanced Smart City Platform, webpage, Jan. 30, 2019, 10 pages.
CIVIQ Smartscapes, Connecting people, places & experiences, webpage, Jan. 30, 2019, 5 pages.
CIVIQ Smartscapes, Connecting people, places & experiences, screen shot of devices webpage, Jan. 30, 2019, 1 page.

Manufacturing Resources International, Manufacturing Resources International home webpage, Nov. 4, 2019, 2 pages.
Manufacturing Resources International, LCD Display Deployments webpage, Nov. 2019, 3 pages.
Manufacturing Resources International, BoldVu Outdoor LCD Display webpage, Nov. 4, 2019, 2 pages.
Manufacturing Resources International, BoldVu Semi Outdoor LCD Display webpage, Nov. 8, 2019, 2 pages.
Manufacturing Resources International, BoldVu Vehicle Top LCD Display webpage, Nov. 8, 2019, 2 pages.
Manufacturing Resources International, Drivethru Menu Boards Webpage, Nov. 8, 2019, 2 pages.
Manufacturing Resources International, Storefront Digital Signage webpage, Nov. 8, 2019, 2 pages.
Melford Technologies, Part 1, video online at <https://m.youtube.com/watch?v=OAV7zzVrHtE&feature=youtu.be>, Oct. 21, 2019, 1 page.

* cited by examiner

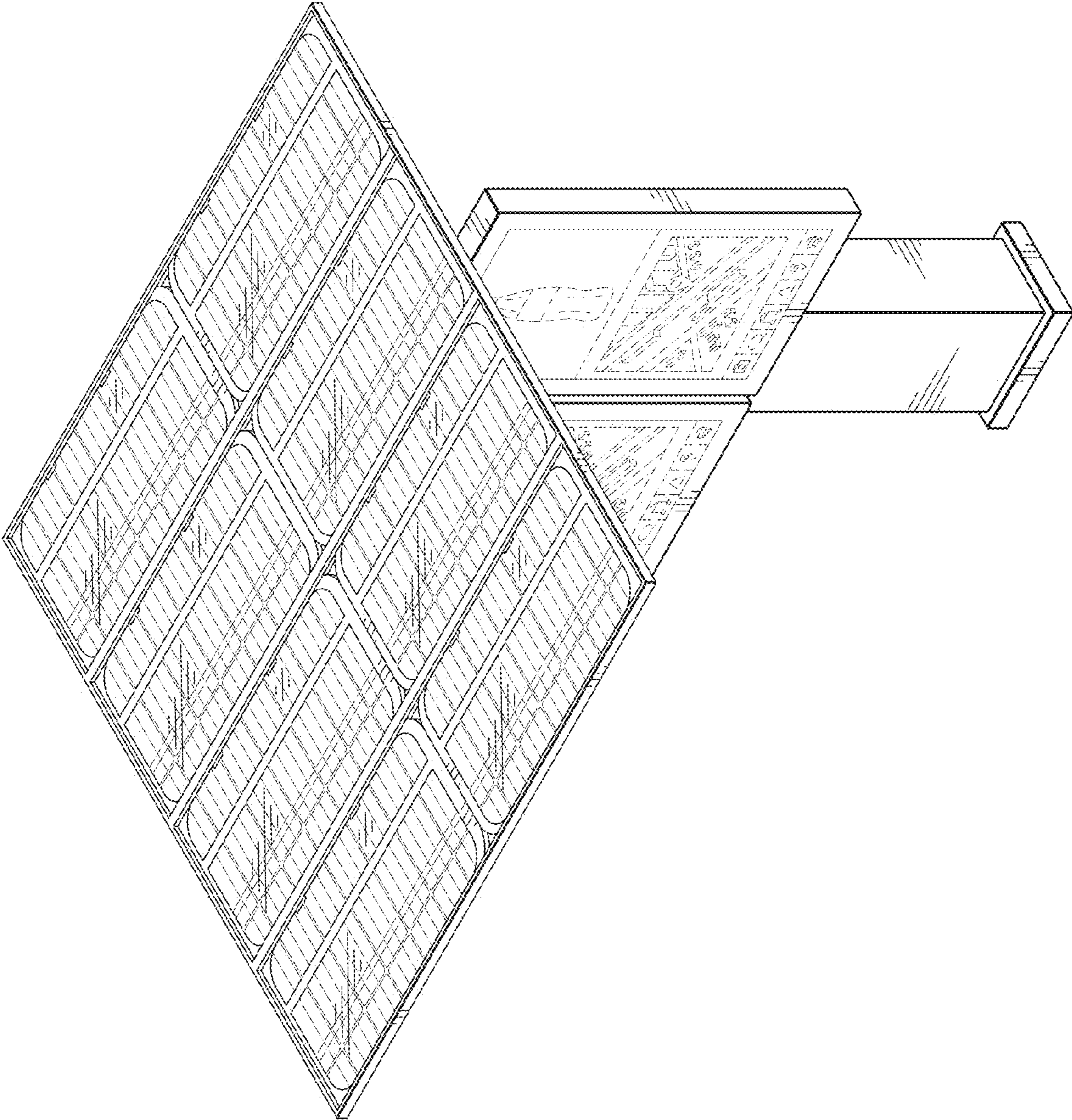

Fig. 1

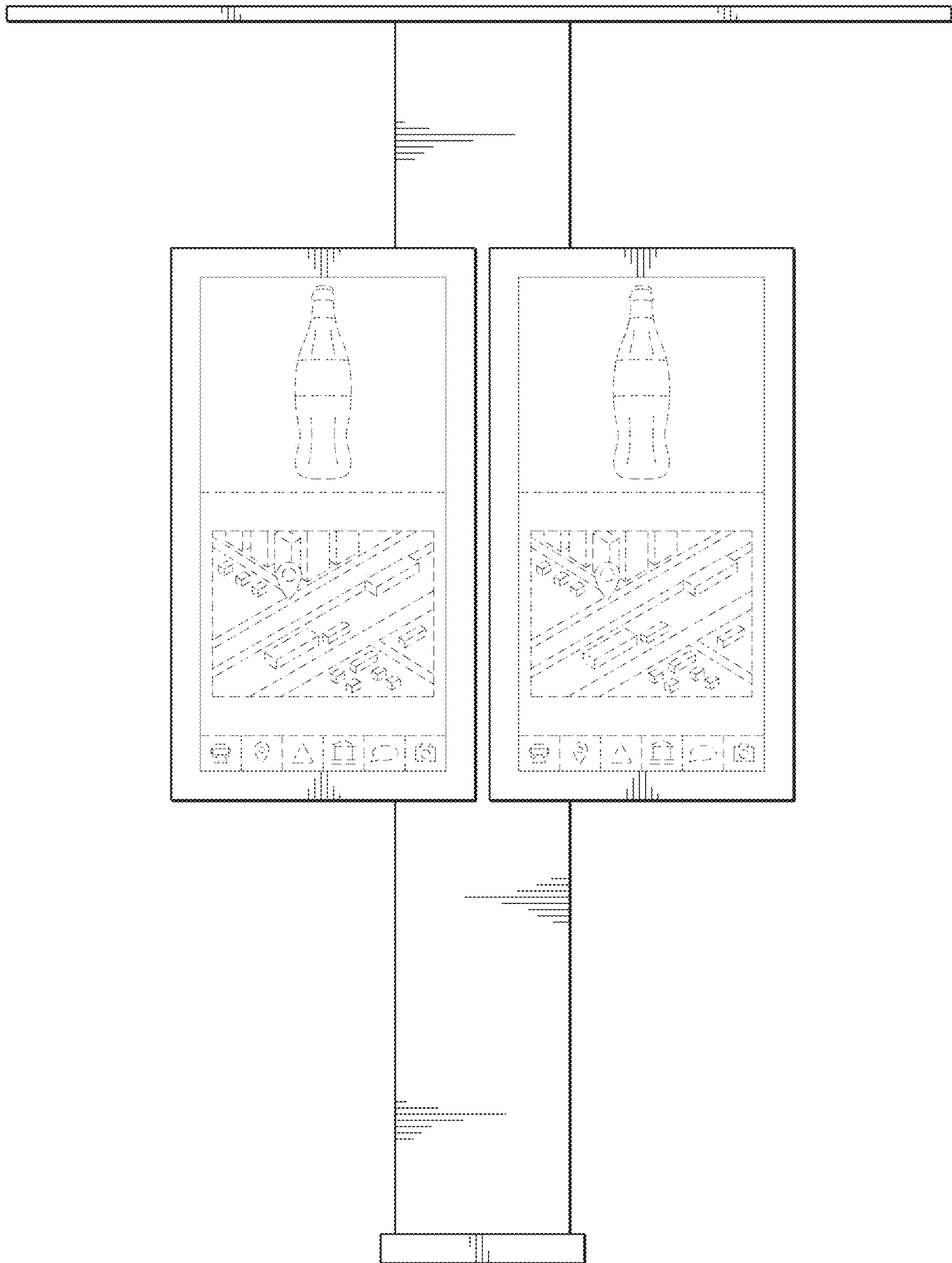

FIG. 2

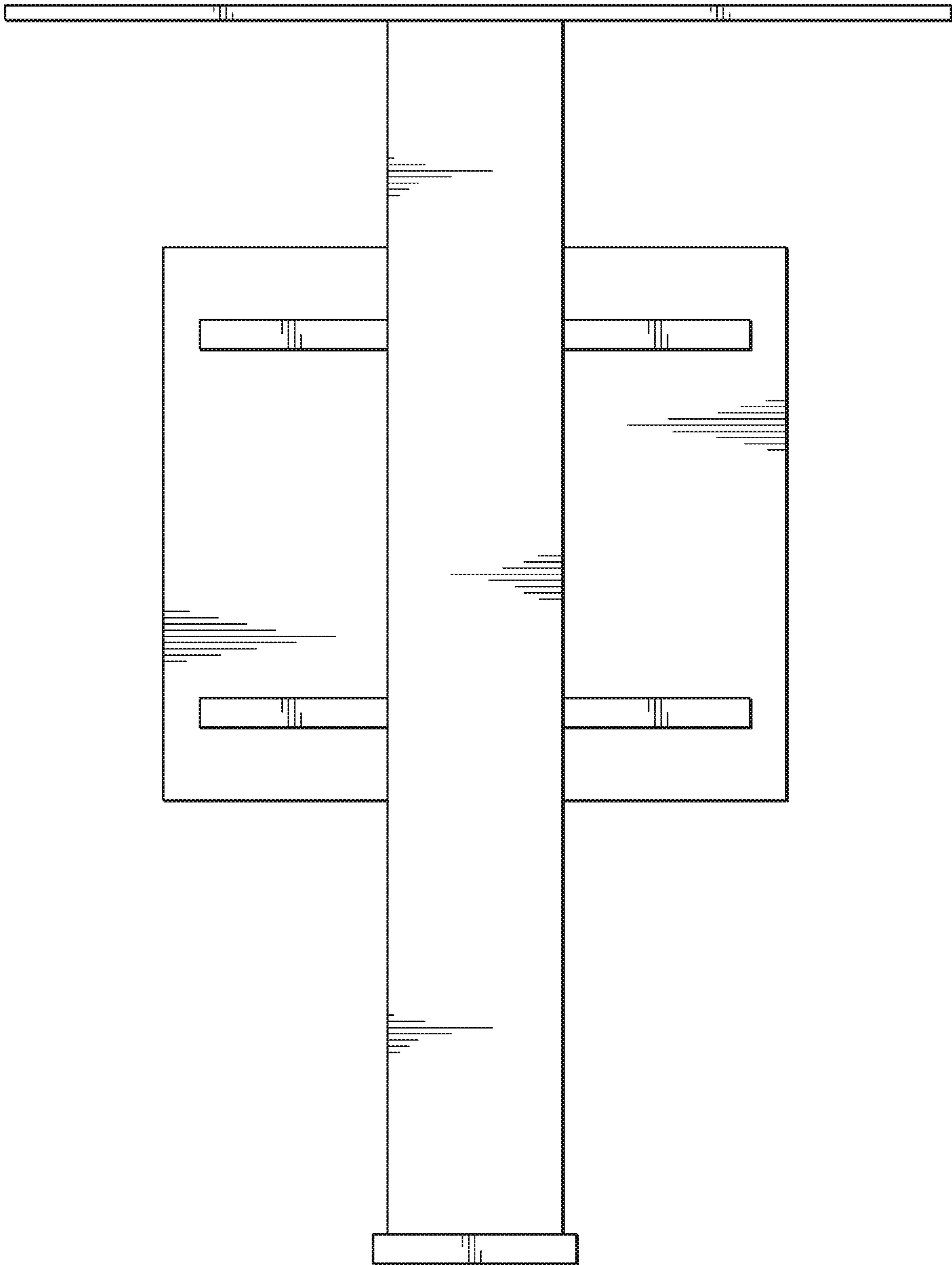

FIG. 3

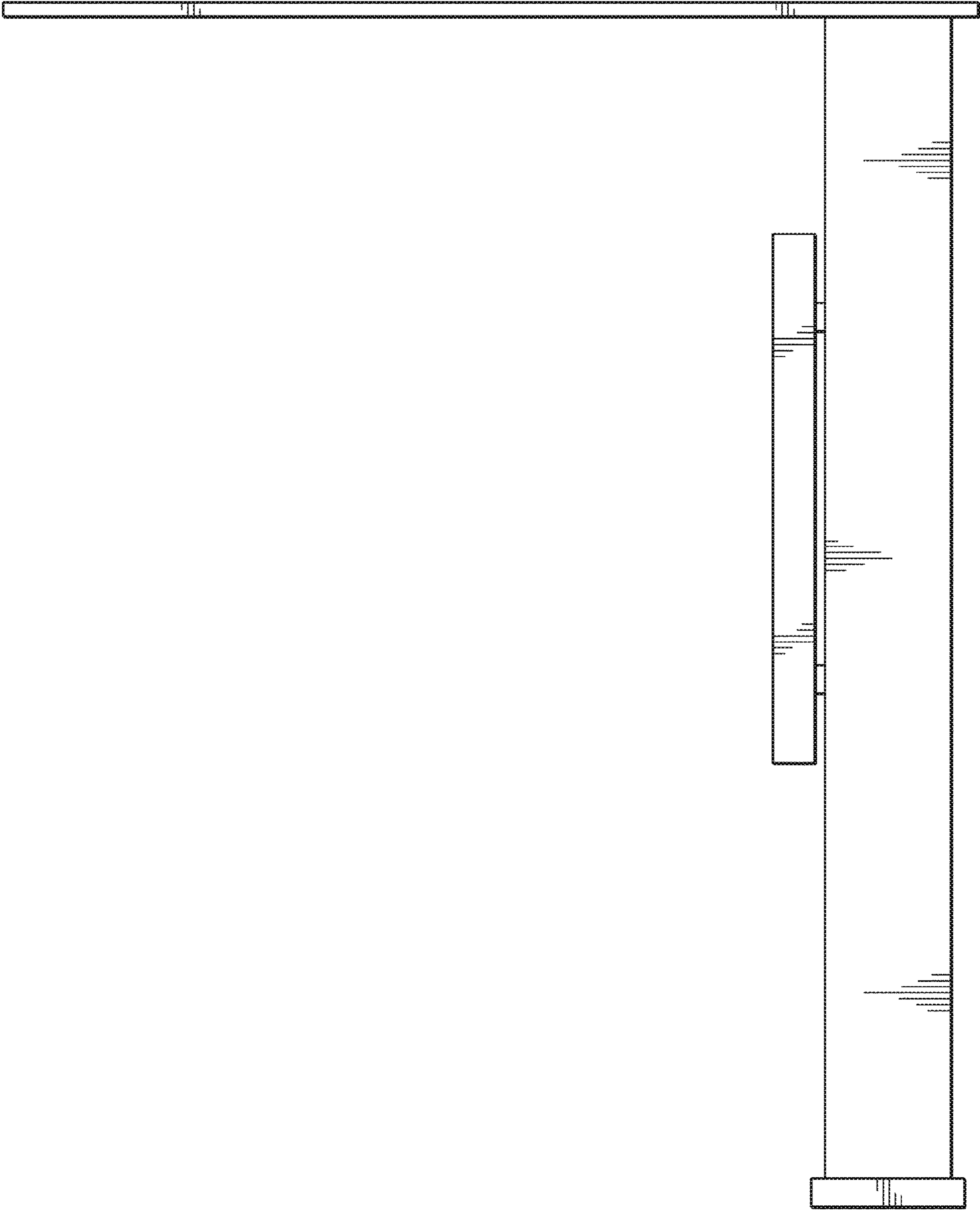

Fig. 4

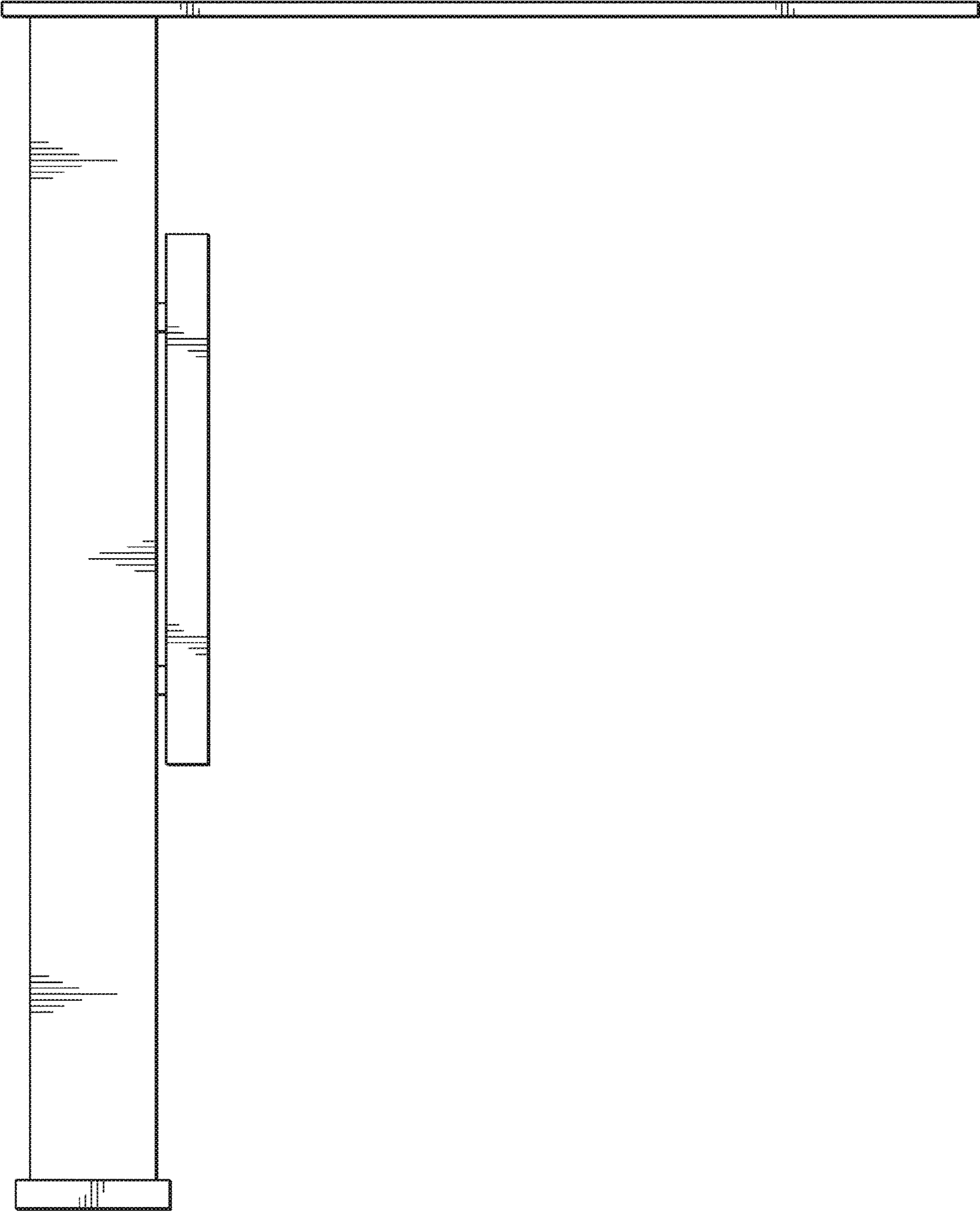

Fig. 5

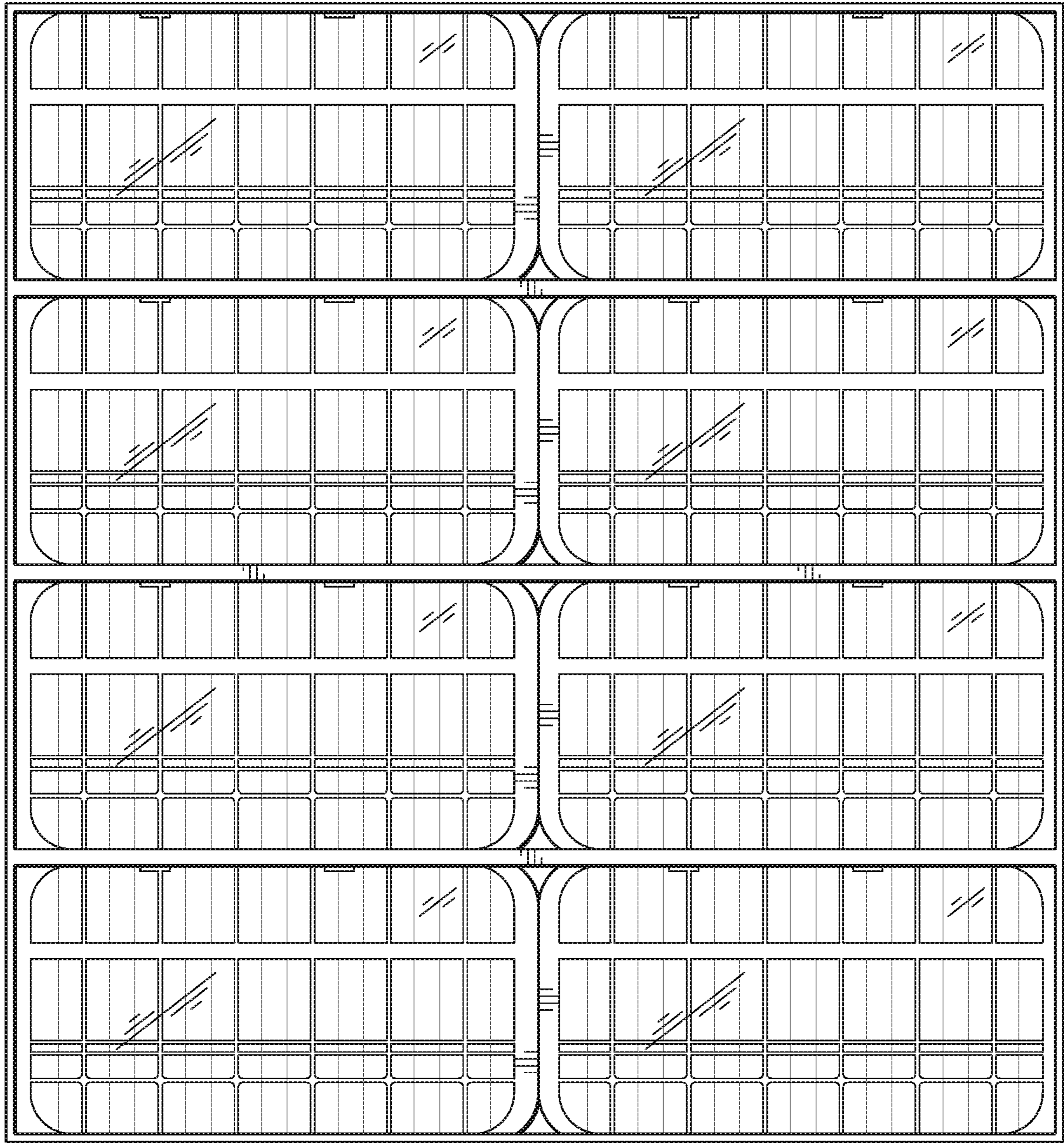

Fig. 6

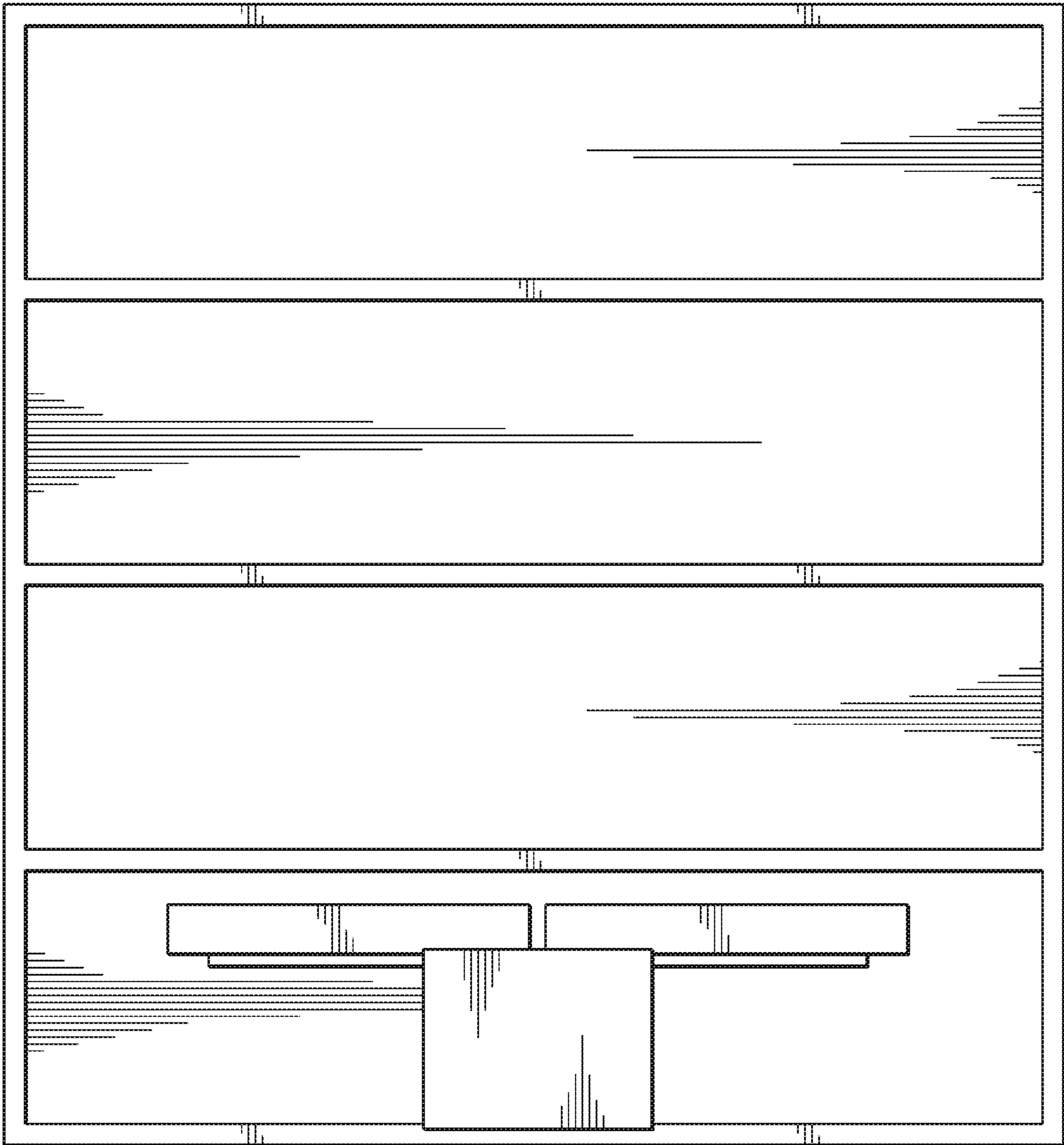

Fig. 7