



US00D934114S

(12) **United States Design Patent** (10) **Patent No.:** **US D934,114 S**  
**Karvandi** (45) **Date of Patent:** **\*\* Oct. 26, 2021**

(54) **BEVELED BUCKLE**  
(71) Applicant: **Orangutan Organization, Inc.**,  
Walpole, MA (US)  
(72) Inventor: **Kusha Karvandi**, Leander, TX (US)  
(73) Assignee: **Orangutan Organization, Inc.**,  
Walpole, MA (US)  
(\*\*) Term: **15 Years**  
(21) Appl. No.: **29/685,685**  
(22) Filed: **Mar. 29, 2019**  
(51) **LOC (13) Cl.** ..... **02-07**  
(52) **U.S. Cl.**  
USPC ..... **D11/216**  
(58) **Field of Classification Search**  
USPC ..... D21/804, 662; D8/44, 349, 356;  
D11/200-241; D16/311; D2/627-640;  
D10/32; D3/216; D24/169, 190;  
D29/100  
CPC ... A63B 33/00; A63B 33/002; A63B 21/4021;  
A63B 21/0552; A44B 17/0088; A44B  
13/0017; A44B 11/12; A44B 11/25; A44B  
11/125; A44B 11/2553; A44B 11/266;  
A44B 11/06; A44B 11/01; A44B 11/065;  
A44B 17/1327; A44B 17/1322; Y10T  
24/4016  
See application file for complete search history.

2,363,872 A 11/1944 Kiessling  
2,869,200 A \* 1/1959 Phillips ..... A44B 11/2526  
24/638  
2,893,394 A 7/1959 Wilhelm  
3,011,237 A \* 12/1961 Prete, Jr. .... B64D 25/06  
24/170  
3,042,986 A 7/1962 Racette et al.  
3,083,428 A 4/1963 McGill  
3,086,529 A 4/1963 Munz et al.  
3,100,484 A 8/1963 Berl  
(Continued)

**OTHER PUBLICATIONS**

Facebook Exerscribe Photos, Mar. 11, 2017, [online], [site visited Jul. 17, 2020]. Retrieved from url:https://www.facebook.com/exerscribe/photos/a.478392955590457/1250285948401150/ (Year: 2017).\*

(Continued)

*Primary Examiner* — Michelle E. Wilson  
*Assistant Examiner* — Tracey J Bell  
(74) *Attorney, Agent, or Firm* — Brooks Kushman P.C.

(57) **CLAIM**

The ornamental design for a beveled buckle, as shown and described.

**DESCRIPTION**

FIG. 1 is a perspective of a beveled buckle showing my new design;  
FIG. 2 is a front elevation view thereof;  
FIG. 3 is a back elevation view thereof;  
FIG. 4 is a left side elevation view thereof;  
FIG. 5 is a right side elevation view thereof;  
FIG. 6 is a top plan view thereof; and,  
FIG. 7 is a bottom plan view thereof.  
The portions of the figures illustrated in broken lines are provided for illustrative purposes only and form no part of the claimed design.

**1 Claim, 5 Drawing Sheets**

(56) **References Cited**  
U.S. PATENT DOCUMENTS  
40,911 A 12/1863 Cowles  
D55,826 S 7/1920 Stih  
1,447,967 A 3/1923 Rutledge  
1,771,689 A 7/1930 Arthur  
1,870,052 A 8/1932 Jones  
D92,333 S 5/1934 Botty  
2,009,325 A 7/1935 Morris  
2,234,961 A 3/1941 Canada

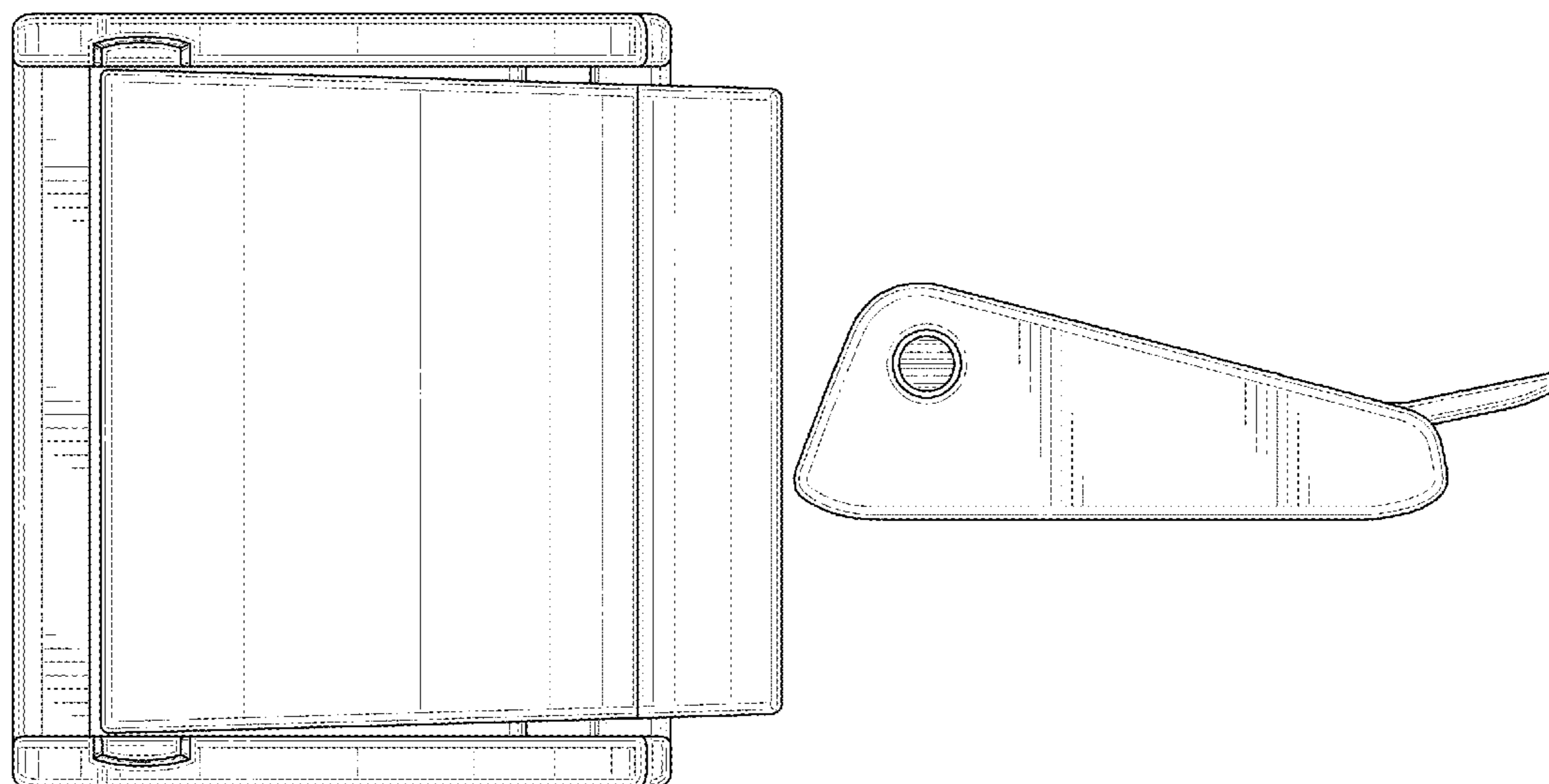

(56)

References Cited

U.S. PATENT DOCUMENTS

D215,195 S *	9/1969	Krengel	.....	D11/216	D462,772 S	9/2002	Lamping et al.
3,480,325 A *	11/1969	Kramer	.....	B60R 22/105	6,485,448 B2	11/2002	Lamping et al.
					D470,793 S	2/2003	Horn et al.
3,608,158 A *	9/1971	Bengtsson	.....	A44B 11/12	6,564,385 B2	5/2003	McCarthy
					D481,851 S	11/2003	Greaige
					D488,287 S	4/2004	Berger
3,641,630 A	2/1972	Farley			D488,288 S	4/2004	Eggers
D242,290 S	11/1976	Evans			D488,842 S	4/2004	Mills et al.
D243,293 S	2/1977	Scheimberg			D489,422 S *	5/2004	Feder ..... D21/662
4,184,617 A	1/1980	Lyon			D495,118 S	8/2004	Sherman
4,414,969 A	11/1983	Heyman			6,884,254 B2	4/2005	Brooks
D281,005 S	10/1985	Larsen			6,899,720 B1	5/2005	McMillan
4,631,784 A *	12/1986	Fildan	.....	A44B 11/12	D508,872 S *	8/2005	Hoepfner ..... D11/216
					D511,450 S	11/2005	Seth
					6,960,223 B1	11/2005	Ambach
4,733,440 A	3/1988	Ogawa			7,043,762 B2	5/2006	Greenhalgh
D300,810 S *	4/1989	Reaume	.....	D11/216	D529,896 S	10/2006	Anderson et al.
4,881,303 A	11/1989	Martini			D546,953 S	7/2007	Young
D304,977 S *	12/1989	Pappas	.....	D3/222	D547,228 S	7/2007	Rozsavolgyi
D311,232 S	10/1990	Drennan et al.			D558,427 S	1/2008	Solin
5,005,527 A	4/1991	Hatfield			D558,842 S	1/2008	Dore et al.
5,036,864 A *	8/1991	Yewer, Jr.	.....	A41F 9/002	D562,123 S *	2/2008	Jackson ..... D11/200
					7,334,301 B2	2/2008	Huang
					7,444,720 B2	11/2008	Huang
D322,854 S	12/1991	Campbell			7,468,067 B2	12/2008	Licata et al.
5,100,129 A *	3/1992	Porter	.....	A63B 21/0552	7,712,192 B2	5/2010	Lin et al.
					7,950,072 B1	5/2011	Hanson
					D647,279 S	10/2011	Shi et al.
5,141,223 A *	8/1992	Block	.....	A63B 21/0552	D648,440 S	11/2011	Allen
					D649,648 S	11/2011	Cavalieri et al.
					D650,485 S	12/2011	Jaccard
					D653,408 S	1/2012	Sajid
5,161,351 A	11/1992	Woodruff			D659,057 S	5/2012	Patton et al.
D333,626 S	3/1993	Chang			D659,570 S	5/2012	Hetke et al.
D333,640 S *	3/1993	Keller	.....	D11/200	D662,557 S	6/2012	Nawracaj
5,254,065 A	10/1993	Pollock			D676,627 S	2/2013	Doss
5,269,050 A *	12/1993	Yewer, Jr.	.....	A44B 11/12	8,439,943 B2	5/2013	Chao
					8,486,106 B2	7/2013	Warburton
					8,561,267 B2	10/2013	Chang
5,279,057 A	1/1994	Melin et al.			D697,712 S	1/2014	Morton
5,291,638 A	3/1994	Huang			8,635,746 B2	1/2014	Bellamy et al.
D346,482 S	5/1994	Merrill			8,747,284 B2	6/2014	Ingram
D350,401 S	9/1994	Kok			D707,917 S	7/2014	James et al.
5,432,951 A *	7/1995	Yewer, Jr.	.....	A41F 9/002	D710,739 S	8/2014	Miller
					D712,555 S	9/2014	Berg
					8,821,425 B2	9/2014	Cox
5,500,959 A *	3/1996	Yewer, Jr.	.....	A61F 5/028	8,834,331 B1	9/2014	Boatwright
					8,887,313 B2	11/2014	McGuin
					D726,841 S	4/2015	Wright
D369,674 S	5/1996	Schreiner et al.			D733,525 S	7/2015	Petzl
D373,011 S	8/1996	Rippel			D742,461 S *	11/2015	Baldwin ..... D21/662
D373,803 S	9/1996	Winans			D747,176 S	1/2016	Petzl
5,551,447 A	9/1996	Hoffman et al.			D747,591 S	1/2016	Holloway et al.
D383,993 S	9/1997	Kalbach			D749,568 S	2/2016	Magi et al.
5,661,877 A	9/1997	Bloomer			D750,716 S	3/2016	Pouliot
5,685,787 A	11/1997	Kogut			D751,065 S	3/2016	Magi
D389,987 S	2/1998	O'Byrne et al.			D753,244 S	4/2016	Hovey
D390,492 S	2/1998	Riley			D753,344 S	4/2016	Kantor
D393,337 S	4/1998	Seki			D753,892 S	4/2016	Hutchinson
5,740,591 A *	4/1998	Hopkins	.....	A44B 11/12	9,339,693 B1	5/2016	Pegram et al.
					D759,993 S	6/2016	Stinson
					D761,924 S	7/2016	Sato
5,745,920 A	5/1998	Olivier			9,380,817 B1	7/2016	Drake
5,746,685 A	5/1998	Glaser			D788,859 S	6/2017	Virtusio
D397,838 S	9/1998	Waggoner et al.			D793,671 S	8/2017	Grenville
5,816,984 A	10/1998	Weiss			D794,490 S	8/2017	Lindgren
5,888,180 A	3/1999	Dewberry			D800,991 S	10/2017	Gordon
D422,709 S *	4/2000	Caswell	.....	D2/624	D810,843 S *	2/2018	Karvandi ..... D21/662
6,049,953 A	4/2000	McCay et al.			D810,962 S	2/2018	McGowan et al.
D427,651 S	7/2000	Bodman			D815,390 S	4/2018	Adrianse
6,081,925 A	7/2000	Reiber			D819,218 S	5/2018	Inzer
D432,446 S	10/2000	Santos			D827,057 S	8/2018	Piotrowski et al.
D433,227 S	11/2000	Evans			D828,467 S	9/2018	Karvandi
6,149,618 A	11/2000	Sato			D828,688 S	9/2018	Hogard et al.
D437,623 S	2/2001	Ormsby			10,070,701 B1	9/2018	Liu
D441,413 S	5/2001	Cataldi, Jr. et al.			10,117,472 B2	11/2018	Robbins
D449,136 S	10/2001	Vallance			10,130,162 B2	11/2018	Tang
D453,366 S	2/2002	French			10,194,917 B1	2/2019	Carson et al.
6,349,493 B1	2/2002	Newman et al.			D841,935 S	3/2019	Dennard
6,352,074 B1	3/2002	Okada					
D455,213 S	4/2002	Weaver et al.					
D457,688 S	5/2002	Cordero					
6,381,810 B2	5/2002	Hsieh					
6,398,749 B1	6/2002	Slautterback					

(56)

References Cited

U.S. PATENT DOCUMENTS

D843,525	S	3/2019	Karvandi	
10,245,460	B2	4/2019	Hetrick et al.	
D847,468	S	5/2019	Genao	
D849,361	S	5/2019	Mouquet	
D850,546	S	6/2019	Reese	
D853,501	S *	7/2019	Karvandi	..... D21/662
D856,444	S	8/2019	Karvandi	
D858,938	S	9/2019	He	
D868,270	S	11/2019	Nadeau	
10,463,905	B1	11/2019	Smith, Jr.	
D870,218	S	12/2019	Sudell	
D872,200	S	1/2020	Antezana	
10,568,636	B2	2/2020	Demas et al.	
D877,451	S	3/2020	Ardit	
10,583,971	B2	3/2020	Kruzel	
D893,830	S	8/2020	Scott et al.	
D895,931	S *	9/2020	Motteli	..... D2/731
2001/0022013	A1 *	9/2001	Hsieh	..... A44B 11/06 24/170
2002/0107119	A1	8/2002	Porter	
2002/0160891	A1	10/2002	Gallagher	
2003/0019080	A1	1/2003	Anthony et al.	
2003/0148861	A1	8/2003	McBride	
2003/0177561	A1	9/2003	Sloot	
2006/0025807	A1	2/2006	Licata et al.	
2006/0089668	A1	4/2006	Warburton	
2007/0032359	A1	2/2007	Toronto	
2007/0193004	A1	8/2007	Chou	
2008/0120755	A1	5/2008	Ingram et al.	
2008/0148529	A1	6/2008	Huang	
2008/0216213	A1	9/2008	Lin et al.	
2008/0312682	A1	12/2008	Shams et al.	
2009/0183299	A1	7/2009	Conway	
2010/0217307	A1	8/2010	Warburton	
2010/0312271	A1	12/2010	Chao	
2011/0125036	A1	5/2011	Nakajima et al.	
2011/0247179	A1	10/2011	Bellamy et al.	
2011/0313435	A1	12/2011	Aldridge et al.	
2013/0331236	A1	12/2013	Moss	
2014/0213420	A1	7/2014	Harris	
2015/0052655	A1	2/2015	McCully	
2015/0158615	A1	6/2015	Downs	
2016/0174665	A1	6/2016	Kung	
2016/0317864	A1	11/2016	Sato	
2017/0000249	A1	1/2017	Beck	
2017/0274236	A1	9/2017	Farias	
2017/0354422	A1	12/2017	Brub	
2018/0020781	A1	1/2018	McNeill	
2018/0042616	A1	2/2018	Demas et al.	
2018/0140929	A1	5/2018	Pellegrino	
2018/0154818	A1	6/2018	Sauerwald	
2018/0273263	A1	9/2018	Kruzel	

2019/0060700	A1	2/2019	Abecasis
2019/0076153	A1	3/2019	Karvandi
2019/0274693	A1	9/2019	Carson et al.
2019/0314036	A1	10/2019	Huang
2020/0171342	A1	6/2020	Peery

OTHER PUBLICATIONS

Youtube PRO X and PRO BFR Bands Comparison, Oct. 20, 2017, [online], [site visited Jul. 17, 2020]. Retrieved from url:<https://www.youtube.com/watch?v=ZhoF-Vwrs-A> (Year: 2017).\*

Youtube PRO Premium BFR Bands Trailer, Oct. 21, 2019, [online], [site visited Jul. 17, 2020]. Retrieved from url:[https://www.youtube.com/watch?v=AspbWrkLey8&feature=emb\\_logo](https://www.youtube.com/watch?v=AspbWrkLey8&feature=emb_logo) (Year: 2019).\*

Amazon Occlusion Training Bands, [online], [site visited Feb. 24, 2017]. Available from Internet, URL <https://www.amazon.com/dp/B00ZJTEM1U>.

Amazon, "Occlusion Training Bands", Feb. 3, 2018. <https://www.amazon.com/Occlusion-Training-Bands-BFR-Restriction/dp/B0777QRRH> H?ref\_=ast\_sto\_dp. Shown on p. 1. (Year: 2018).

Amazon, "BFR Training Bands", Jul. 27, 2018. [https://www.amazon.com/BFR-BANDS-Occlusion-Restriction-Quick-Release/dp/B07D9V4TWJ/ref=cm\\_cr\\_ar\\_p\\_d\\_product\\_top?ie=UTF8](https://www.amazon.com/BFR-BANDS-Occlusion-Restriction-Quick-Release/dp/B07D9V4TWJ/ref=cm_cr_ar_p_d_product_top?ie=UTF8). Shown on p. 1. (Year: 2018).

Bear Grips by Bear Grips dated Jan. 3, 2015. Found online [Dec. 6, 2018]. [https://www.amazon.com/Bear-Grips-II-band-support-lifting/dp/B00OPW9W3U/ref=cm\\_erarp\\_d\\_product\\_top?ie=UTF8](https://www.amazon.com/Bear-Grips-II-band-support-lifting/dp/B00OPW9W3U/ref=cm_erarp_d_product_top?ie=UTF8).

BFR Bands by BFR Bands dated Oct. 31, 2015. Found online [Dec. 6, 2018]. [https://www.amazon.com/BFR-Occlusion-Training-Restriction-Quick-Release/dp/B01C2BAE82/ref=cm\\_cr\\_ar\\_p\\_d\\_product\\_top?ie=UTF8](https://www.amazon.com/BFR-Occlusion-Training-Restriction-Quick-Release/dp/B01C2BAE82/ref=cm_cr_ar_p_d_product_top?ie=UTF8).

BFR Bands, [online], [site visited Jan. 25, 2017]. Available from Internet, URL: <http://www.bfrbands.com/>.

Elite 2.0 BFR Bands, [online], [site visited Jan. 25, 2017]. Available from Internet, URL: <http://www.occlusiontrainingbands.com/product/elite-bfr-bands/>.

Occlusion Training Bands by Exerscribe dated Mar. 5, 2015. Found online [Dec. 6, 2018]. [https://www.amazon.com/Occlusion-Training-Restriction-without-Lifting/product-reviews/BOOZHJ8DYE/ref=cm\\_ergetr\\_d\\_paging\\_btm\\_8?ie=UTF8&reviewerType=all\\_reviews&sortBy=recent&pageNumber=8](https://www.amazon.com/Occlusion-Training-Restriction-without-Lifting/product-reviews/BOOZHJ8DYE/ref=cm_ergetr_d_paging_btm_8?ie=UTF8&reviewerType=all_reviews&sortBy=recent&pageNumber=8).

Quad by BFR dated no date given. Found online [Dec. 6, 2018]. <https://www.bfrshop.com/collections/lower-body-bands/products/quad-wrap-occlusion-training-bands>.

Quad Wraps by BFR Bands dated Oct. 13, 2017. Found online [Dec. 6, 2018]. [https://www.youtube.com/watch?time\\_continue=48&v=vQ6aKg08taA](https://www.youtube.com/watch?time_continue=48&v=vQ6aKg08taA).

Youtube, "BFR Bands Rigid Edition Arm Bands", Apr. 29, 2020. <https://www.youtube.com/watch?v=1aPar6efLc4>. Shown at the 0:07 minute mark. (Year: 2020).

\* cited by examiner

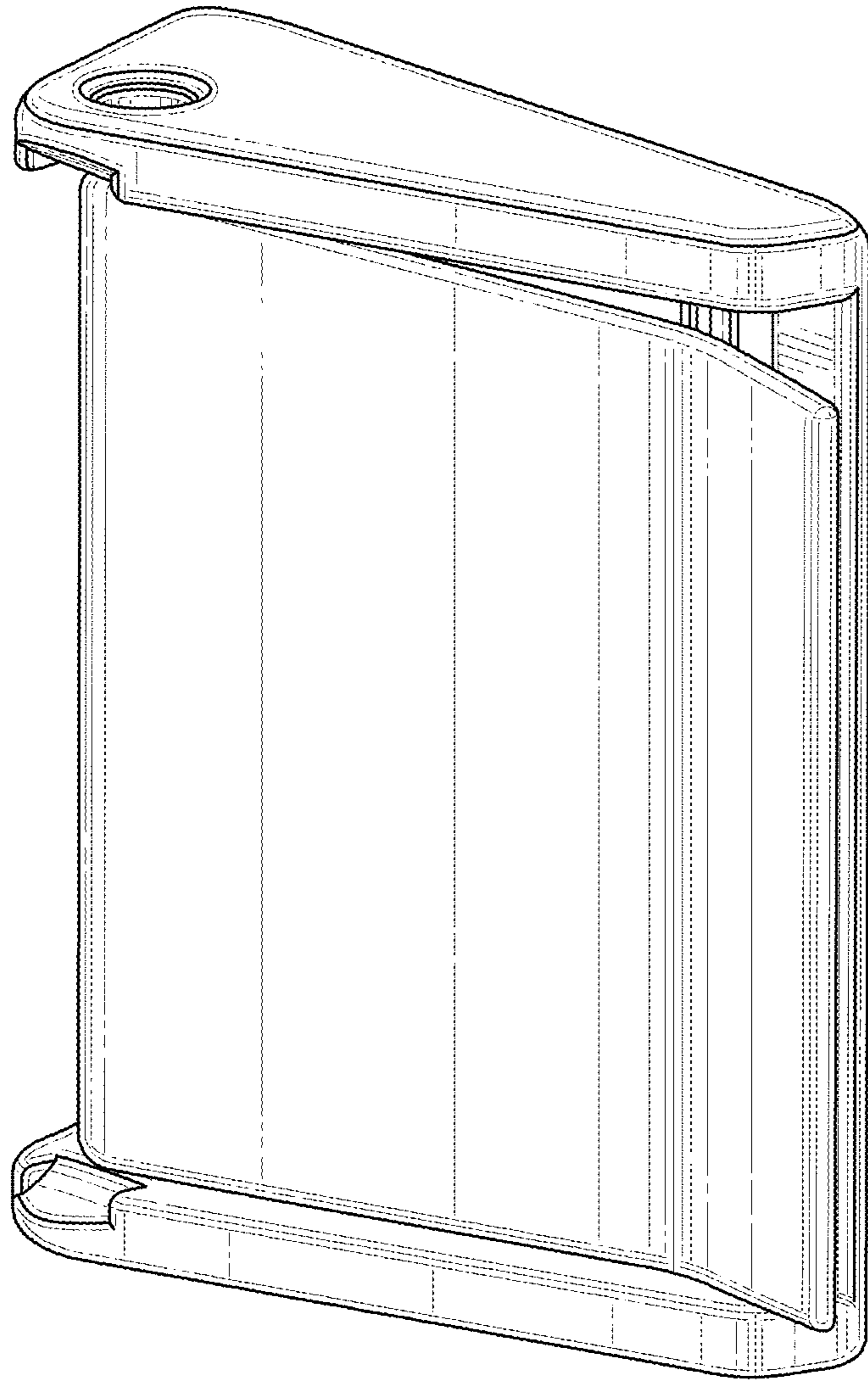

*FIG. 1*

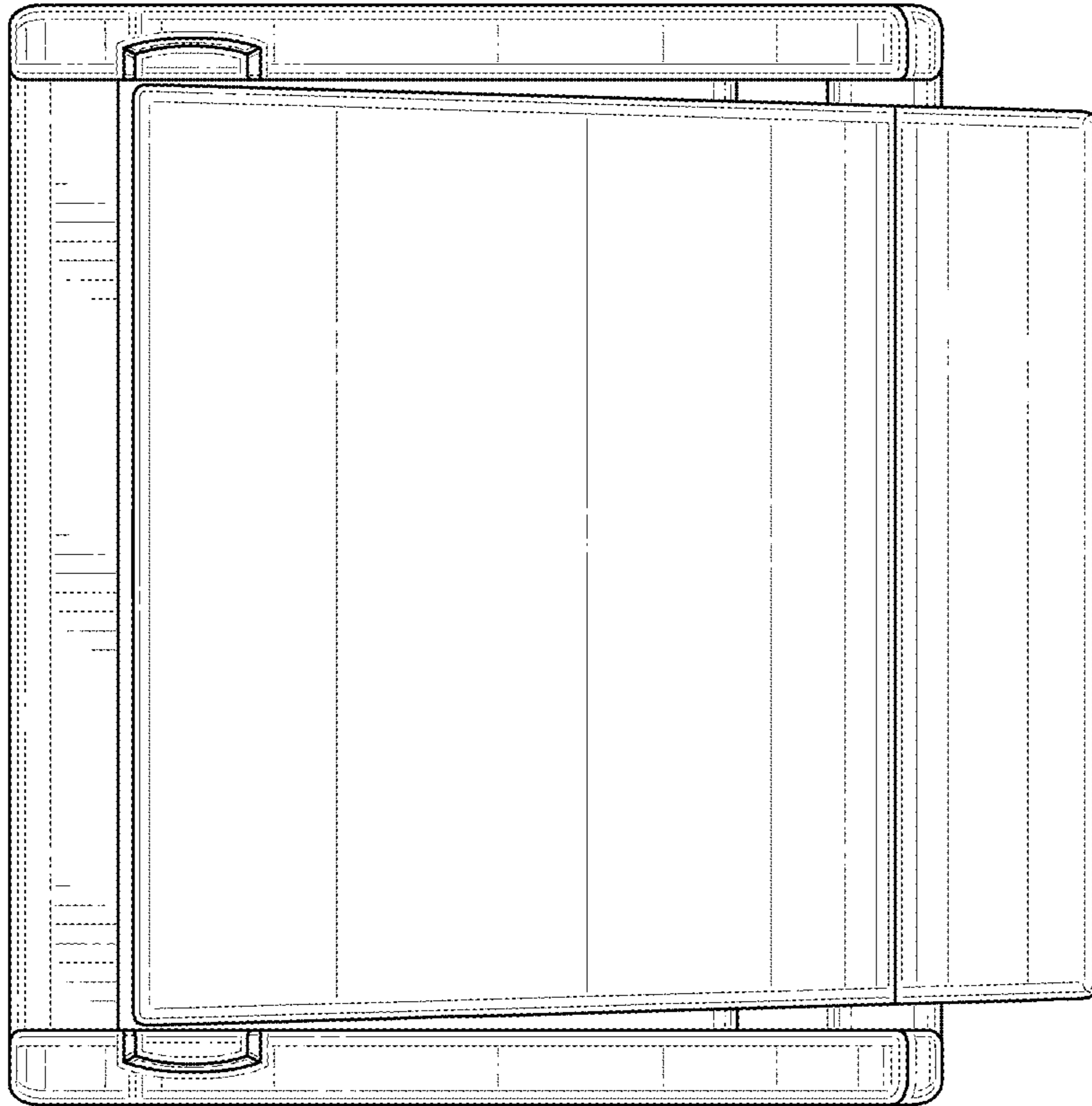

FIG. 2

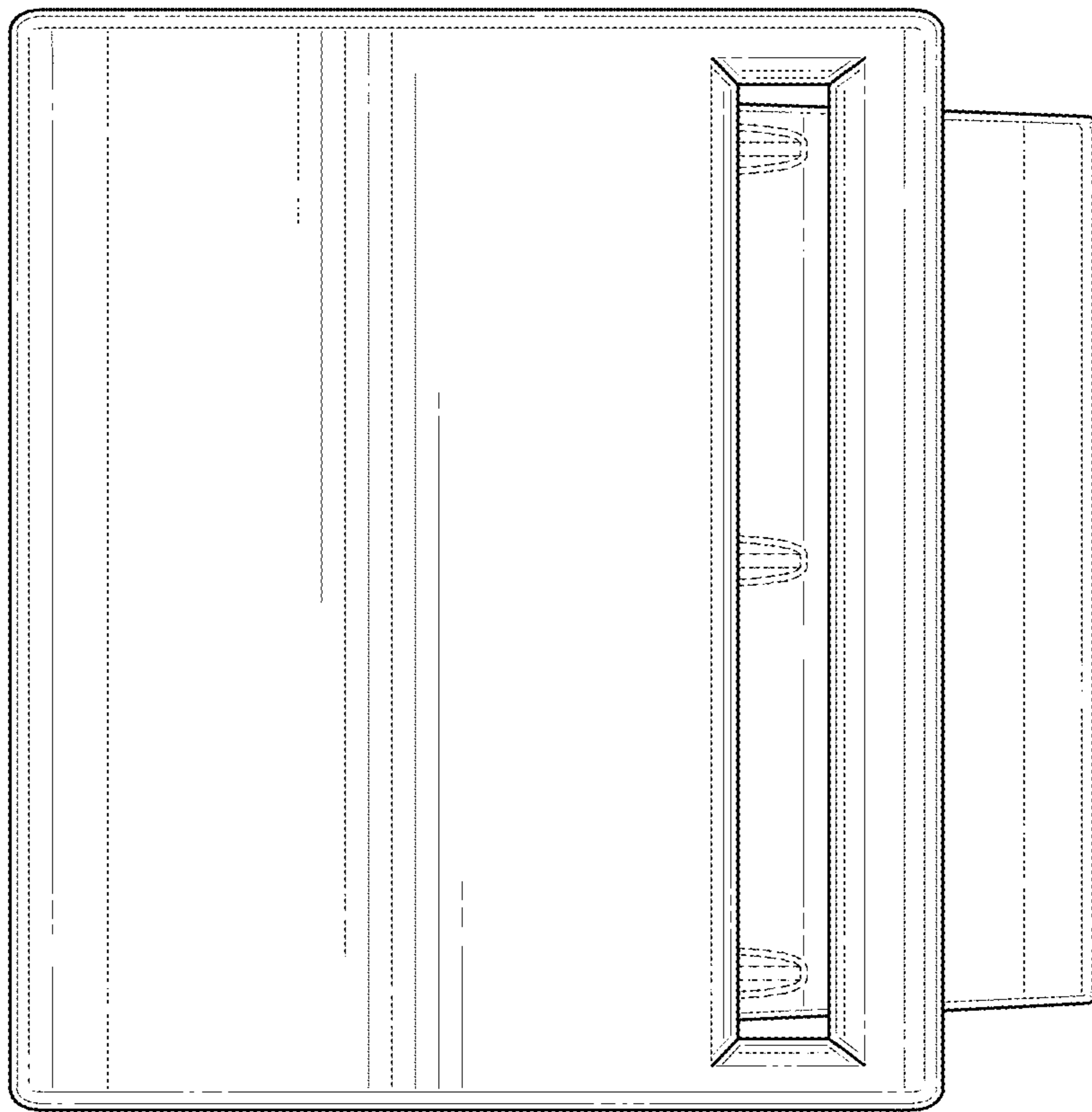
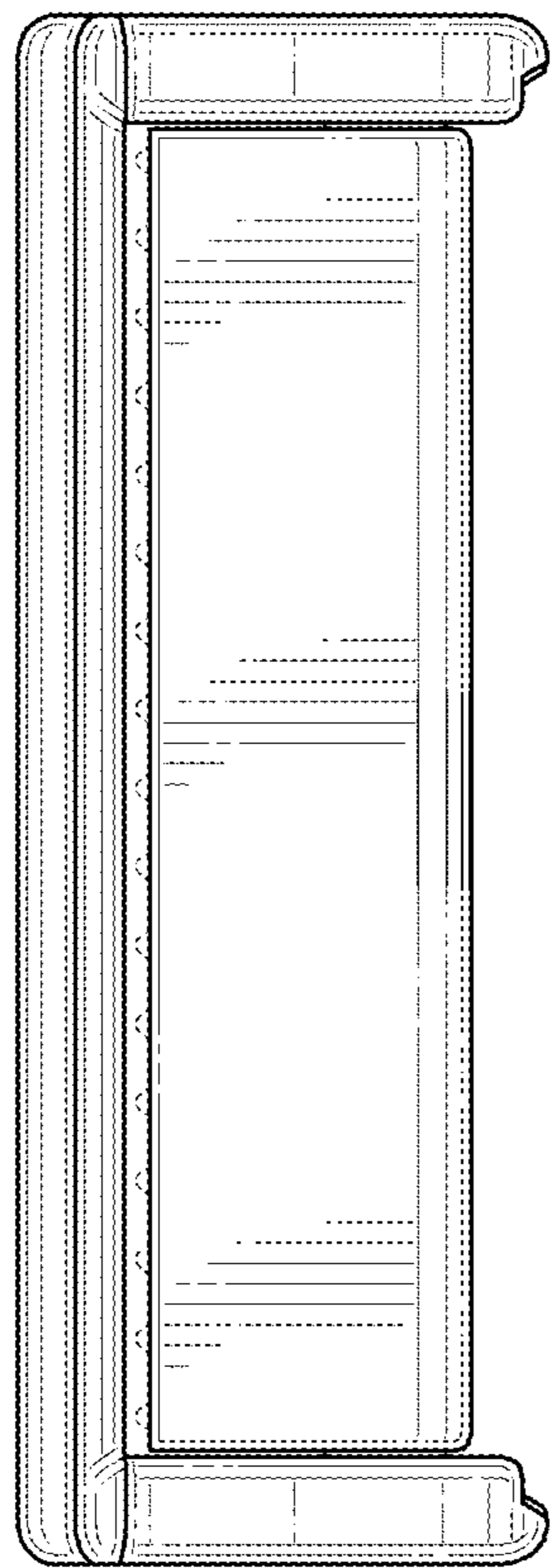
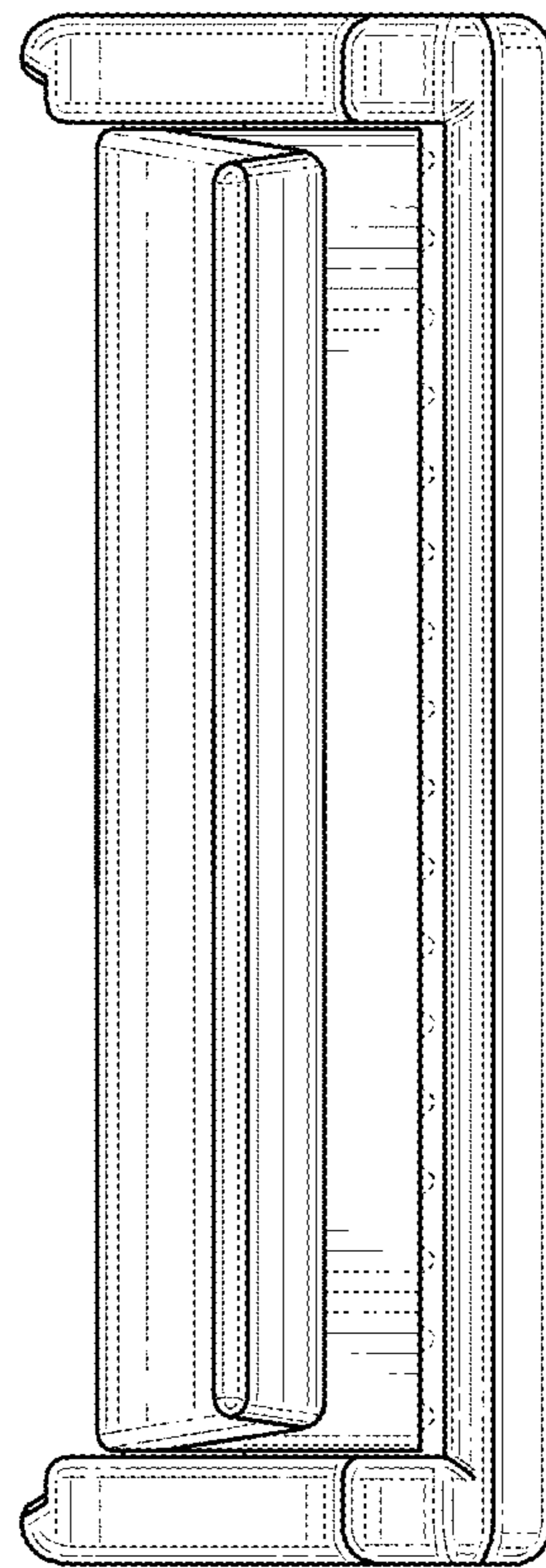

FIG. 3



*FIG. 4*



*FIG. 5*

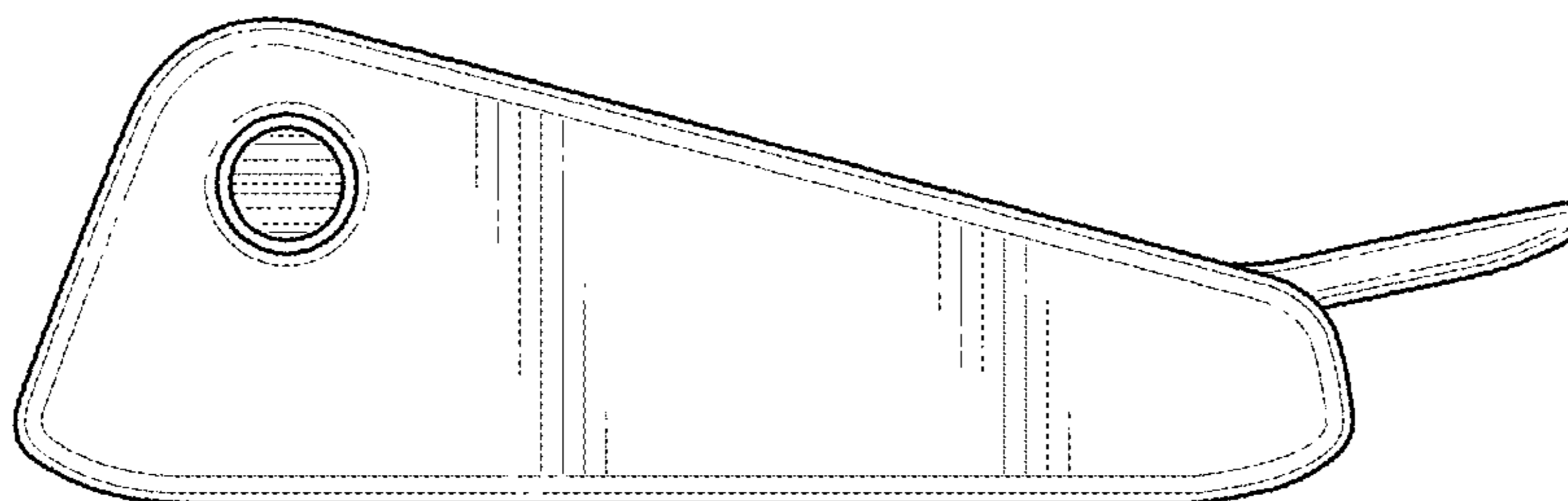

*FIG. 6*

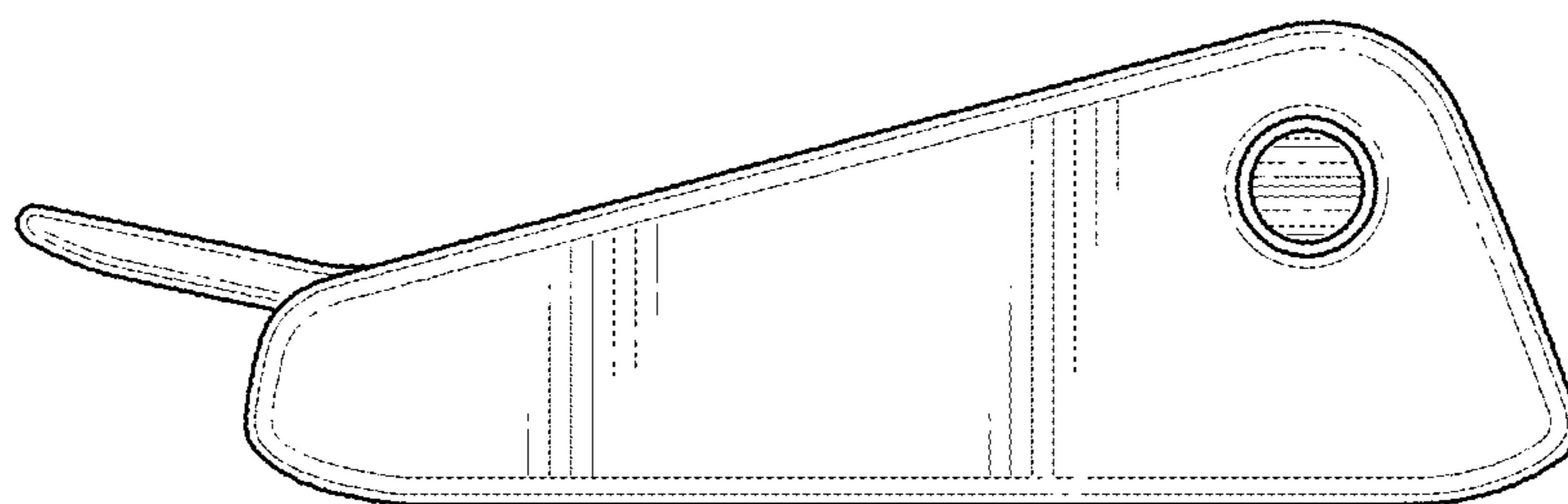

*FIG. 7*