



US00D934080S

(12) **United States Design Patent**  
**Cottam**

(10) **Patent No.:** **US D934,080 S**

(45) **Date of Patent:** **\*\* Oct. 26, 2021**

(54) **WHISKEY DECANTER**

(71) Applicant: **M&M Horizon Pty Ltd.**, Redwood Park (AU)

(72) Inventor: **Michael E Cottam**, Redwood Park (AU)

(\*\*) Term: **15 Years**

(21) Appl. No.: **29/686,597**

(22) Filed: **Apr. 5, 2019**

(51) **LOC (13) Cl.** ..... **07-01**

(52) **U.S. Cl.**  
USPC ..... **D9/544**; D9/568; D9/439

(58) **Field of Classification Search**  
USPC ..... D7/300, 507, 509–511, 514–516, 528, D7/532, 533, 537, 538, 608, 619.1, 628, D7/321; D9/434–436, 439–441, D9/500–504, 520, 530, 544, 551, 554, D9/560, 564–566, 572–575, 600, D9/655–664, 772  
CPC ..... A47G 19/2288; A47G 19/2266; A47G 19/2211; A47G 19/22; A47G 19/2272; B65B 7/3821; B65B 7/2828; B65D 39/06; B65D 39/02; B65D 39/0058; B65D 39/14; B65D 39/0047; B65D 67/00; B65D 2203/00; B65D 77/00

See application file for complete search history.

(56) **References Cited**

**U.S. PATENT DOCUMENTS**

D88,360 S *	11/1932	Marble	.....	D9/664
D92,078 S *	4/1934	Guerlain	.....	D9/544
D167,085 S *	6/1952	Kaufer	.....	D9/520
D172,869 S *	8/1954	Du Pree	.....	D7/303
D194,810 S *	3/1963	Du Pree	.....	D7/300
D324,822 S *	3/1992	Brabeck	.....	D7/605
D356,952 S *	4/1995	Daucourt	.....	D9/545
D632,185 S *	2/2011	Glass	.....	D9/667

D636,677 S *	4/2011	Diez	.....	D9/500
D730,191 S *	5/2015	Hardy	.....	D9/529
D833,824 S *	11/2018	Sanchez Garcia	.....	D7/523

(Continued)

**FOREIGN PATENT DOCUMENTS**

CN	DN-304101583	*	4/2017
GB	2011150	*	11/1990
JP	D1218613	*	9/2004

**OTHER PUBLICATIONS**

EBay, "Vintage Amber Square Diamond Glss Bottle," Jun. 19, 2014, Worthpoint.com, www.worthpoint.com/worthopedia/vintage-amber-square-diamond-glass-534976205 (Year: 2014).\*

(Continued)

*Primary Examiner* — Shannon W Morgan

*Assistant Examiner* — Arva P Adams

(74) *Attorney, Agent, or Firm* — Eric Karich; Karich & Associates

(57) **CLAIM**

The ornamental design for a whiskey decanter, as shown and described.

**DESCRIPTION**

FIG. 1 is a perspective view of a whiskey decanter, showing my new design;

FIG. 2 is a front elevational view thereof;

FIG. 3 is a rear elevational view thereof;

FIG. 4 is a left side elevational view thereof

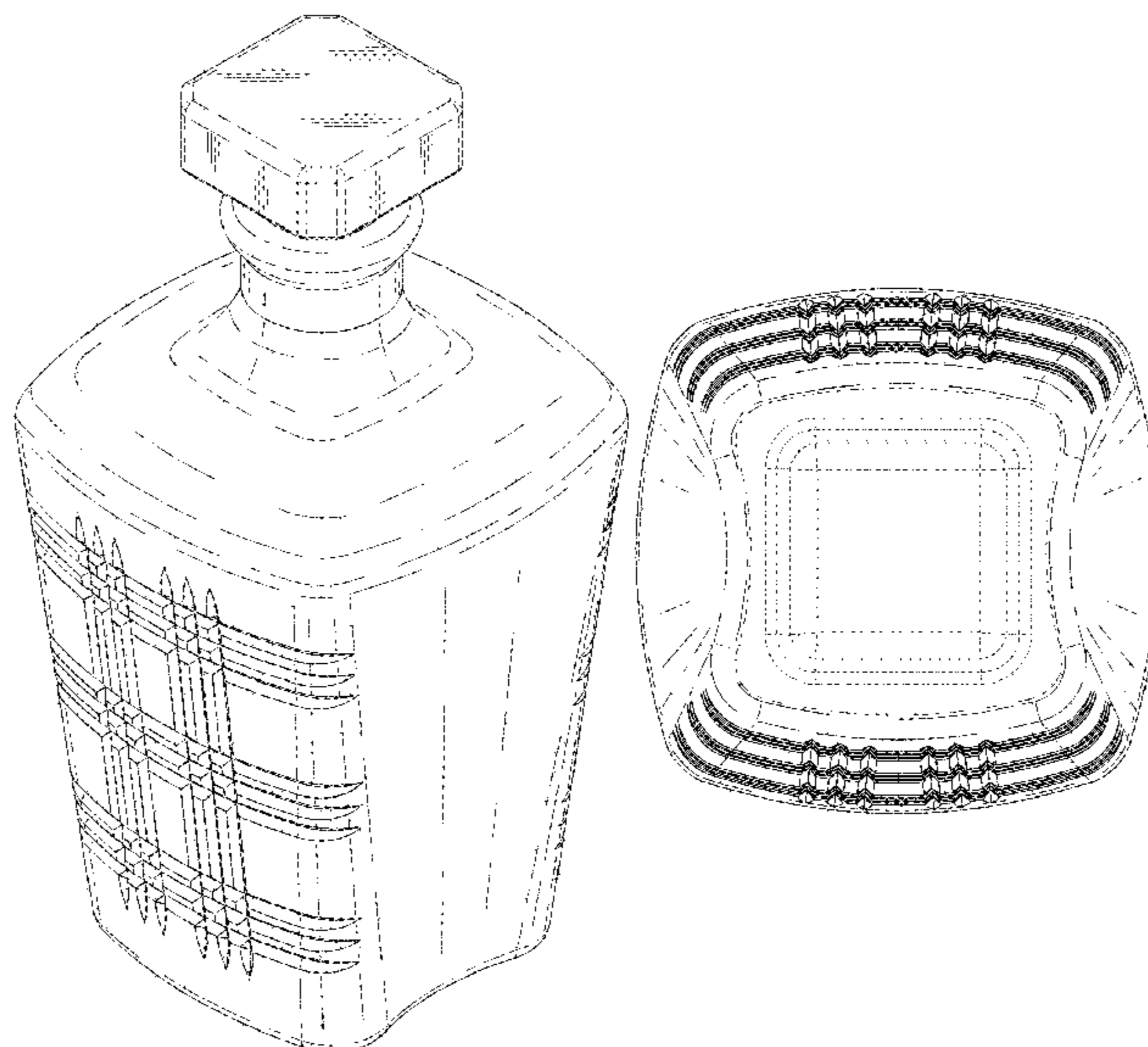
FIG. 5 is a right side elevational view thereof;

FIG. 6 is a top plan view thereof; and,

FIG. 7 is a bottom plan view thereof.

The even broken line showing of the bottom of the whiskey decanter is for the purpose of illustrating portions of the whiskey decanter that form no part of the claimed design. The dot-dash broken lines show a boundary of the claimed design and form no part of the claimed design.

**1 Claim, 7 Drawing Sheets**



(56)

**References Cited**

U.S. PATENT DOCUMENTS

D891,185 S \* 7/2020 Cottam ..... D7/530  
D894,007 S \* 8/2020 Eble ..... D9/563

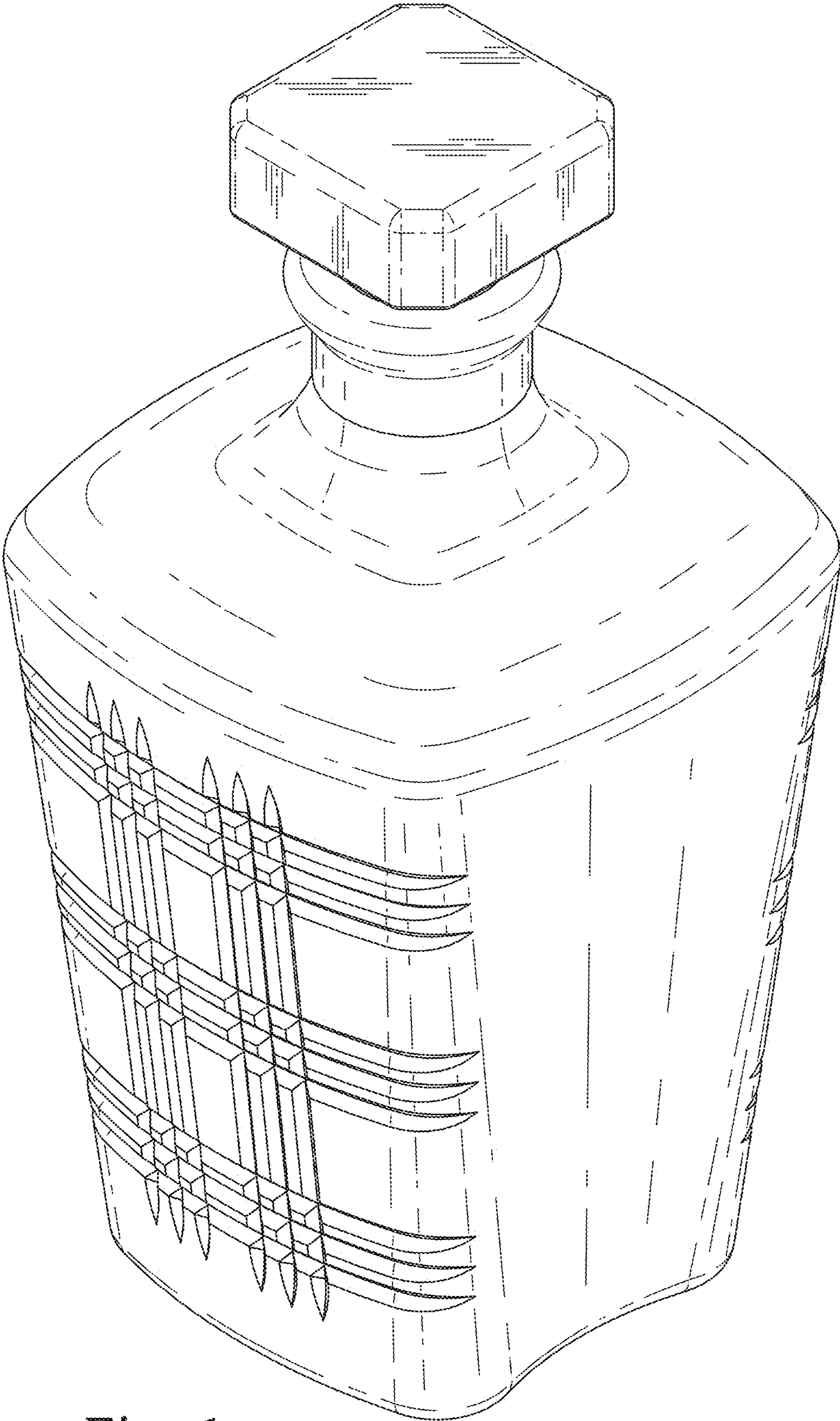
OTHER PUBLICATIONS

Ebay, "Welsh Royal Lead Crystal Decanter," Jun. 23, 2014, Worthpoint.com, [www.worthpoint.com/worthopedia/welsh-royal-lead-crystal-decanter-535560255](http://www.worthpoint.com/worthopedia/welsh-royal-lead-crystal-decanter-535560255) (Year: 2014).\*

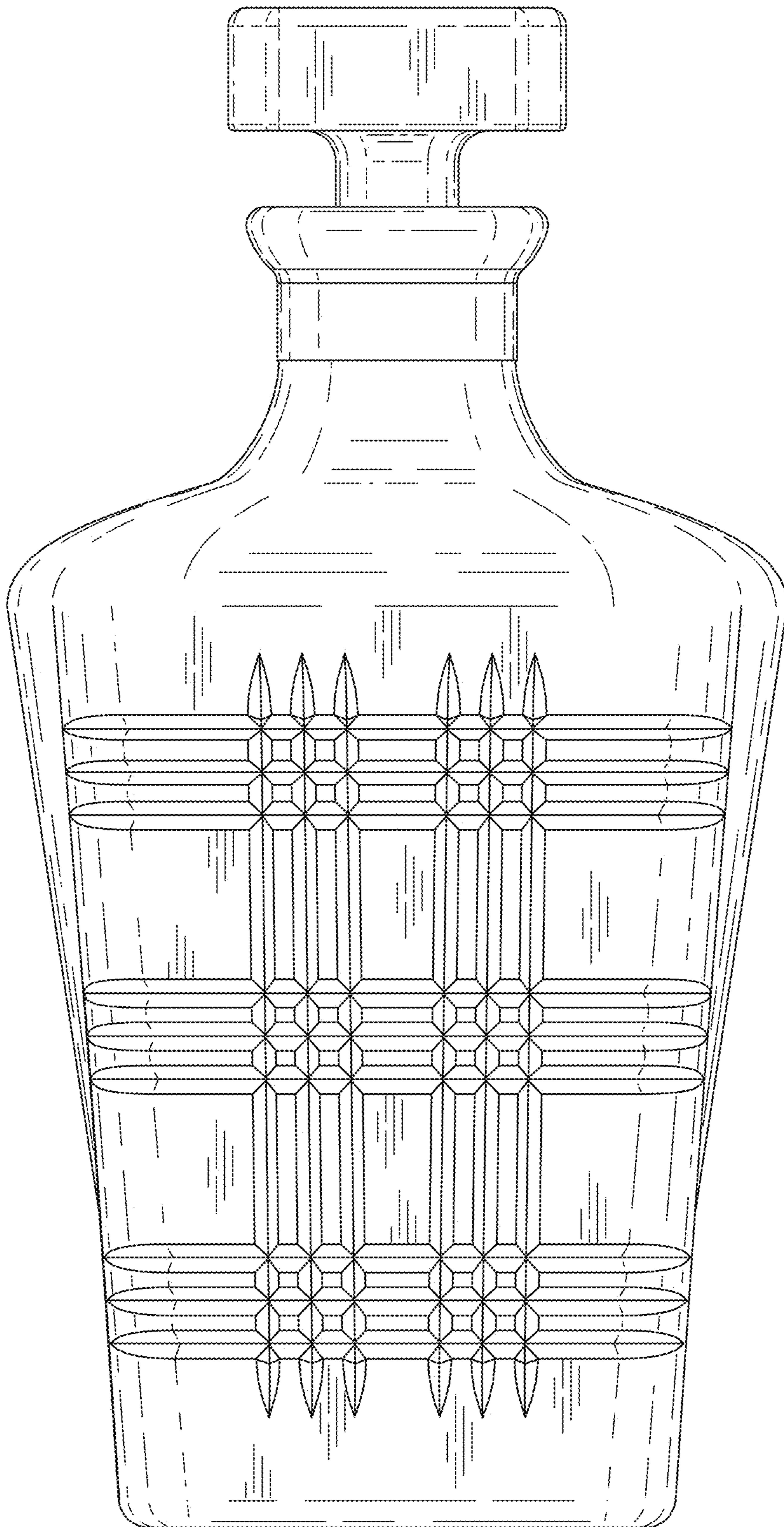
Ebay, "Atlantis Helsinki Whiskey Decanter," Oct. 18, 2015, Worthpoint.com, [www.worthpoint.com/worthopedia/atlantis-helsinki-whiskey-decanter-1791963430](http://www.worthpoint.com/worthopedia/atlantis-helsinki-whiskey-decanter-1791963430) (Year: 2015).\*

Sporran, "Whisky in Decanter and Crystal Glass stock photo," Feb. 17, 2016, iStockPhoto.com, [www.istockphoto.com/photo/whisky-in-decanter-and-crystal-glass-gm509100698-85593269](http://www.istockphoto.com/photo/whisky-in-decanter-and-crystal-glass-gm509100698-85593269) (Year: 2016).\*

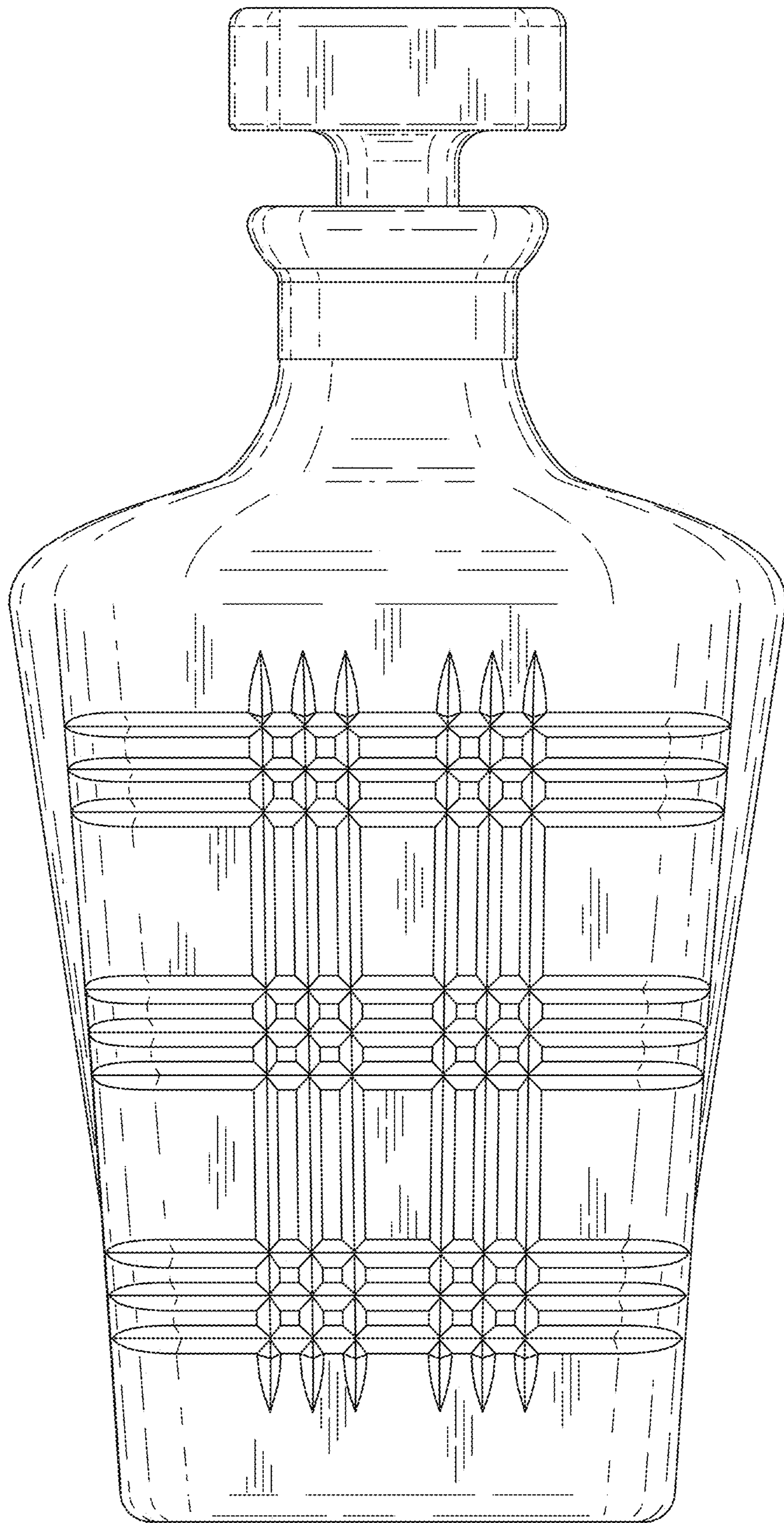
\* cited by examiner



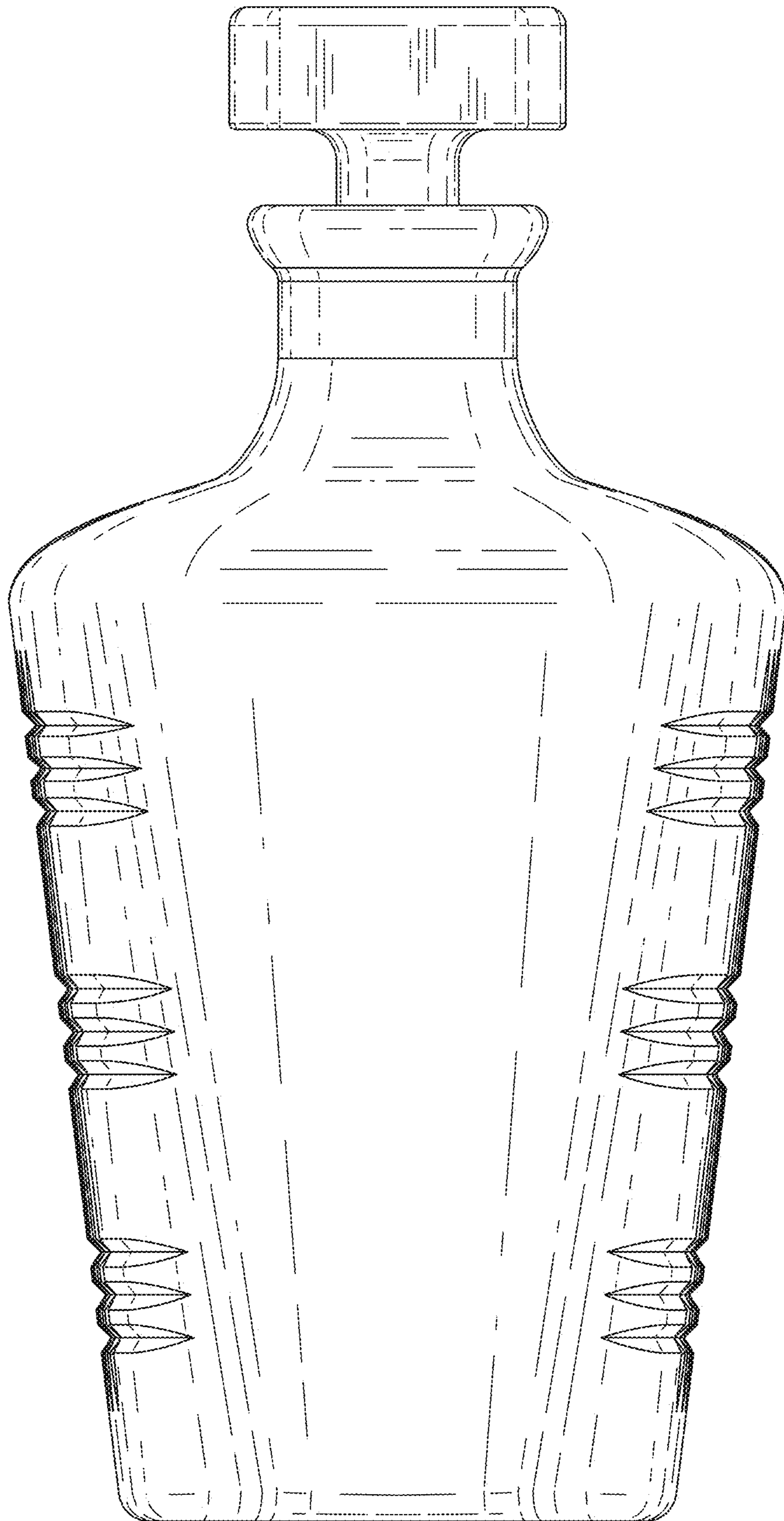
*Fig. 1*



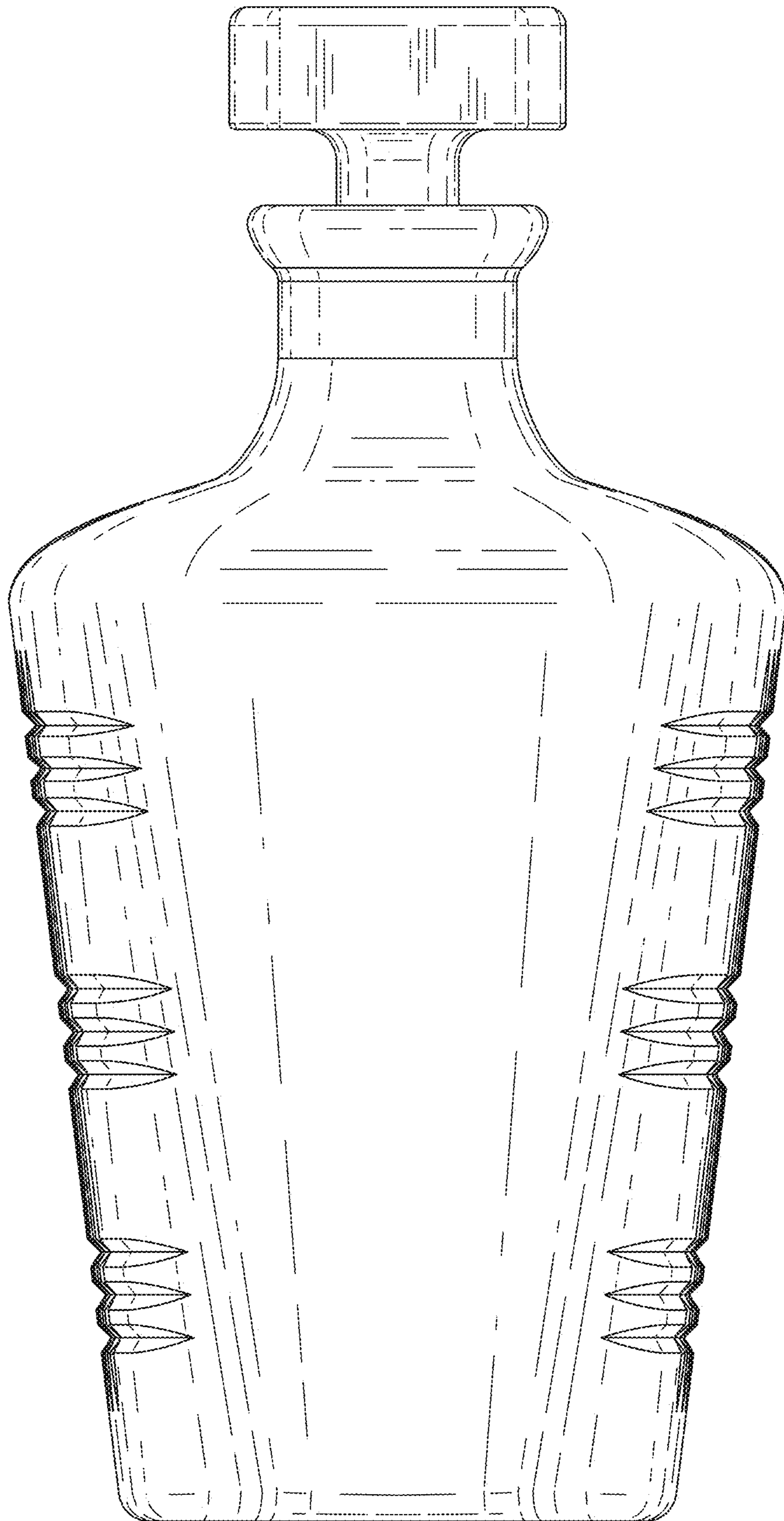
*Fig. 2*



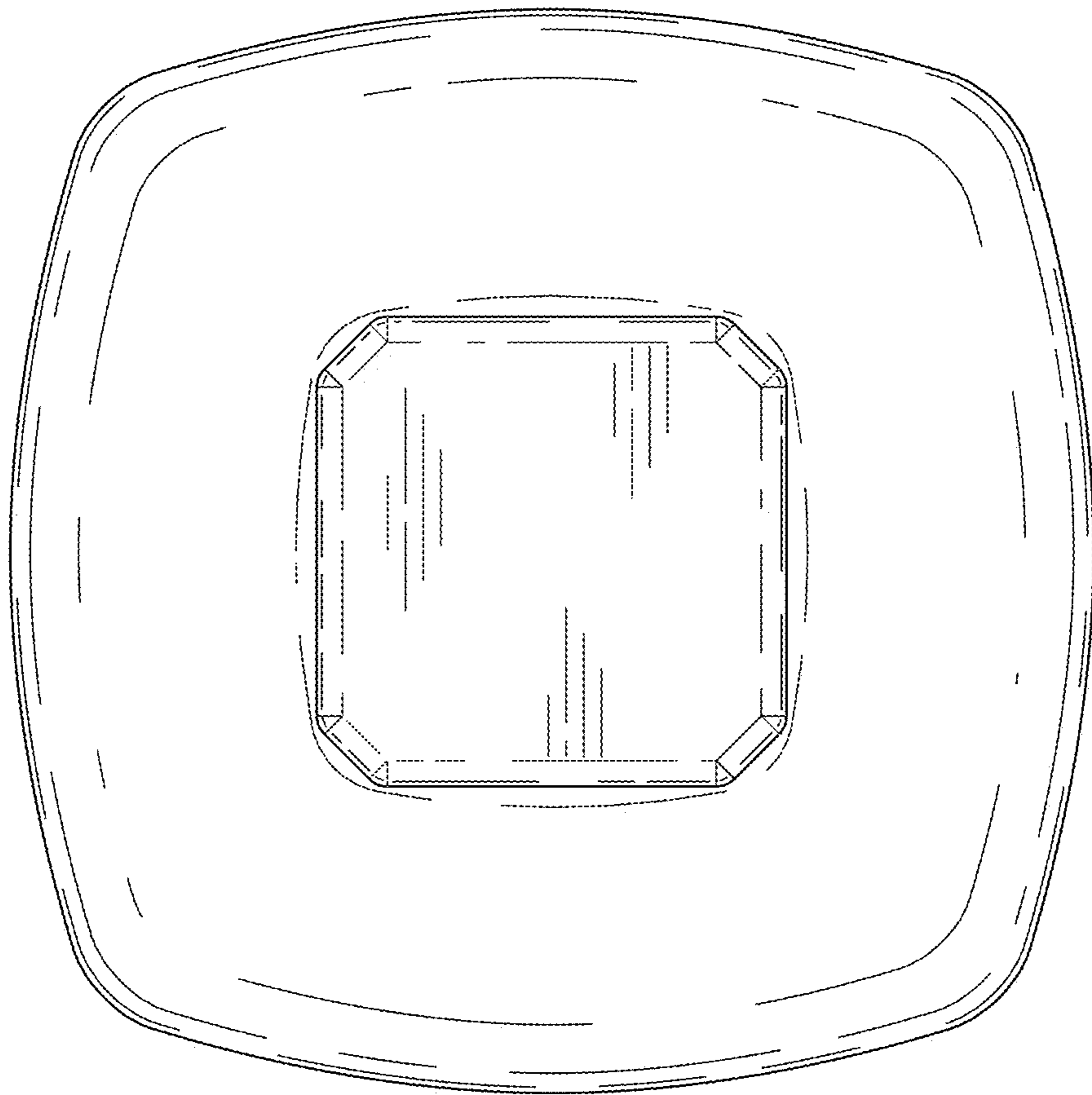
*Fig. 3*



*Fig. 4*

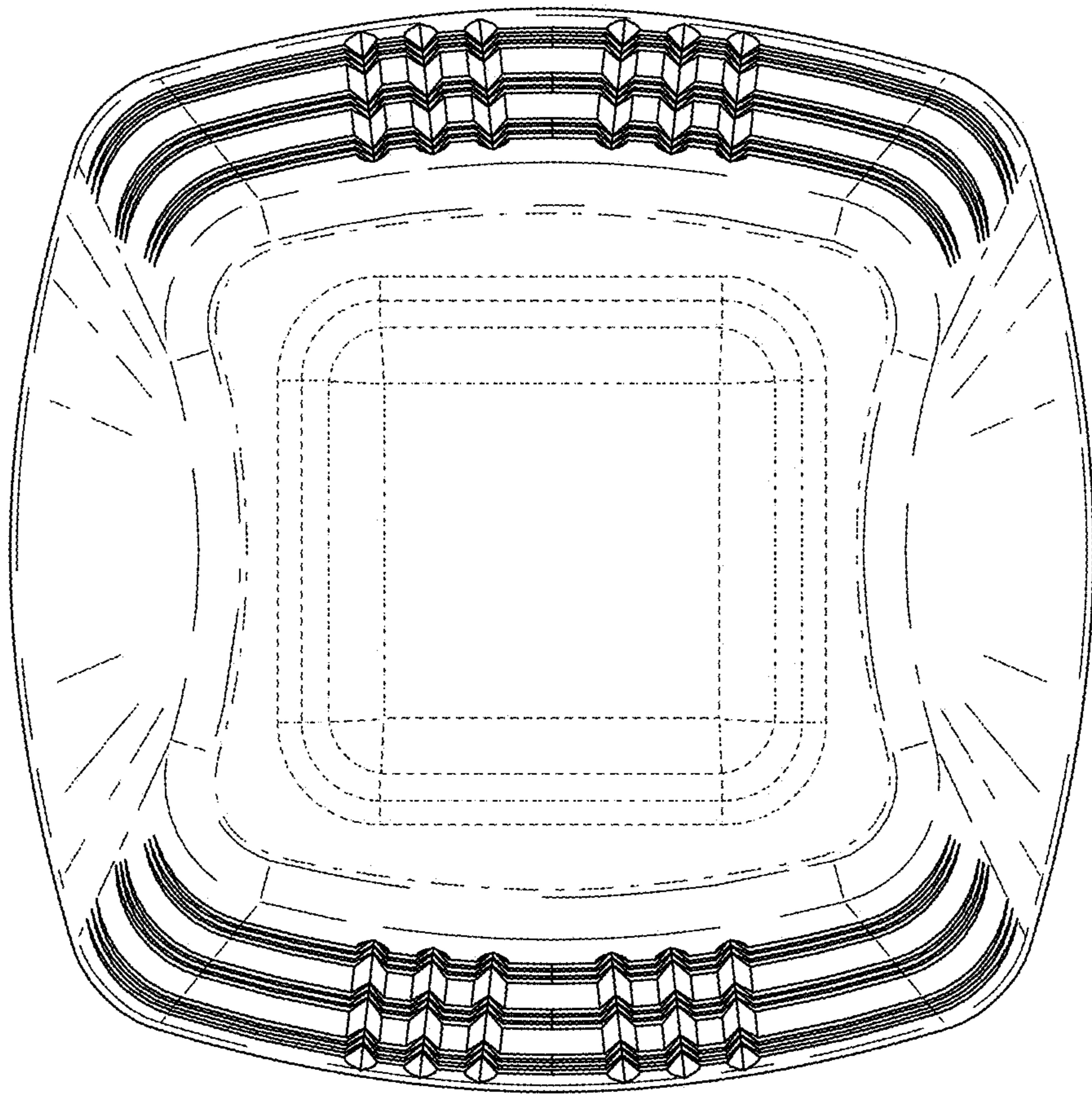


*Fig. 5*



*Fig. 6*





*Fig. 7*