



US00D934057S

(12) **United States Design Patent**
Morisaki

(10) **Patent No.:** **US D934,057 S**

(45) **Date of Patent:** **** Oct. 26, 2021**

(54) **MEDICAL PAD FOR ULTRASONICALLY ACTIVATED DEVICE**

(71) Applicant: **OLYMPUS CORPORATION**,
Hachioji (JP)

(72) Inventor: **Kazuhiro Morisaki**, Yokohama (JP)

(73) Assignee: **OLYMPUS CORPORATION**, Tokyo
(JP)

(**) Term: **15 Years**

(21) Appl. No.: **29/664,768**

(22) Filed: **Sep. 27, 2018**

(30) **Foreign Application Priority Data**

May 23, 2018 (JP) 2018-011288

(51) **LOC (13) Cl.** **08-05**

(52) **U.S. Cl.**
USPC **D8/354**

(58) **Field of Classification Search**

USPC D24/127; D8/354, 373, 374, 376, 377,
D8/349, 364, 380, 382; D25/35, 102,
D25/119-125, 164; 248/682, 205.1;
73/493, 627, 628, 632, 649; 310/322,
310/334-337; 367/140, 188; 293/117

CPC A61B 17/320092; A61B 17/282; A61B
17/295; A61B 17/32; A61B 2017/320072

See application file for complete search history.

(56) **References Cited**

U.S. PATENT DOCUMENTS

D42,538 S * 5/1912 Jalliffier D25/119
D372,939 S * 8/1996 Callas D20/43

D382,653 S * 8/1997 Colitto D25/122
D388,181 S * 12/1997 Payton D25/121
D457,052 S * 5/2002 Snyder D8/349
D518,900 S * 4/2006 Barnett D25/119
D547,883 S * 7/2007 Aughton D25/119
D741,689 S * 10/2015 Metzler D8/349
D795,454 S * 8/2017 Curtin D25/119
D818,194 S * 5/2018 Trzesniowski D26/138
D834,729 S * 11/2018 Lee D25/119
D844,854 S * 4/2019 Lee D25/61
D874,025 S * 1/2020 Kittur D25/119

* cited by examiner

Primary Examiner — Nathan M Johnston

(74) *Attorney, Agent, or Firm* — Oliff PLC

(57) **CLAIM**

The ornamental design for a medical pad for ultrasonically activated device, as shown and described.

DESCRIPTION

FIG. 1 is a front, top, left-side perspective view of the medical pad for ultrasonically activated device;
FIG. 2 is a rear, bottom, right-side perspective view thereof;
FIG. 3 is a front elevational view thereof;
FIG. 4 is a left-side elevational view thereof;
FIG. 5 is a right-side elevational view thereof;
FIG. 6 is a top plan view thereof;
FIG. 7 is a bottom plan view thereof; and,
FIG. 8 is a reference view showing the pad in a state attached to the device.

The broken lines depict environmental subject matter only, and thus form no part of the claimed design.

1 Claim, 5 Drawing Sheets

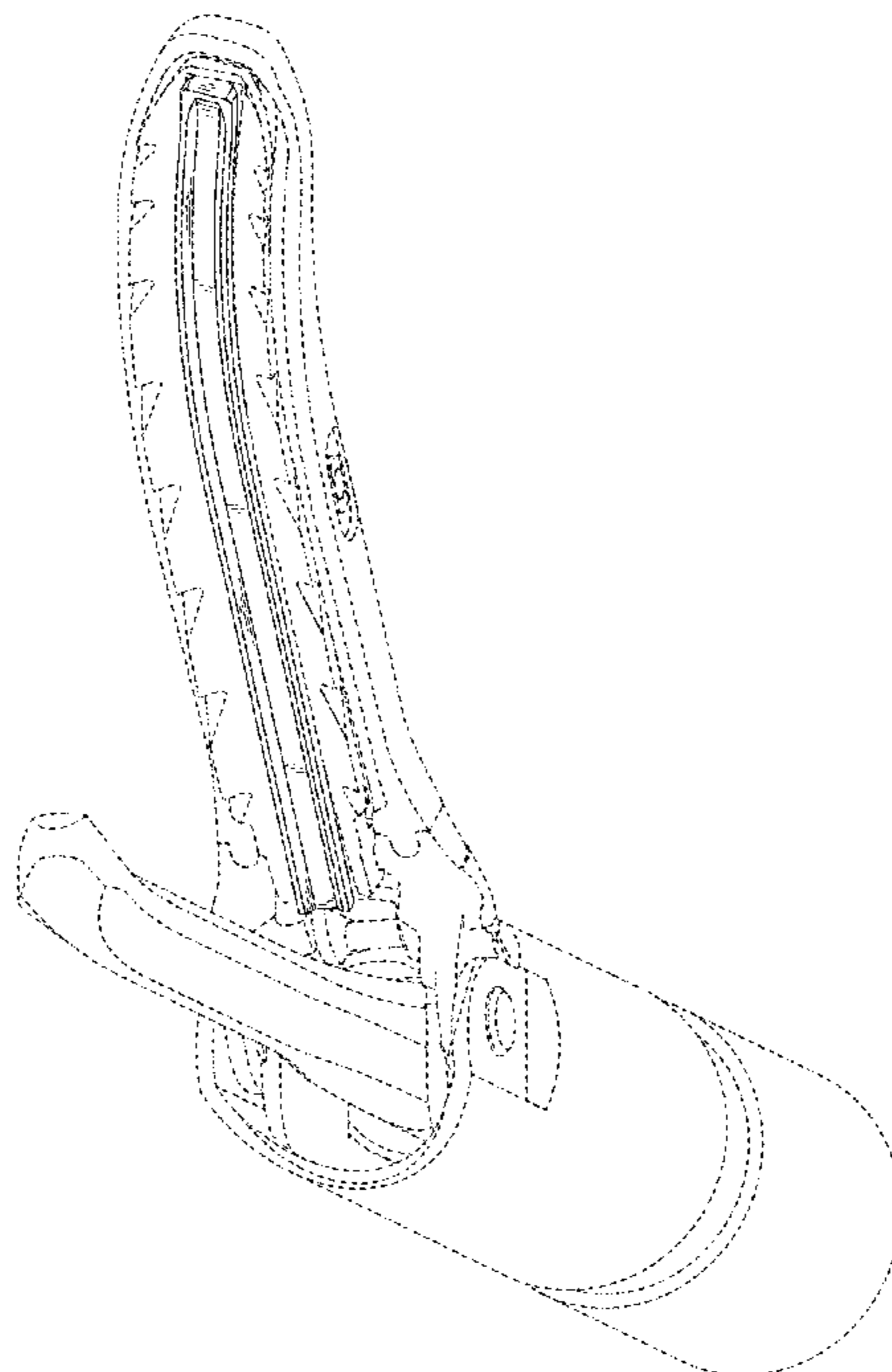

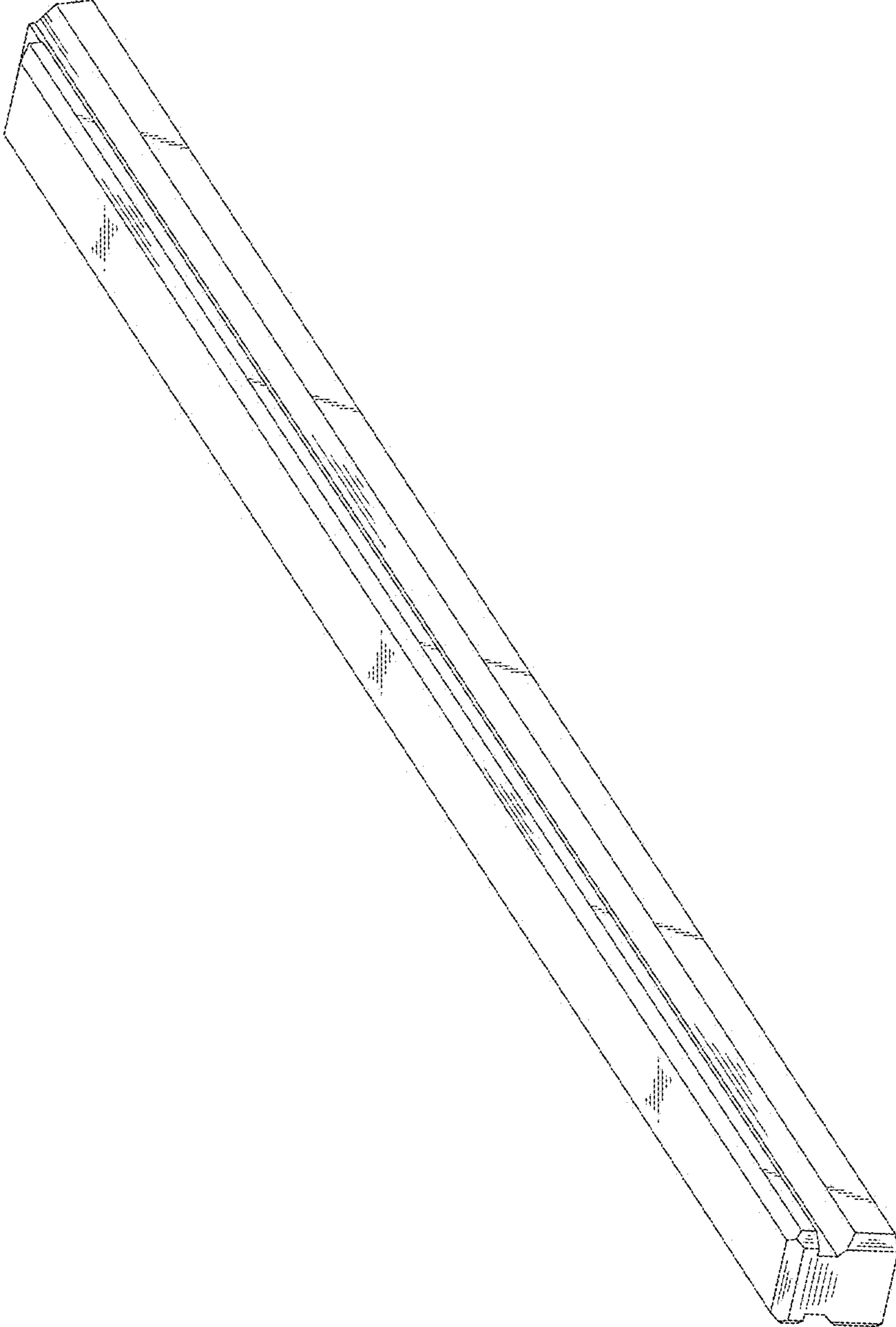

FIG. 1

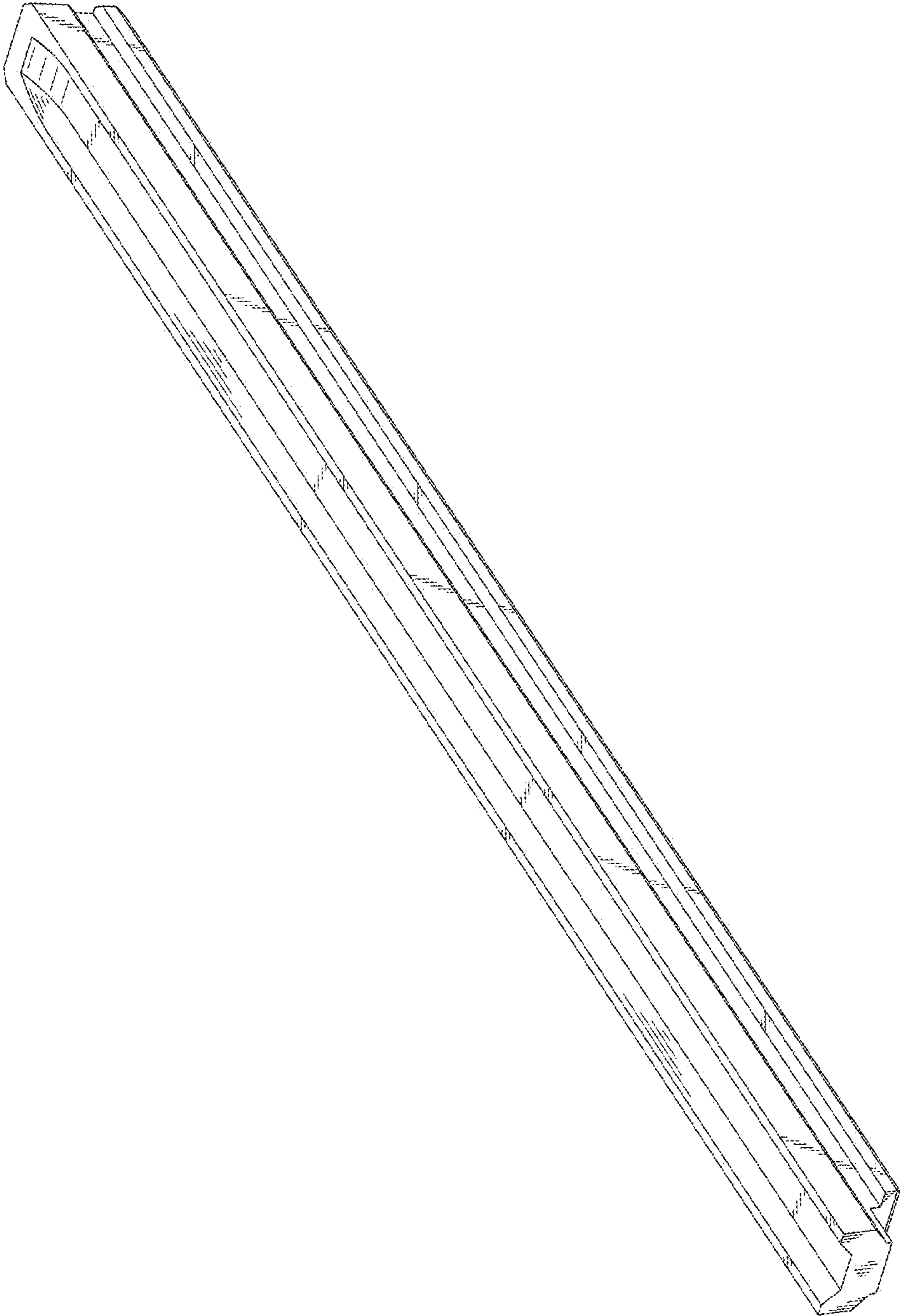

FIG. 2

FIG. 3

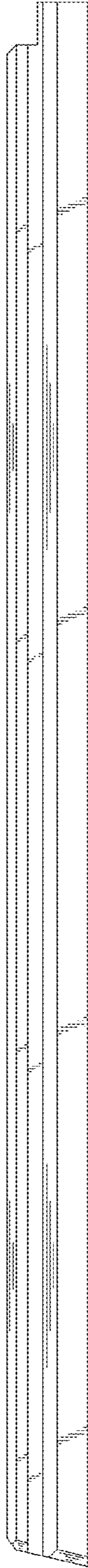

FIG. 4

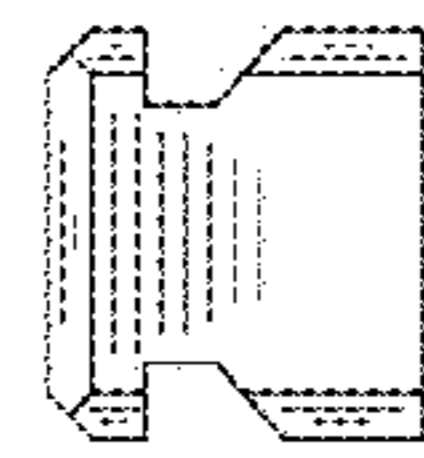

FIG. 5

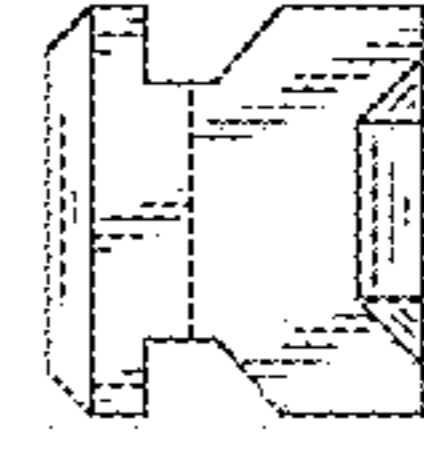

FIG. 6

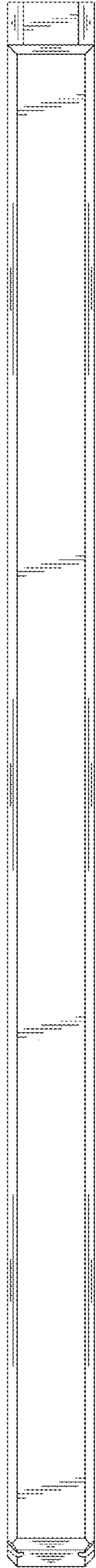

FIG. 7

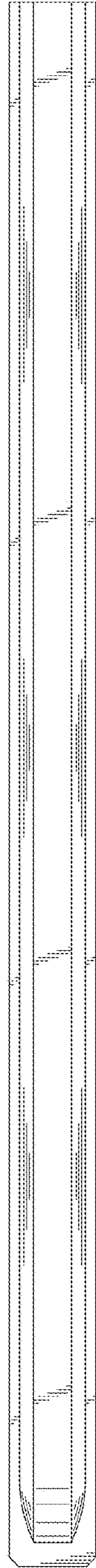

FIG. 8

