



US00D933995S

(12) **United States Design Patent**  
**Lin**

(10) **Patent No.:** **US D933,995 S**

(45) **Date of Patent:** **\*\* Oct. 26, 2021**

(54) **FILM CUTTING MACHINE**

(71) Applicant: **ShenZhen ZhenDong Precision Metal CO., Ltd.**, Guangdong (CN)

(72) Inventor: **Wanliang Lin**, Guangdong (CN)

(73) Assignee: **ShenZhen ZhenDong Precision Metal CO., Ltd.**, Shenzhen (CN)

(\*\*) Term: **15 Years**

(21) Appl. No.: **29/702,061**

(22) Filed: **Aug. 16, 2019**

(30) **Foreign Application Priority Data**

May 23, 2019 (CN) ..... 201930257701.7

(51) **LOC (13) Cl.** ..... **06-06**

(52) **U.S. Cl.**  
USPC ..... **D6/518**

(58) **Field of Classification Search**  
USPC ..... D6/518, 520  
CPC ..... A47K 10/38; A47K 10/3827;  
Y10T 225/245; Y10T 225/254; B26D  
1/02; B65D 83/0841; B65D 83/0882;  
B65H 35/0006; B65H 35/002; Y10S  
206/824

See application file for complete search history.

(56) **References Cited**

**U.S. PATENT DOCUMENTS**

1,676,854 A \* 7/1928 Casterline ..... A47K 10/38  
225/44  
D155,271 S \* 9/1949 Collard et al. .... D6/520

D158,207 S \* 4/1950 Lench ..... D6/518  
D166,804 S \* 5/1952 DeGrace ..... D6/518  
3,893,609 A \* 7/1975 Jamois ..... B26D 1/02  
225/42  
D272,970 S \* 3/1984 Hasegawa ..... D6/518  
4,936,452 A \* 6/1990 Pauley ..... A47K 10/3827  
206/408  
5,275,321 A \* 1/1994 Manu ..... B65H 35/002  
206/407  
D357,377 S \* 4/1995 Manu ..... D6/518  
D441,577 S \* 5/2001 Benedetti ..... D6/518  
D452,788 S \* 1/2002 Neiberger ..... D6/518  
D595,075 S \* 6/2009 Ramos Peon ..... D6/518  
8,714,428 B2 \* 5/2014 Mallard ..... B65D 83/0841  
225/58

\* cited by examiner

*Primary Examiner* — Nathaniel D. Buckner

(74) *Attorney, Agent, or Firm* — Wayne IP LLC

(57) **CLAIM**

The ornamental design for a film cutting machine, as shown and described.

**DESCRIPTION**

FIG. 1 is a top left perspective view of a film cutting machine showing my new design;  
FIG. 2 is a front elevation view thereof;  
FIG. 3 is a rear elevation view thereof;  
FIG. 4 is a top plan view thereof;  
FIG. 5 is a bottom plan view thereof;  
FIG. 6 is a left side elevation view thereof; and,  
FIG. 7 is a right side elevation view thereof.  
The broken lines in the figures depict portions of the article which form no part of the claimed design.

**1 Claim, 7 Drawing Sheets**

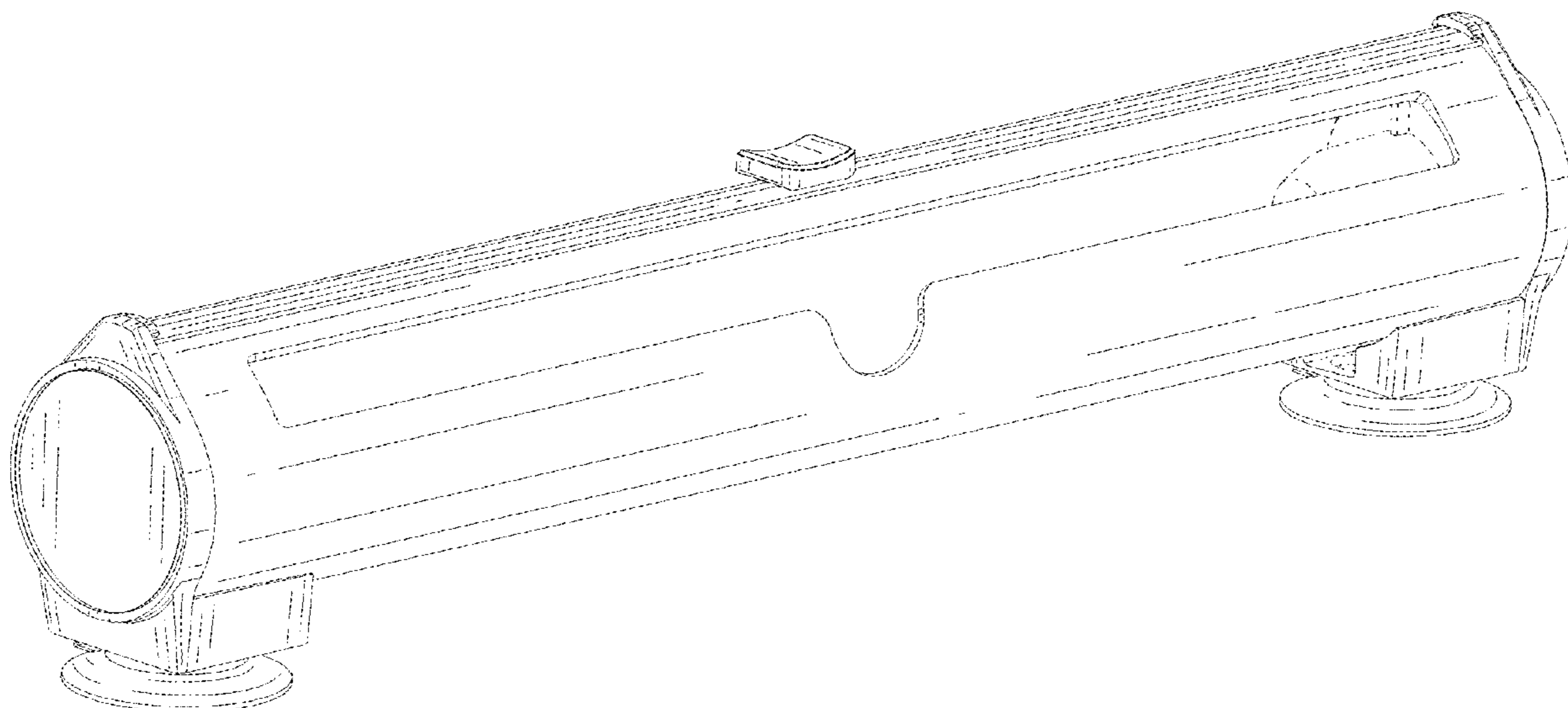

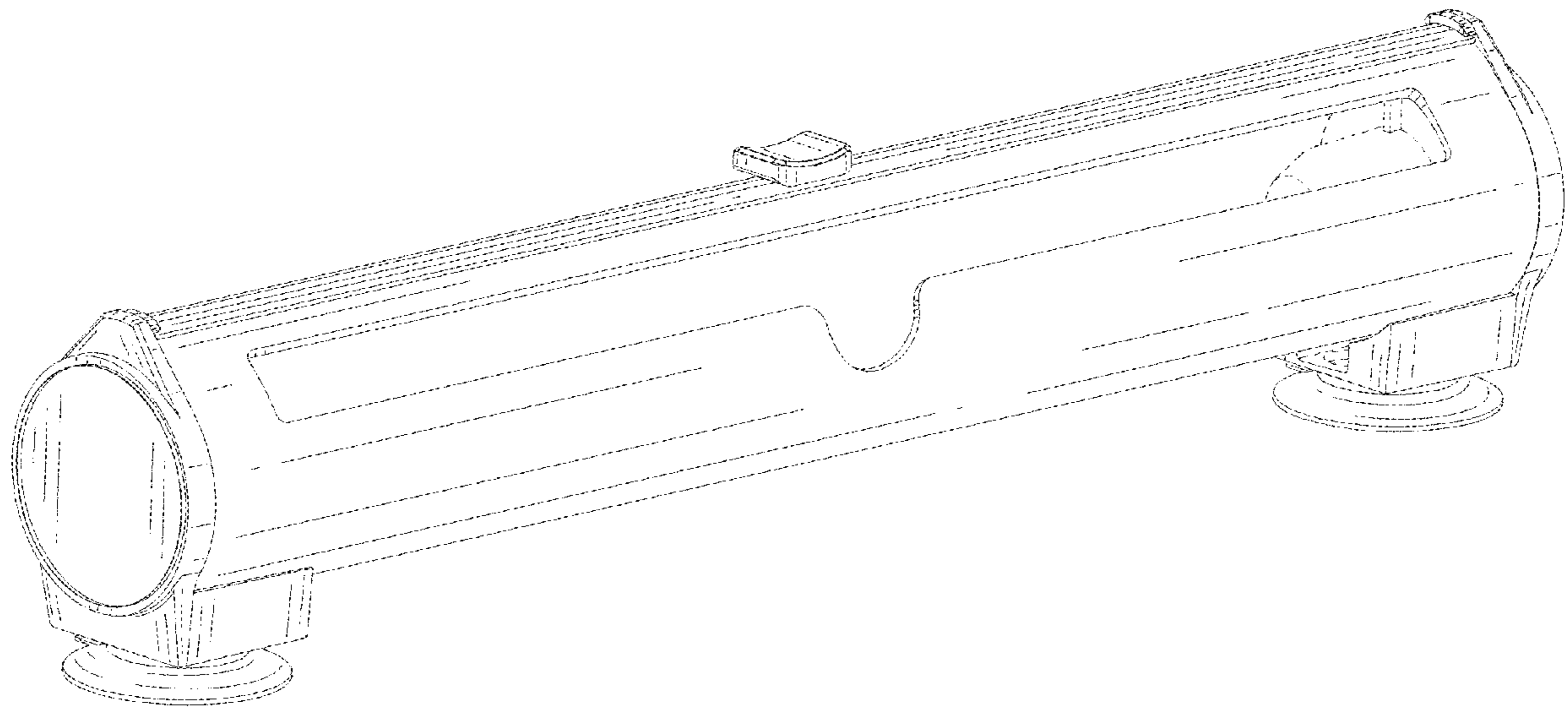

FIG. 1

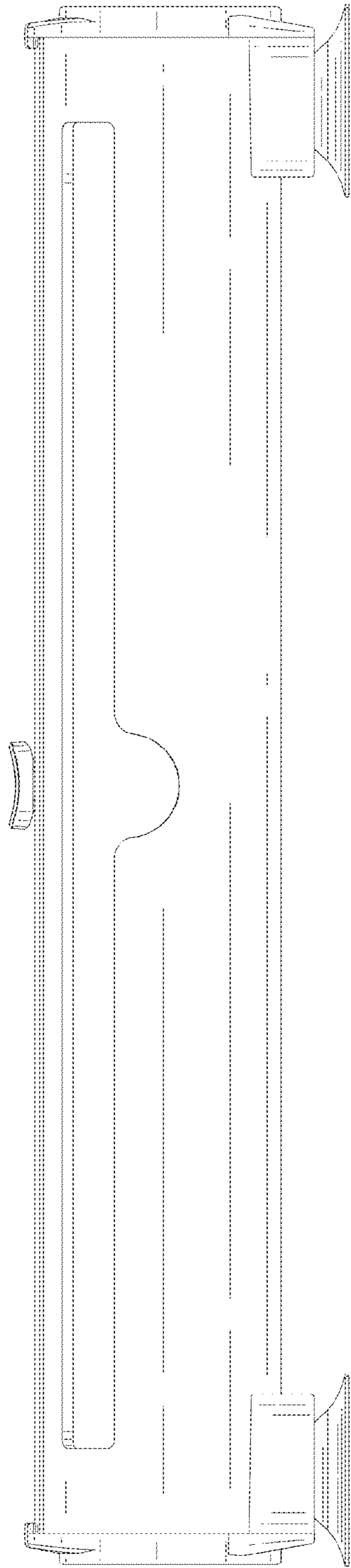

FIG. 2

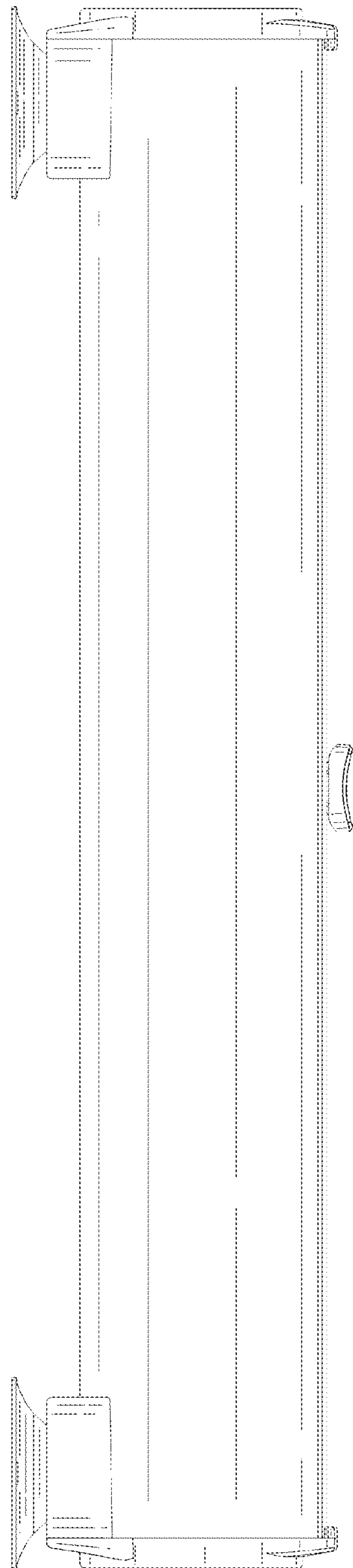

FIG. 3

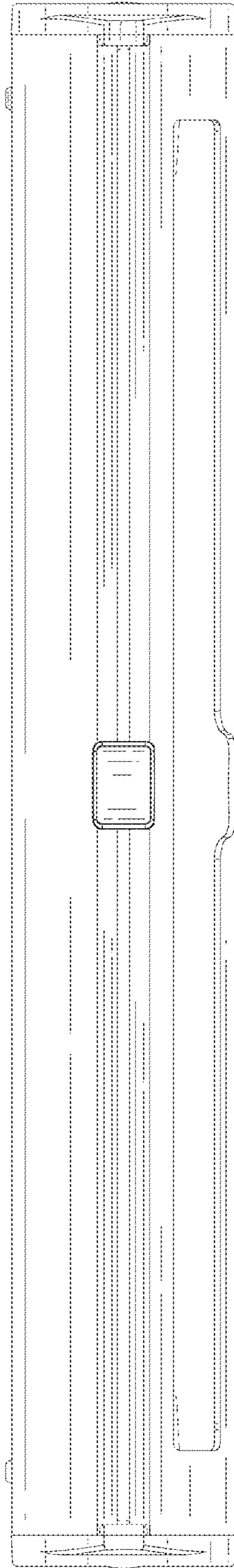

FIG. 4

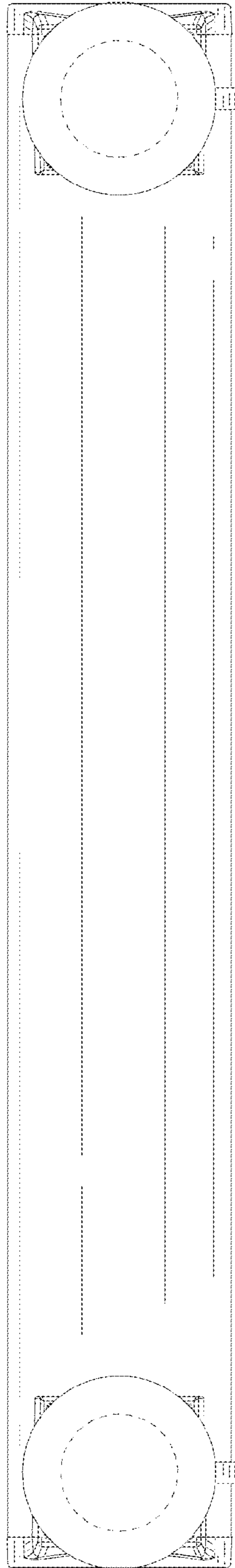

FIG. 5

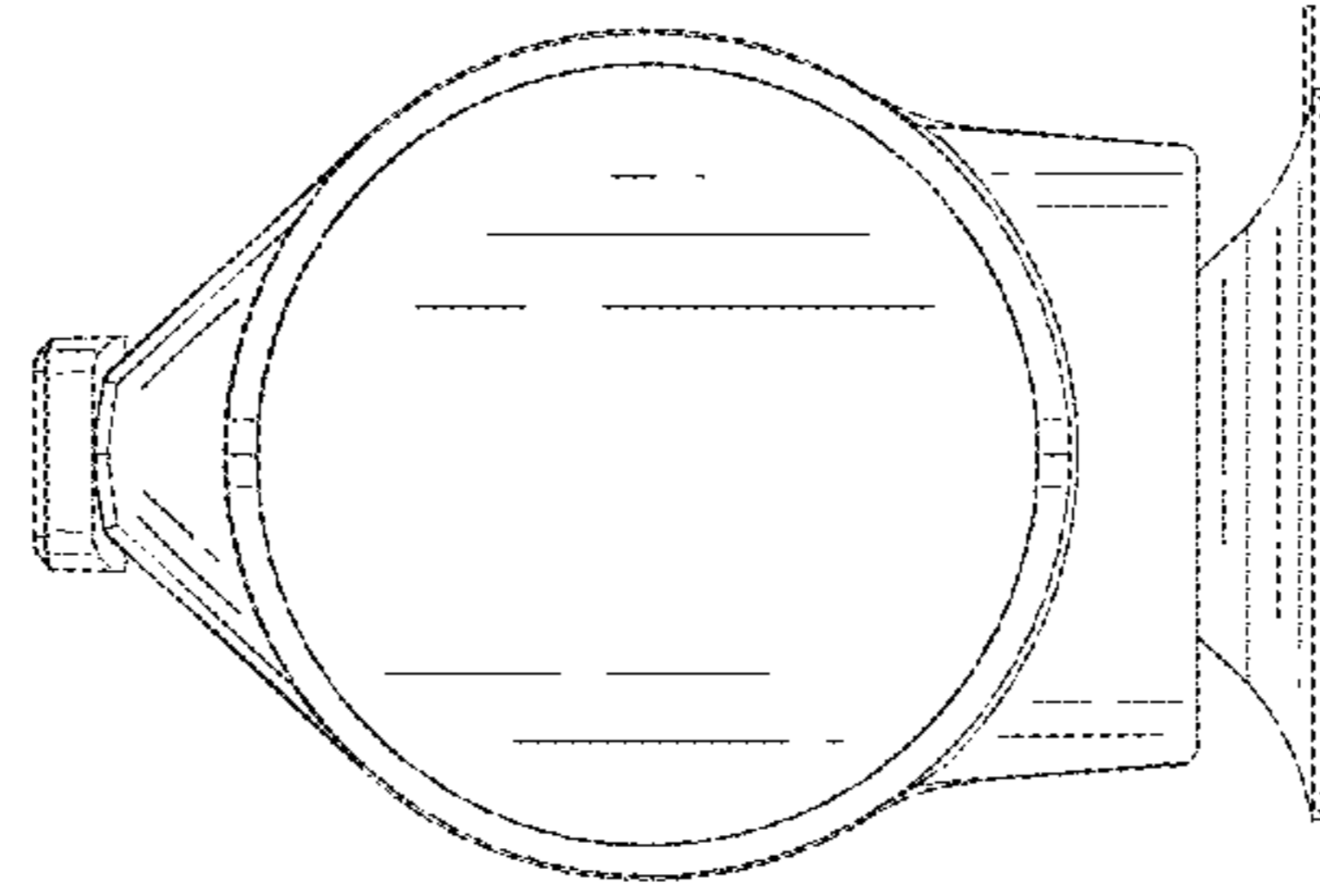

FIG. 6

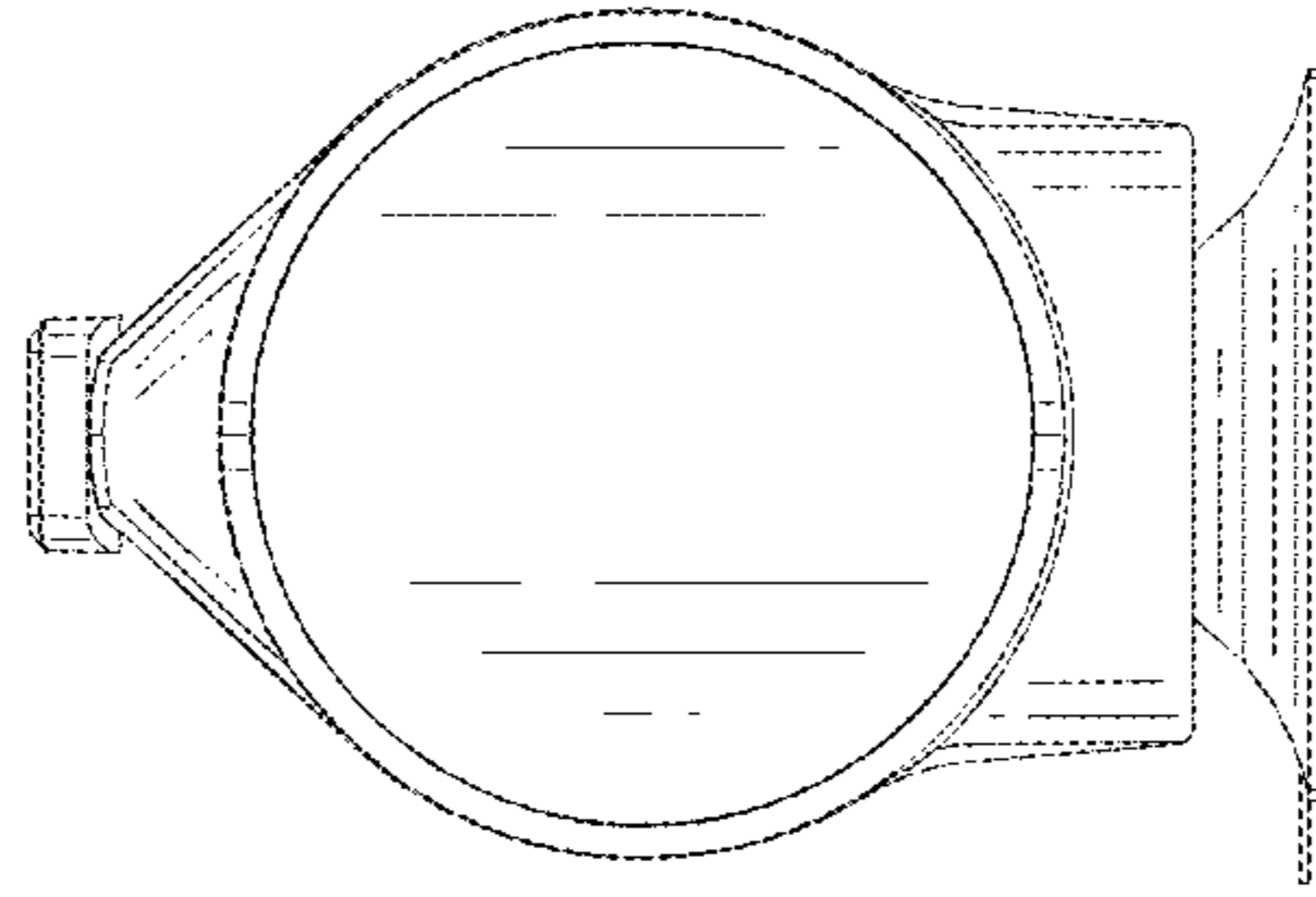

FIG. 7