



US00D933981S

(12) **United States Design Patent** (10) **Patent No.:** **US D933,981 S**
Smith (45) **Date of Patent:** **** Oct. 26, 2021**

(54) **PORTABLE CHAIR**

(71) Applicant: **Wornie Lynn Smith**, Columbus, GA (US)

(72) Inventor: **Wornie Lynn Smith**, Columbus, GA (US)

(**) Term: **15 Years**

(21) Appl. No.: **29/660,407**

(22) Filed: **Aug. 21, 2018**

(51) **LOC (13) Cl.** **06-01**

(52) **U.S. Cl.**

USPC **D6/362**

(58) **Field of Classification Search**

USPC D6/347, 362, 386

CPC A45F 3/24; A45F 3/22; A47B 5/00; A47C 1/02; A47C 1/032; A47C 1/14; A47C 1/03244; A47C 3/18; A47C 4/42; A47C 4/20; A47C 4/28; A47C 7/62; A47C 7/66; A47C 7/622; A47C 7/407; A47C 9/00; A47C 9/06; A47C 9/10; A47C 15/00; A47C 21/00; A61G 7/10; A01M 31/02; A01M 31/00; A01M 31/025; B60N 2/04; E04H 15/30; F41A 23/18; F41A 23/14; F41A 23/16; F41C 27/00; F42B 12/38; Y10S 135/901

See application file for complete search history.

(56) **References Cited**

U.S. PATENT DOCUMENTS

872,739 A 12/1907 McDaniel
1,181,508 A * 5/1916 Davis A45F 3/22
5/122

(Continued)

OTHER PUBLICATIONS

“Hammock Seat” Apr. 2, 2014, fanaticoutdoors.com, site visited Sep. 2, 2020 <<https://www.fanaticoutdoors.com/product/hammock-seat/#reviews>> (Year: 2014).*

Primary Examiner — Kevin K Rudzinski

Assistant Examiner — Paul D Bohannon

(74) *Attorney, Agent, or Firm* — Thomas|Horstemeyer, LLP

(57) **CLAIM**

The ornamental design for a portable seat, as shown and described.

DESCRIPTION

FIG. 1 is a front elevation view of a portable chair showing my new design as attached to a support in the form of a tree; FIG. 2 is a front side perspective view, the opposite side being a mirror image thereof;

FIG. 3 is a rear side perspective view;

FIG. 4 is a top view thereof;

FIG. 5 is a top view of the seat portion thereof, shown prior to attachment to a tree or other support at one end of the seat portion and prior to attachment to the support members thereof at the opposite end of the seat portion;

FIG. 6 is a side view of the support members of the portable seat, unattached to the seat, in a closed position shown with rectangular portions attached to the inner surfaces in alternate positions than what is shown in FIG. 4;

FIG. 7 is an enlarged end view of the support members of FIG. 6;

FIG. 8 is an enlarged end view of the support members of FIG. 6 but showing the end of the support members in an open position for supporting the seat as depicted in FIGS. 1-3;

FIG. 9 is a perpendicular enlarged end view of the support members of FIG. 7; and,

FIG. 10 is an end view of the support members of FIG. 6 of the chair.

The broken lines in the figures illustrate environment and form no part of the claimed design.

1 Claim, 5 Drawing Sheets

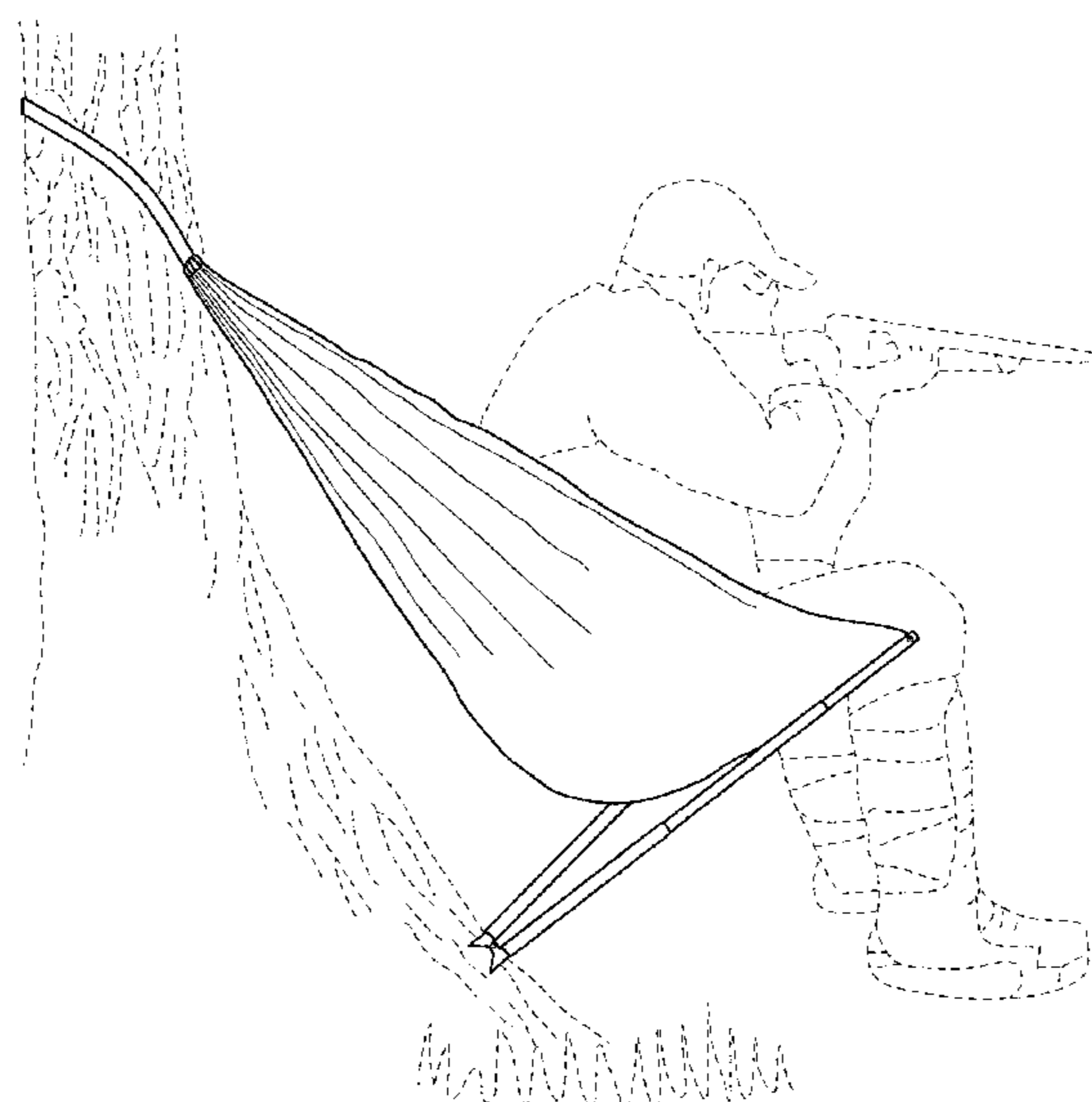

(56)

References Cited

U.S. PATENT DOCUMENTS

1,434,841 A * 11/1922 Pittoni A45F 3/24
5/130
2,722,968 A * 11/1955 Smith A01M 31/02
182/187
3,992,055 A * 11/1976 Shaw A01M 31/02
182/187
4,221,429 A * 9/1980 Wade A47C 7/66
297/277
4,394,045 A * 7/1983 Shaw A01M 31/02
297/118
4,602,698 A * 7/1986 Grant A01M 31/02
182/142
4,605,261 A * 8/1986 Lee A47C 4/286
297/16.1
4,705,143 A 11/1987 Ziemba
4,944,057 A * 7/1990 Shaw A61G 7/1023
224/159
5,083,324 A * 1/1992 Strong A47K 11/04
182/187
5,490,478 A * 2/1996 Cole A01K 1/03
119/28.5
6,328,131 B1 12/2001 Backus

6,418,577 B1 * 7/2002 Murphy A45F 3/24
5/120
7,258,401 B2 8/2007 Smith
D599,124 S * 9/2009 Cross D6/362
D676,253 S * 2/2013 Springs D6/362
8,678,489 B1 * 3/2014 Skinner A01M 31/02
297/16.1
8,757,724 B2 * 6/2014 Woodhams A01M 31/02
297/451.3
8,770,348 B2 * 7/2014 Springs A45F 3/26
182/187
8,894,139 B1 * 11/2014 Coffey A47C 4/286
297/45
9,277,807 B2 * 3/2016 Tichenor A47B 5/02
D878,070 S * 3/2020 Teal, Jr. D6/362
10,655,357 B1 * 5/2020 Graham E04H 15/30
2015/0204479 A1 * 7/2015 Bryant F16M 11/26
348/376
2016/0338477 A1 * 11/2016 Browning A47G 9/08
2017/0295912 A1 * 10/2017 Meillan A45F 3/22
2019/0343267 A1 * 11/2019 Drew A45F 3/24
2019/0350375 A1 * 11/2019 Penn A45F 3/22
2020/0046107 A1 * 2/2020 Sabbagh A45F 3/22
2020/0240739 A1 * 7/2020 Cauley, Jr. F41A 23/16
2020/0263965 A1 * 8/2020 Hogan H04W 4/029

* cited by examiner

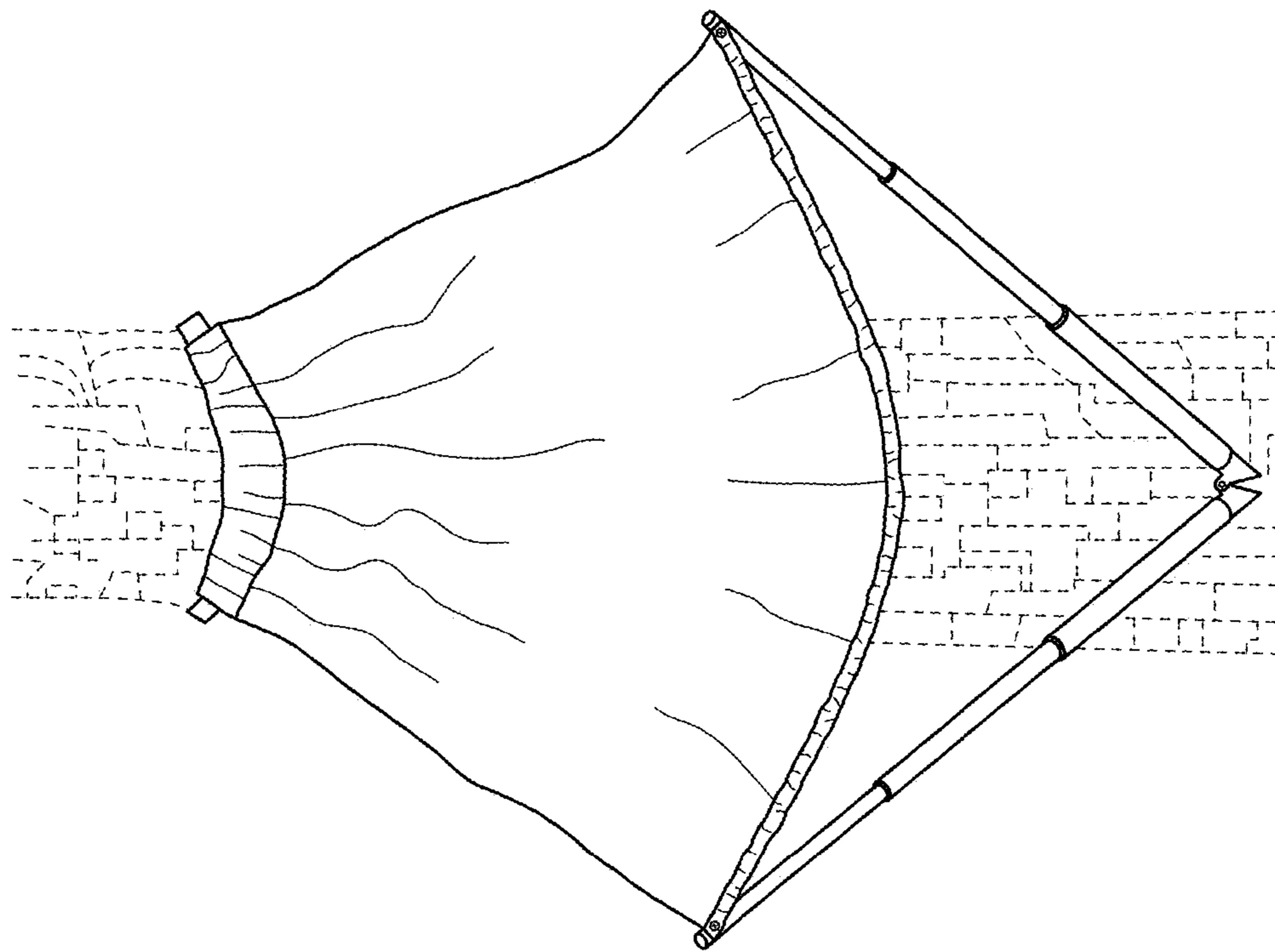

FIG. 1

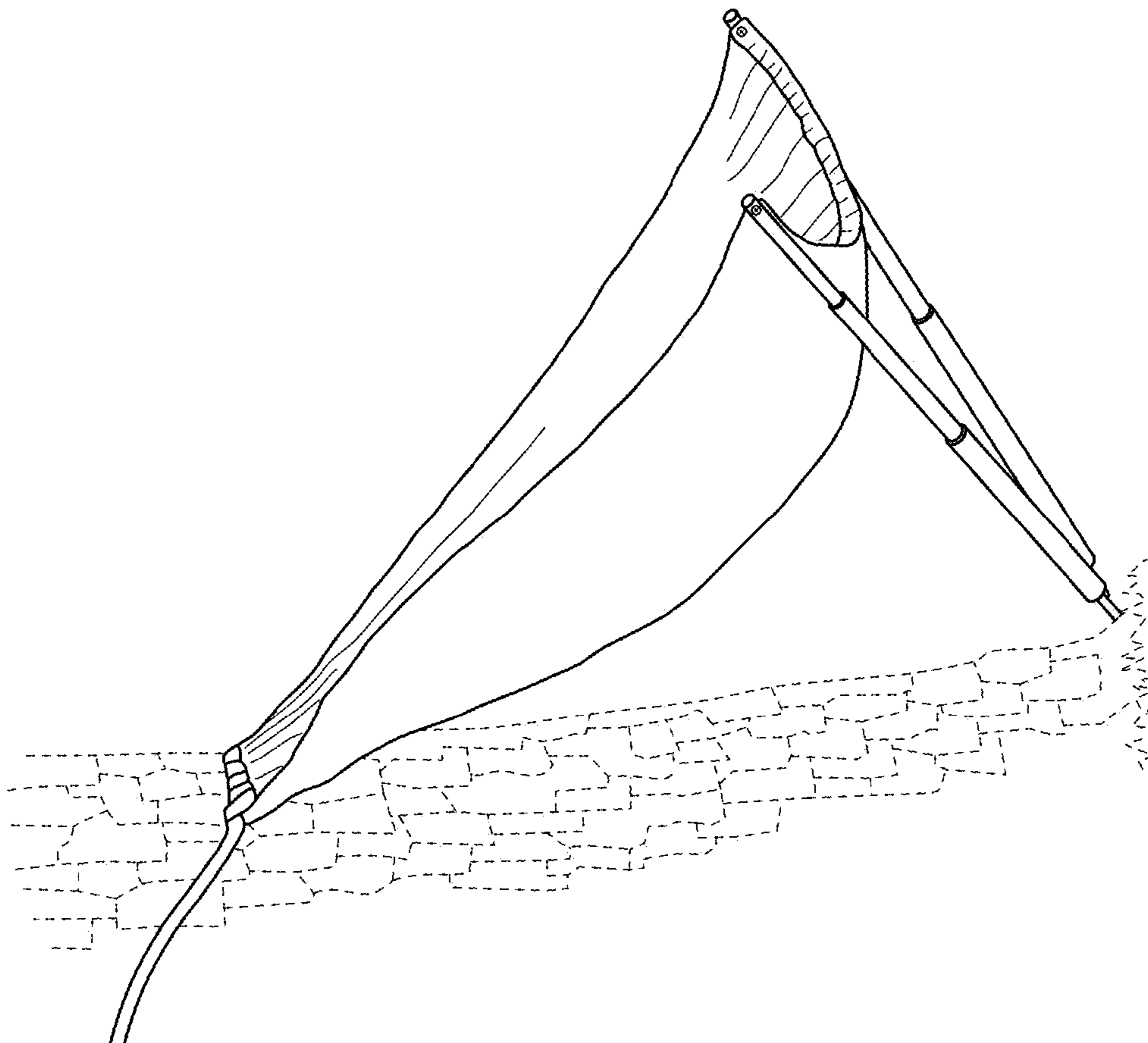

FIG. 2

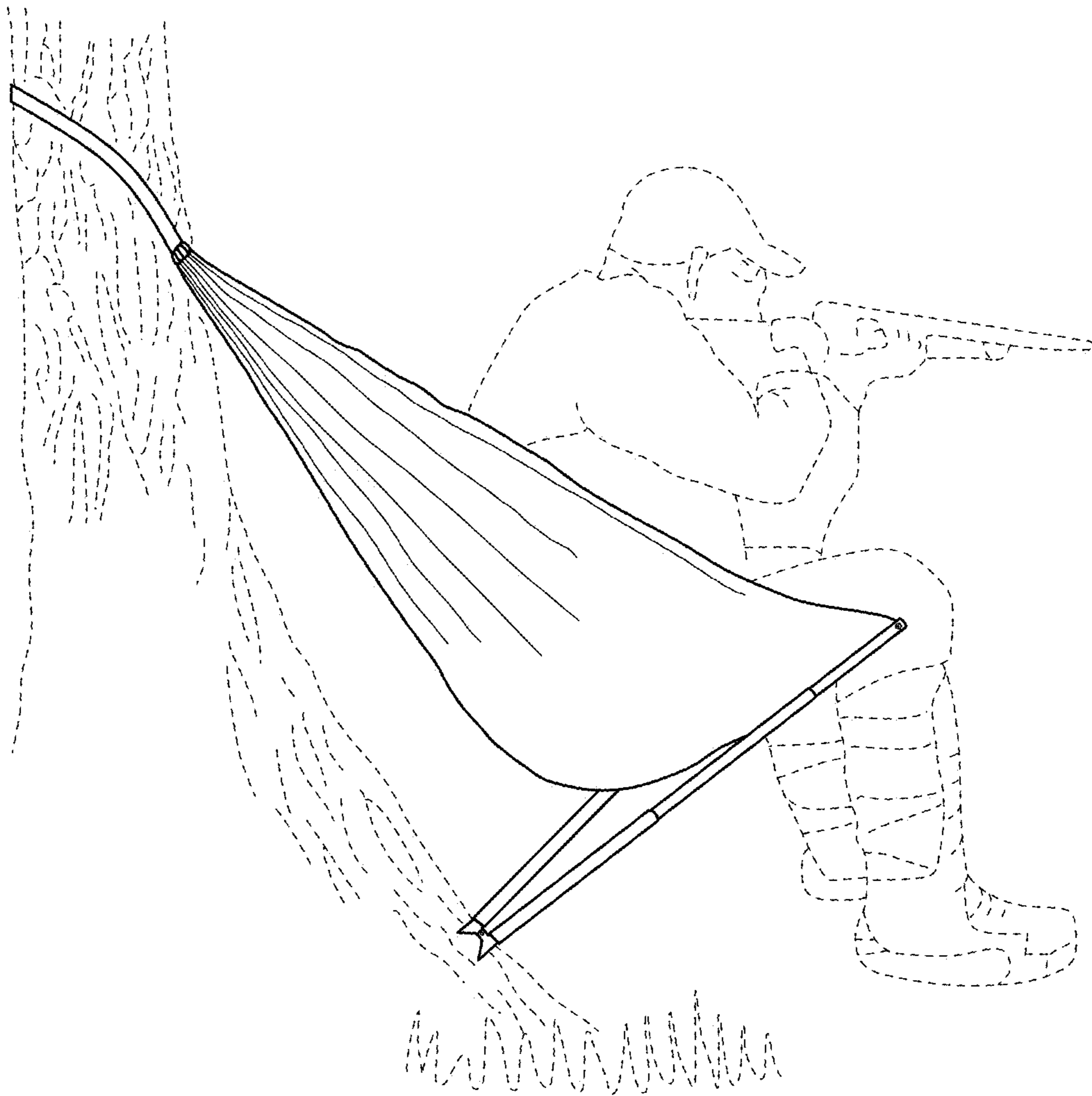

FIG. 3

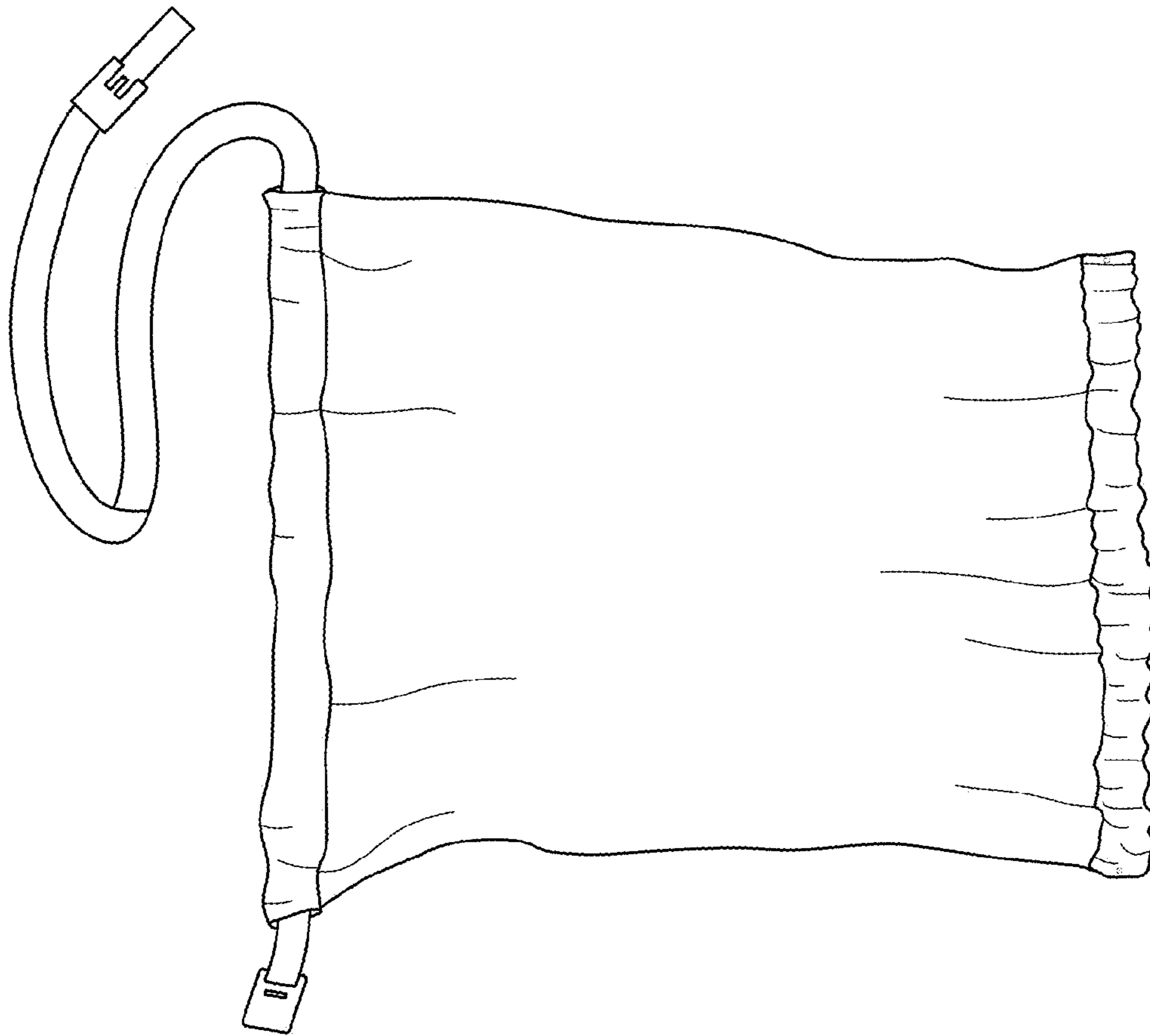

FIG. 5

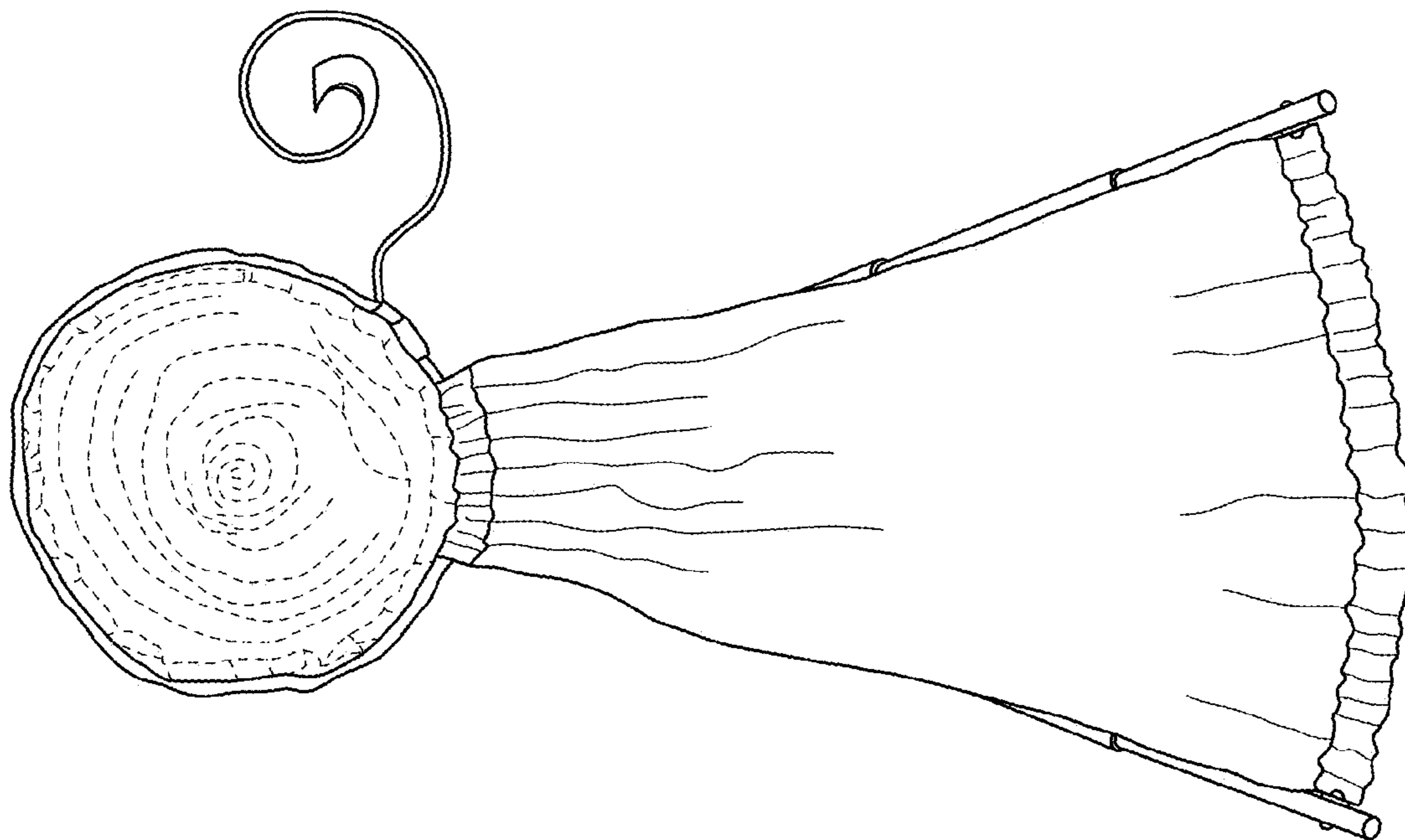

FIG. 4

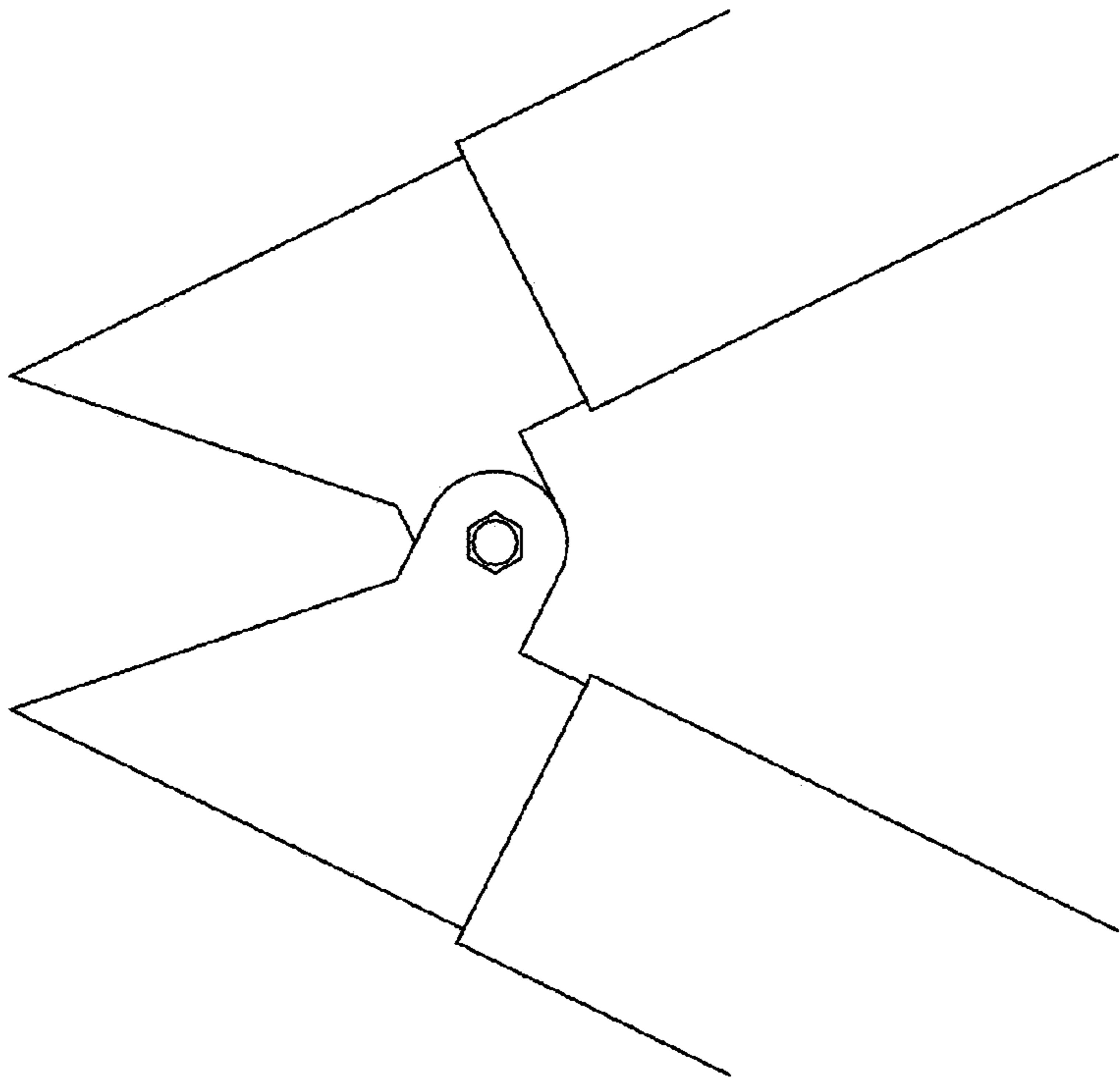

FIG. 8

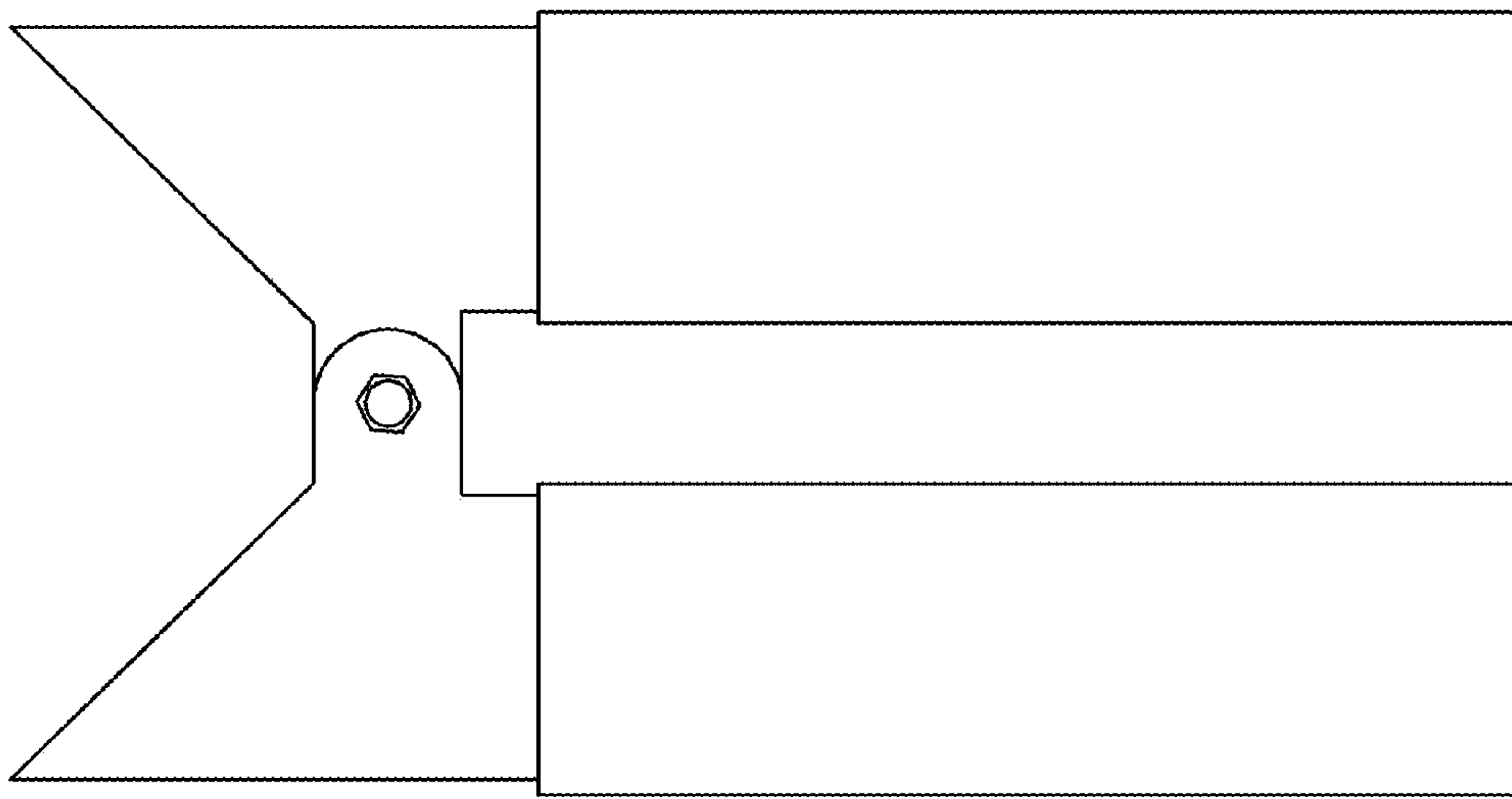

FIG. 7

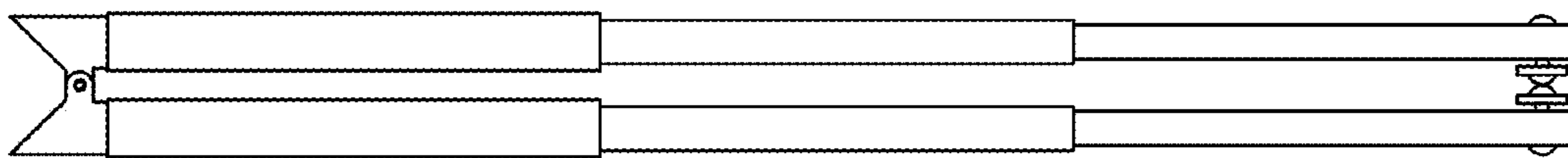

FIG. 6

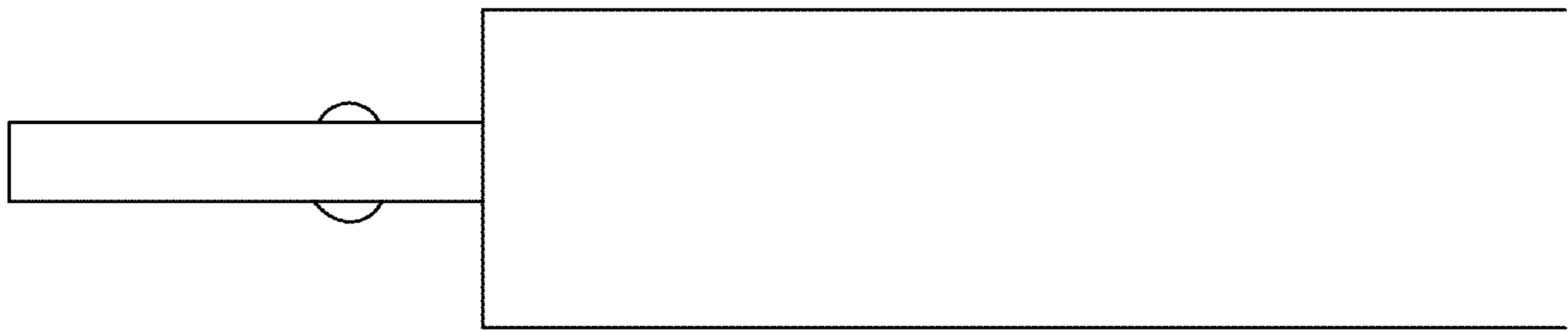

FIG. 9

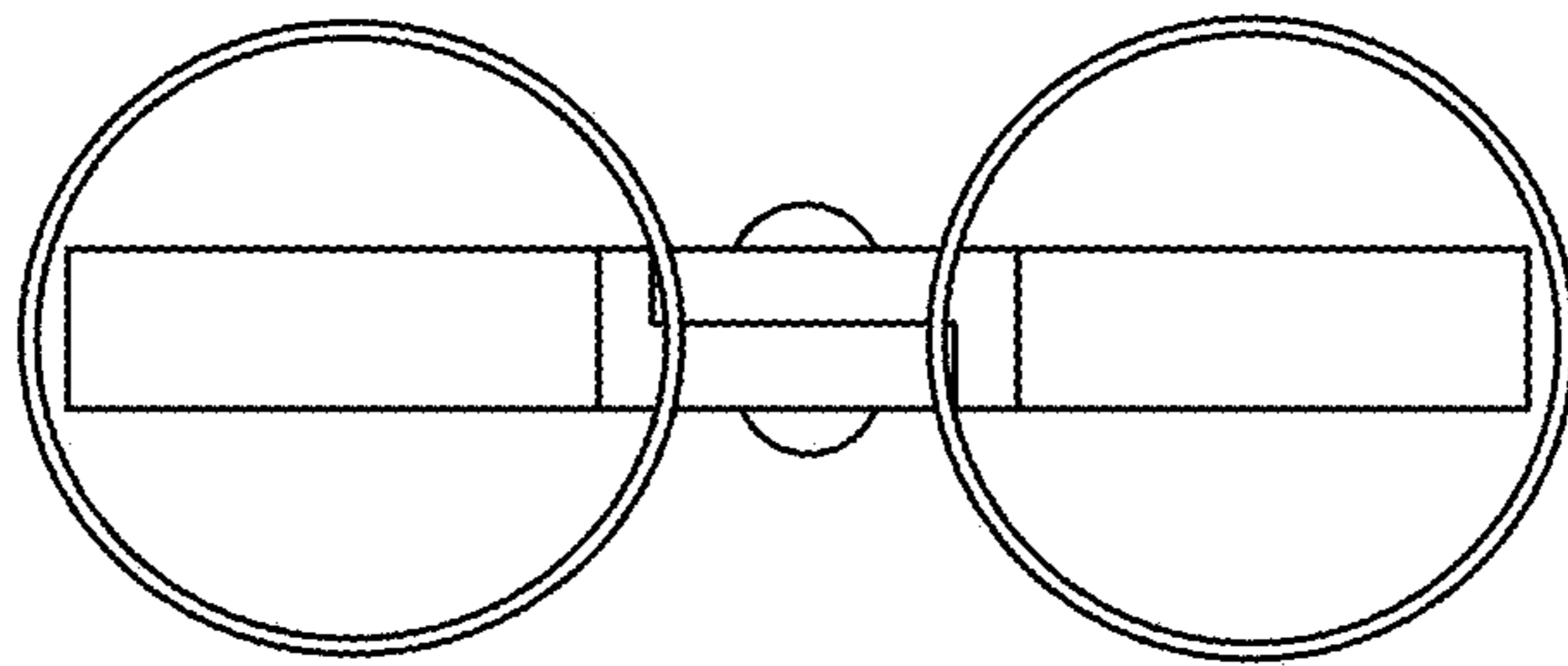

FIG. 10