



US00D933977S

(12) **United States Design Patent** (10) **Patent No.:** **US D933,977 S**
Kanhasamy (45) **Date of Patent:** **** Oct. 26, 2021**

(54) **REVERSIBLE SECTIONAL SOFA**

(71) Applicant: **Abedan Kanhasamy**, Mississauga (CA)

(72) Inventor: **Abedan Kanhasamy**, Mississauga (CA)

(**) Term: **15 Years**

(21) Appl. No.: **29/700,679**

(22) Filed: **Aug. 5, 2019**

(30) **Foreign Application Priority Data**

Jul. 24, 2019 (CA) 188884

(51) **LOC (13) Cl.** **06-01**

(52) **U.S. Cl.**
USPC **D6/335**

(58) **Field of Classification Search**
USPC D6/334, 335, 346, 357, 361, 367, 368,
D6/374, 375, 377-381; 297/16.1, 34, 42,
297/44, 118

(Continued)

(56) **References Cited**

U.S. PATENT DOCUMENTS

D384,827 S * 10/1997 Hutton D6/334

D675,460 S * 2/2013 Kanhasamy D6/381

(Continued)

Primary Examiner — W. A. Teddy Falloway

(74) *Attorney, Agent, or Firm* — Harness, Dickey & Pierce, P.L.C.

(57) **CLAIM**

The ornamental design for a reversible sectional sofa, as shown and described.

DESCRIPTION

FIG. 1 is a front view of the reversible sectional sofa in a first configuration in a first position;

FIG. 2 is a front, right side, perspective view of the reversible sectional sofa in the first configuration in the first position;

FIG. 3 is a front, right side, perspective view of the reversible sectional sofa in the first configuration in a second position;

FIG. 4 is a front, right side, perspective view of the reversible sectional sofa in the first configuration in a third position, shown with a pillow removed;

FIG. 5 is a front, right side, perspective view of the reversible sectional sofa in the first configuration in a fourth position;

FIG. 6 is a right side view of the reversible sectional sofa in the first configuration in the first position;

FIG. 7 is a front, right side, perspective view of the reversible sectional sofa in the first configuration in a fifth position;

FIG. 8 is a back view of the reversible sectional sofa in the first configuration in the first position;

FIG. 9 is a front view of the reversible sectional sofa in a second configuration in the first position;

FIG. 10 is a front, right side, perspective view of the reversible sectional sofa in the second configuration in the first position;

FIG. 11 is a front, right side, perspective view of the reversible sectional sofa in the second configuration in the second position;

FIG. 12 is a front, right side, perspective view of the reversible sectional sofa in the second configuration in the third position, shown with a pillow removed;

FIG. 13 is a front, right side, perspective view of the reversible sectional sofa in the second configuration in the fourth position;

FIG. 14 is a right side view of the reversible sectional sofa in the second configuration in the first position;

FIG. 15 is a front, right side, perspective view of the reversible sectional sofa in the second configuration in the fifth position; and,

FIG. 16 is a back view of the reversible sectional sofa in the second configuration in the first position.

1 Claim, 16 Drawing Sheets

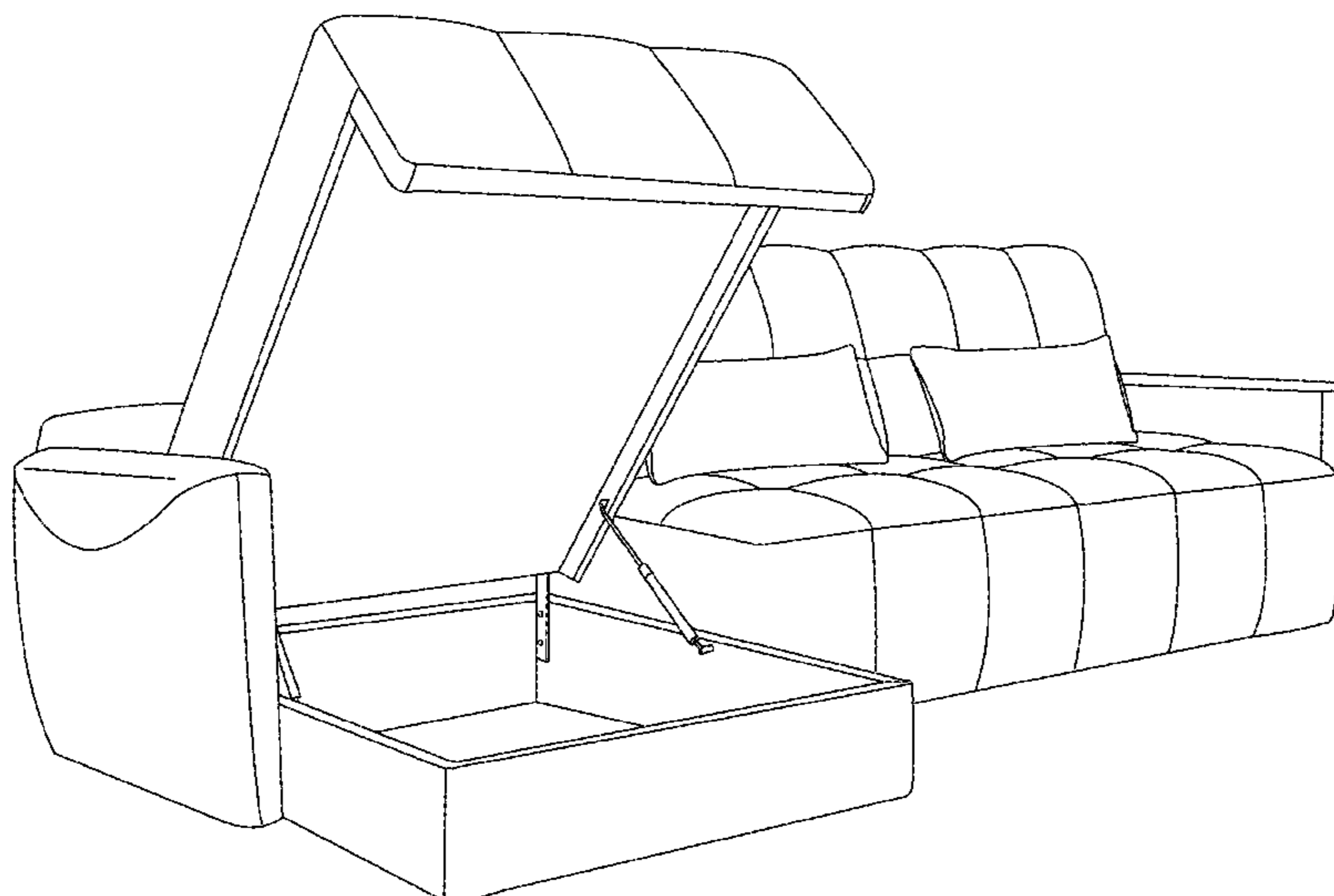

(58) **Field of Classification Search**

CPC A47C 1/00; A47C 1/02; A47C 1/04; A47C
 17/02; A47C 17/04; A47C 17/045; A47C
 17/13; A47C 17/132; A47C 17/134; A47C
 17/161; A47C 17/162; A47C 17/163;
 A47C 17/17; A47C 17/16; A47C 17/18;
 A47C 17/20; A47C 17/86

See application file for complete search history.

(56) **References Cited**

U.S. PATENT DOCUMENTS

D677,070 S * 3/2013 Kanthasamy D6/381
 D677,071 S * 3/2013 Kanthasamy D6/381
 D681,366 S * 5/2013 Kanthasamy D6/381
 D714,567 S * 10/2014 Podsiadlo D6/381
 D717,063 S * 11/2014 Zhang D6/381
 D719,755 S * 12/2014 Kanthasamy D6/381
 D719,757 S * 12/2014 Sonmez D6/381
 D719,758 S * 12/2014 Sonmez D6/381
 D731,198 S * 6/2015 Podsiadlo D6/381

D799,222 S * 10/2017 Pathiratne D6/335
 D804,834 S * 12/2017 Kanthasamy D6/335
 D829,452 S * 10/2018 Kanthasamy D6/335
 D836,349 S * 12/2018 Kanthasamy D6/335
 D836,350 S * 12/2018 Kanthasamy D6/335
 D841,992 S * 3/2019 Kershner D6/335
 D853,141 S * 7/2019 Aubry D6/369
 D871,791 S * 1/2020 Carter D6/377
 D891,128 S * 7/2020 Kanthasamy D6/335
 D891,129 S * 7/2020 Kanthasamy D6/335
 D891,130 S * 7/2020 Kanthasamy D6/335
 D904,042 S * 12/2020 Kanthasamy D6/335
 D904,772 S * 12/2020 Kanthasamy D6/335
 D905,453 S * 12/2020 Kanthasamy D6/335
 D905,454 S * 12/2020 Kanthasamy D6/335
 2011/0016626 A1 * 1/2011 Kanthasamy A47C 17/16
 5/37.1
 2012/0297535 A1 * 11/2012 Kanthasamy A47C 17/162
 5/12.1
 2018/0296001 A1 * 10/2018 Tucker A47C 17/12
 2020/0146458 A1 * 5/2020 Kanthasamy A47C 19/22

* cited by examiner

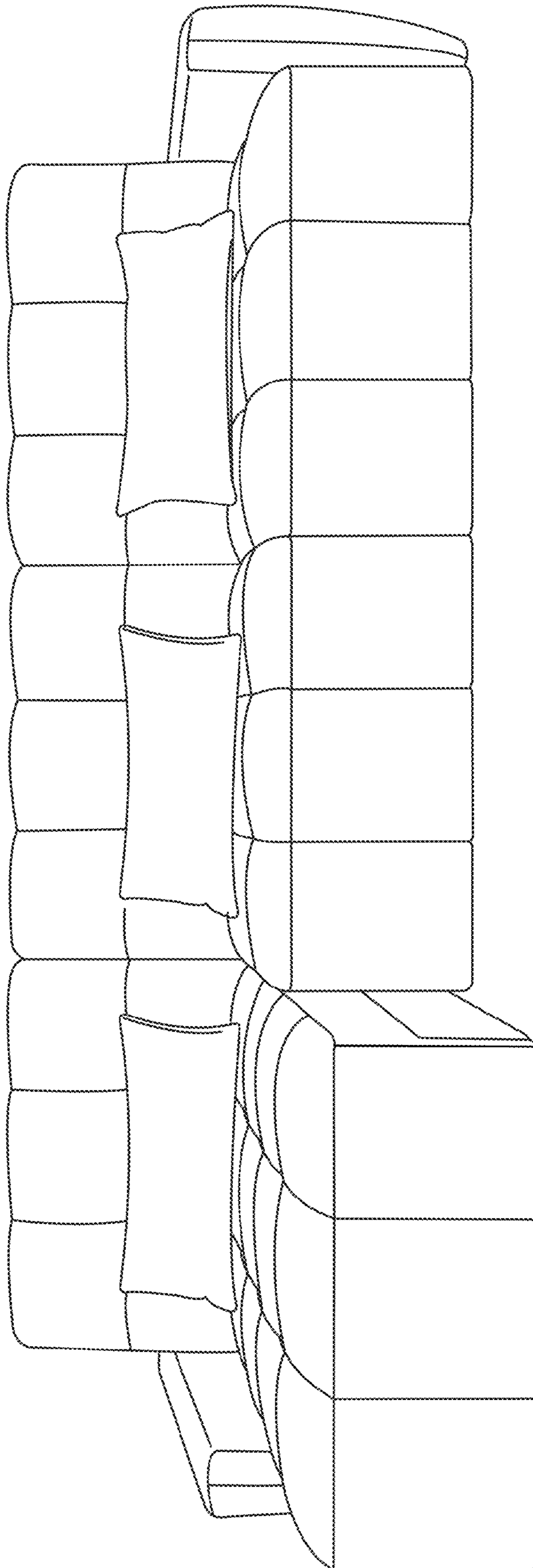

FIG. 1

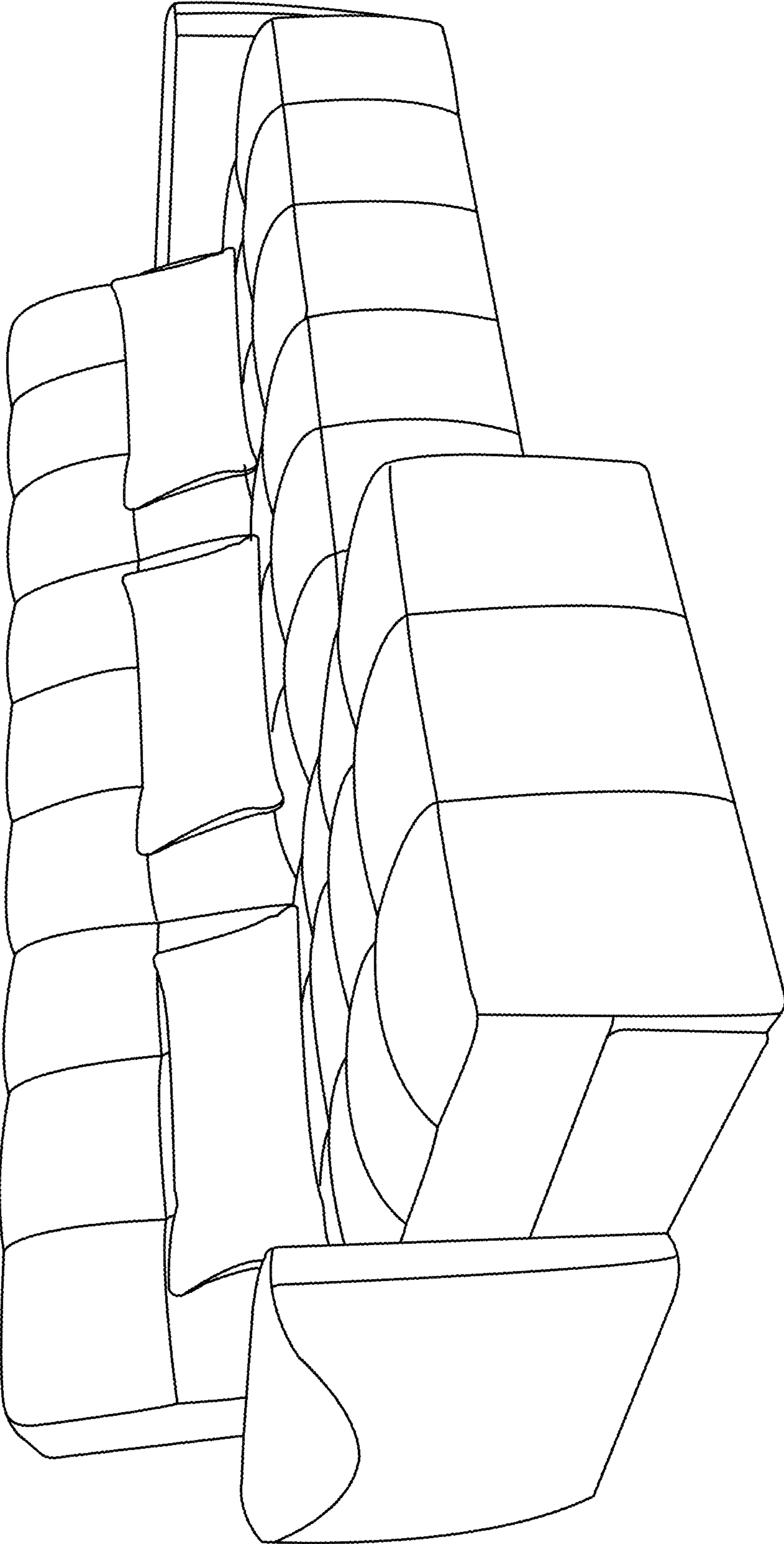

FIG. 2

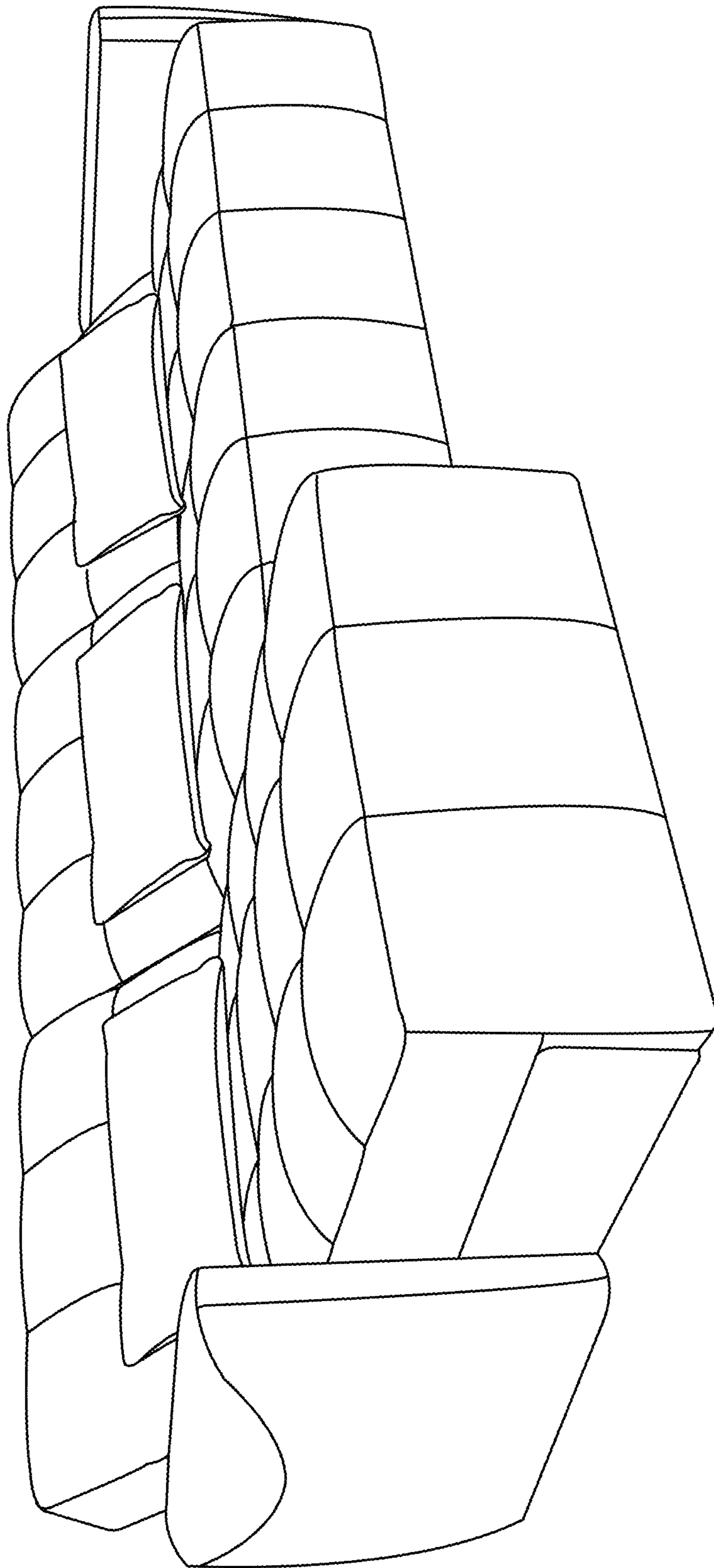

FIG. 3

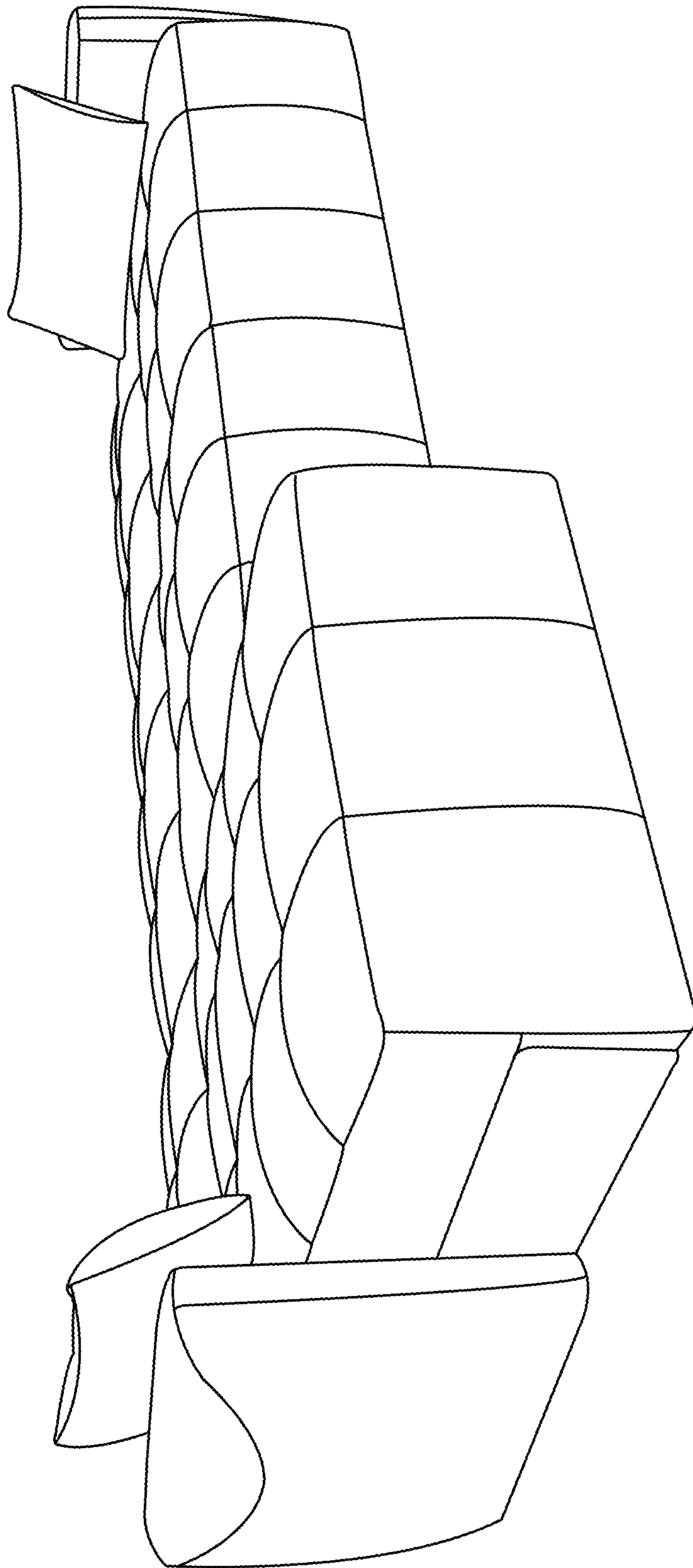

FIG. 4

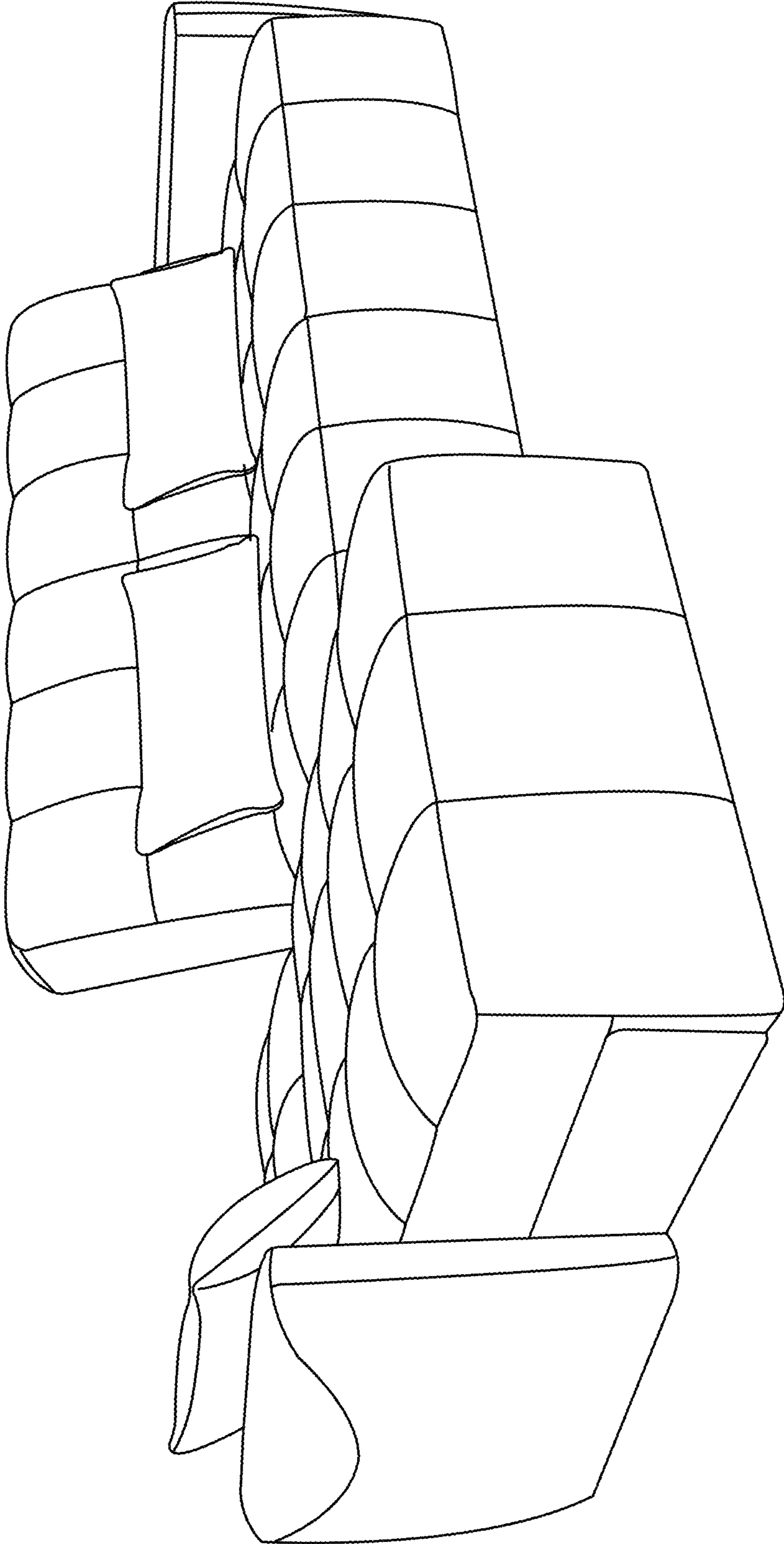

FIG. 5

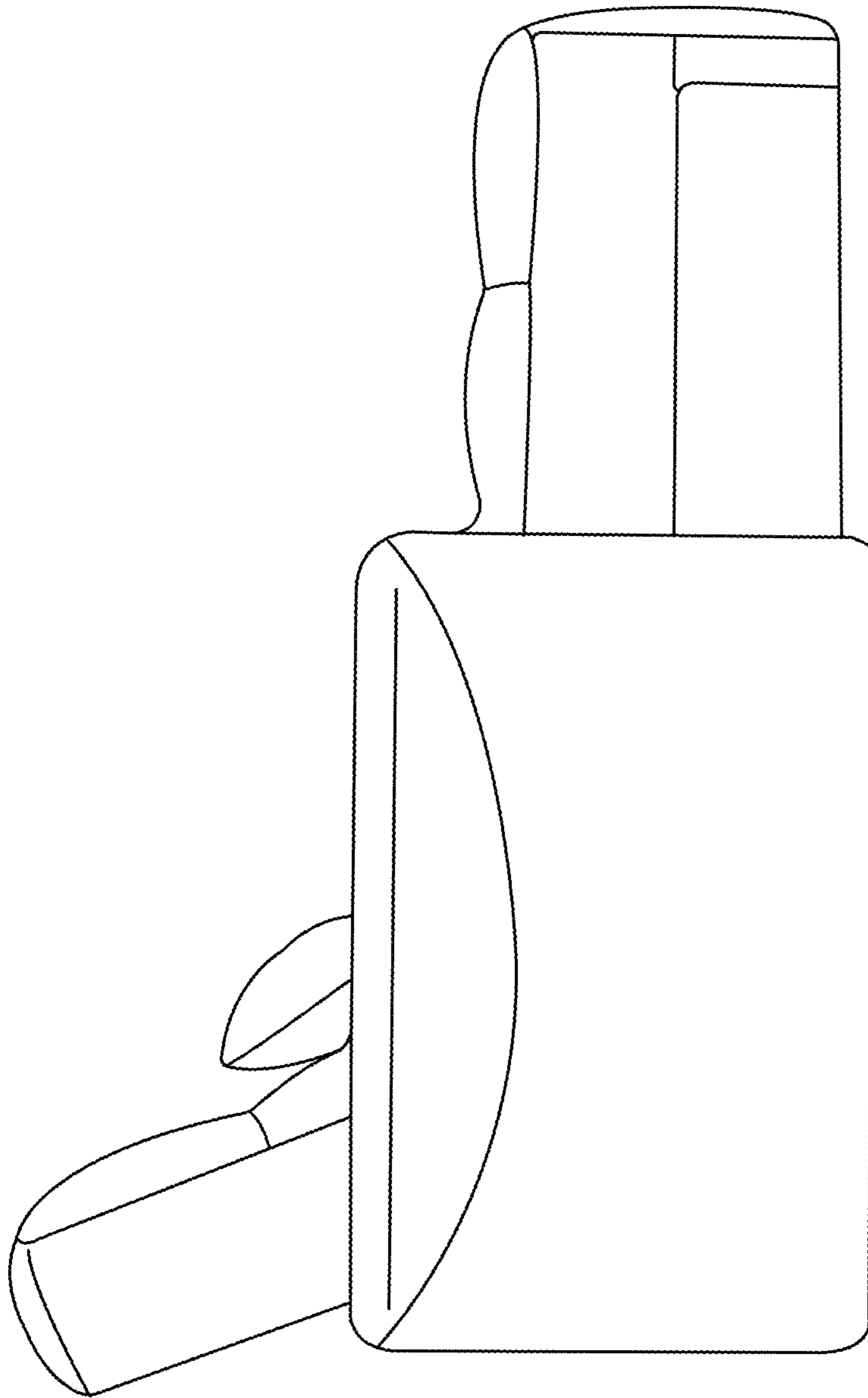

FIG. 6

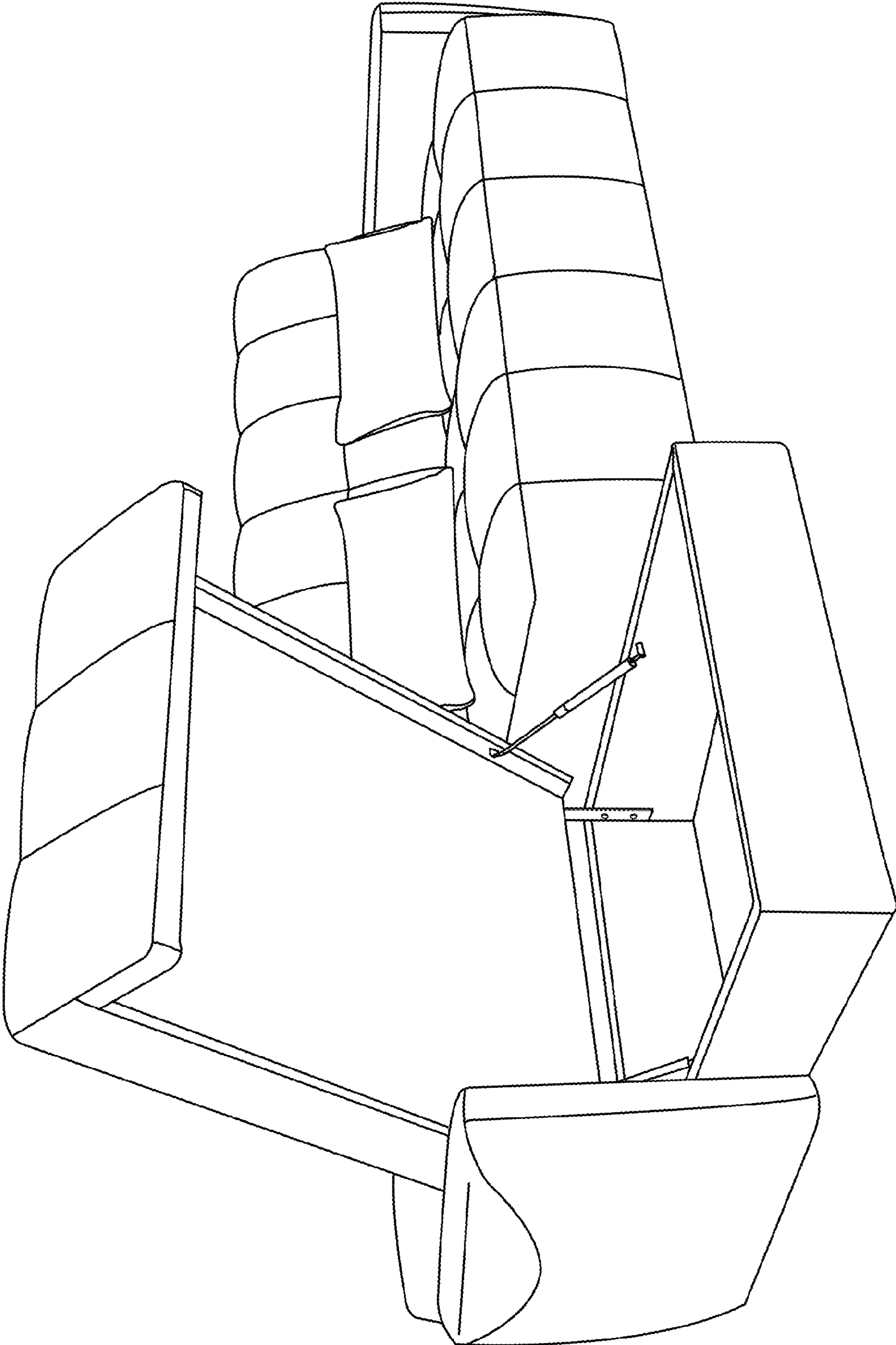

FIG. 7

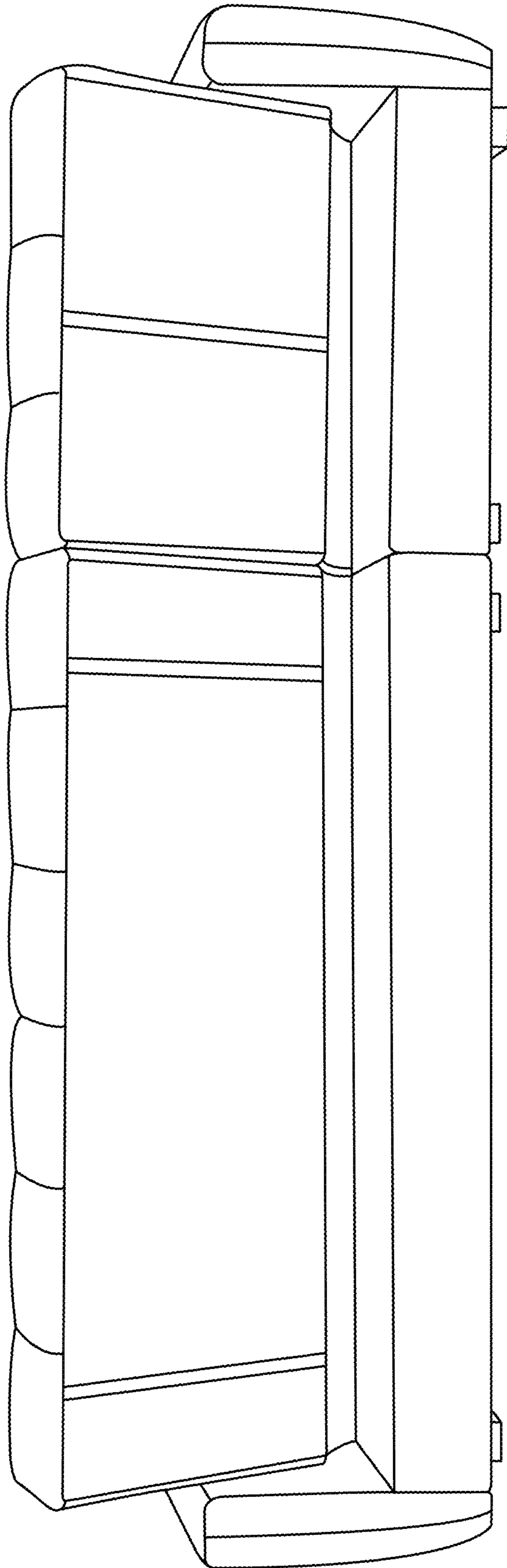

FIG. 8

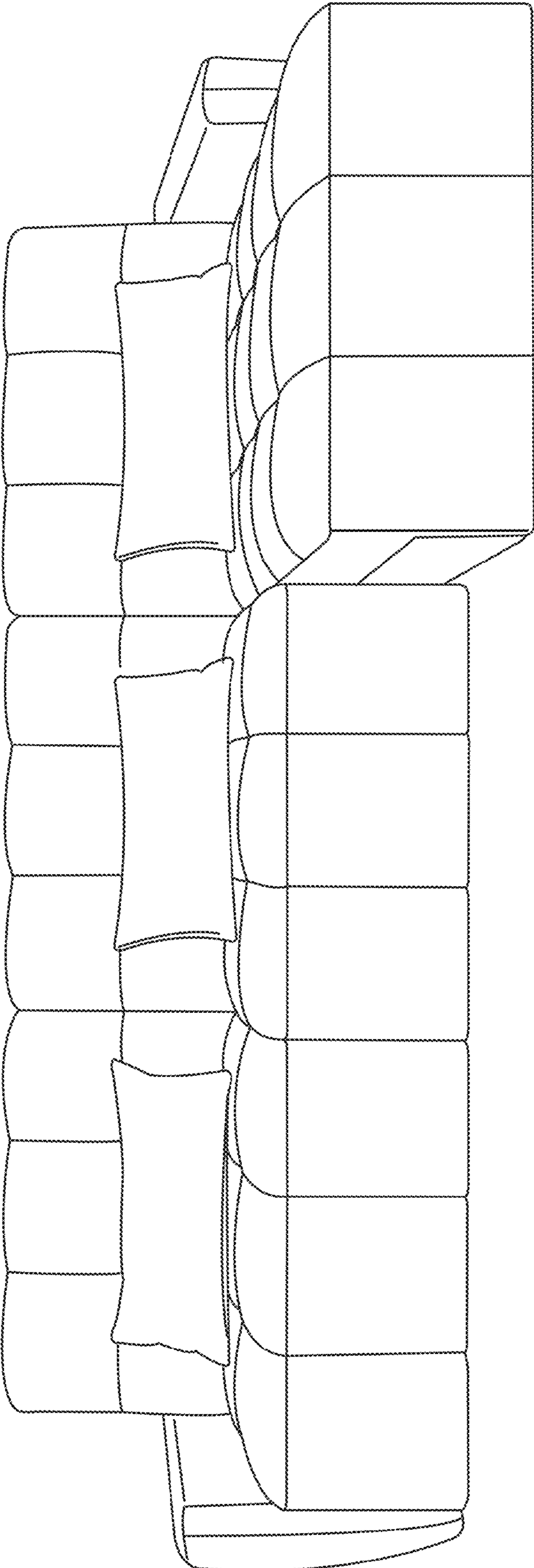

FIG. 9

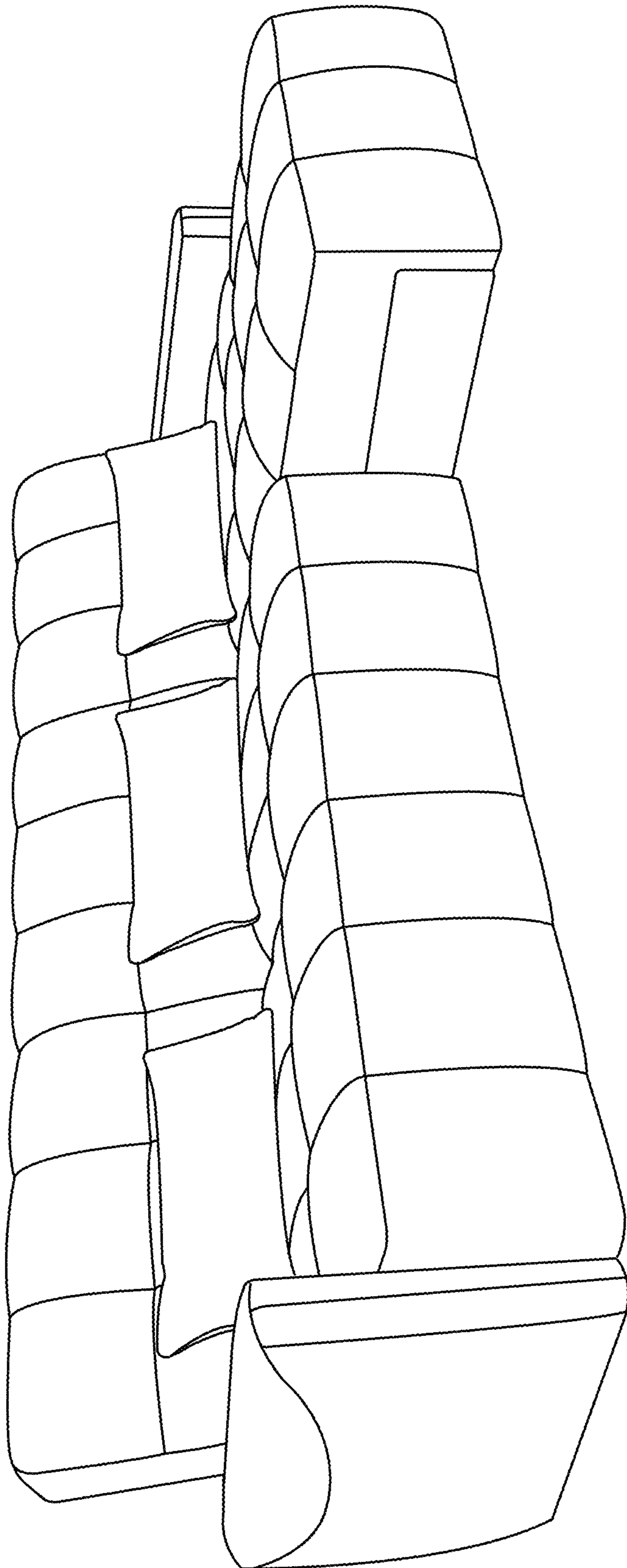

FIG. 10

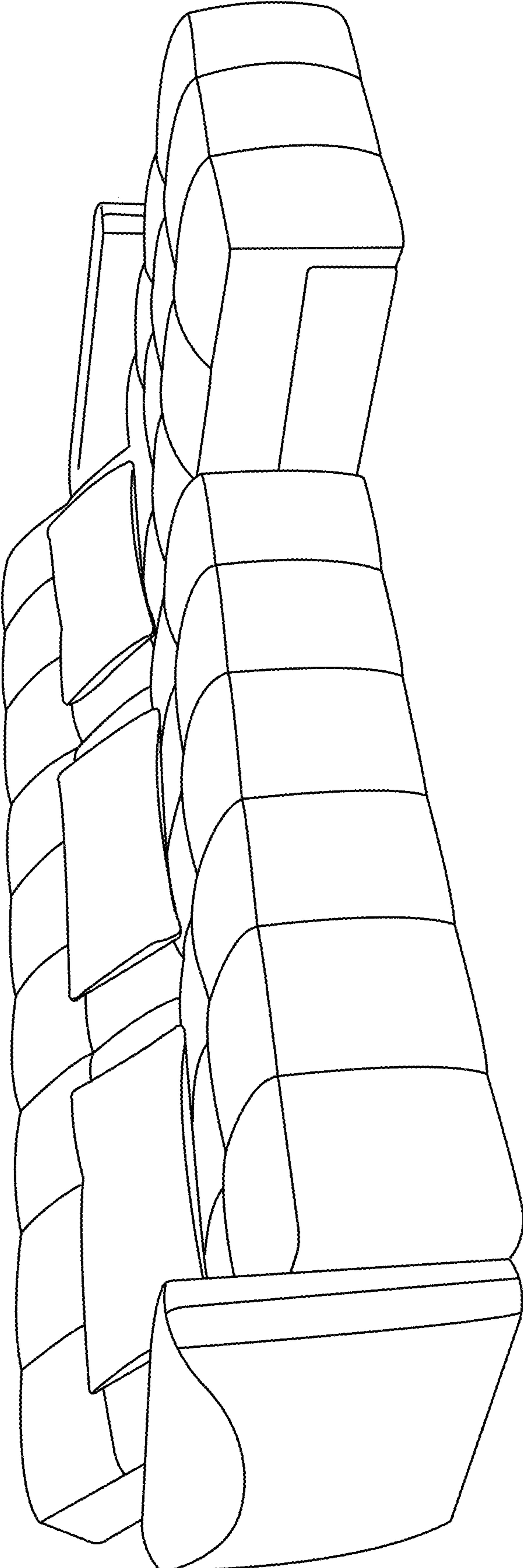

FIG. 11

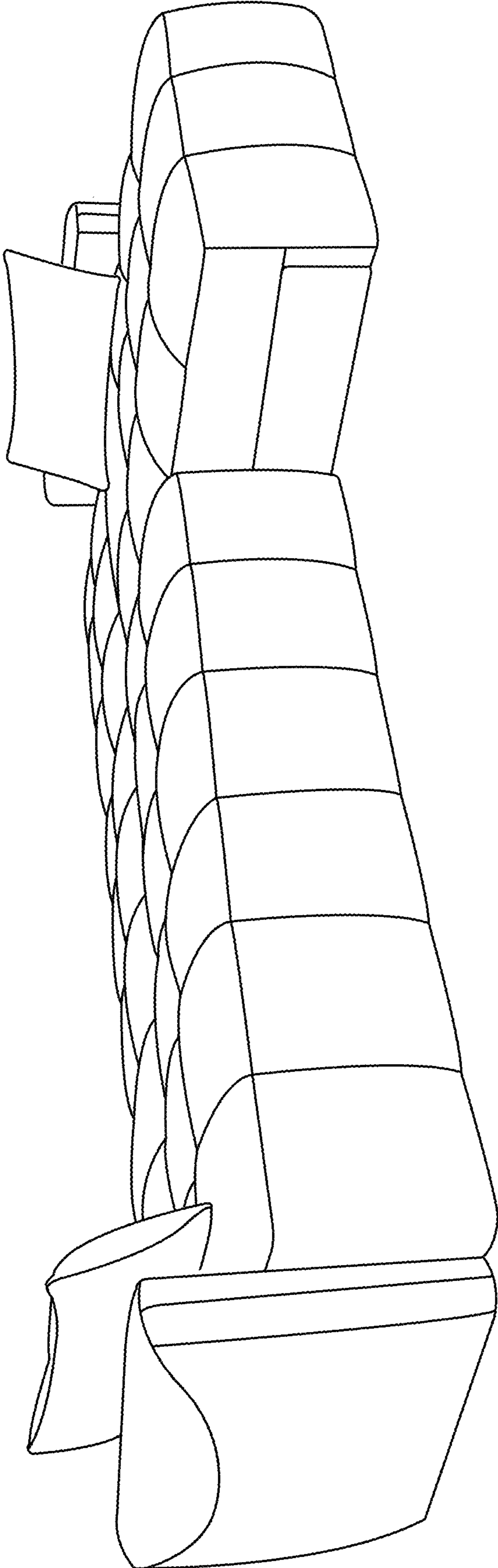

FIG. 12

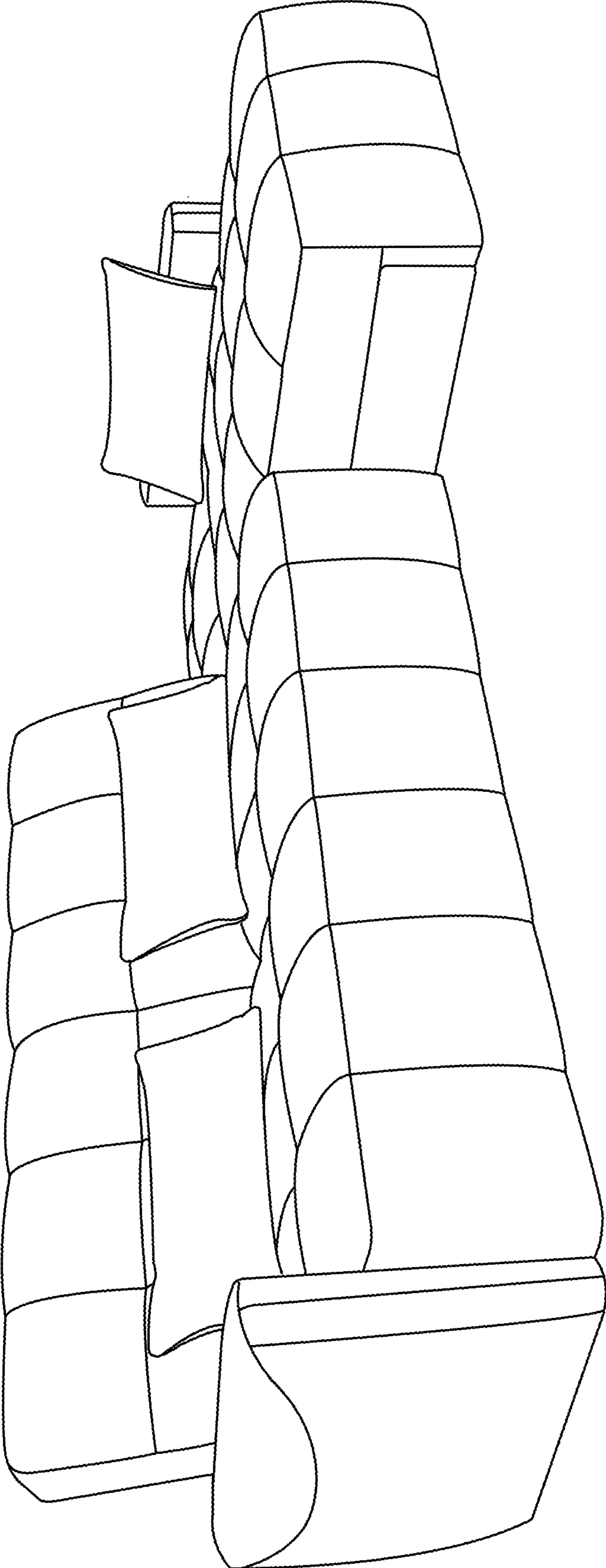

FIG. 13

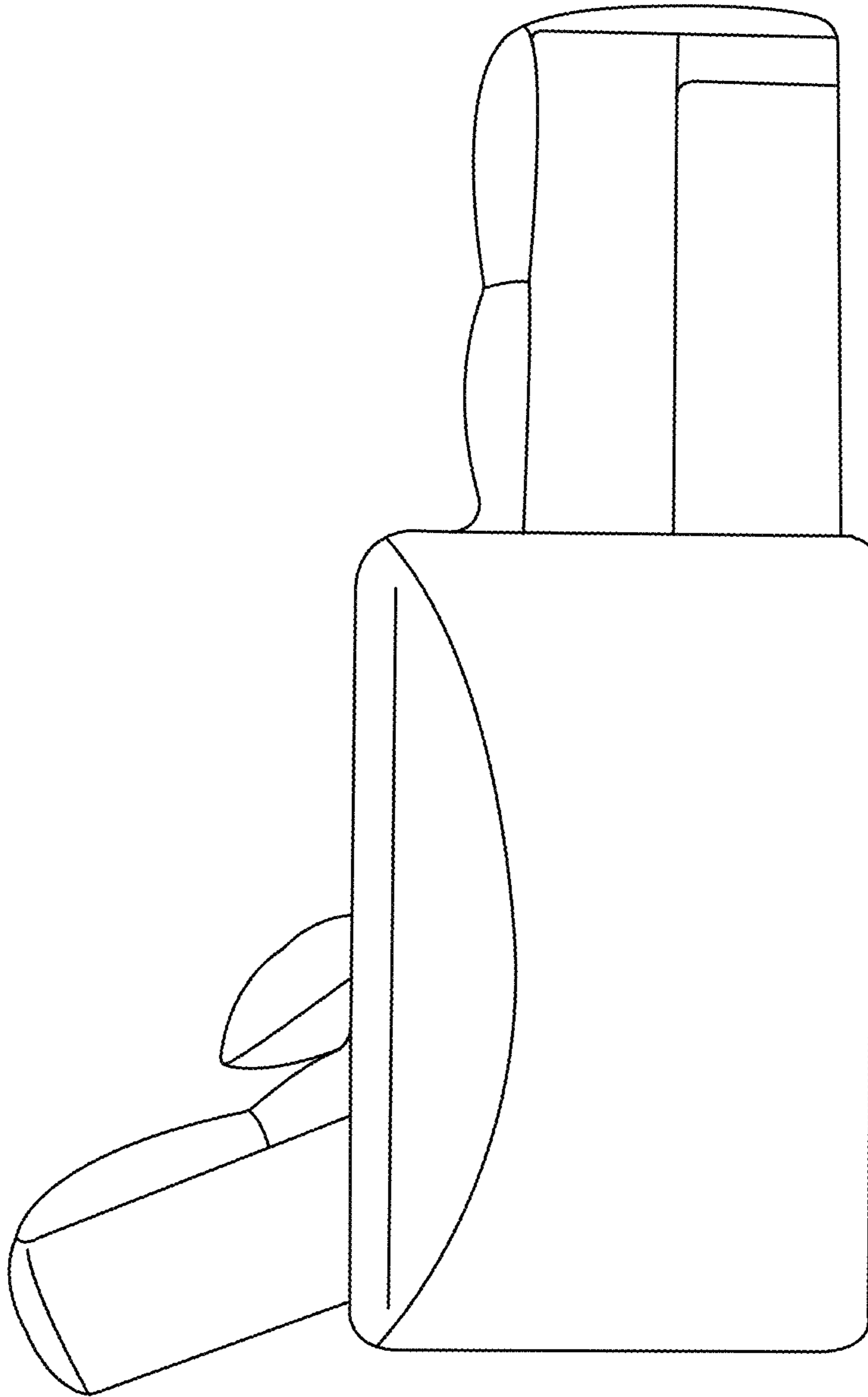

FIG. 14

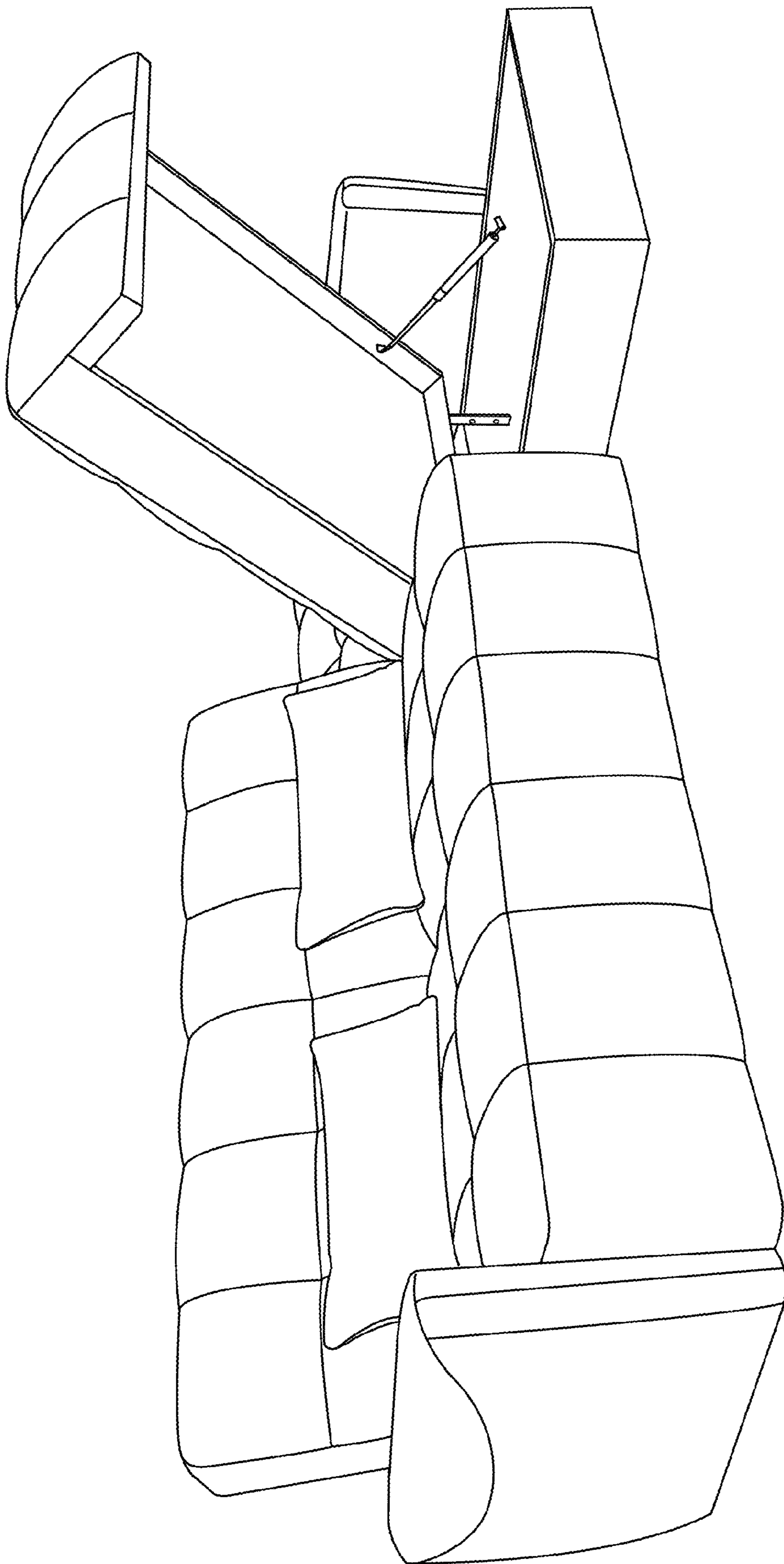

FIG. 15

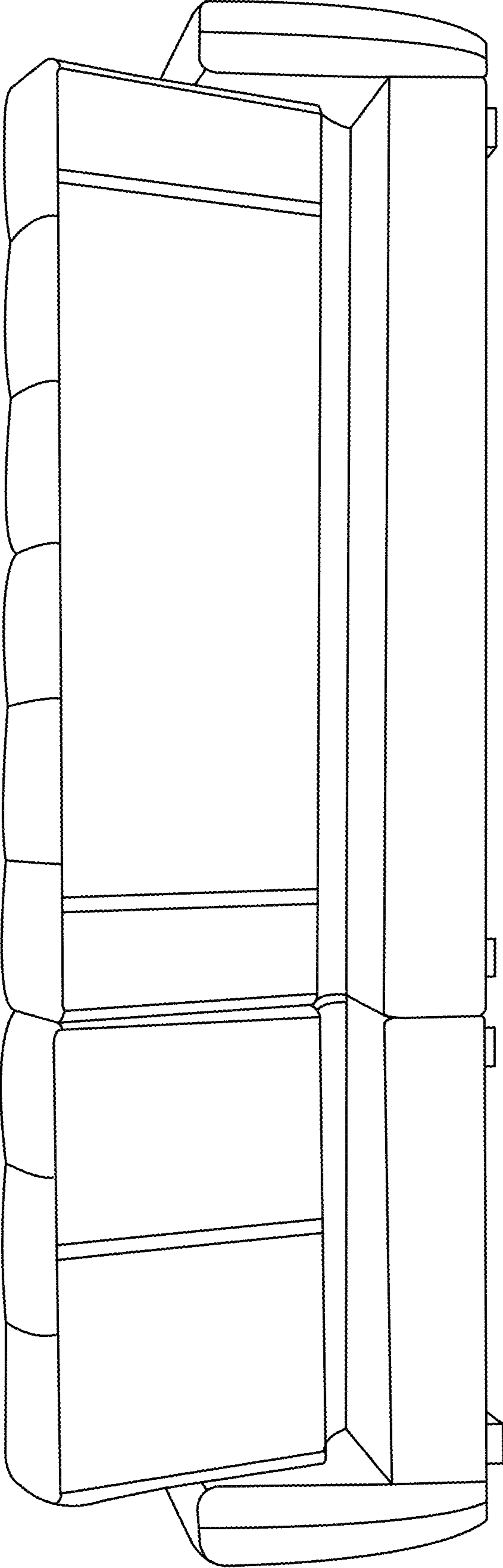

FIG.16