



US00D933947S

(12) **United States Design Patent**
Tarenne

(10) **Patent No.:** **US D933,947 S**

(45) **Date of Patent:** **** Oct. 26, 2021**

(54) **FOOTWEAR ARTICLE**

(71) Applicant: **Salomon S.A.S.**, Epagny Metz-Tessy (FR)

(72) Inventor: **Baptiste Tarenne**, Pringy (FR)

(73) Assignee: **Salomon S. A.S.**, Metz-Tessy (FR)

(**) Term: **15 Years**

(21) Appl. No.: **29/718,595**

(22) Filed: **Dec. 26, 2019**

(30) **Foreign Application Priority Data**

Jun. 27, 2019 (WO) DM/202 482

(51) **LOC (13) Cl.** **02-04**

(52) **U.S. Cl.**
USPC **D2/972; D2/973**

(58) **Field of Classification Search**
USPC D2/902-907, 944-946, 947, 949, 969,
D2/971-976, 977, 978
CPC A43B 5/00; A43B 5/08; A43B 5/10; A43B
23/00; A43B 23/02; A43B 23/0205; A43B
23/021; A43B 23/0215; A43B 23/0235;
A43B 23/024; A43B 23/0245; A43B
23/025; A43B 23/0255; A43B 23/026;
A43B 23/0295; A43B 23/24; A43B
23/25; A43B 1/00; A43B 1/009; A43B
1/02; A43B 1/10; A43B 1/12; A43B 1/14
See application file for complete search history.

(56) **References Cited**

U.S. PATENT DOCUMENTS

D294,766 S * 3/1988 Igoe D2/907
D296,261 S * 6/1988 Brown D2/973
D299,182 S * 1/1989 Brown D2/969
4,833,795 A * 5/1989 Diaz A43B 13/184
36/11.5
D314,662 S * 2/1991 Quan D2/973

D401,755 S 12/1998 Zinovieff
D404,542 S 1/1999 Donnadieu et al.
D404,543 S 1/1999 Donnadieu et al.
D412,131 S 7/1999 Bent et al.
D413,427 S 11/1999 Fellouhe
D415,875 S 11/1999 Falguere

(Continued)

OTHER PUBLICATIONS

Amazon.com, Salomon Men's Sense Ride 3, announced Aug. 12, 2019 [online], [site visited Apr. 30, 2021]. Available from internet, URL: <https://www.amazon.com/Salomon-Mens-SENSE-Trail-Running/dp/B0873ZWXNY> (Year: 2019).*

Primary Examiner — Elizabeth J Oswecki

Assistant Examiner — Yelizaveta Y Masalimova

(74) *Attorney, Agent, or Firm* — Terence P. O'Brien

(57) **CLAIM**

The ornamental design for a footwear article, as shown and described.

DESCRIPTION

FIG. 1 is a front, side perspective view of a footwear article showing my new design;
FIG. 2 a top, side perspective view of the footwear article of FIG. 1;
FIG. 3 is a first side view of the footwear article of FIG. 1;
FIG. 4 is a second side view of the footwear article of FIG. 1;
FIG. 5 a front view of the footwear article of FIG. 1;
FIG. 6 is a rear view of the footwear article of FIG. 1; and,
FIG. 7 is a top view of the footwear article of FIG. 1.
The dot dashed broken lines in FIGS. 1-7 depict the boundaries of the claimed design. The even dashed broken lines in FIGS. 1-7 are directed to environment and form no part of the claimed design.

1 Claim, 7 Drawing Sheets

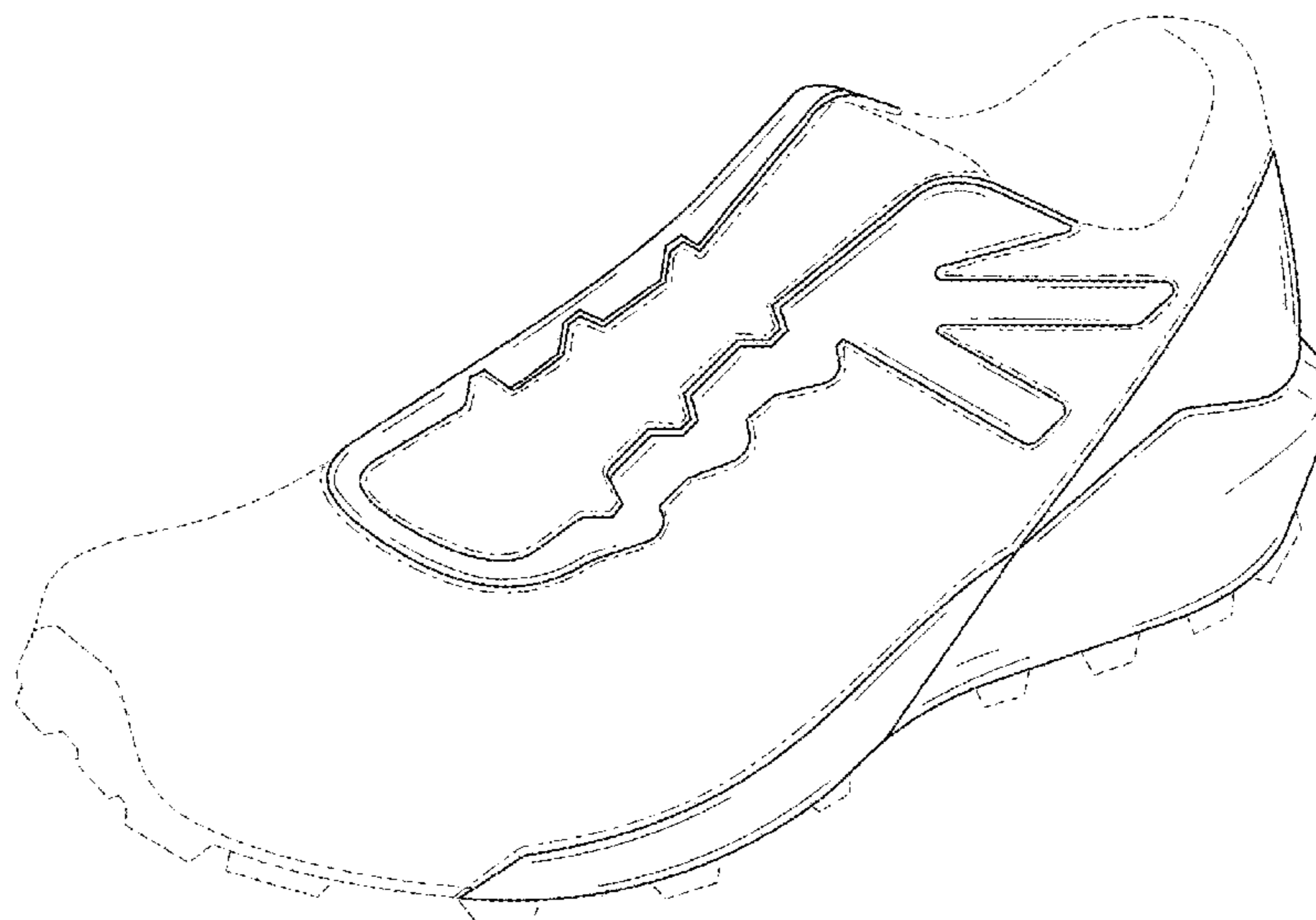

(56)

References Cited

U.S. PATENT DOCUMENTS

D740,537 S	10/2015	Fuhrer et al.	
D742,109 S	10/2015	Grenet	
D753,382 S	4/2016	Lamont	
D753,383 S	4/2016	Nikolic	
D777,412 S	1/2017	Antonelli	
D779,182 S *	2/2017	Hobson	D2/960
D789,061 S	6/2017	Nikolic	
D789,062 S	6/2017	Grenet	
D789,671 S	6/2017	Chung	
D790,187 S	6/2017	Portailler	
D790,188 S	6/2017	Portailler et al.	
D793,702 S *	8/2017	Parker	D2/972
D795,558 S *	8/2017	Rowe	D2/972
D799,806 S *	10/2017	Atwell	D2/972
D803,530 S	11/2017	Nikolic	
D812,873 S	3/2018	Lapouille	
D812,874 S	3/2018	Lapouille	
D812,879 S	3/2018	Lapouille	
D812,880 S	3/2018	Lapouille	
D815,422 S *	4/2018	Hobson	D2/972
D821,728 S *	7/2018	Sokol	D2/972
D824,651 S *	8/2018	Greenhalgh	D2/969
D850,064 S *	6/2019	Sinclair	D2/944
D852,487 S *	7/2019	Greenhalgh	D2/969
D867,739 S *	11/2019	Hobson	D2/969
2011/0113646 A1 *	5/2011	Merritt	A43B 13/145 36/28
2011/0302810 A1 *	12/2011	Borel	A43B 23/027 36/114

* cited by examiner

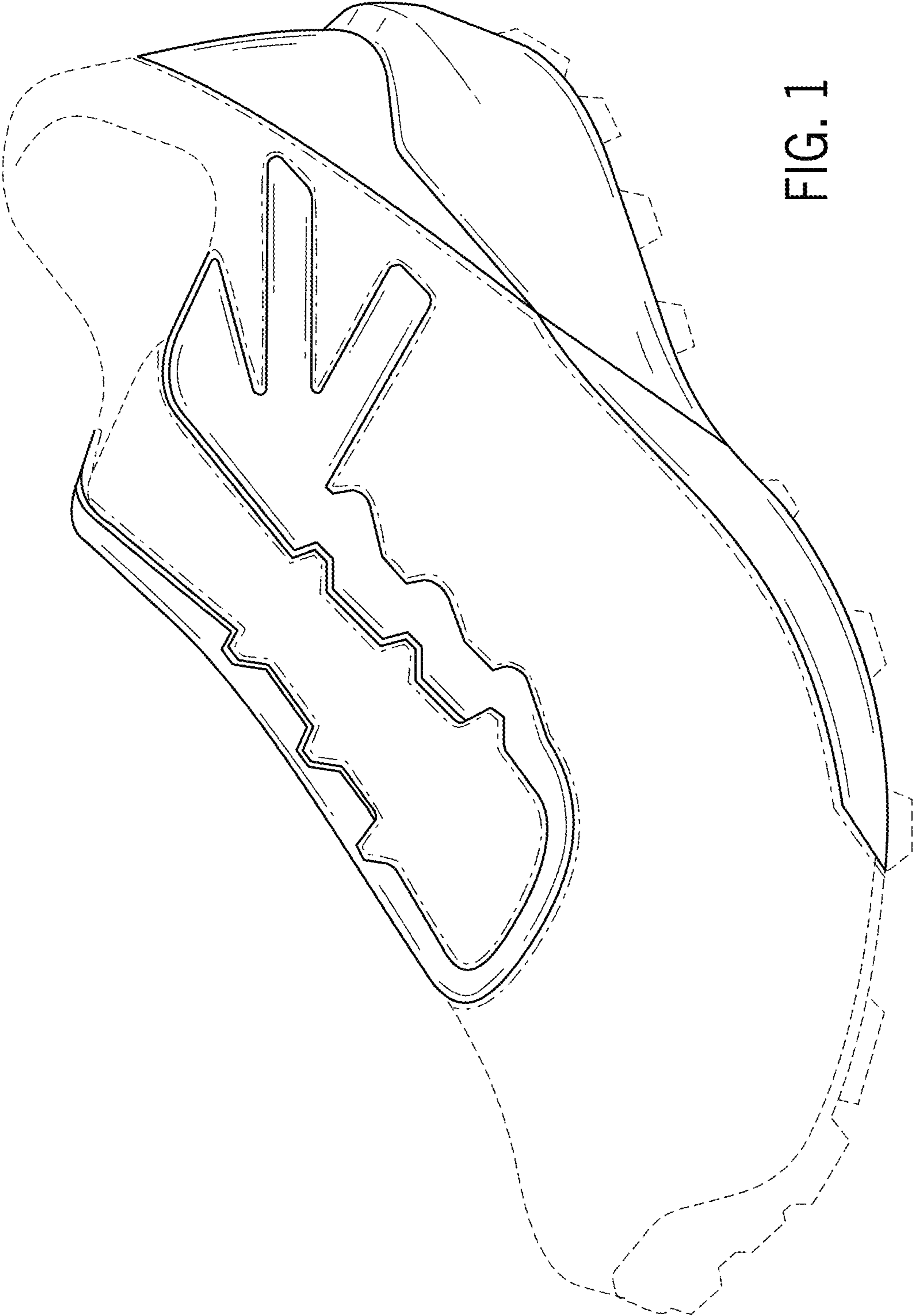

FIG. 1

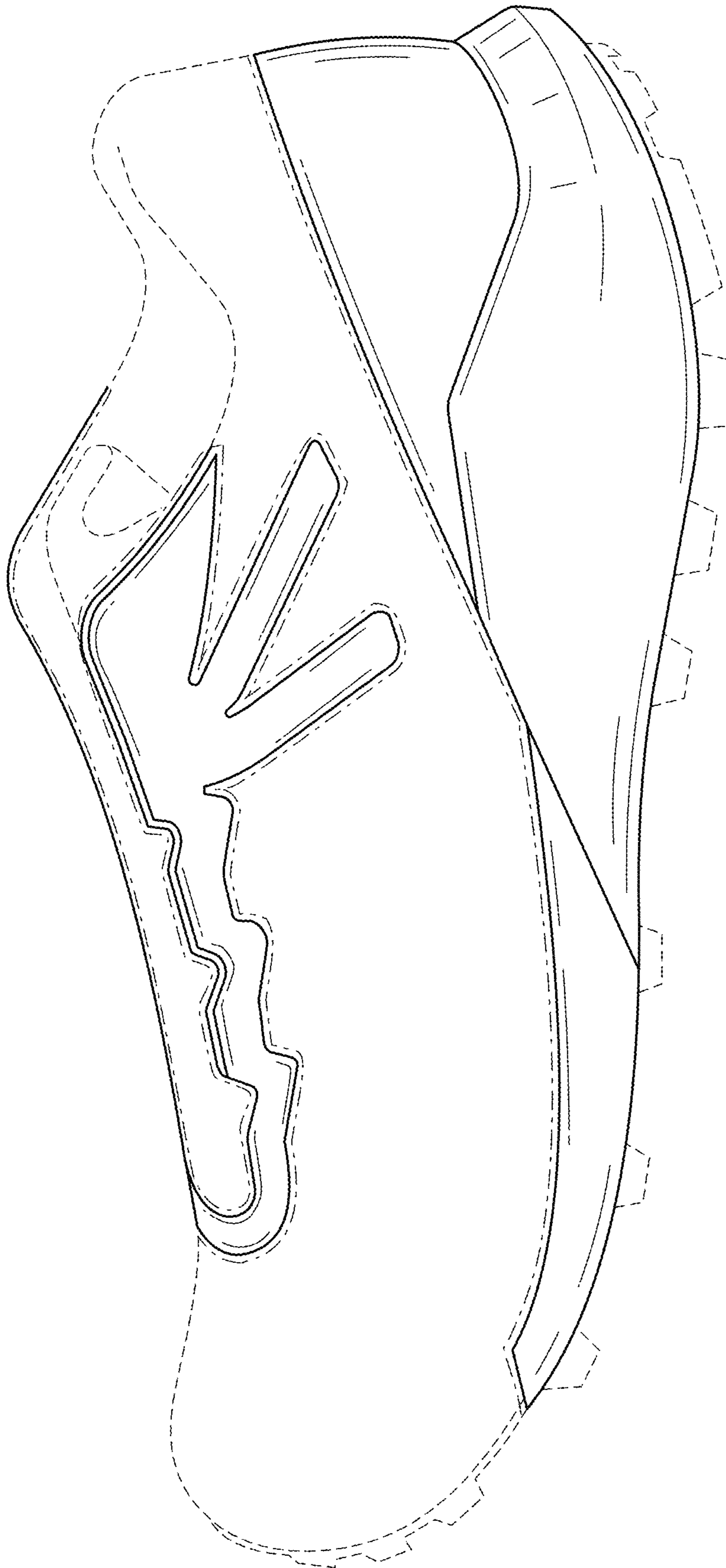

FIG. 2

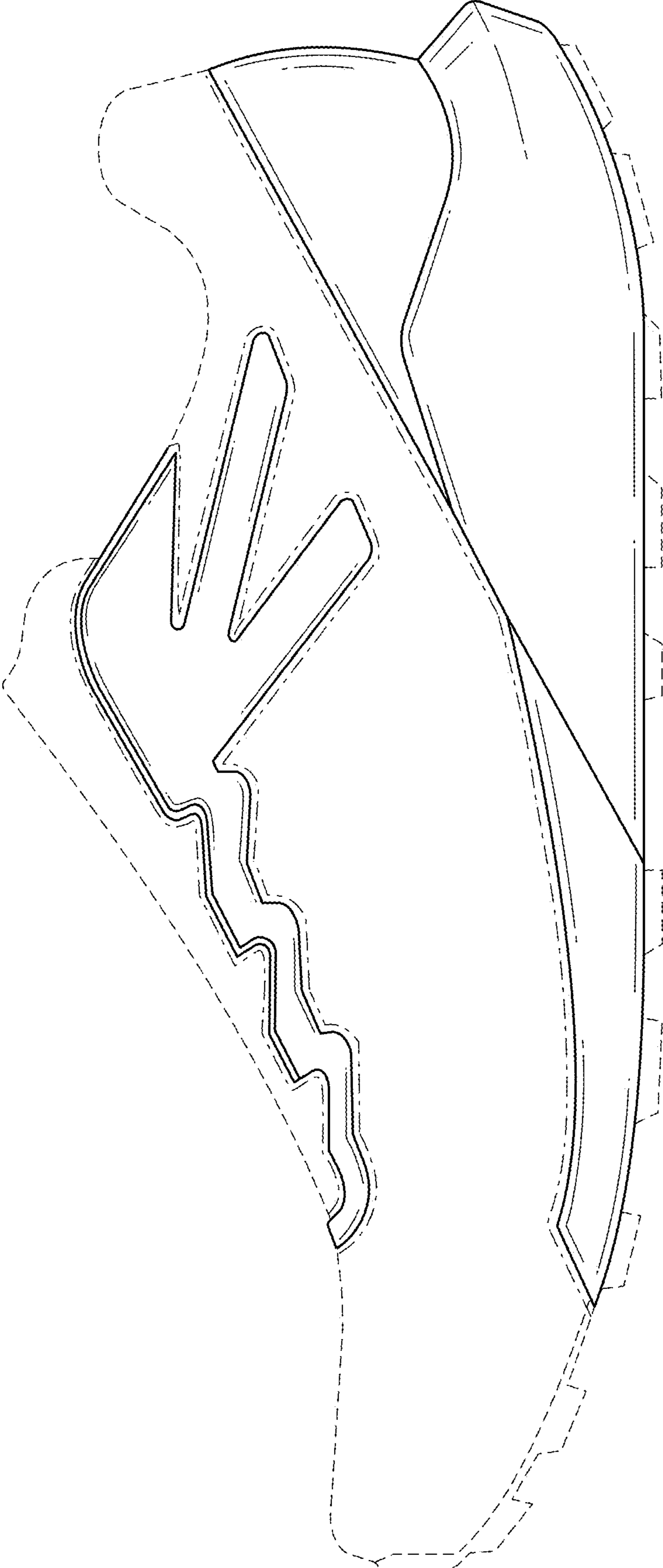

FIG. 3

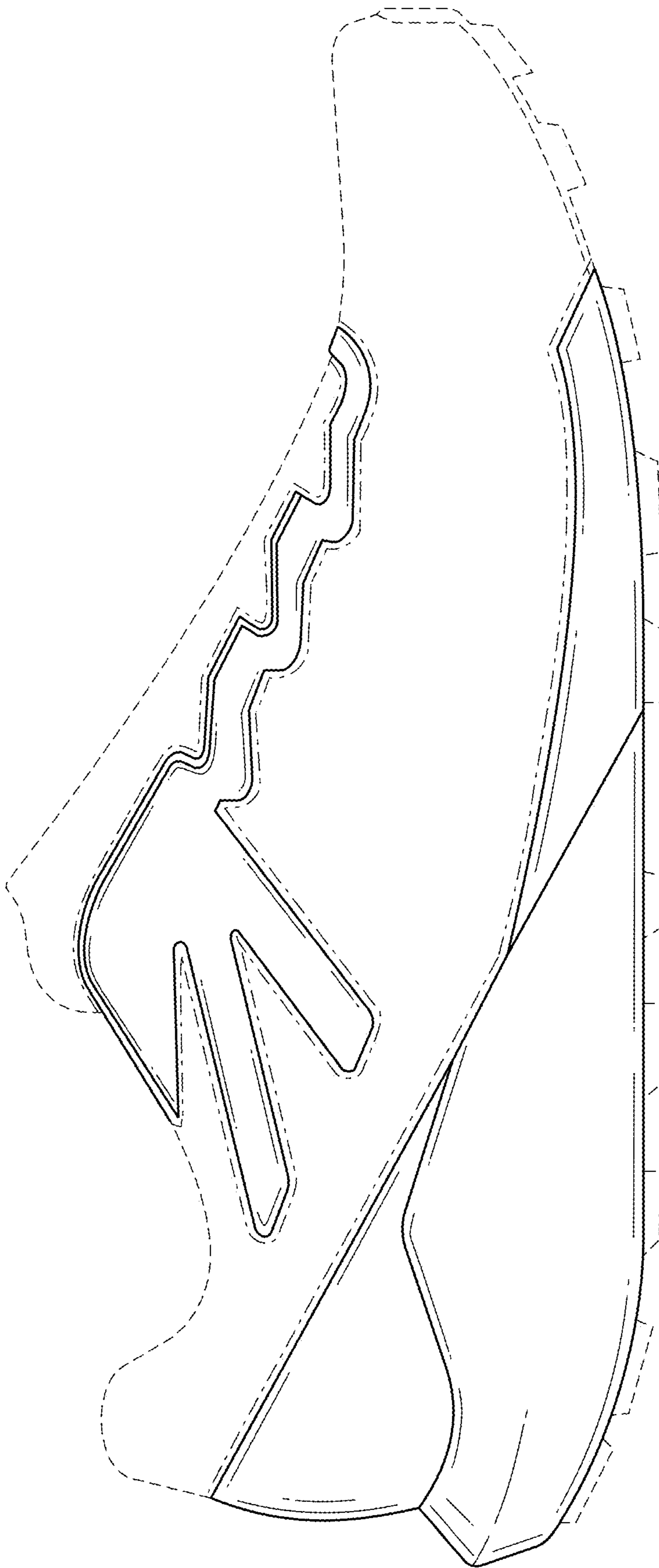

FIG. 4

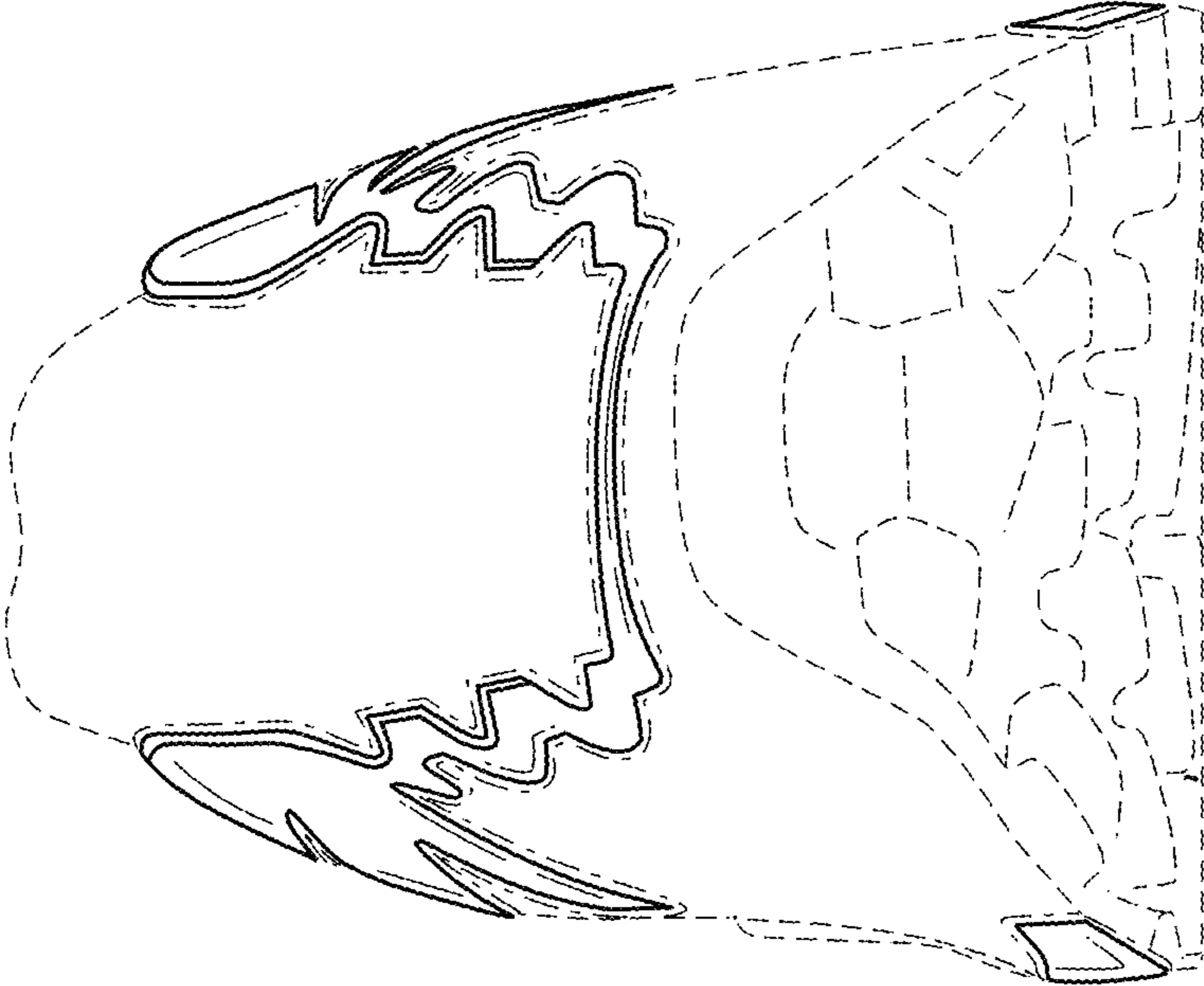

FIG. 5

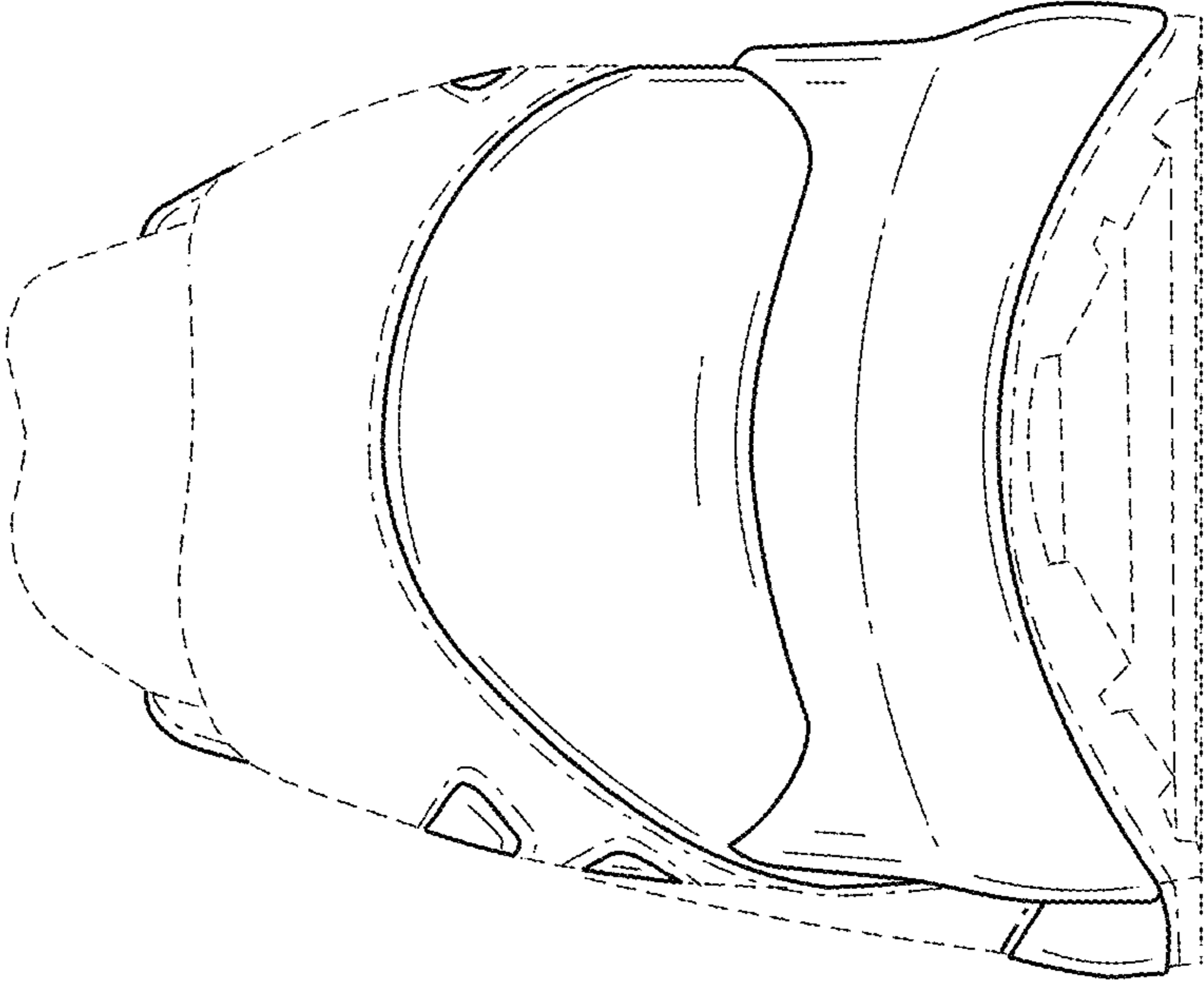

FIG. 6

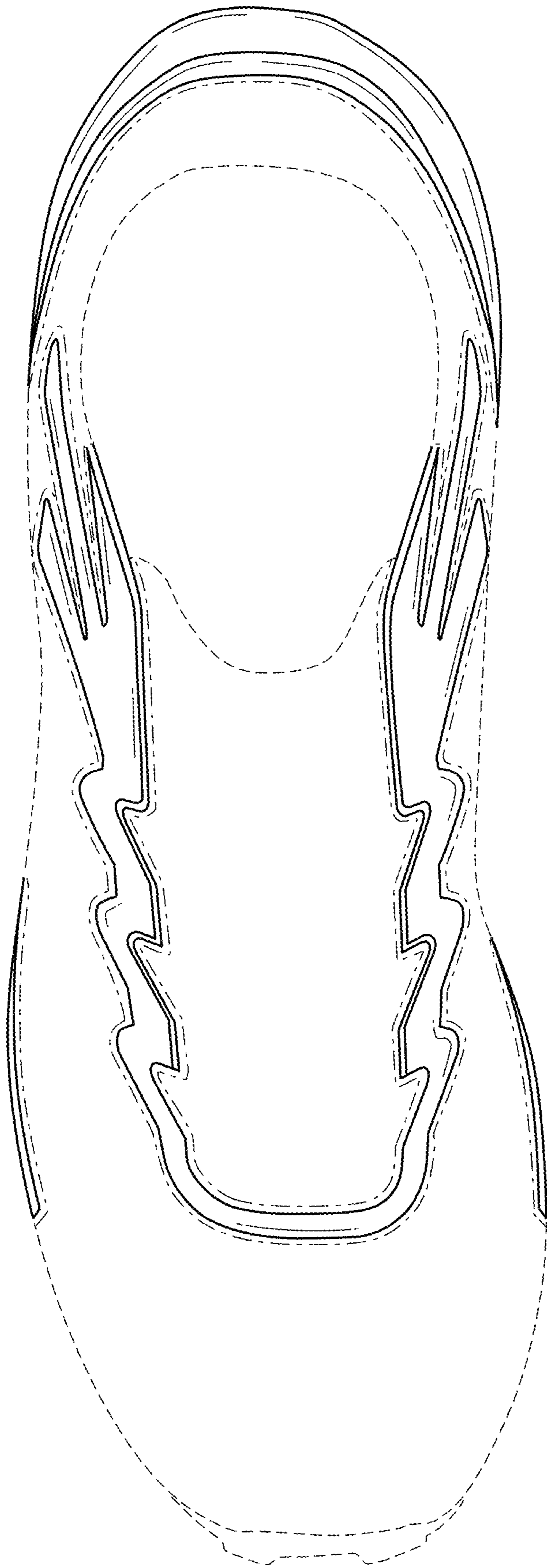

FIG. 7