



US00D933938S

(12) **United States Design Patent** (10) **Patent No.:** **US D933,938 S**  
**Bolon** (45) **Date of Patent:** **\*\* Oct. 26, 2021**

(54) **GARMENT**

(71) Applicant: **David D. Bolon**, Columbus, OH (US)

(72) Inventor: **David D. Bolon**, Columbus, OH (US)

(\*\*) Term: **15 Years**

(21) Appl. No.: **29/735,607**

(22) Filed: **May 22, 2020**

(51) **LOC (13) Cl.** ..... **02-02**

(52) **U.S. Cl.**  
USPC ..... **D2/823**

(58) **Field of Classification Search**  
USPC ..... D2/500, 501, 502, 740, 757, 775, 796,  
D2/823, 824, 826, 827, 860, 861, 862,  
D2/863, 864  
CPC ..... A41D 1/215; A41D 23/00; A41D 15/00;  
A41D 15/04; A47G 9/068  
See application file for complete search history.

(56) **References Cited**

**U.S. PATENT DOCUMENTS**

59,227 A \* 10/1866 Isaacsohn et al. .... A41D 5/006  
2/65  
885,872 A \* 4/1908 Scott ..... A41D 23/00  
2/91  
D543,010 S \* 5/2007 Erickson ..... A41D 23/00  
D2/823

(Continued)

**OTHER PUBLICATIONS**

Cozy Fleece Wrap Shawl with Large Front Pockets, announced Sep. 8, 2014 [online]. [Site visited May 6, 2021]. Available from internet, URL: <<https://www.amazon.com/Fleece-Shawl-Large-Front-Pockets/dp/B07GX8P553>> (Year: 2014).\*

(Continued)

*Primary Examiner* — Kevin K Rudzinski

*Assistant Examiner* — Amber J Rabie

(74) *Attorney, Agent, or Firm* — Jason H. Foster;  
Kremblas & Foster

(57) **CLAIM**

The ornamental design for a garment substantially, as shown and described.

**DESCRIPTION**

FIG. 1 is a front perspective view of a garment showing my new design being worn by a user with arms inside the garment;  
FIG. 2 is a front view thereof as it is to be worn by the user;  
FIG. 3 is a rear view thereof as it is to be worn by the user;  
FIG. 4 is a right side view thereof as it is to be worn by the user;  
FIG. 5 is a left side view thereof as it is to be worn by the user;  
FIG. 6 is a top plan view thereof as it is to be worn by the user;  
FIG. 7 is a front perspective view of a garment showing my new design being worn by a user with arms outside the garment;  
FIG. 8 is a front view thereof showing my new design being worn by a user with arms outside the garment;  
FIG. 9 is a rear view thereof showing my new design being worn by a user with arms outside the garment;  
FIG. 10 is a right side view thereof showing my new design being worn by a user with arms outside the garment;  
FIG. 11 is a left side view thereof showing my new design being worn by a user with arms outside the garment;  
FIG. 12 is a top plan view thereof; and,  
FIG. 13 is a top plan view of the garment lying flat.  
The broken lines illustrating a human figure in the drawings represent environment and form no part of the claimed design.

**1 Claim, 9 Drawing Sheets**

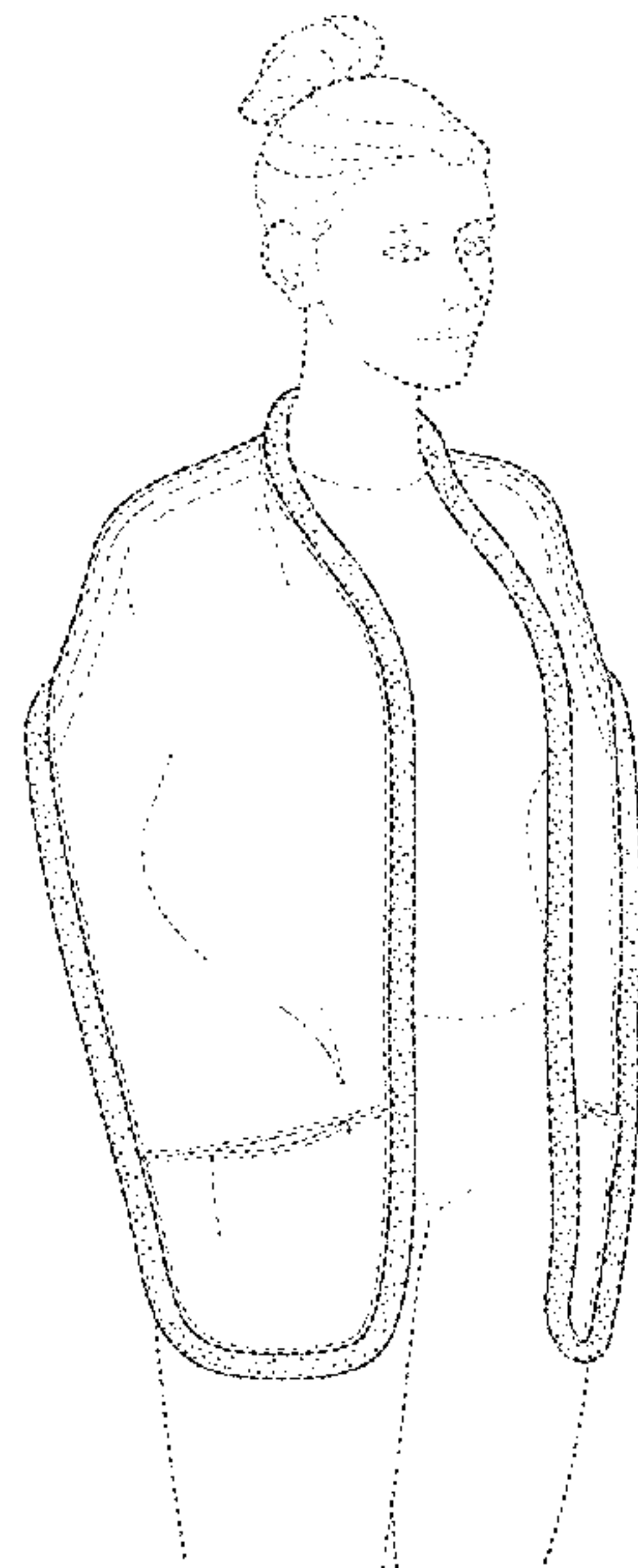

(56)

References Cited

U.S. PATENT DOCUMENTS

D630,820 S \* 1/2011 Wilson ..... D2/826  
 D637,796 S \* 5/2011 Callahan ..... A41D 23/00  
 D694,989 S \* 12/2013 Kelly ..... A41D 23/00  
 D695,490 S \* 12/2013 Lake ..... A41D 5/006  
 D735,446 S 8/2015 Daws  
 D747,848 S 1/2016 Sanders  
 D750,867 S \* 3/2016 Lake ..... A42B 1/048  
 D766,547 S 9/2016 Snodgrass  
 D818,245 S 5/2018 Richardson  
 D833,114 S 11/2018 Dickson  
 D837,488 S 1/2019 Noto et al.  
 D848,707 S 5/2019 Stoldt  
 D850,760 S 6/2019 Greenblat et al.  
 D855,934 S 8/2019 Duerr  
 D856,633 S 8/2019 Morrison  
 D862,845 S 10/2019 Plant et al.  
 D863,731 S 10/2019 Jones  
 D871,722 S 1/2020 Richardson  
 D873,536 S 1/2020 Manos-Gully et al.  
 D874,073 S 1/2020 Bourne  
 D874,094 S 2/2020 Carey et al.

D877,461 S 3/2020 Mieszczak  
 D877,462 S 3/2020 Teat et al.  
 2005/0039242 A1\* 2/2005 Edmondson ..... A42B 1/241  
 2011/0004971 A1\* 1/2011 Benderradji ..... A42B 1/048  
 2011/0197340 A1\* 8/2011 Kummerfeldt ..... A41D 23/00  
 2013/0227761 A1\* 9/2013 Hoskins ..... A41D 23/00  
 2014/0259334 A1\* 9/2014 Mitchell ..... A41D 23/00  
 2016/0255887 A1\* 9/2016 Scarione ..... A41D 23/00  
 2017/0164663 A1\* 6/2017 Korenek ..... B60N 2/80

OTHER PUBLICATIONS

Women's Fleece Pocket Shawl, announced Nov. 4, 2017 [online].  
 [Site visited May 6, 2021]. Available from internet, URL: <<https://www.amazon.com/Womens-Fleece-Pocket-Shawl-Wrap/dp/B01JKEOFOS>> (Year: 2017).\*

Women's Shawl Wrap Warm Scarf, announced Dec. 4, 2019 [online].  
 [Site visited May 6, 2021]. Available from internet, URL: <<https://www.amazon.com/Womens-Shawl-Wrap-Warm-Scarf/dp/B081S9NH8Q>> (Year: 2019).\*

\* cited by examiner

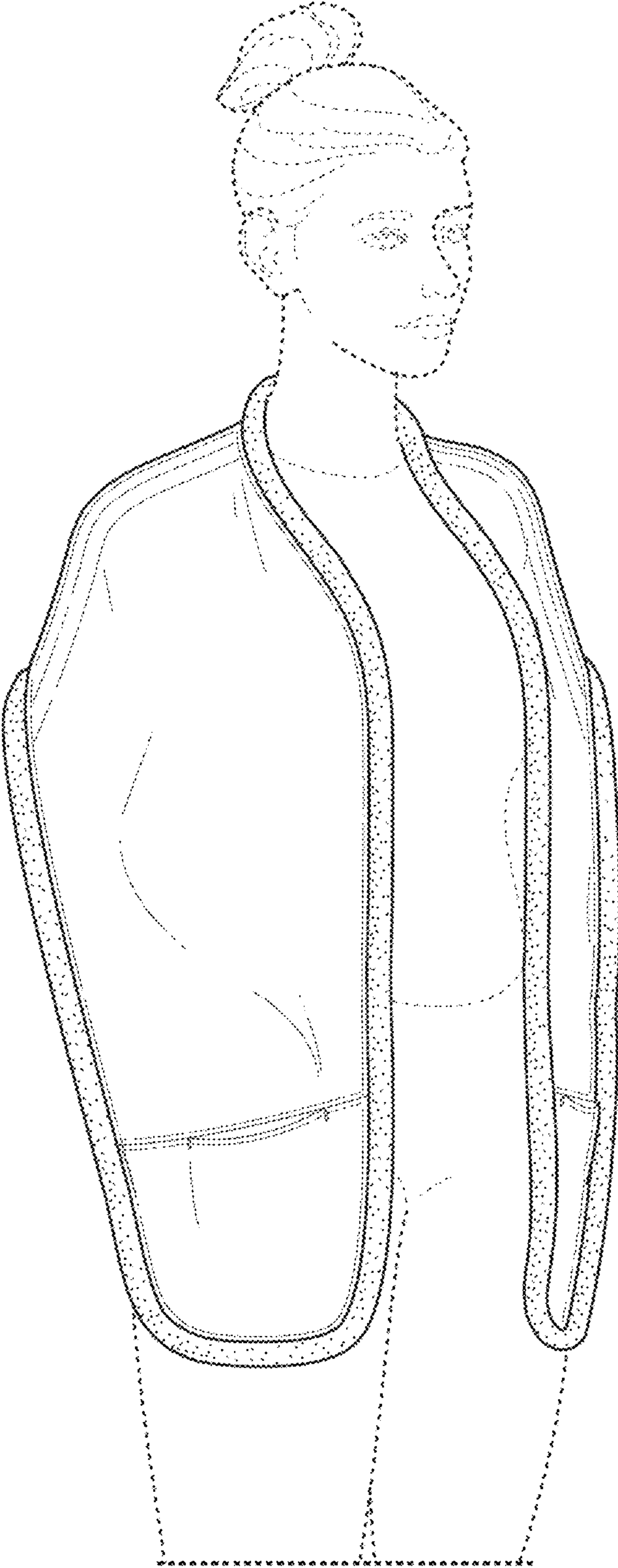

FIG. 1



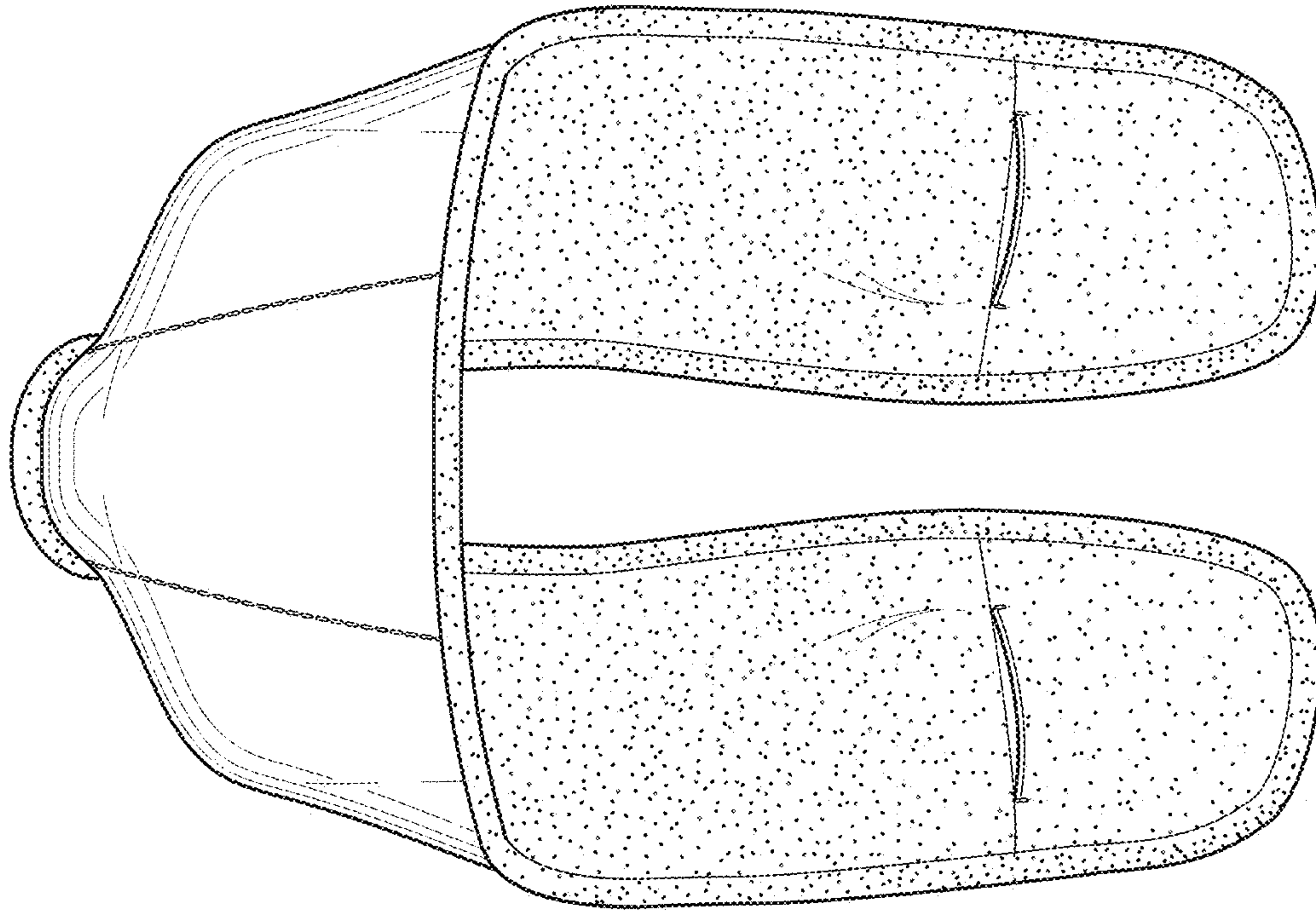

FIG. 2

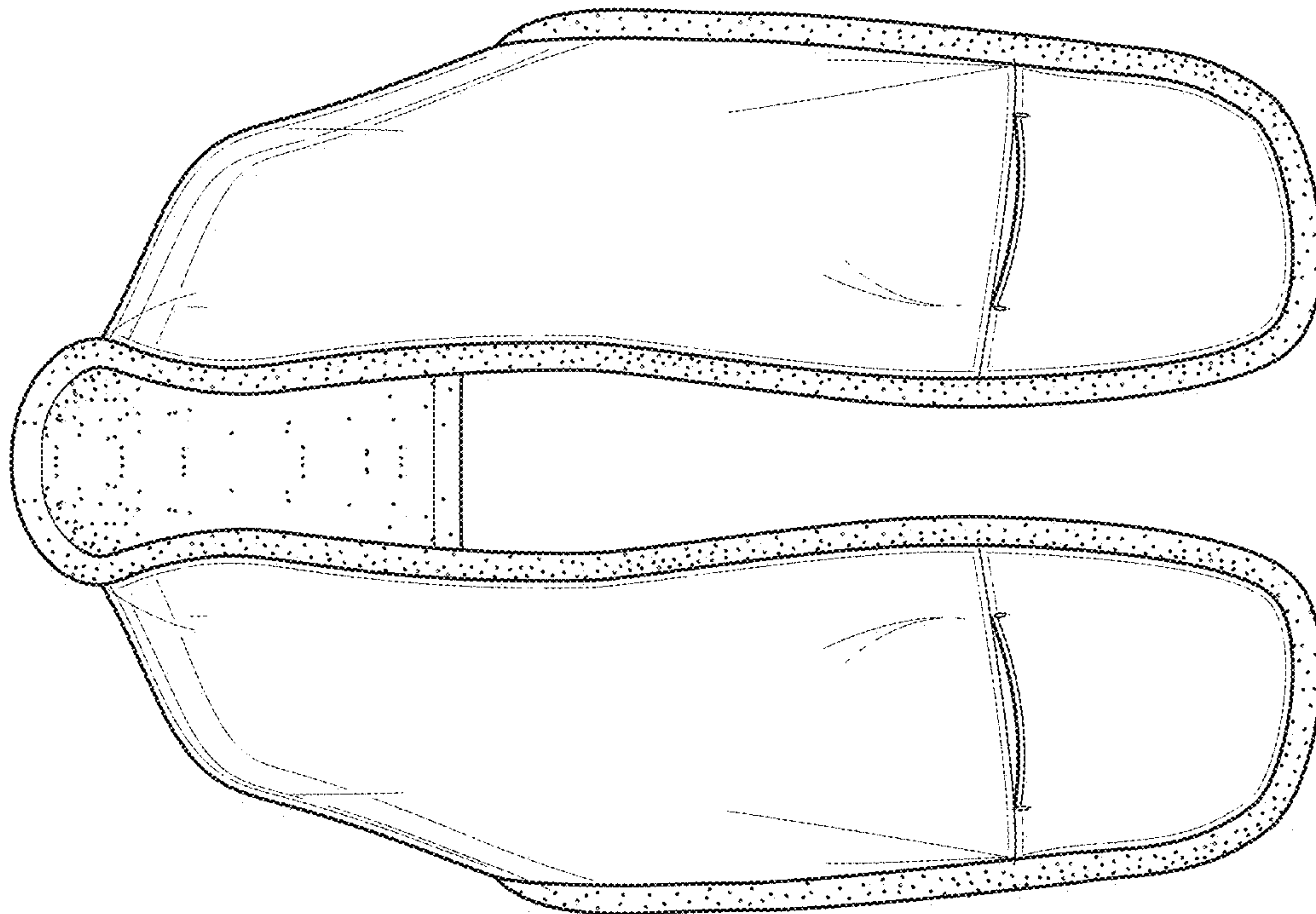

FIG. 3

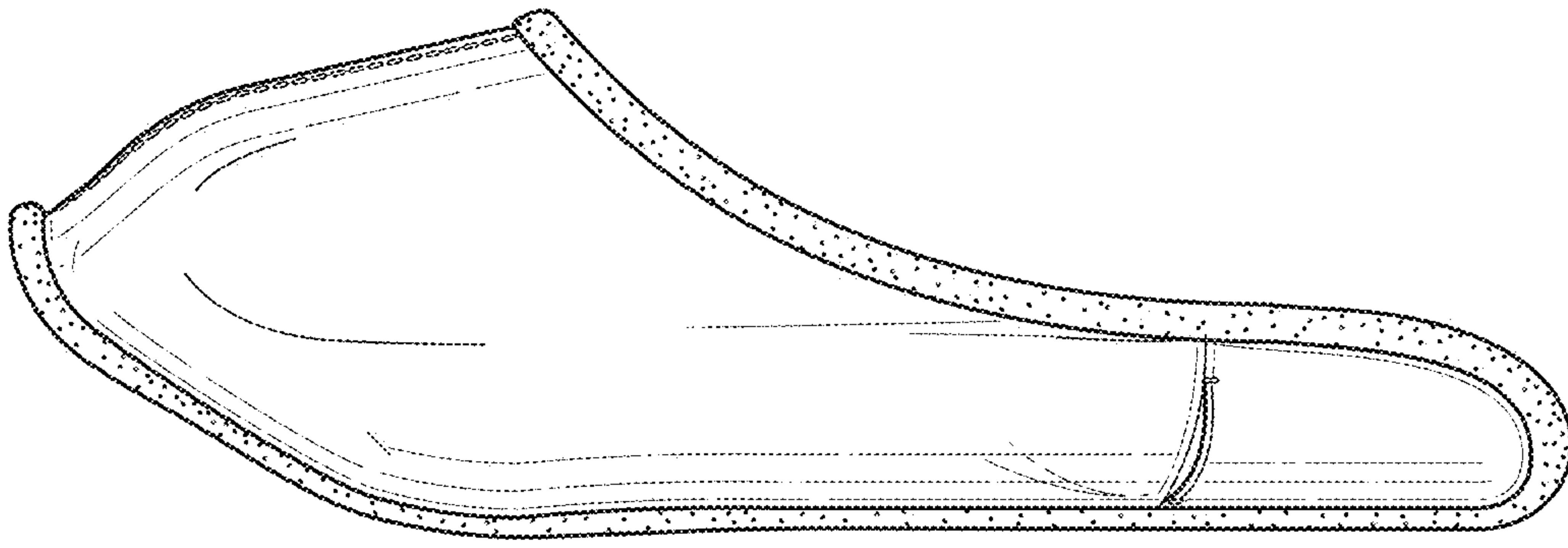

FIG. 5

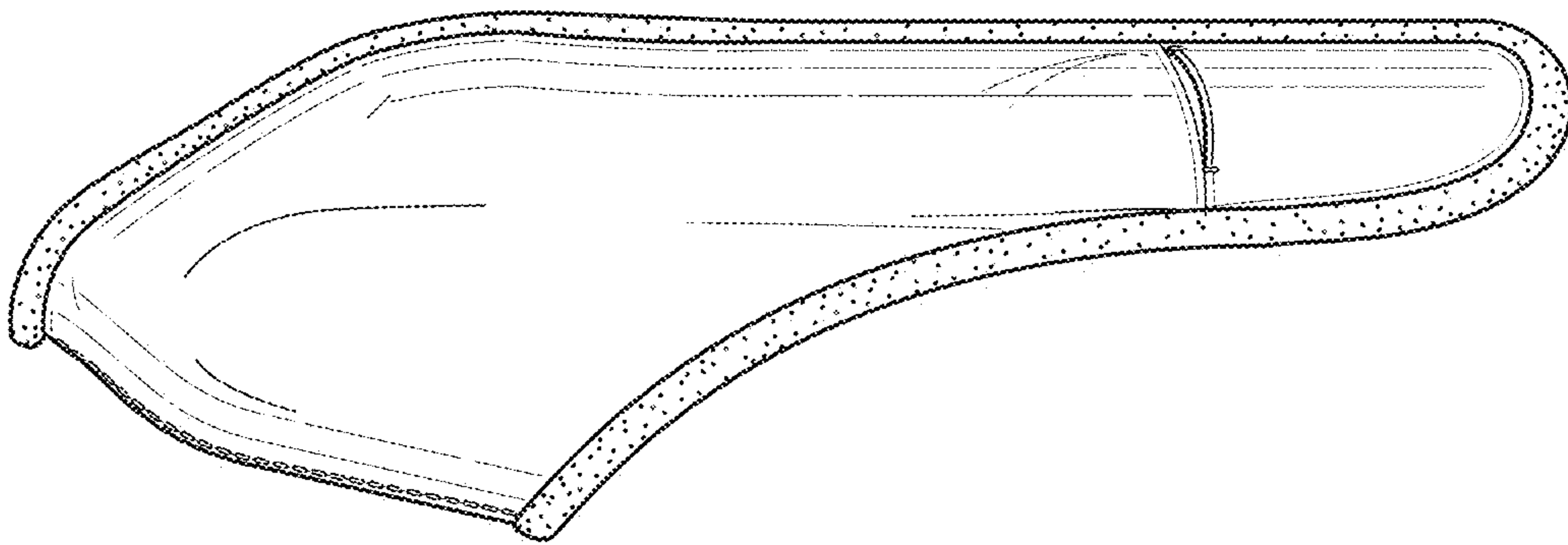

FIG. 4

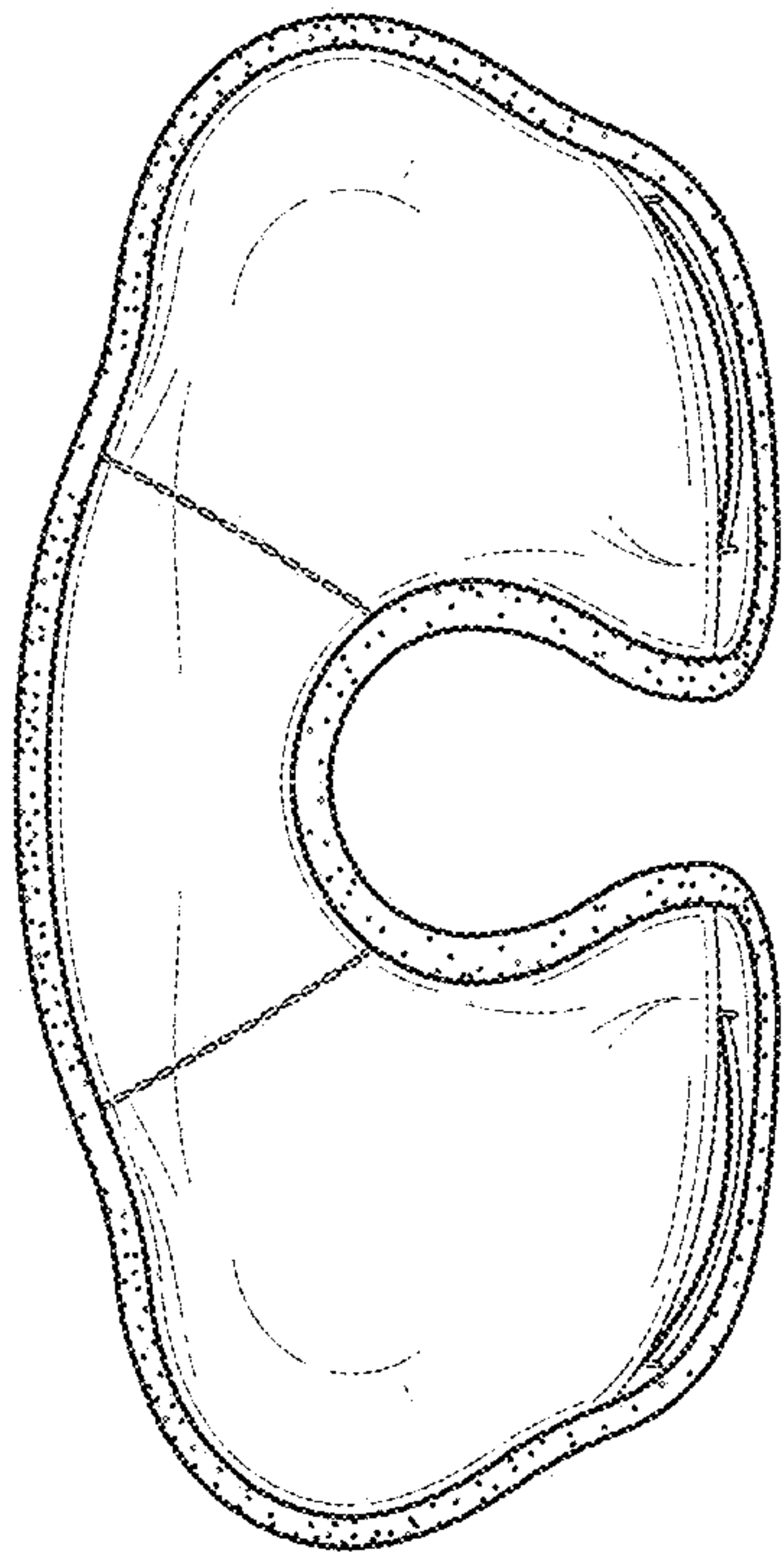

FIG. 6

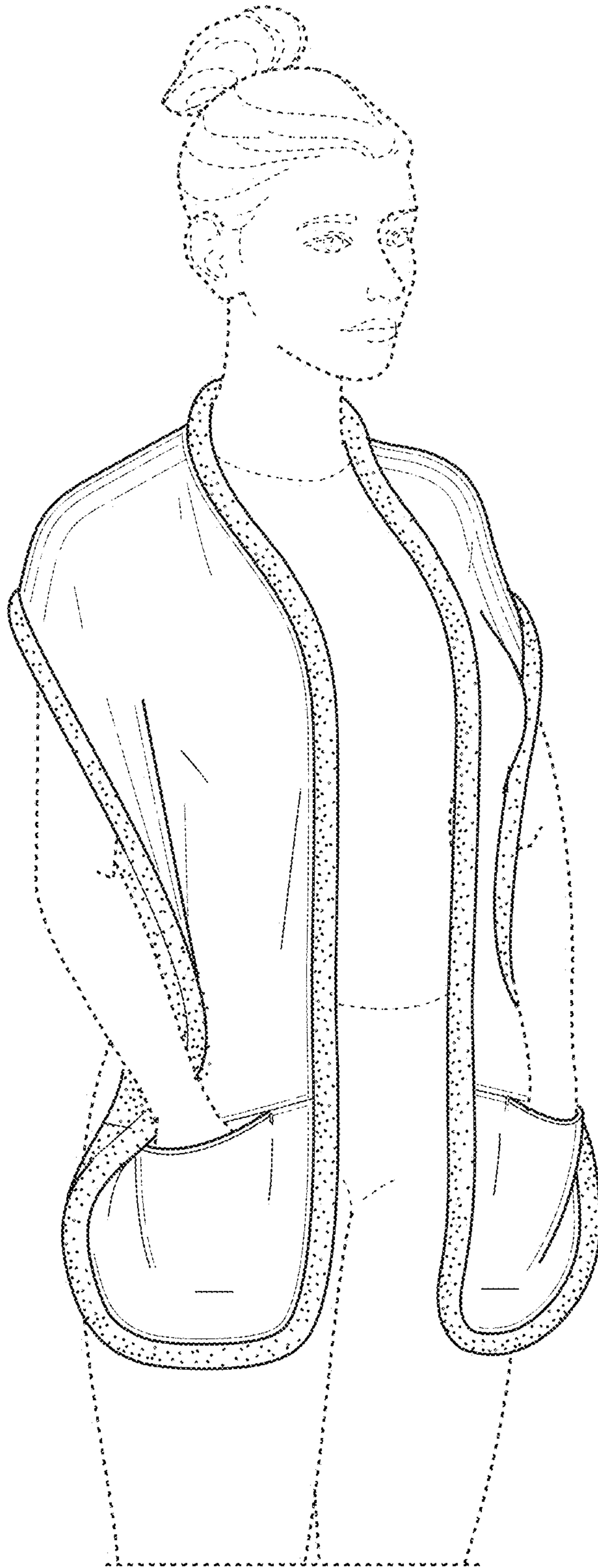

FIG. 7



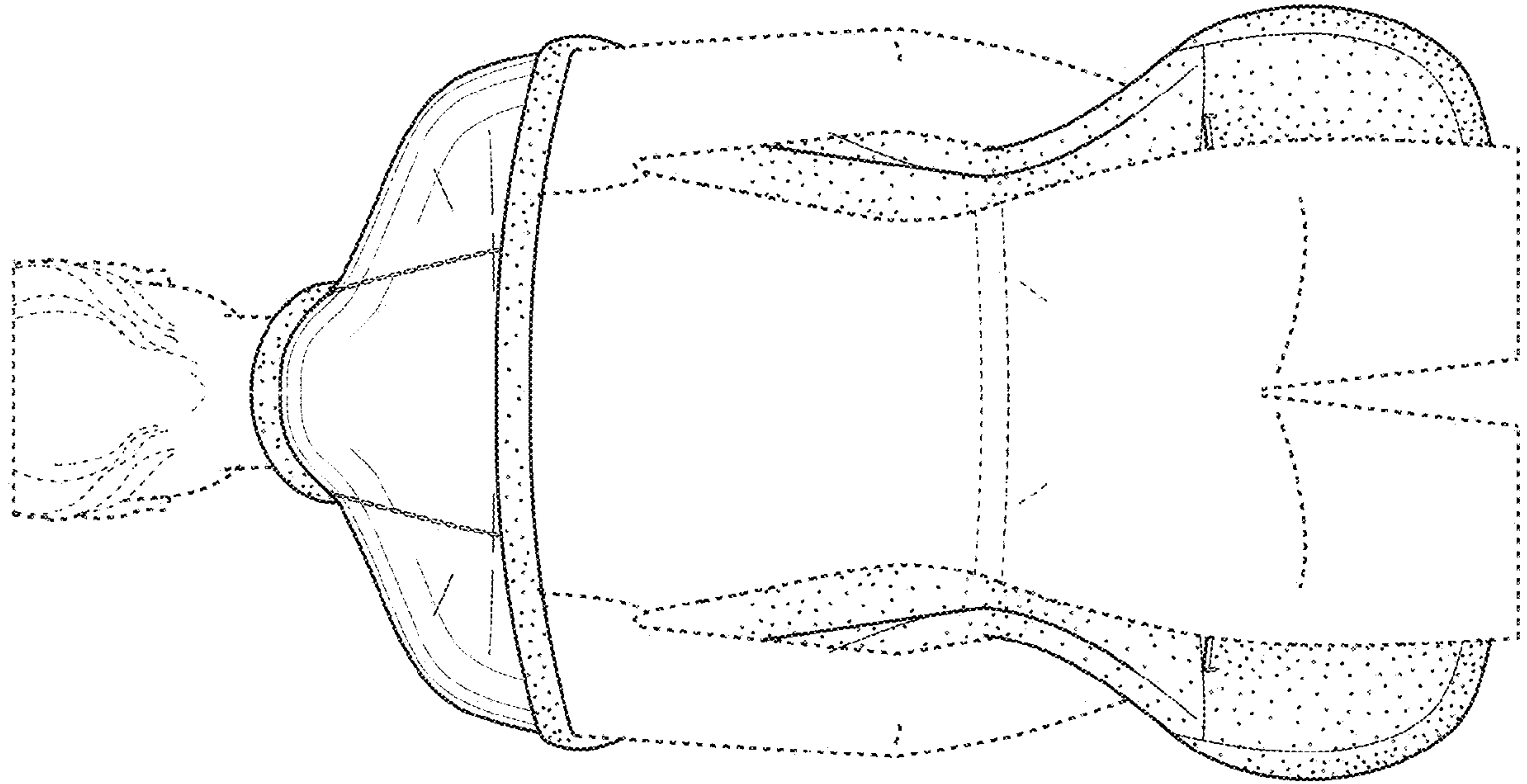

FIG. 9

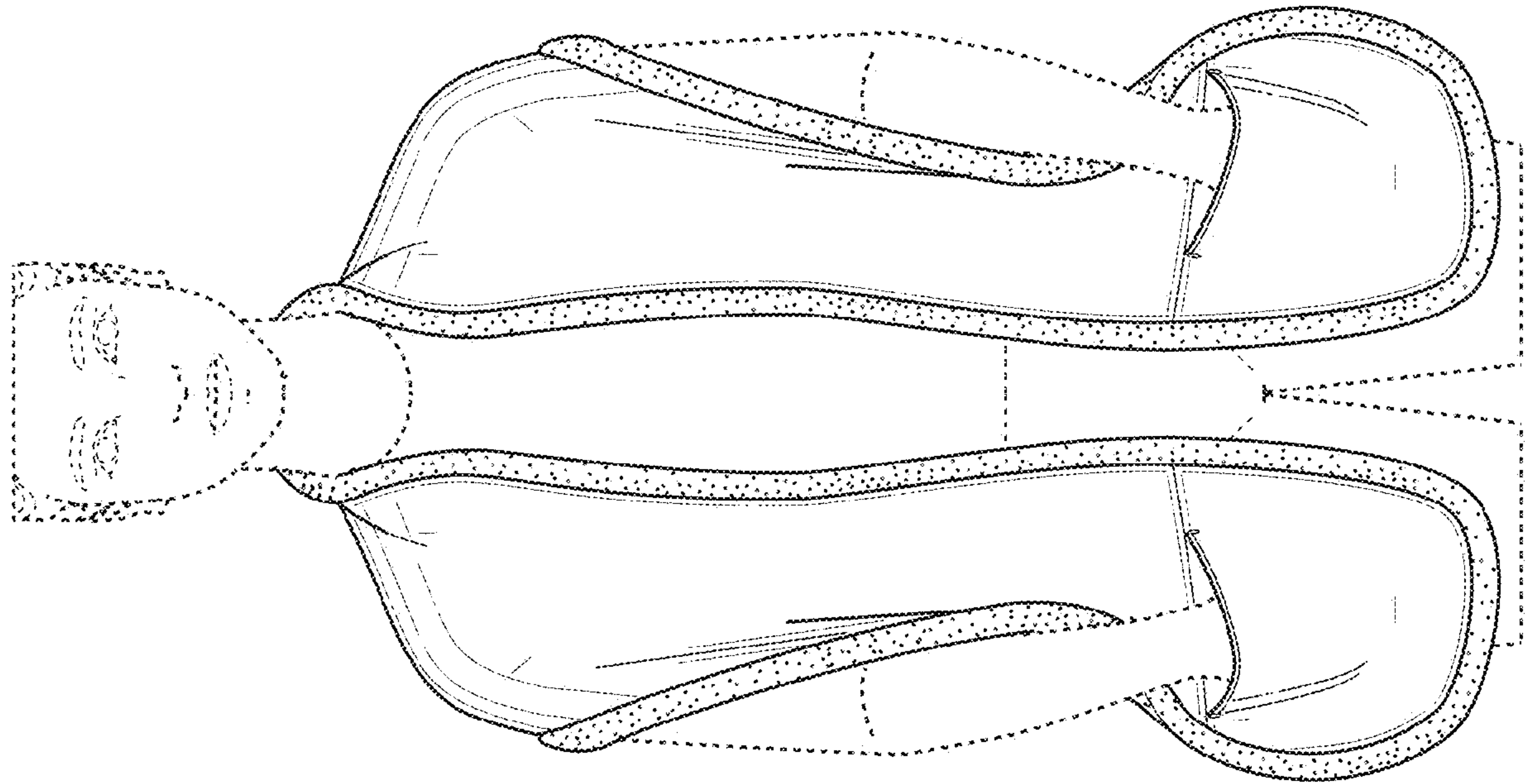

FIG. 8



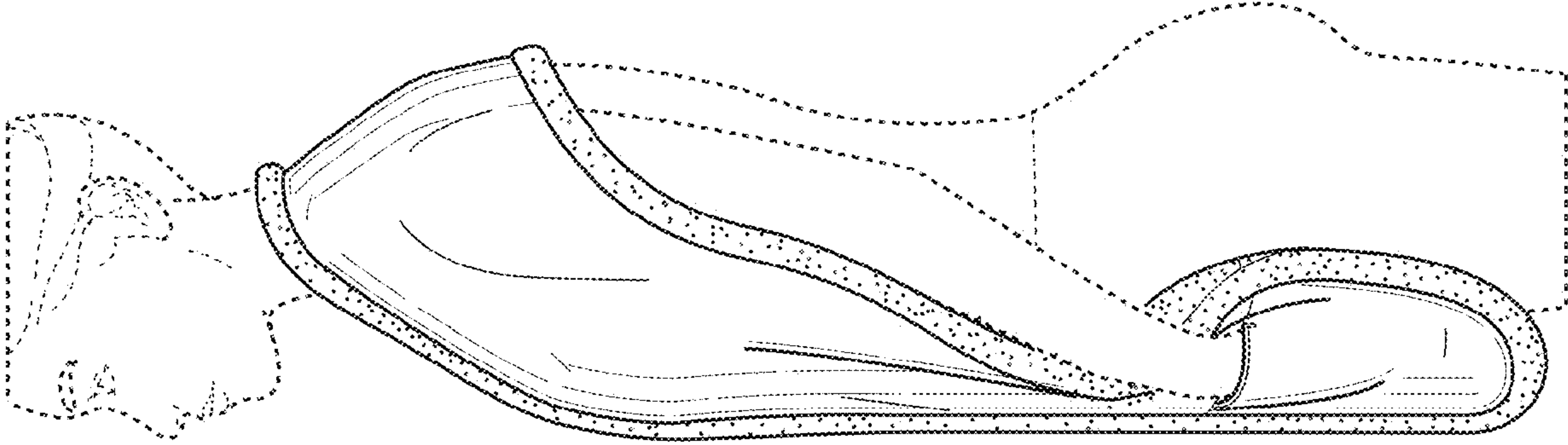

FIG. 11

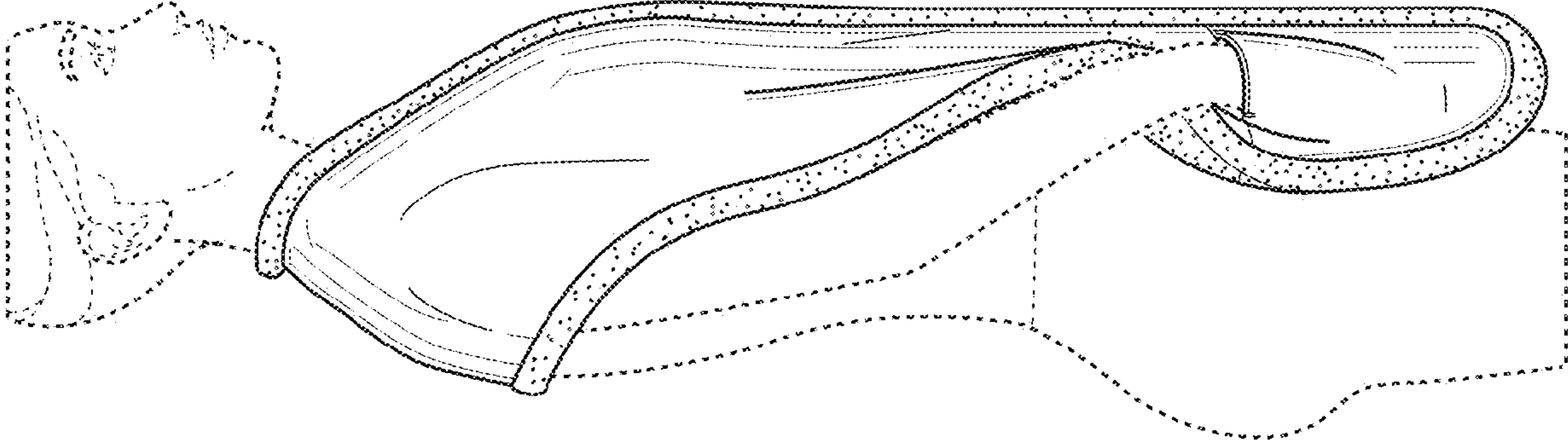

FIG. 10

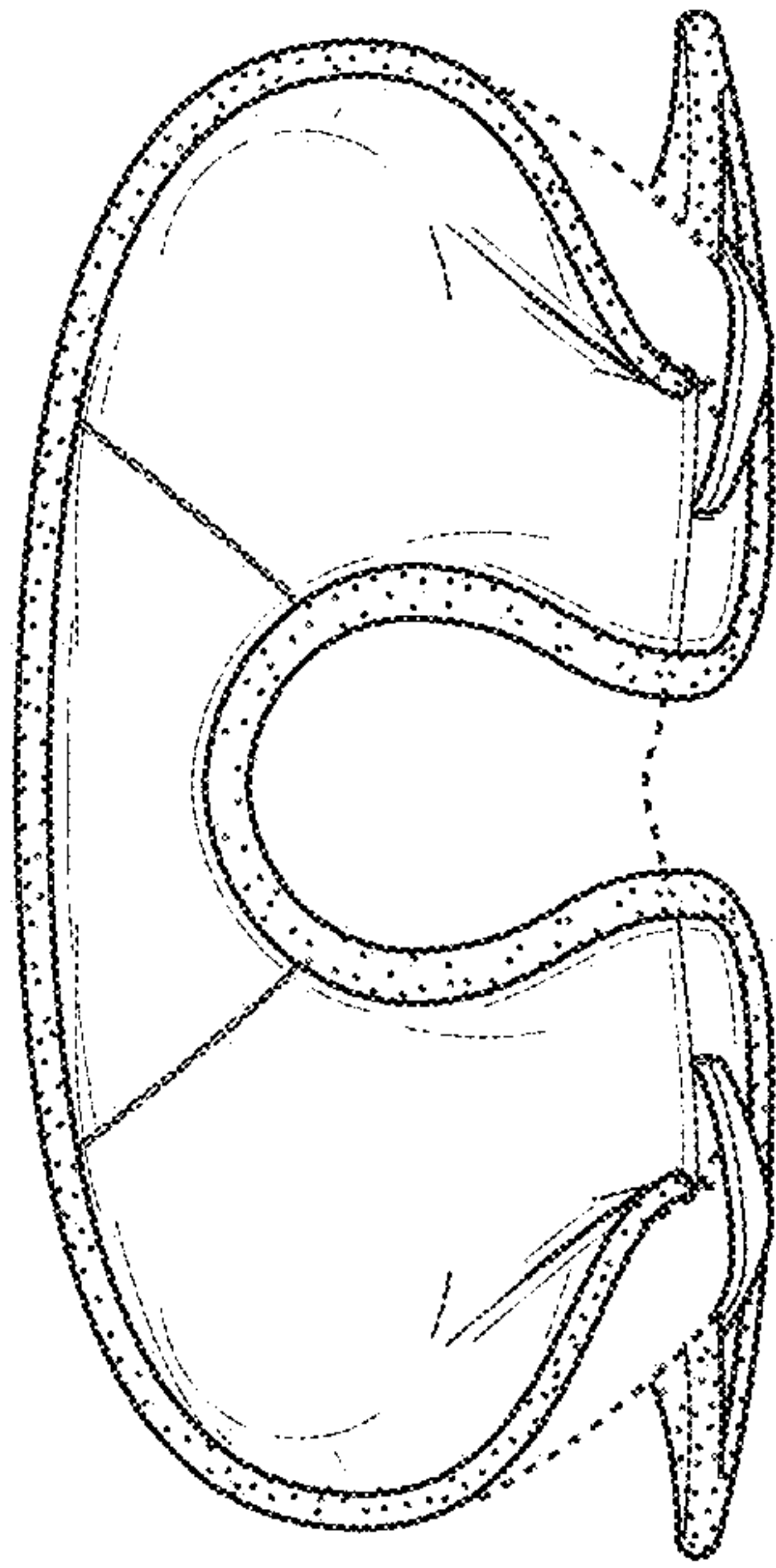

FIG. 12

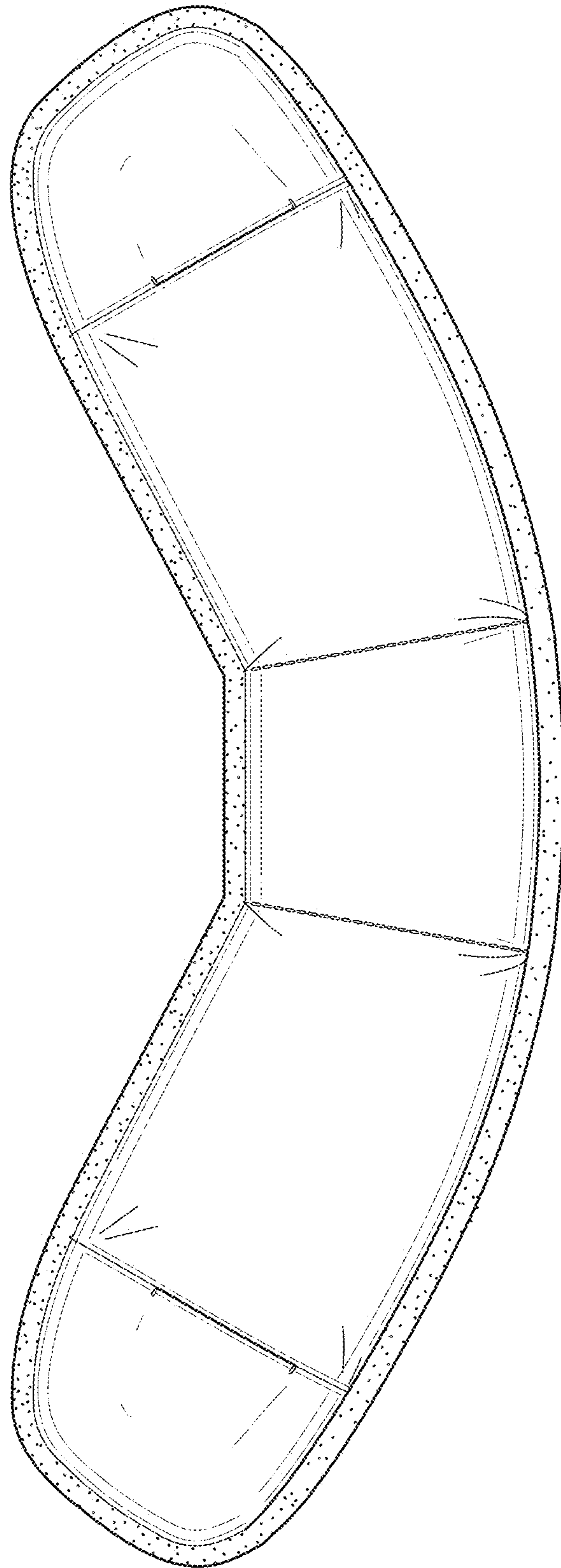

FIG. 13