



US00D933899S

(12) **United States Design Patent** (10) **Patent No.:** **US D933,899 S**
Yang (45) **Date of Patent:** **** Oct. 19, 2021**

(54) **LIPSTICK BOX**

(71) Applicant: **Naijiang Yang**, ShenZhen (CN)

(72) Inventor: **Naijiang Yang**, ShenZhen (CN)

(**) Term: **15 Years**

(21) Appl. No.: **29/705,258**

(22) Filed: **Sep. 10, 2019**

(30) **Foreign Application Priority Data**

Jul. 12, 2019 (CN) 201930371921.2

(51) **LOC (13) Cl.** **28-03**

(52) **U.S. Cl.**
USPC **D28/77; D28/85**

(58) **Field of Classification Search**
USPC D28/4, 64.3, 73, 76, 77, 85-90, 99;
D9/503-504, 500, 529, 574, 575, 686,
D9/723
CPC A45D 33/22; A45D 33/24; A45D 33/28;
A45D 40/00; A45D 40/20; A45D 40/24;
A45D 34/00; A45D 34/04; A45D 34/06;
A45D 34/041; A45D 40/02; A45D 40/06;
A45D 40/18; A45D 40/262; A45D 40/16

See application file for complete search history.

(56) **References Cited**

U.S. PATENT DOCUMENTS

- 1,626,311 A * 4/1927 Tipton A45C 11/008
132/315
- 2,456,948 A * 12/1948 Kaye A45D 40/18
132/316
- 2,458,020 A * 1/1949 Olsen A45D 40/02
132/316
- D156,259 S * 11/1949 Livermore D28/77
(Continued)

OTHER PUBLICATIONS

Kondai Luxury Packaging Twitter, Kondai International Limited, posted on Dec. 4, 2019, retrieved on Apr. 14, 2021, retrieved from

the Internet URL: <https://twitter.com/KondaiLuxury/status/1202417137651871744>.*

Primary Examiner — Jennifer Rivard
Assistant Examiner — Alison M Ofstun

(57) **CLAIM**

The ornamental design for a lipstick box, as shown and described.

DESCRIPTION

FIG. 1 is a rear perspective view of a lipstick box showing my new design;
 FIG. 2 is an exploded view thereof;
 FIG. 3 is a front perspective view of the lipstick box cover thereof, shown separately to show aspects of the design not clearly visible when combined;
 FIG. 4 is a front elevation view of FIG. 3;
 FIG. 5 is a rear elevation view of FIG. 3;
 FIG. 6 is a left side elevation view of FIG. 3;
 FIG. 7 is a right side elevation view of FIG. 3;
 FIG. 8 is a top plan view of FIG. 3;
 FIG. 9 is a bottom plan view of FIG. 3;
 FIG. 10 is a perspective view of the lipstick box base thereof, shown separately to show aspects of the design not clearly visible when combined;
 FIG. 11 is a front elevation view of FIG. 10;
 FIG. 12 is a rear elevation view of FIG. 10;
 FIG. 13 is a left side elevation view of FIG. 10;
 FIG. 14 is a right side elevation view of FIG. 10;
 FIG. 15 is a top plan view of FIG. 10; and,
 FIG. 16 is a bottom plan view of FIG. 10.

The broken lines depict portions of the lipstick box and form no part of the claimed design. The “KONDAI” is a registered trademark in China with a registered number 33733138, the applicant of the trademark is Shenzhen Shi Jin Zheng Jiang Da Metal & Plastic Ware Co. Ltd., the owner is also Shenzhen Shi Jin Zheng Jiang Da Metal & Plastic Ware Co. Ltd.

1 Claim, 16 Drawing Sheets

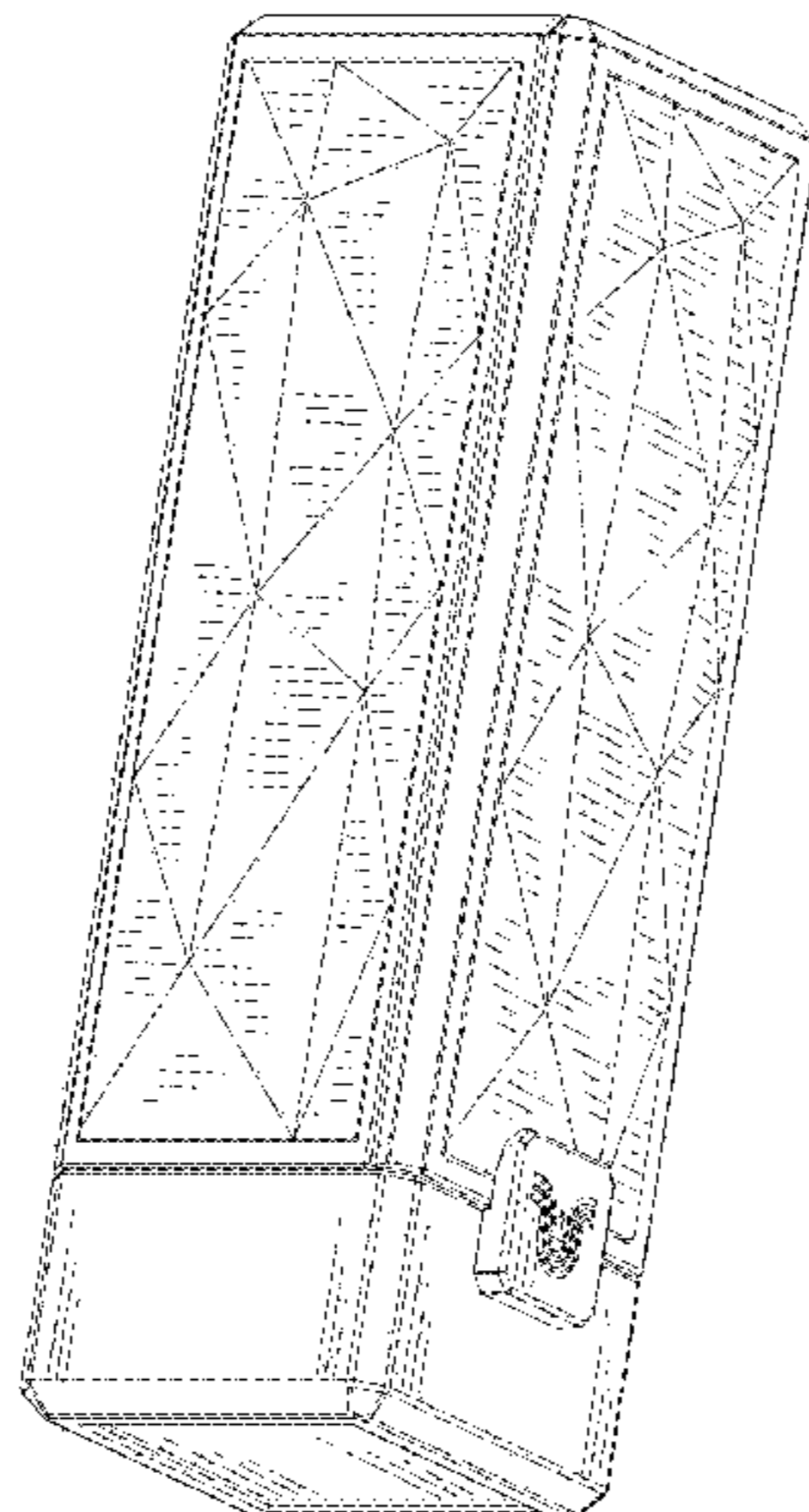

(56)

References Cited

U.S. PATENT DOCUMENTS

2,512,476 A * 6/1950 Birnkrant A45D 40/02
132/316
D243,124 S * 1/1977 Horowitz D28/77
D354,374 S * 1/1995 Battaglia D28/77
5,513,754 A * 5/1996 Chang A45C 11/008
132/296
D467,039 S * 12/2002 Fuller D28/77
D471,324 S * 3/2003 Kalin D28/77
D505,519 S * 5/2005 Korba D28/85
D563,051 S * 2/2008 Martinez D28/85
D567,447 S * 4/2008 Lee D28/85
D740,491 S * 10/2015 Albertini D28/76
2005/0150513 A1 * 7/2005 Taylor A45D 42/02
132/316

* cited by examiner

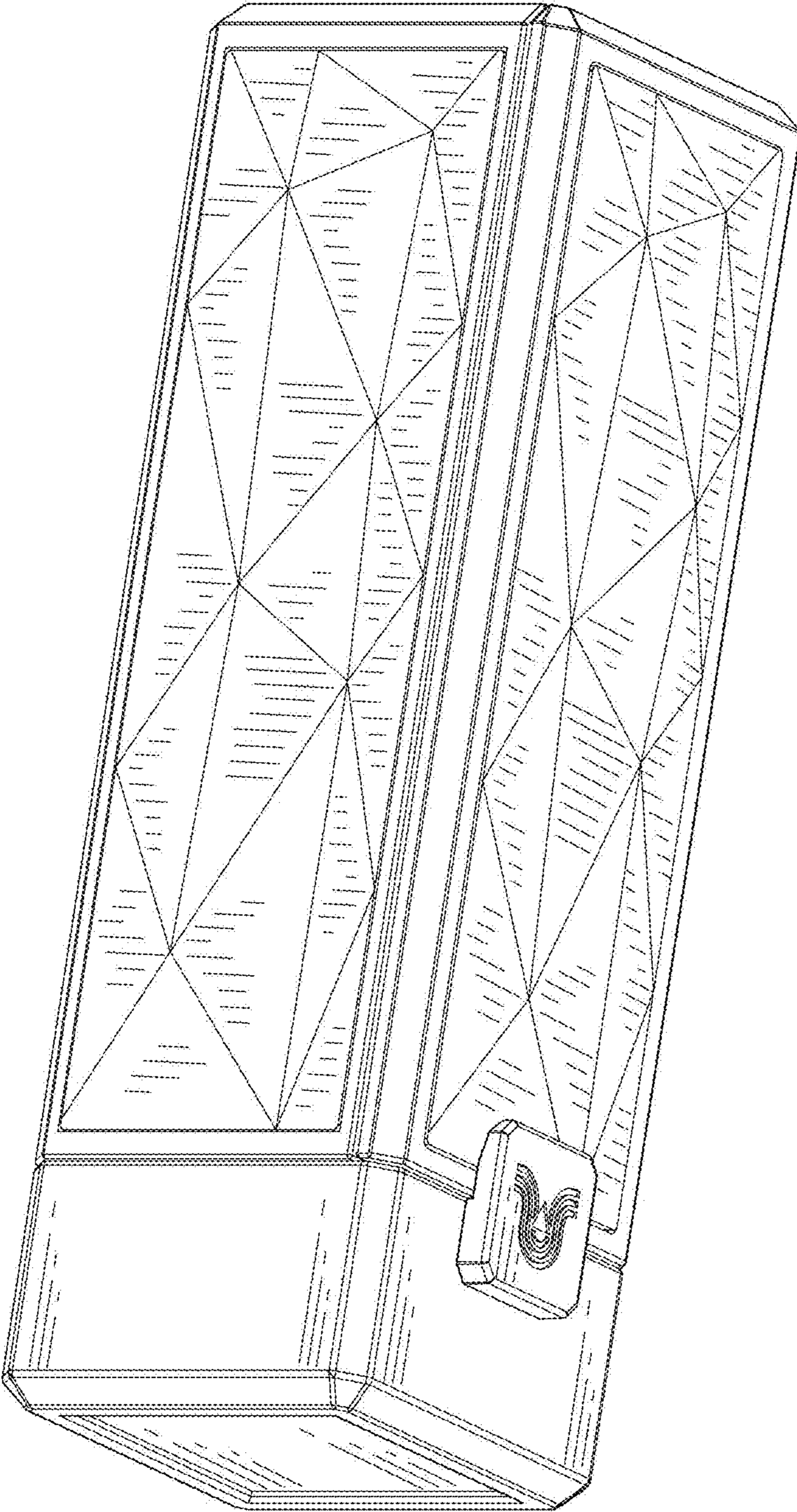

FIG.1

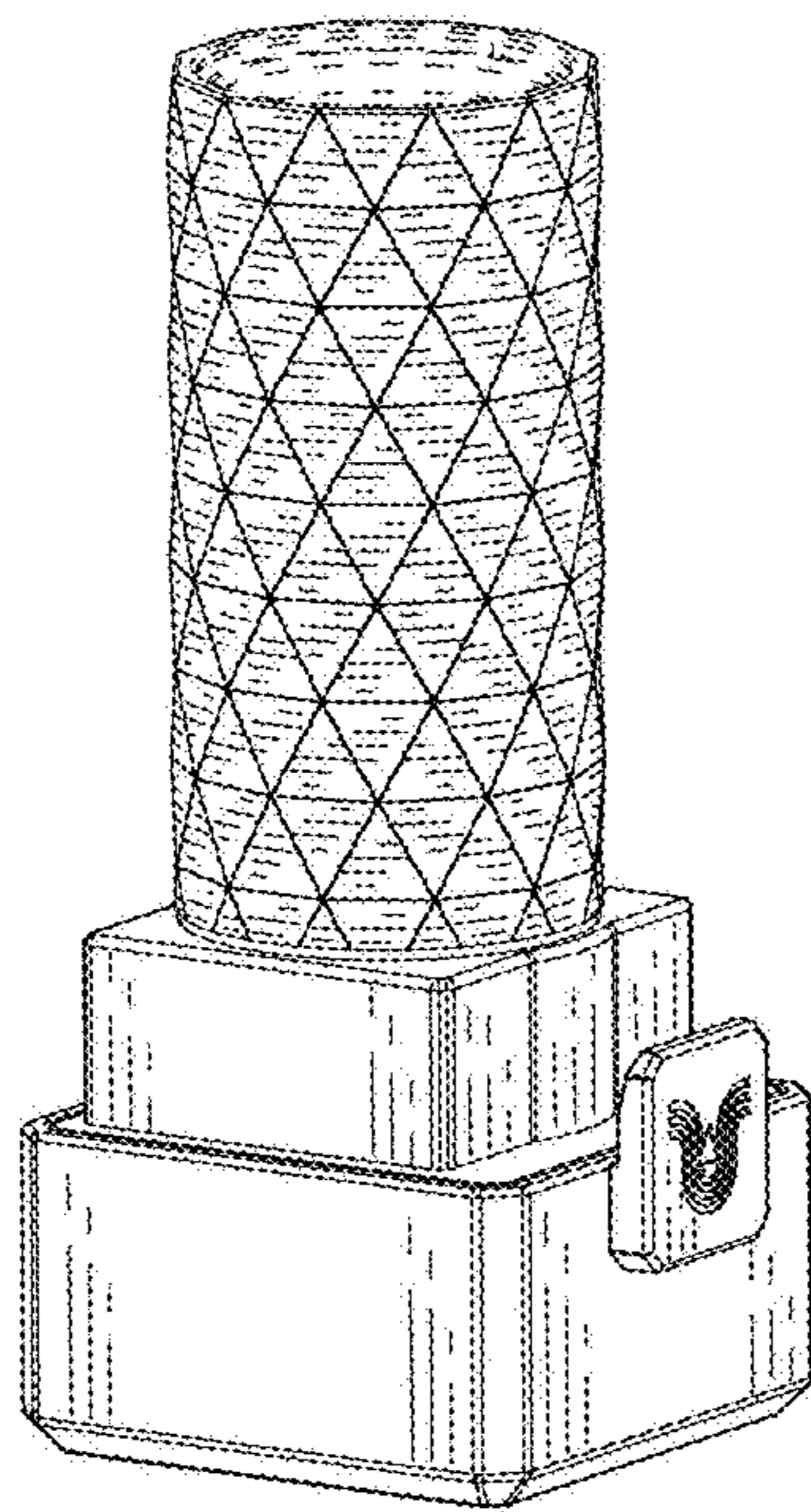
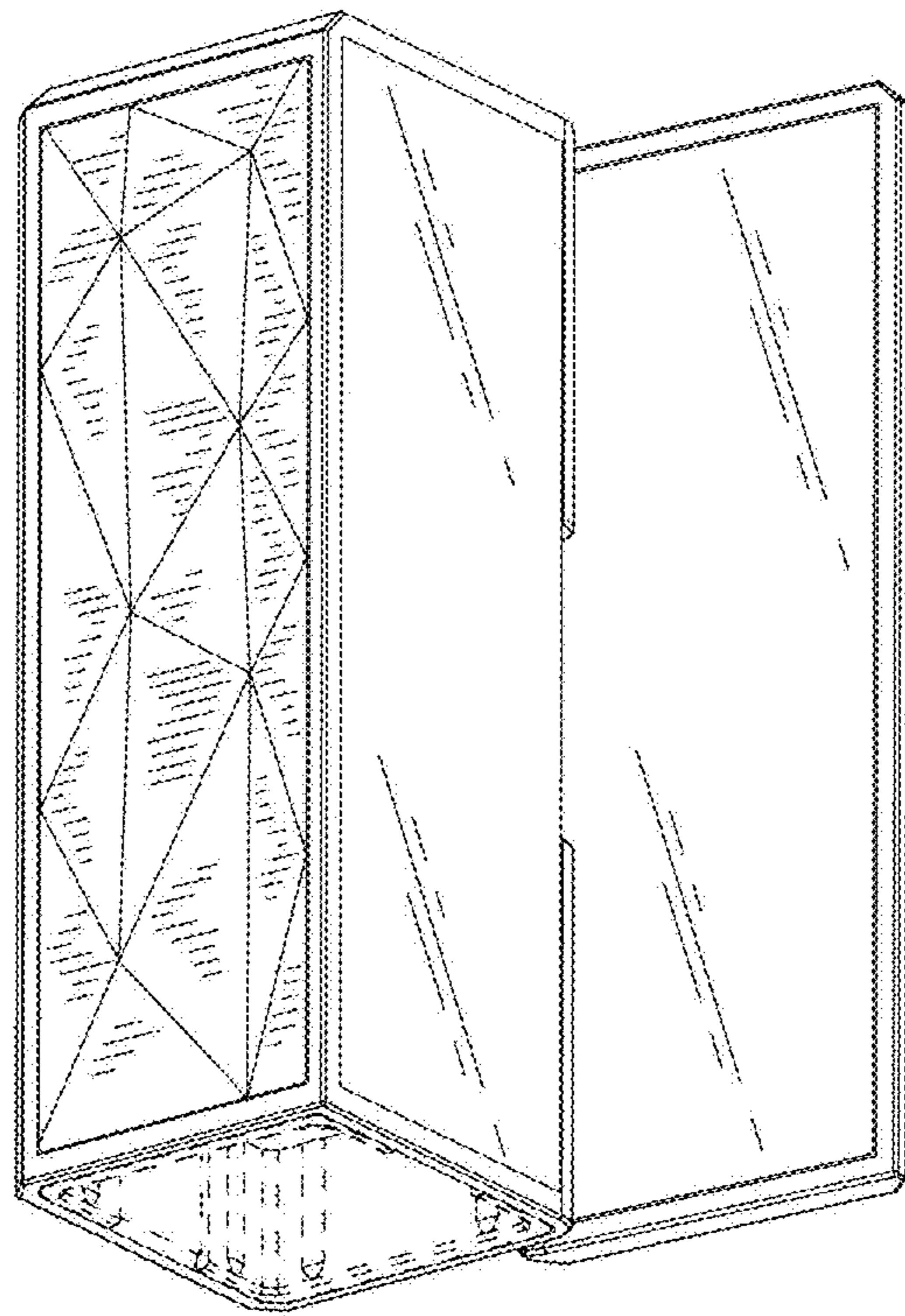

FIG.2

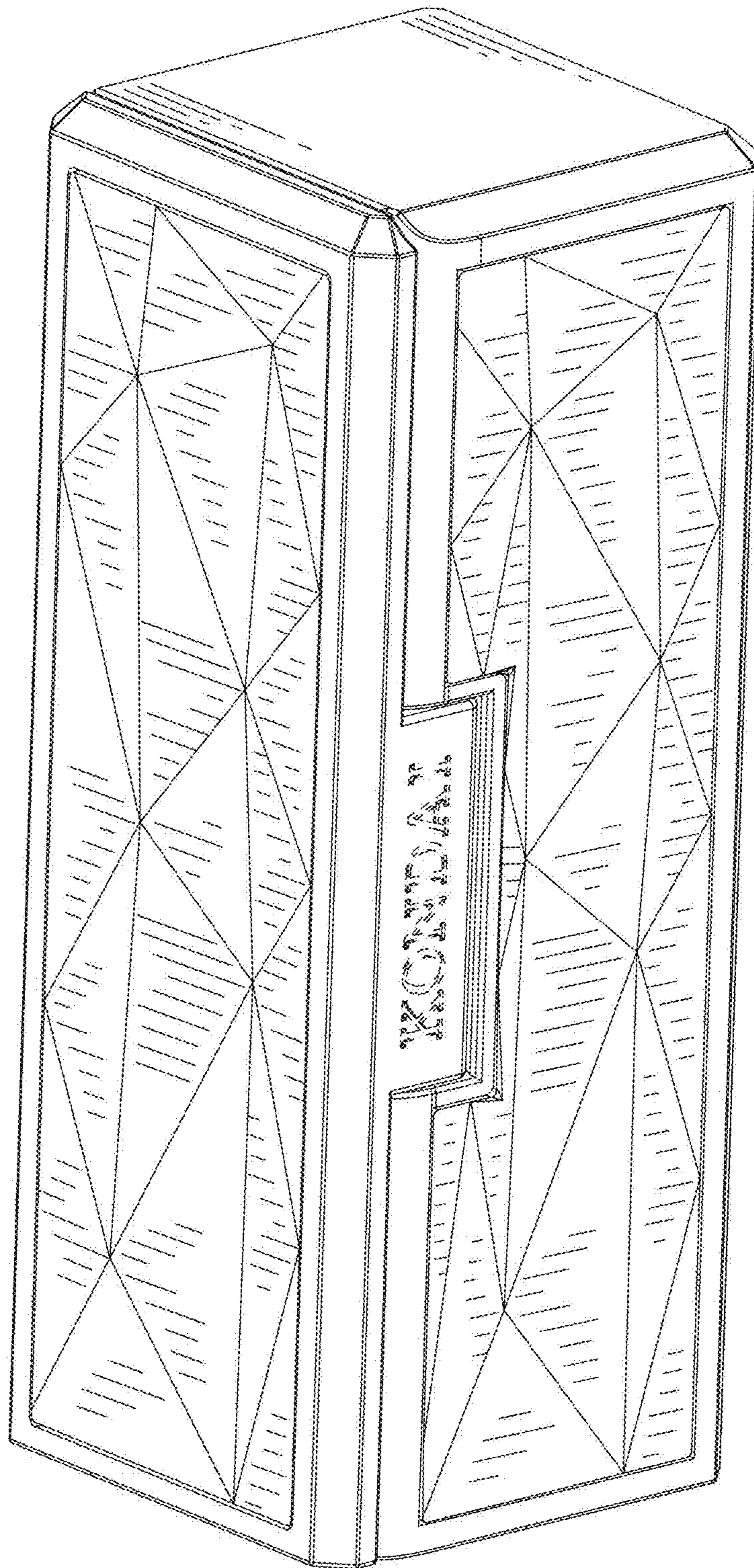

FIG.3

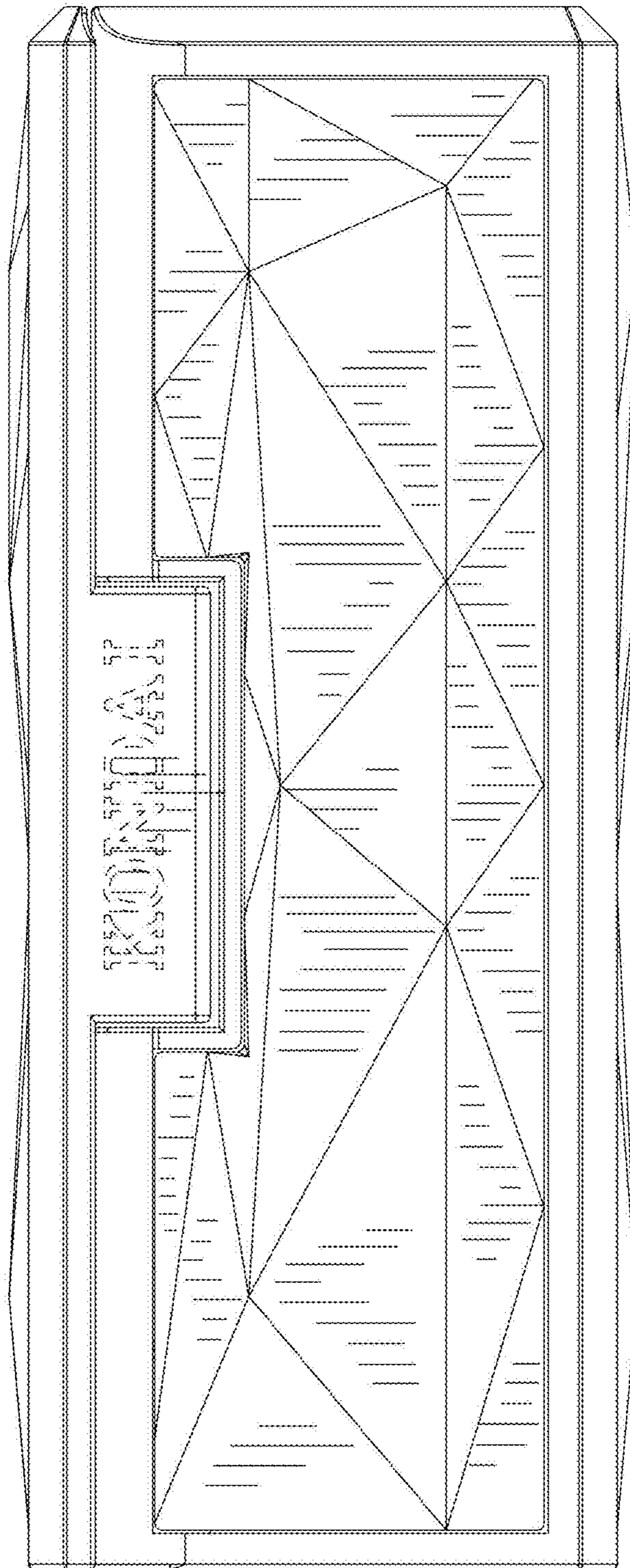

FIG.4

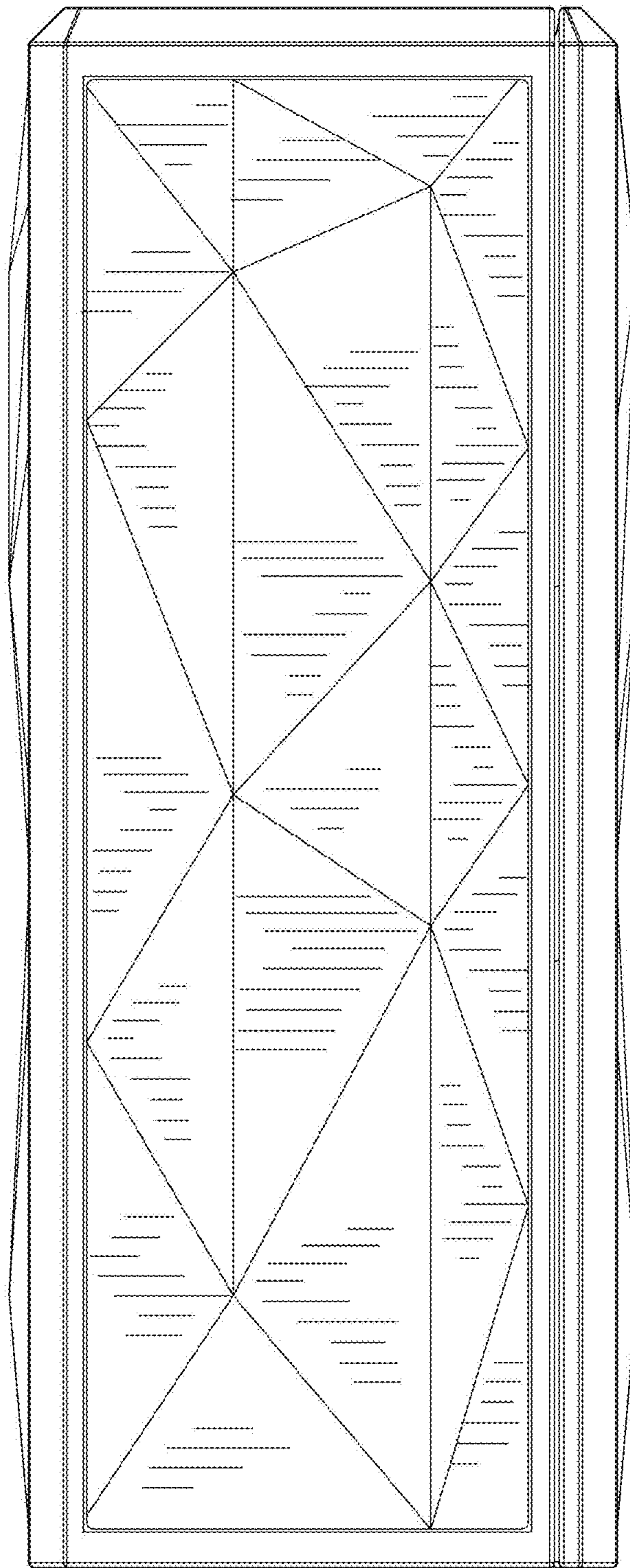

FIG. 5

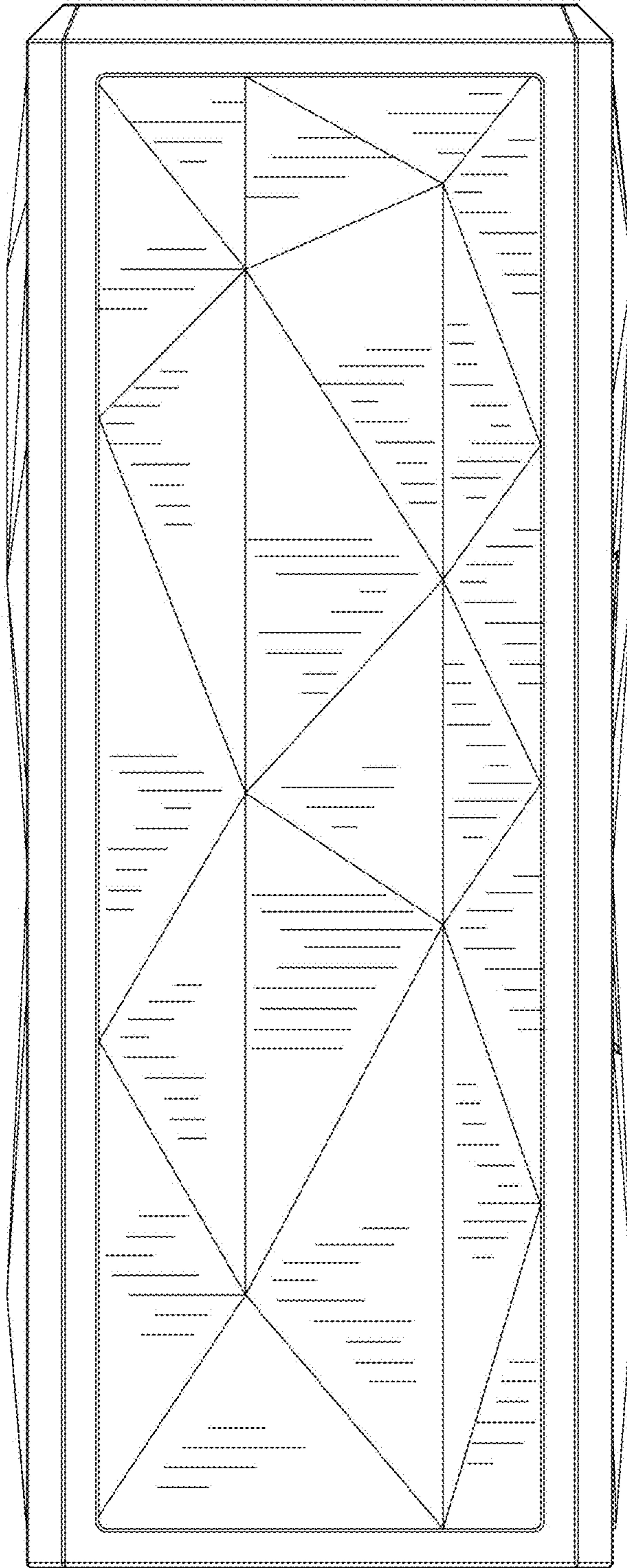

FIG. 6

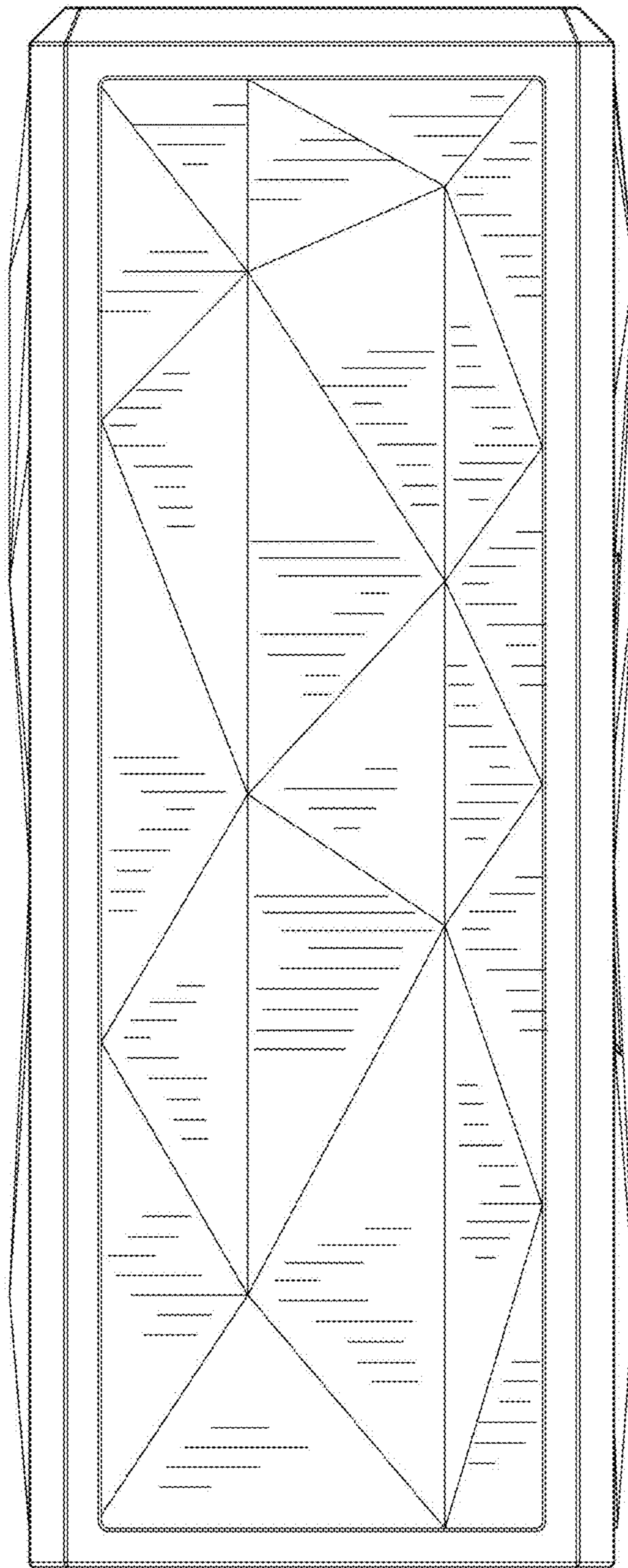

FIG. 7

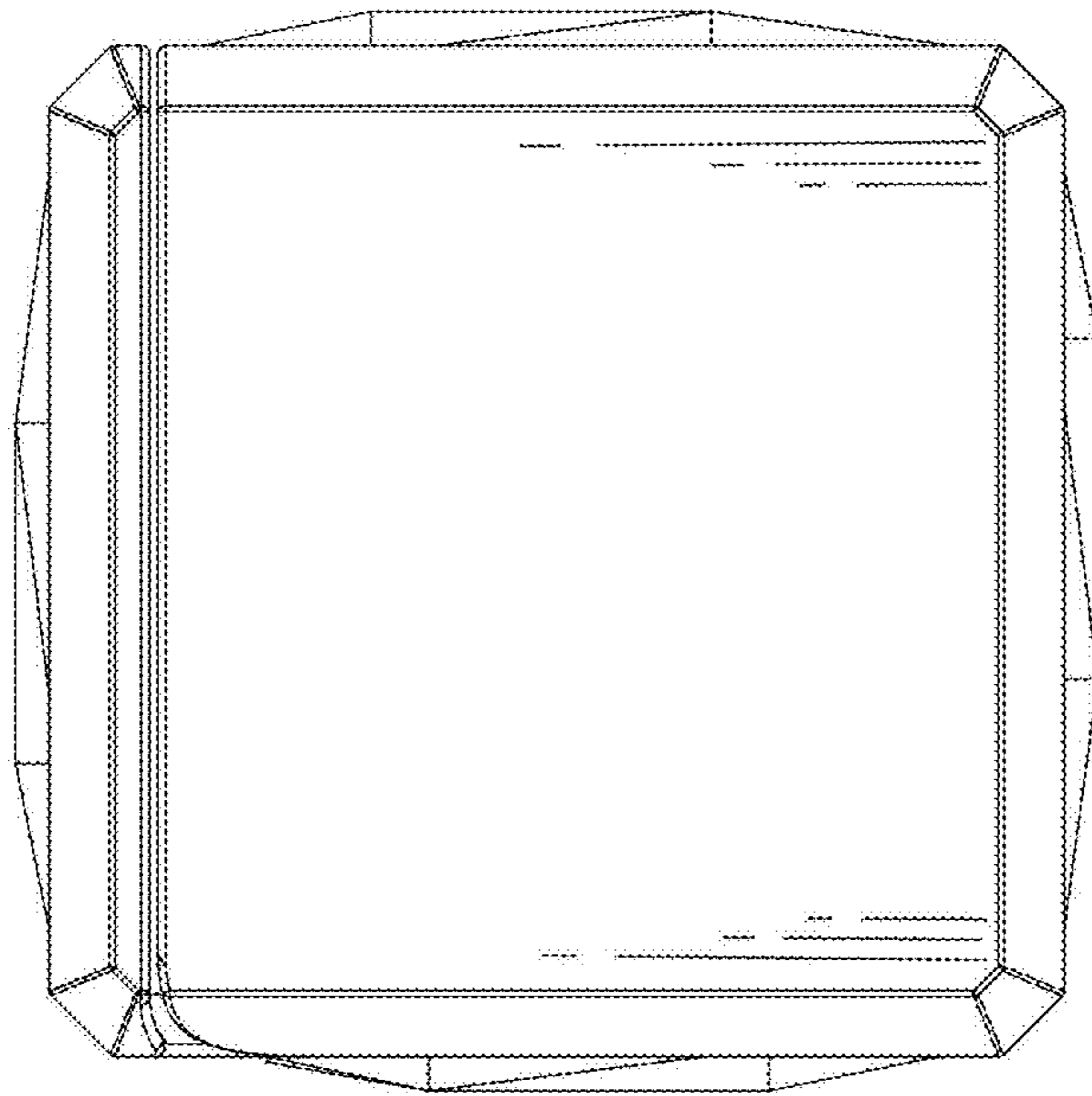

FIG. 8

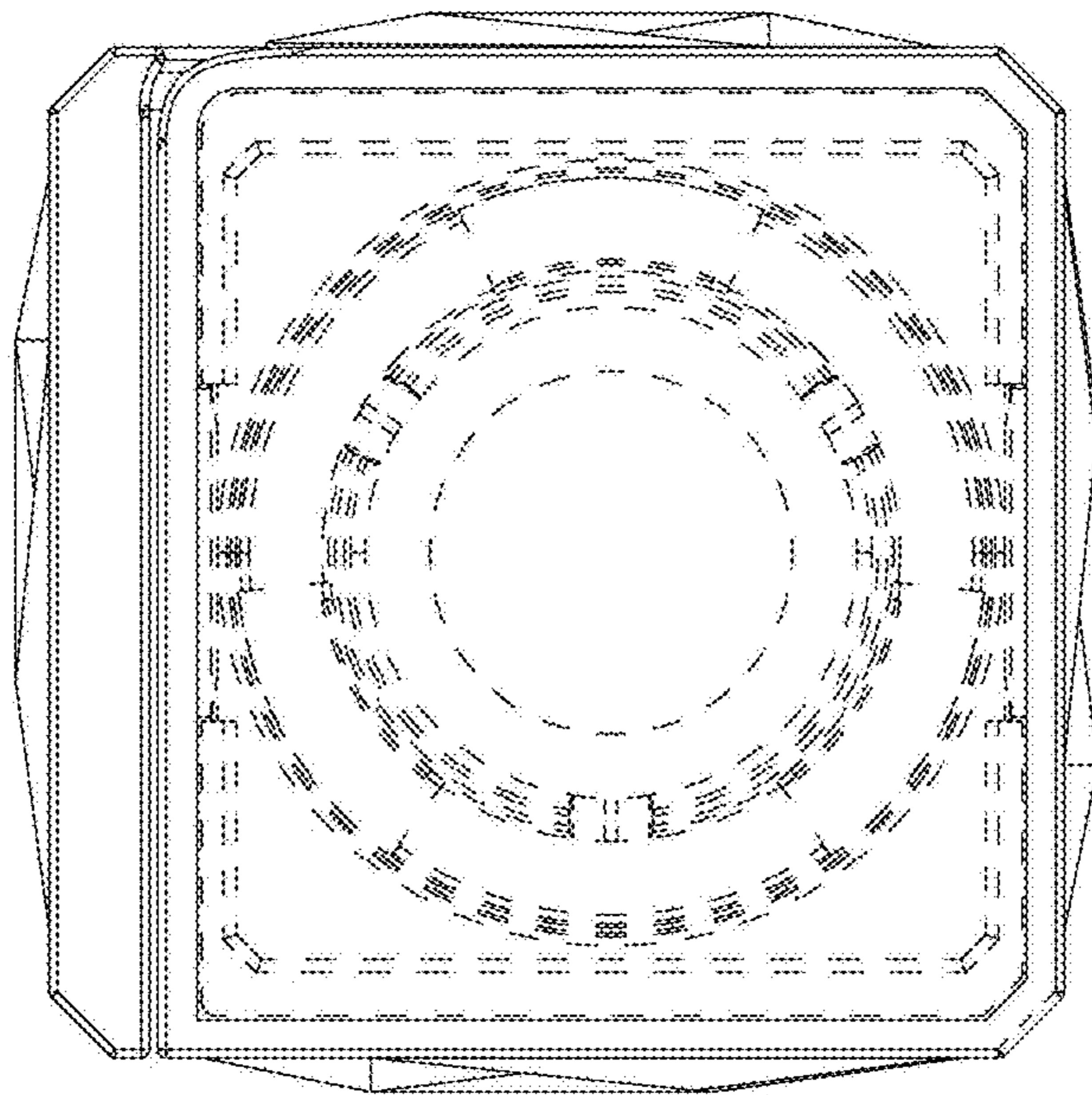

FIG. 9

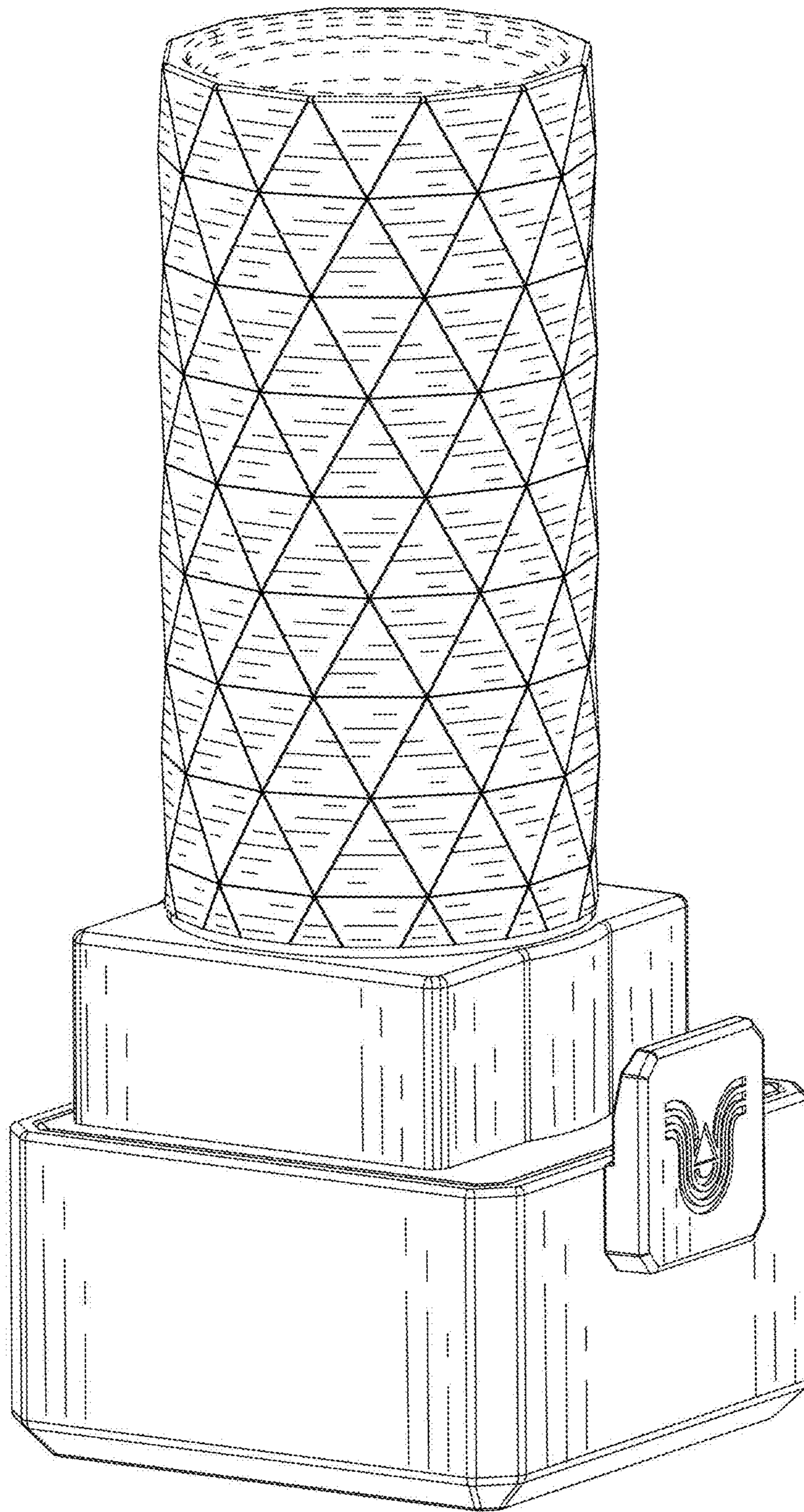

FIG. 10

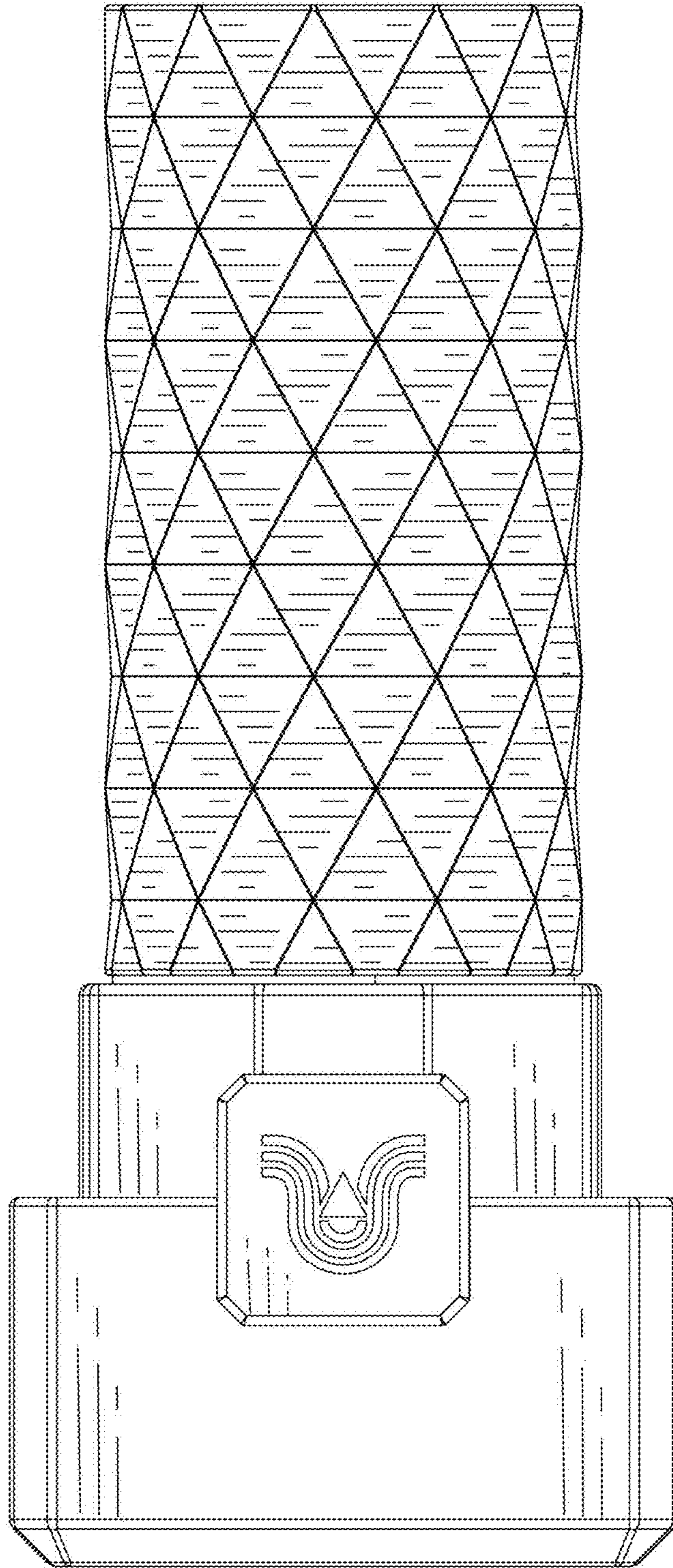

FIG. 11

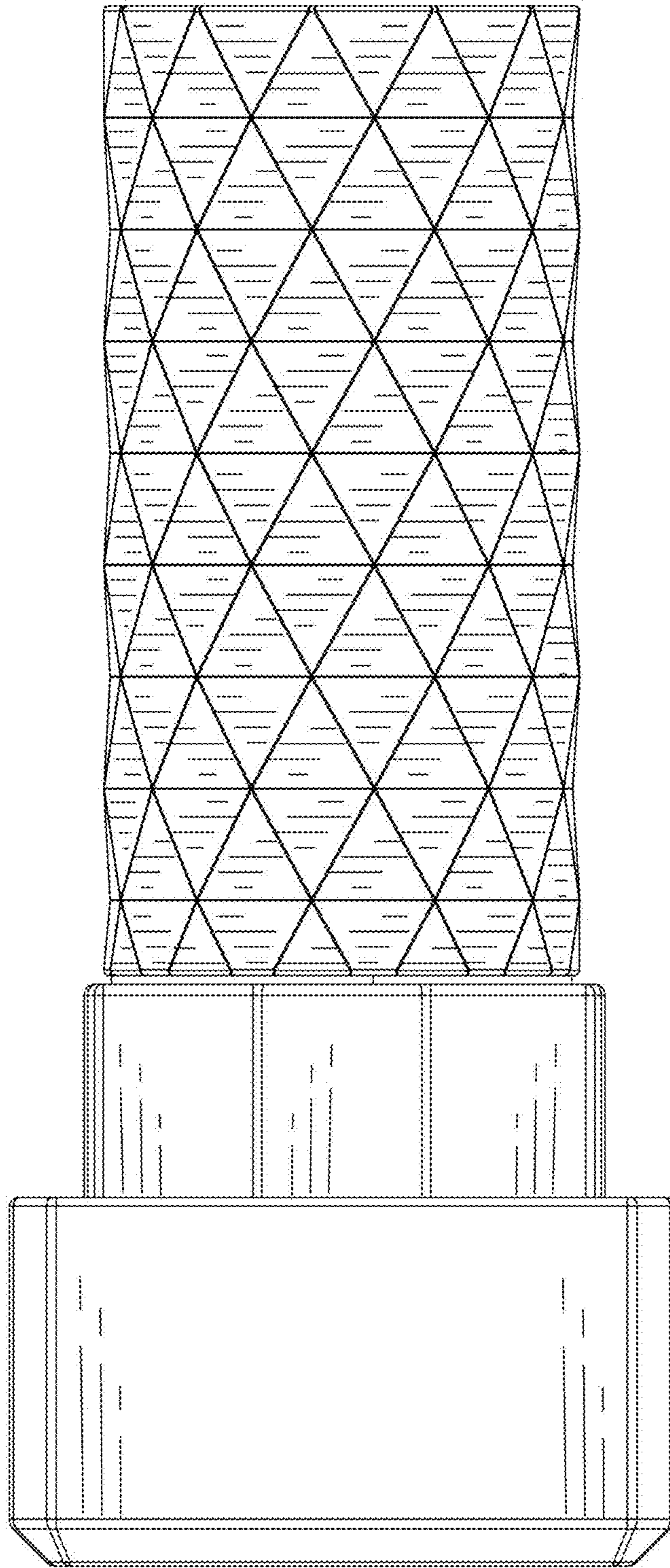

FIG. 12

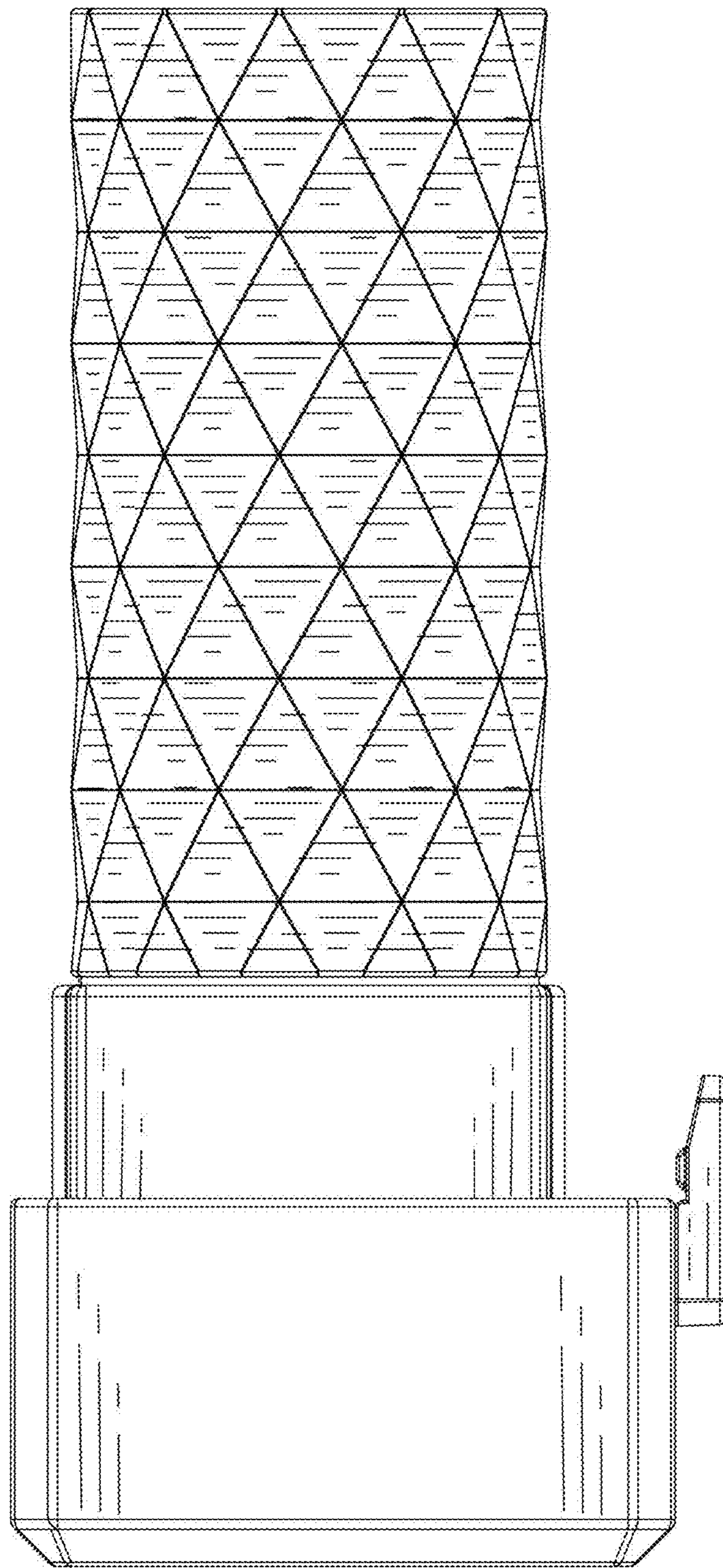

FIG. 13

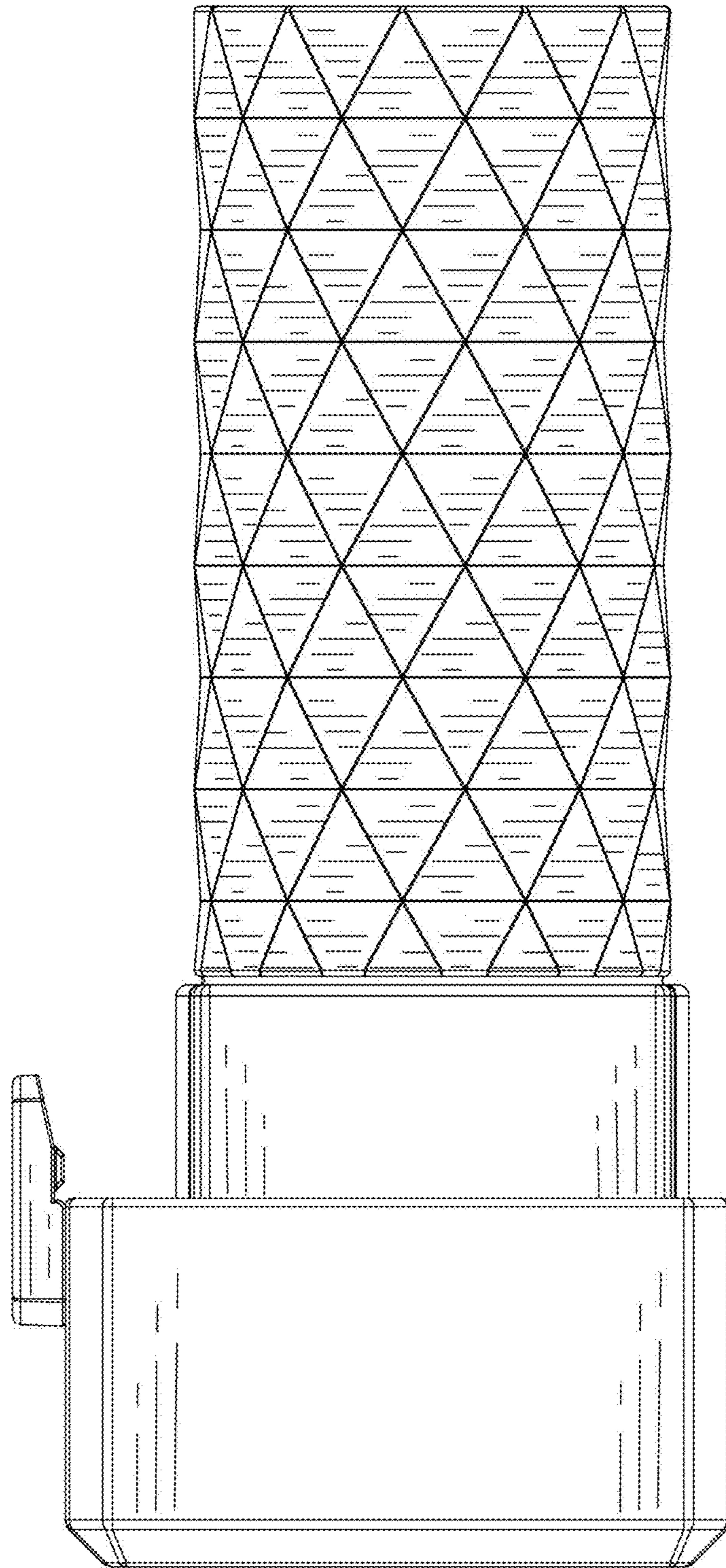

FIG. 14

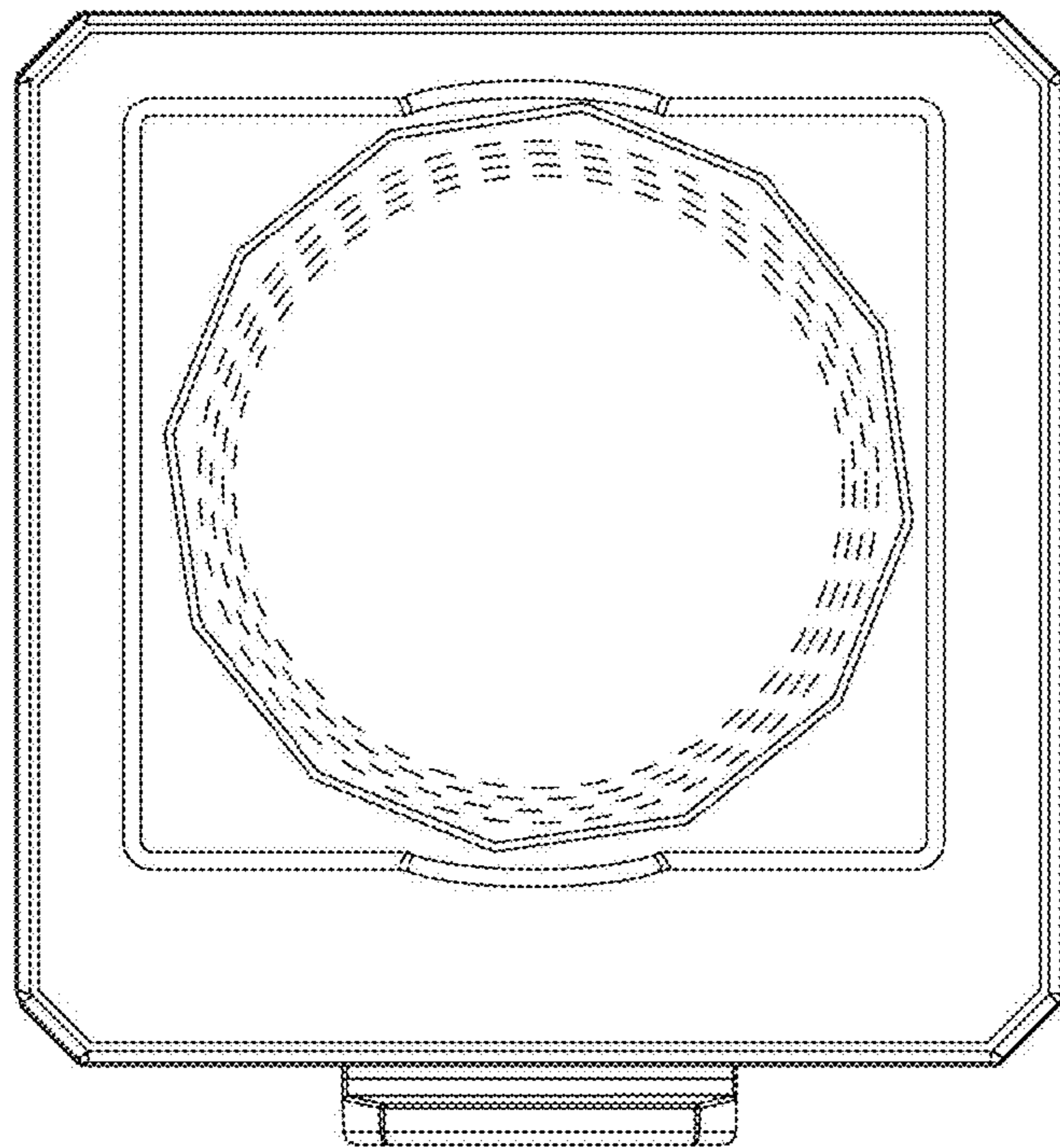

FIG. 15

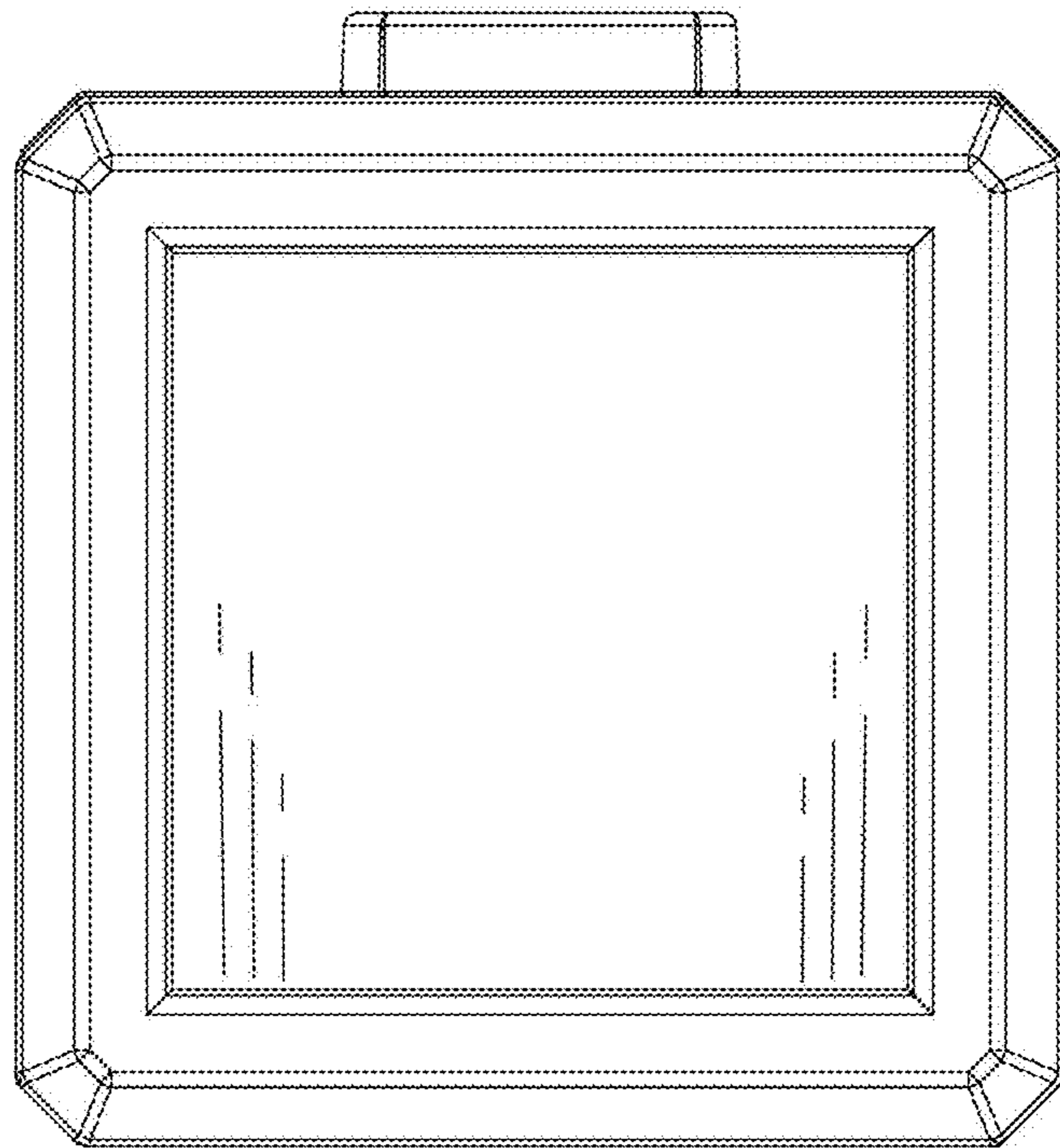

FIG. 16