



US00D933894S

(12) **United States Design Patent** (10) **Patent No.:** **US D933,894 S**  
**Van Roosmalen et al.** (45) **Date of Patent:** **\*\* Oct. 19, 2021**

(54) **SHAVER**

*Primary Examiner* — Jennifer Rivard

(71) Applicant: **KONINKLIJKE PHILIPS N.V.**,  
Eindhoven (NL)

(57) **CLAIM**  
The ornamental design for a shaver, as shown.

(72) Inventors: **Jos Van Roosmalen**, Amsterdam (NL);  
**Frank Verbrugge**, Rosmalen (NL);  
**Jens Andersson**, Amsterdam (NL);  
**Roel Krooshof**, Bilthoven (NL); **Simon Van Anken**, Amsterdam (NL); **Peter Gal**, Amsterdam (NL); **Lieven Adriaenssen**, Vilvoorde (BE); **Roshan Hakkim**, Amsterdam (NL); **Mingshuo Zhang**, Amstelveen (NL)

**DESCRIPTION**

(73) Assignee: **KONINKLIJKE PHILIPS N.V.**,  
Eindhoven (NL)

(\*\*) Term: **15 Years**

(21) Appl. No.: **29/723,224**

(22) Filed: **Feb. 5, 2020**

(51) **LOC (13) Cl.** ..... **28-03**

(52) **U.S. Cl.**  
USPC ..... **D28/50**

(58) **Field of Classification Search**  
USPC ..... D28/49–54

(Continued)

(56) **References Cited**

U.S. PATENT DOCUMENTS

D326,738 S \* 6/1992 Mauro ..... D28/50  
D389,276 S \* 1/1998 Bone ..... D28/50

(Continued)

OTHER PUBLICATIONS

Ultimate guide to electric shavers 2021, downloaded Feb. 2021, 23 pages <https://www.allaboutrazor.com/corded-electric-shaver/> (Year: 2021).\*

FIG. 1 is a perspective view showing the first embodiment of a shaver;  
 FIG. 2 is a front elevational view thereof;  
 FIG. 3 is a rear elevational view thereof;  
 FIG. 4 is a right side elevational view thereof;  
 FIG. 5 is a left side elevational view thereof;  
 FIG. 6 is a top plan view thereof;  
 FIG. 7 is a bottom plan view thereof;  
 FIG. 8 is a perspective view showing the second embodiment of a shaver;  
 FIG. 9 is a front elevational view thereof;  
 FIG. 10 is a rear elevational view thereof;  
 FIG. 11 is a right side elevational view thereof;  
 FIG. 12 is a left side elevational view thereof;  
 FIG. 13 is a top plan view thereof;  
 FIG. 14 is a bottom plan view thereof;  
 FIG. 15 is a perspective view showing a third embodiment of a shaver;  
 FIG. 16 is a front elevational view thereof;  
 FIG. 17 is a rear elevational view thereof;  
 FIG. 18 is a right side elevational view thereof;  
 FIG. 19 is a left side elevational view thereof;  
 FIG. 20 is a top plan view thereof;  
 FIG. 21 is a bottom plan view thereof;  
 FIG. 22 is a perspective view showing the fourth embodiment of a shaver;  
 FIG. 23 is a front elevational view thereof;  
 FIG. 24 is a rear elevational view thereof;  
 FIG. 25 is a right side elevational view thereof;  
 FIG. 26 is a left side elevational view thereof;  
 FIG. 27 is a top plan view thereof;  
 FIG. 28 is a bottom plan view thereof;  
 FIG. 29 is a perspective view showing the fifth embodiment of a shaver;  
 FIG. 30 is a front elevational view thereof;  
 FIG. 31 is a rear elevational view thereof;  
 FIG. 32 is a right side elevational view thereof;

(Continued)

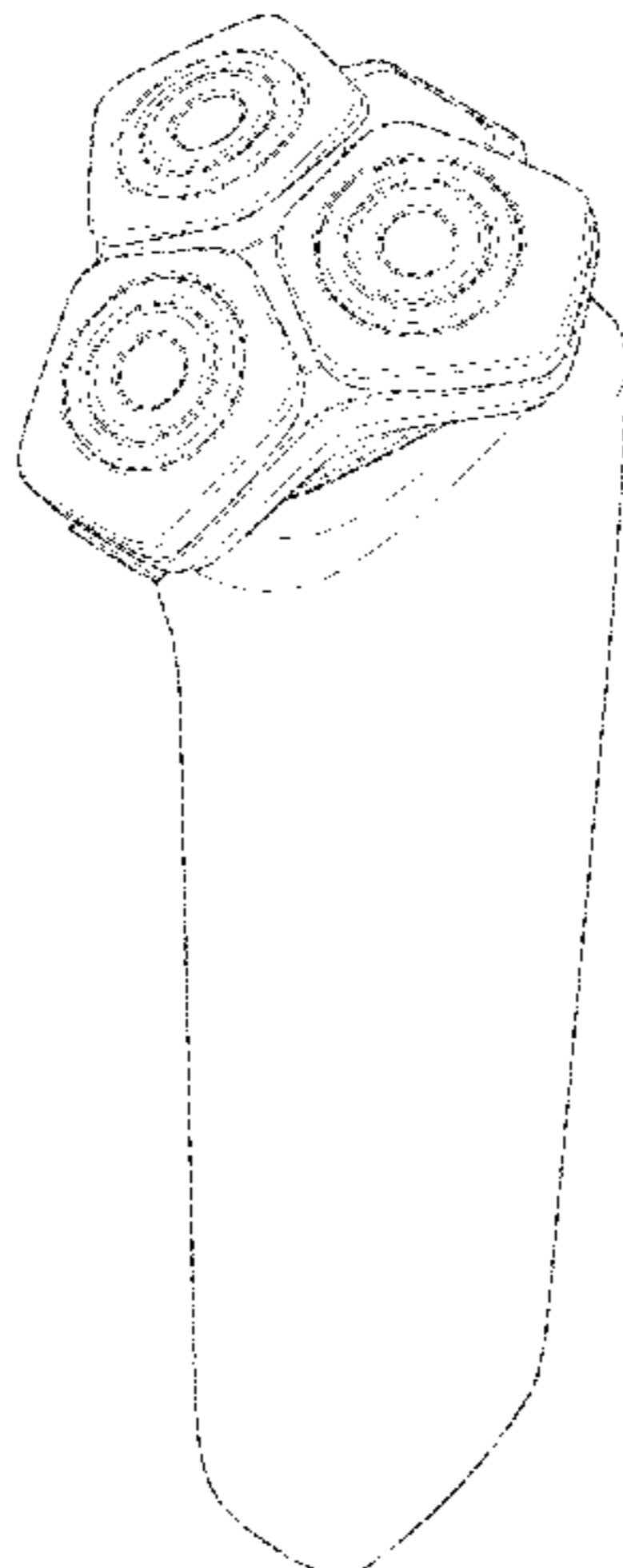

FIG. 33 is a left side elevational view thereof;  
 FIG. 34 is a top plan view thereof;  
 FIG. 35 is a bottom plan view thereof;  
 FIG. 36 is a perspective view showing a sixth embodiment of a shaver;  
 FIG. 37 is a front elevational view thereof;  
 FIG. 38 is a rear elevational view thereof;  
 FIG. 39 is a right side elevational view thereof;  
 FIG. 40 is a left side elevational view thereof;  
 FIG. 41 is a top plan view thereof; and,  
 FIG. 42 is a bottom plan view thereof.

**1 Claim, 36 Drawing Sheets**

(58) **Field of Classification Search**

CPC ..... B26B 19/14–18; B26B 19/38; B26B 19/3853–3893; B26B 19/3806–384  
 See application file for complete search history.

(56) **References Cited**

U.S. PATENT DOCUMENTS

D405,922	S	*	2/1999	Bone	.....	D28/50
D513,342	S	*	12/2005	Sulik	.....	D28/50
D520,681	S	*	5/2006	Beedham	.....	D28/50
D520,682	S	*	5/2006	Butcher	.....	D28/50
D542,473	S	*	5/2007	McLachlan	.....	D28/50
D544,999	S	*	6/2007	Prat-Pfister	.....	D28/50
D546,001	S	*	7/2007	McLachlan	.....	D28/50
D549,873	S	*	8/2007	Prat-Pfister	.....	D28/50
D550,901	S	*	9/2007	Massee	.....	D28/50
D563,599	S	*	3/2008	Prat-Pfister	.....	D28/50
D593,252	S	*	5/2009	Masuda	.....	D28/50
D601,301	S	*	9/2009	Bao	.....	D28/50
D604,013	S	*	11/2009	Qiu	.....	D28/50
D608,053	S	*	1/2010	Vetu	.....	D28/50

D620,198	S	*	7/2010	Nitz	.....	D28/50
D620,641	S	*	7/2010	Nitz	.....	D28/50
D620,642	S	*	7/2010	Nitz	.....	D28/50
D637,759	S	*	5/2011	Byun	.....	D28/50
D651,746	S	*	1/2012	Prat-Pfister	.....	D28/50
D654,223	S	*	2/2012	Aulwes	.....	D28/50
D675,779	S	*	2/2013	Vetu	.....	D28/50
D695,961	S	*	12/2013	Prat-Pfister	.....	D28/50
D695,962	S	*	12/2013	Prat-Pfister	.....	D28/50
D698,491	S	*	1/2014	Ellison	.....	D28/50
D737,514	S	*	8/2015	Roland	.....	D28/50
D737,515	S	*	8/2015	Roland	.....	D28/50
D738,042	S	*	9/2015	Roland	.....	D28/50
D748,857	S	*	2/2016	Boulanger	.....	D28/50
D758,014	S	*	5/2016	Smith	.....	D28/50
D758,015	S	*	5/2016	Prat-Pfister	.....	D28/50
D758,017	S	*	5/2016	Smith	.....	D28/54
D758,659	S	*	6/2016	Smith	.....	D28/50
D758,660	S	*	6/2016	Prat-Pfister	.....	D28/50
D776,348	S	*	1/2017	Frankel	.....	D28/50
D777,375	S	*	1/2017	Frankel	.....	D28/50
D777,376	S	*	1/2017	Frankel	.....	D28/50
D808,077	S	*	1/2018	Boulanger	.....	D28/50
D808,591	S	*	1/2018	Prat-Pfister	.....	D28/50
D812,301	S	*	3/2018	Yan	.....	D28/50
D819,274	S	*	5/2018	Yan	.....	D28/50
D821,032	S	*	6/2018	Prat-Pfister	.....	D28/50
D824,103	S	*	7/2018	Yan	.....	D28/50
D824,595	S	*	7/2018	Yan	.....	D28/50
D844,242	S	*	3/2019	Yan	.....	D28/50
D844,243	S	*	3/2019	Chen	.....	D28/50
D848,071	S	*	5/2019	Prat-Pfister	.....	D28/50
D848,072	S	*	5/2019	Prat-Pfister	.....	D28/50
D856,583	S	*	8/2019	Chen	.....	D28/50
D858,880	S	*	9/2019	Lu	.....	D28/50
D858,881	S	*	9/2019	Lu	.....	D28/50
D861,986	S	*	10/2019	Wang	.....	D28/50
D880,064	S	*	3/2020	Andersson	.....	D28/50
D884,972	S	*	5/2020	Andersson	.....	D28/50
D889,042	S	*	6/2020	Andersson	.....	D28/50
D902,486	S	*	11/2020	Andersson	.....	D28/50

\* cited by examiner

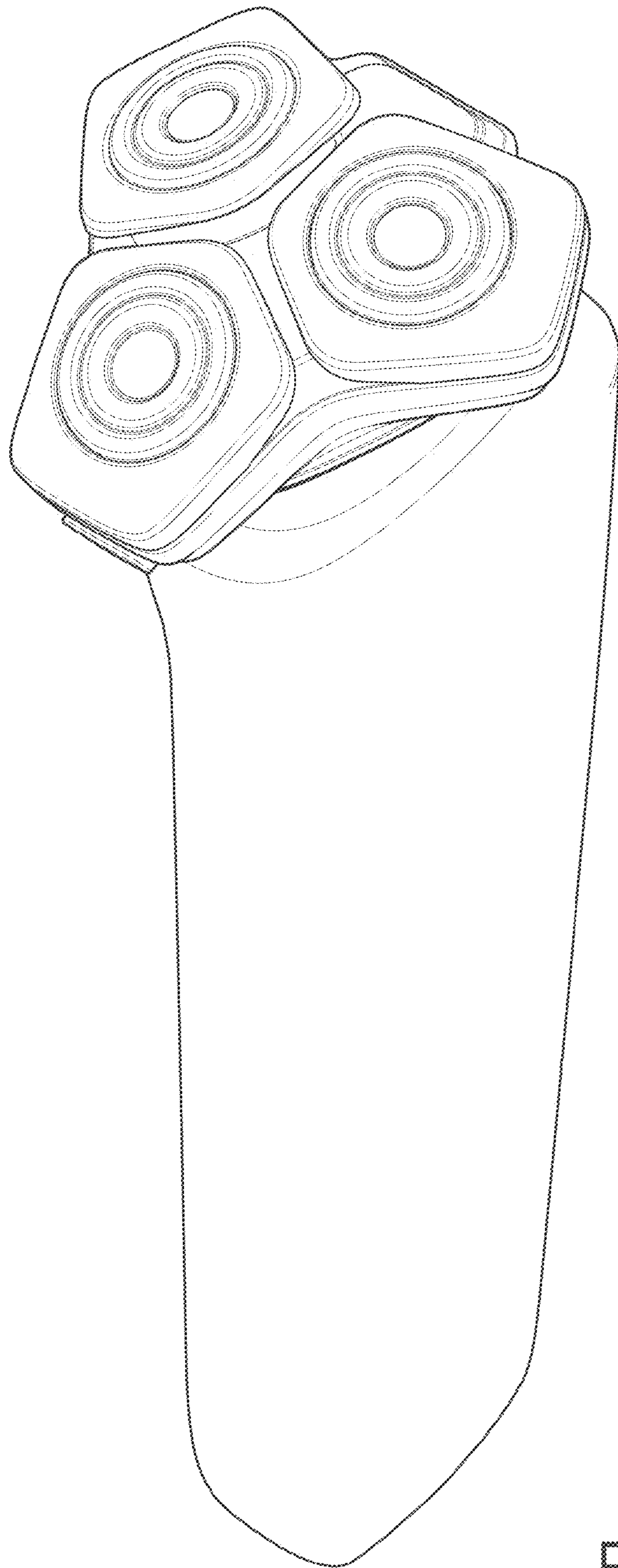

FIG. 1

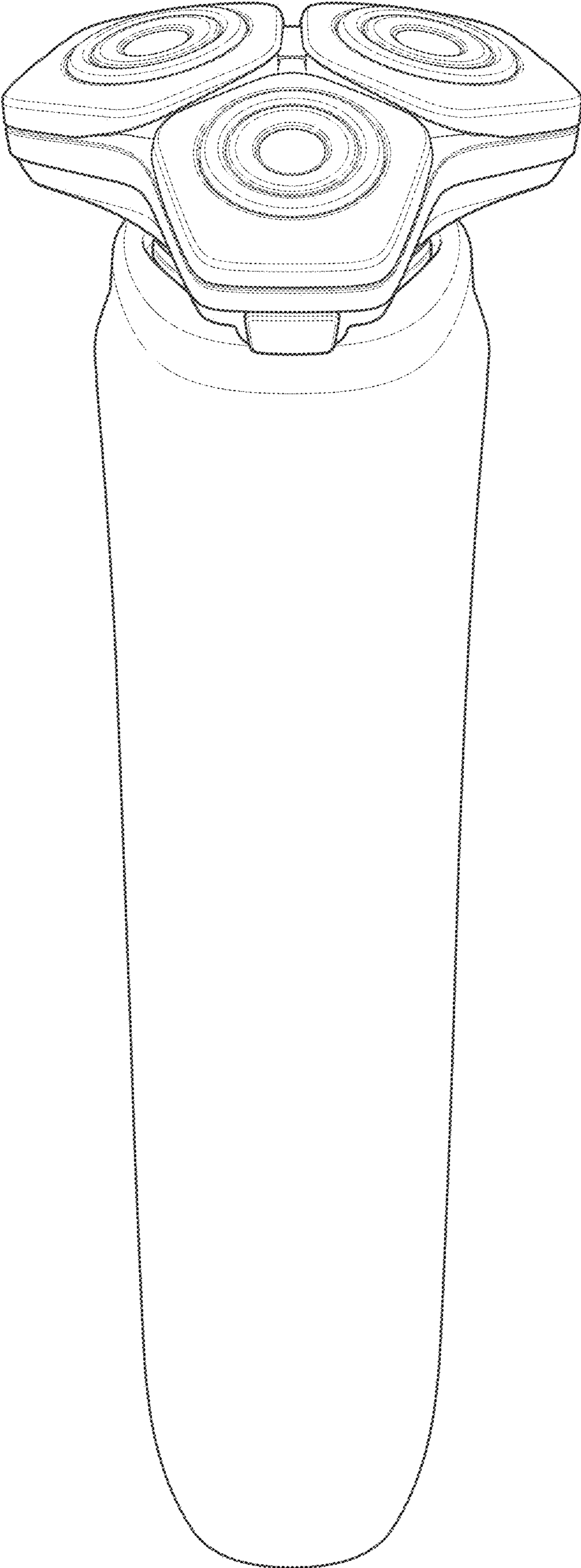

FIG. 2

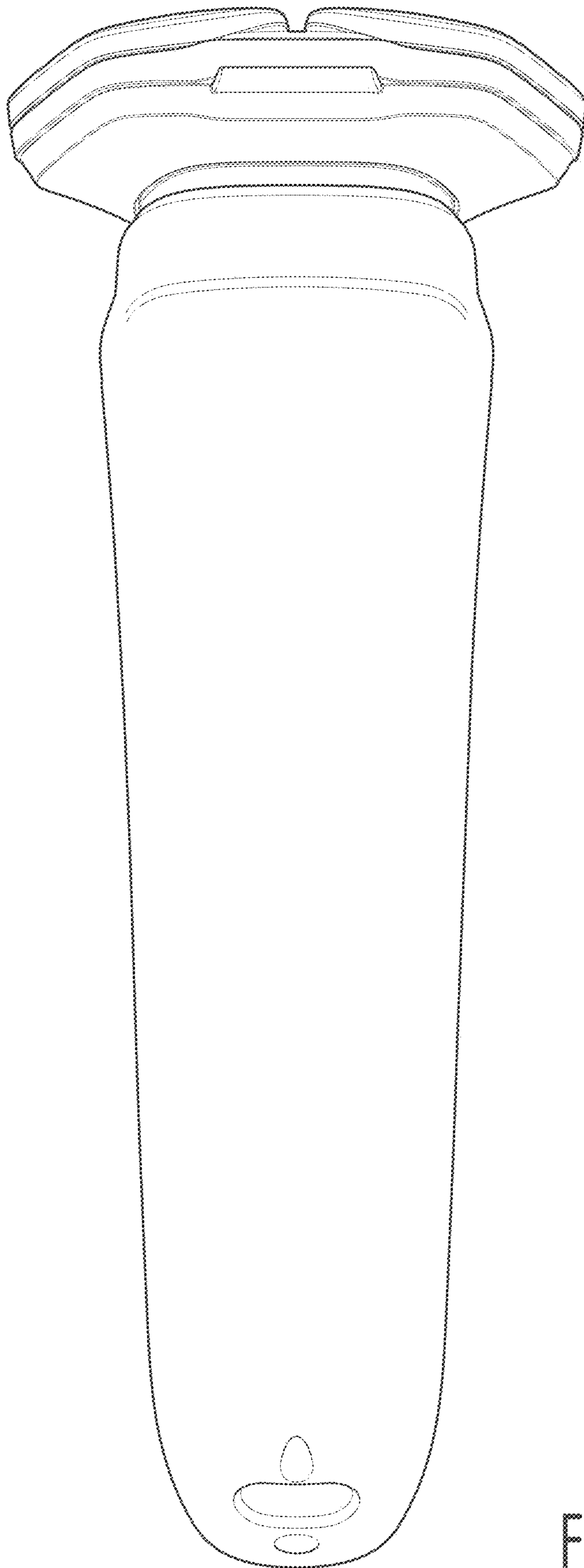

FIG. 3

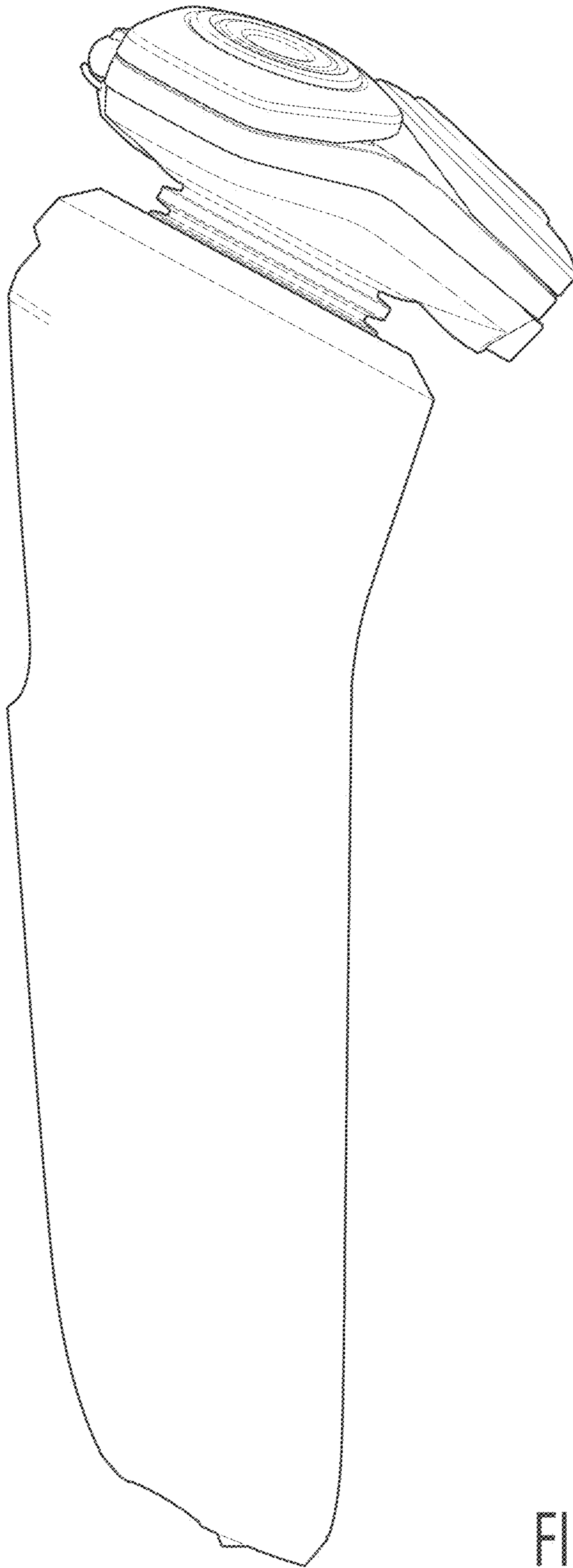

FIG. 4

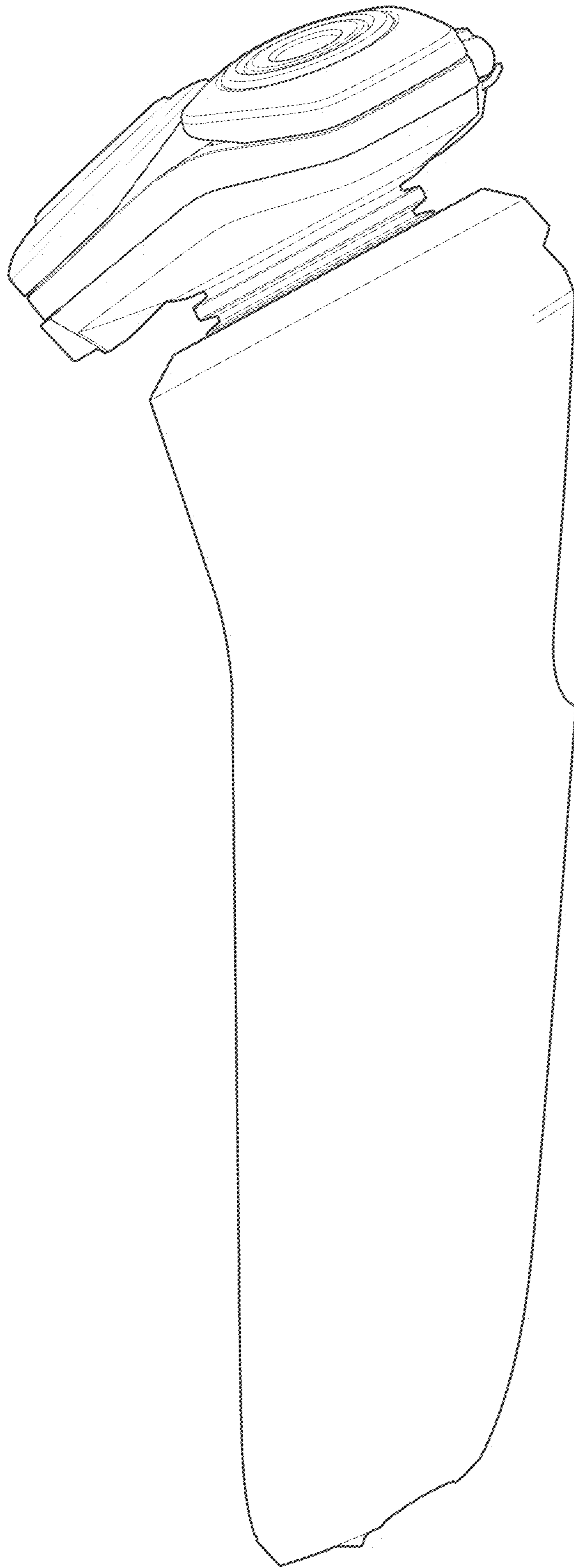

FIG. 5

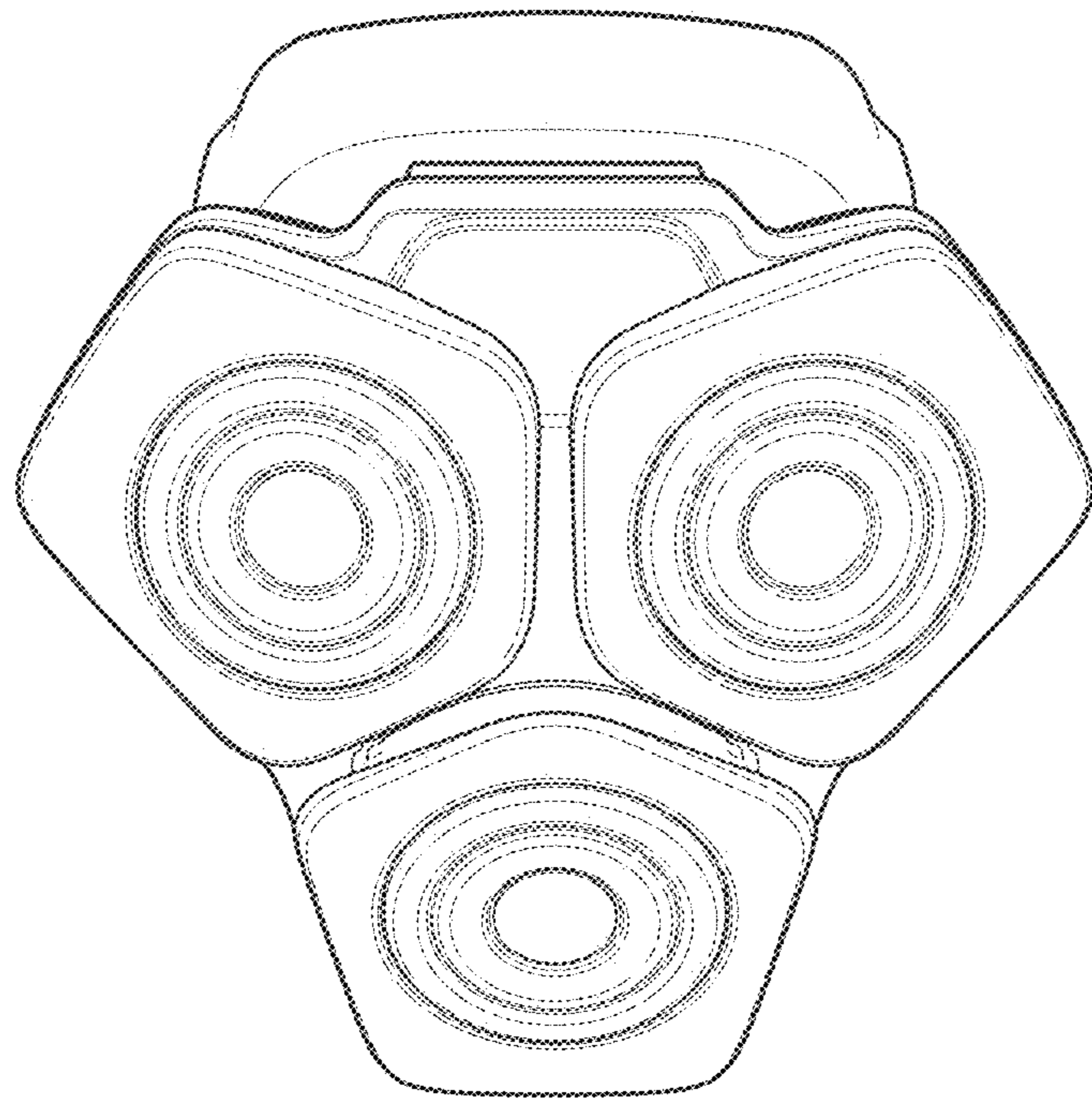

FIG. 6

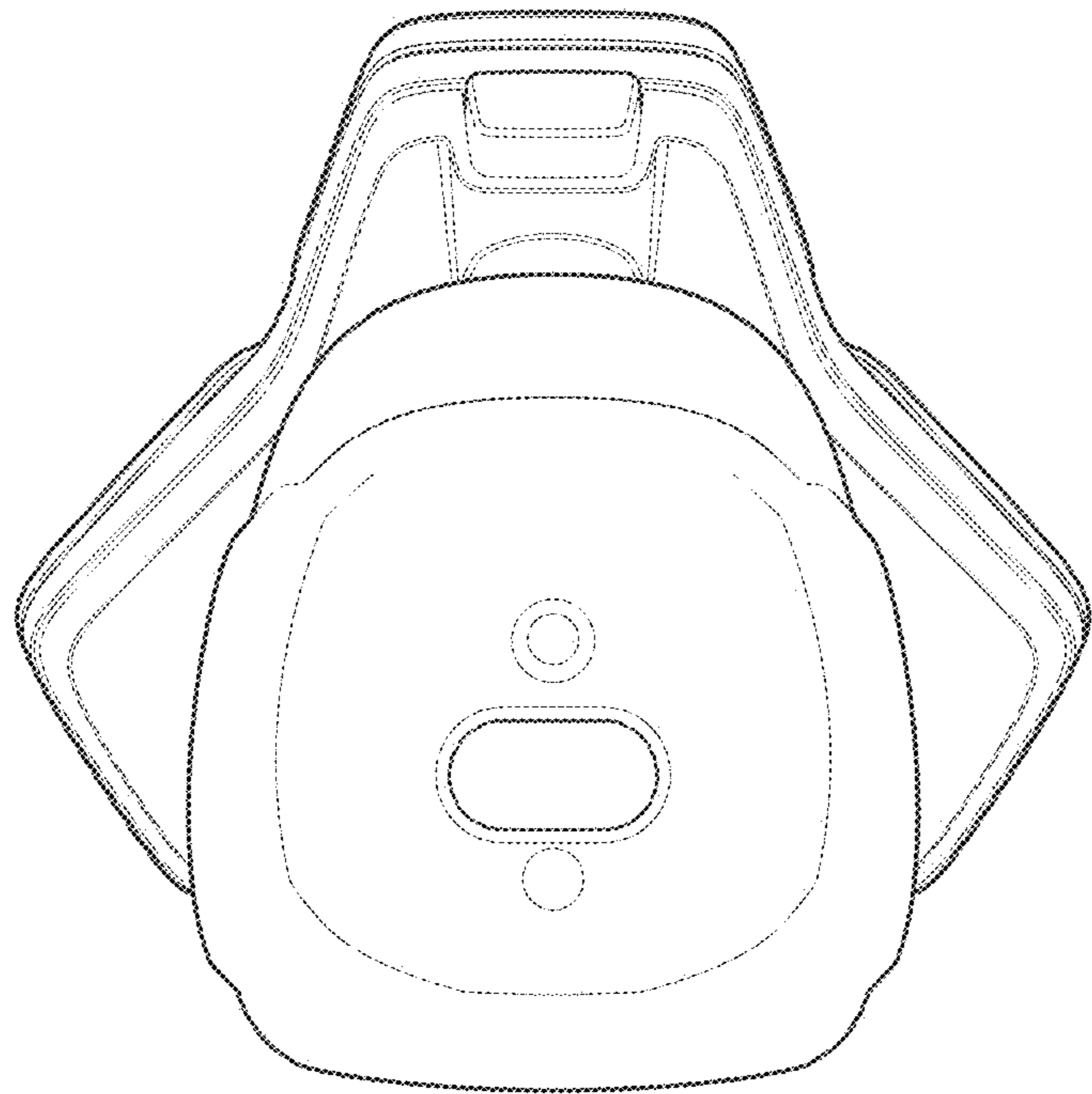

FIG. 7



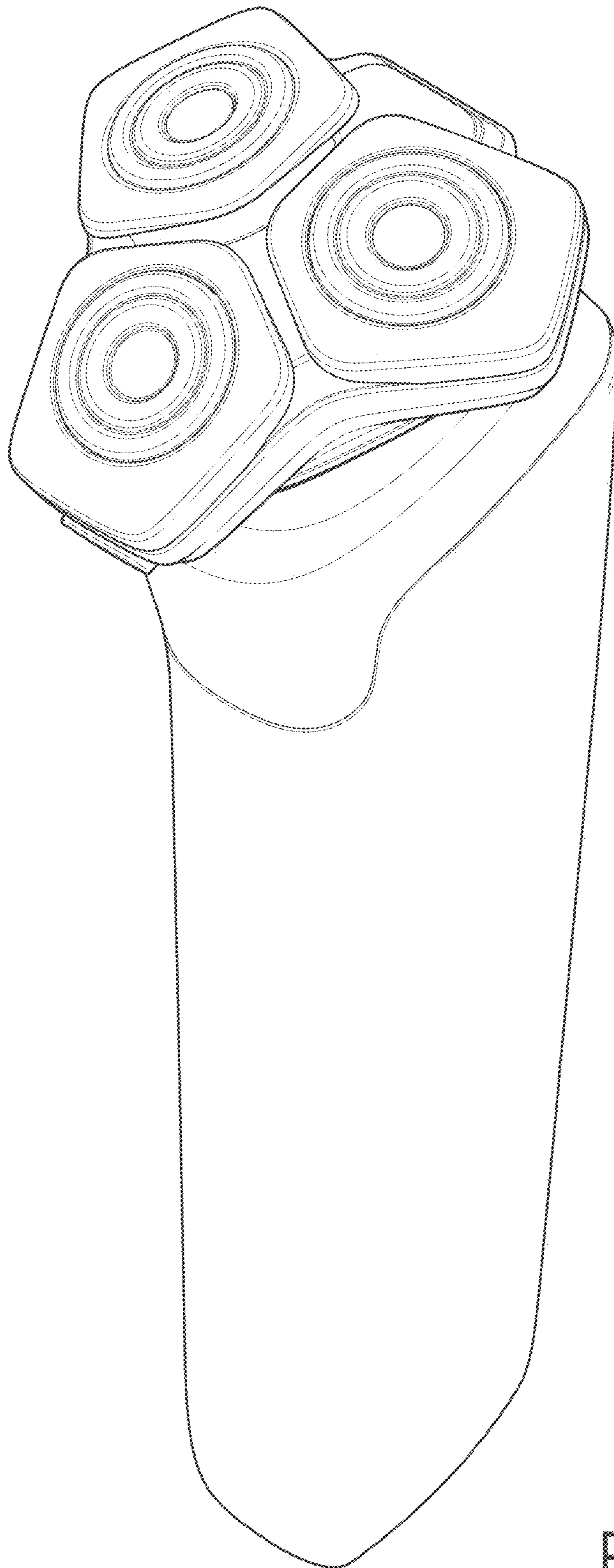

FIG. 8

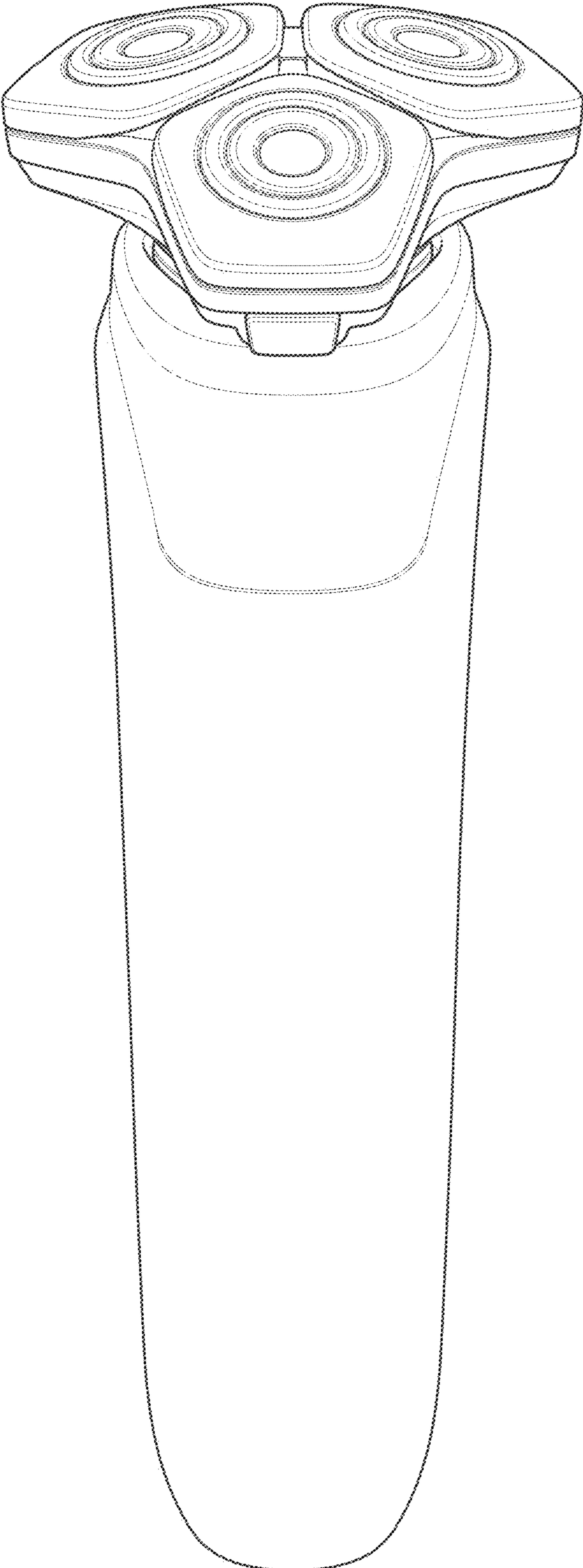

FIG. 9

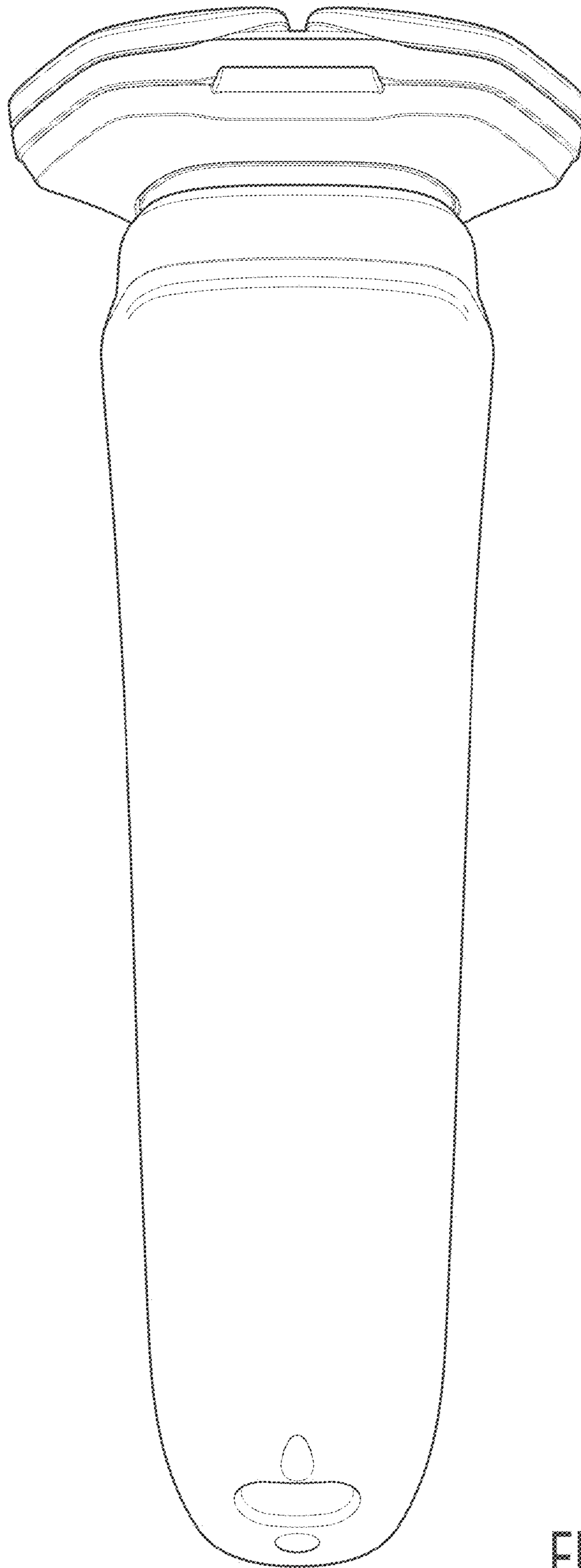

FIG. 10

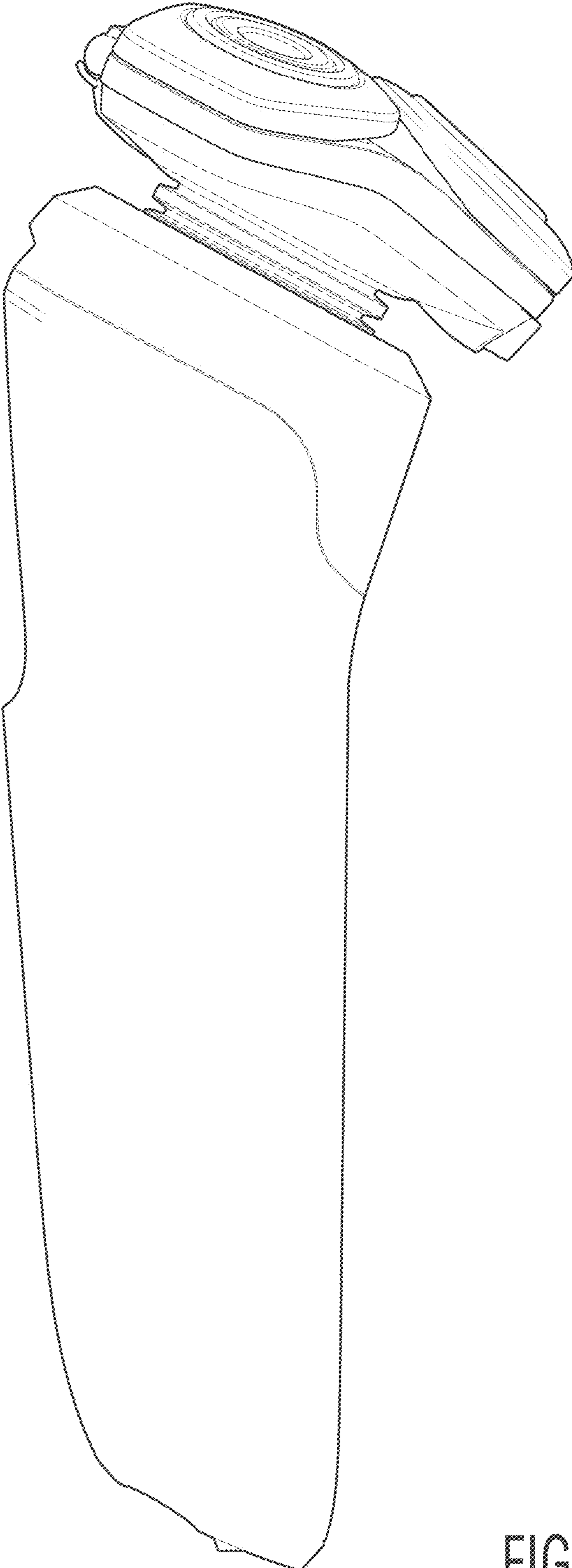

FIG. 11

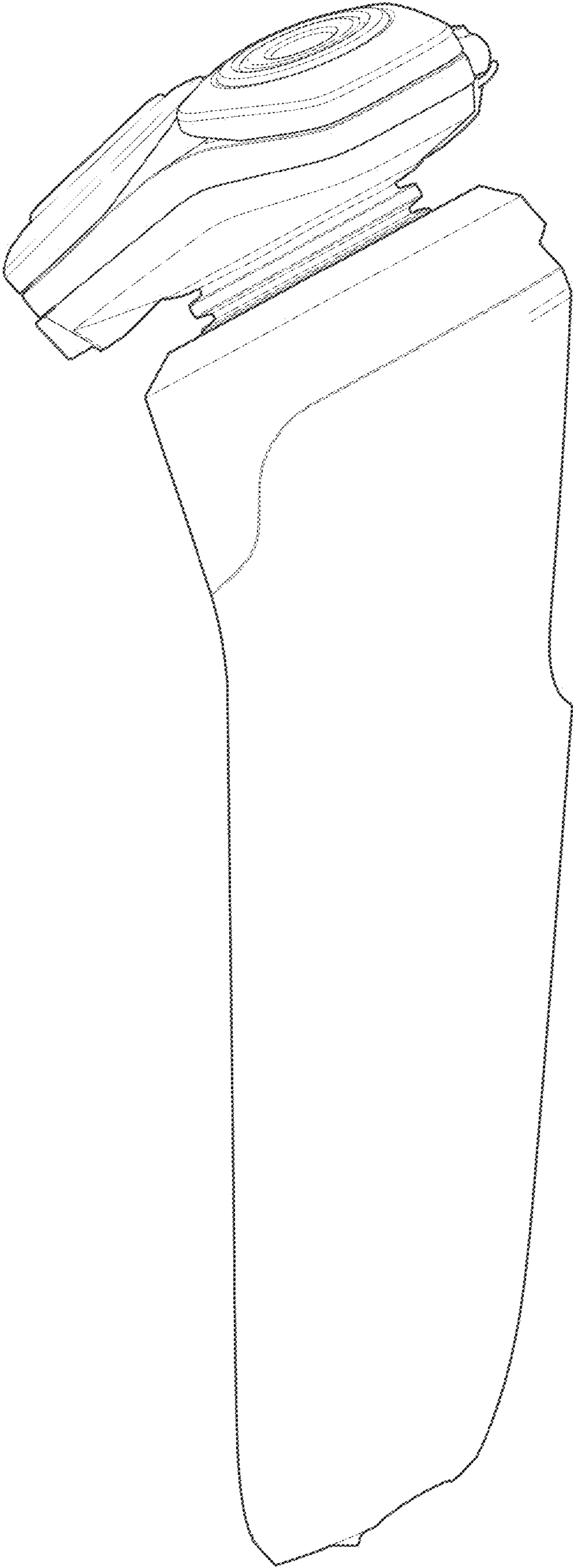

FIG. 12

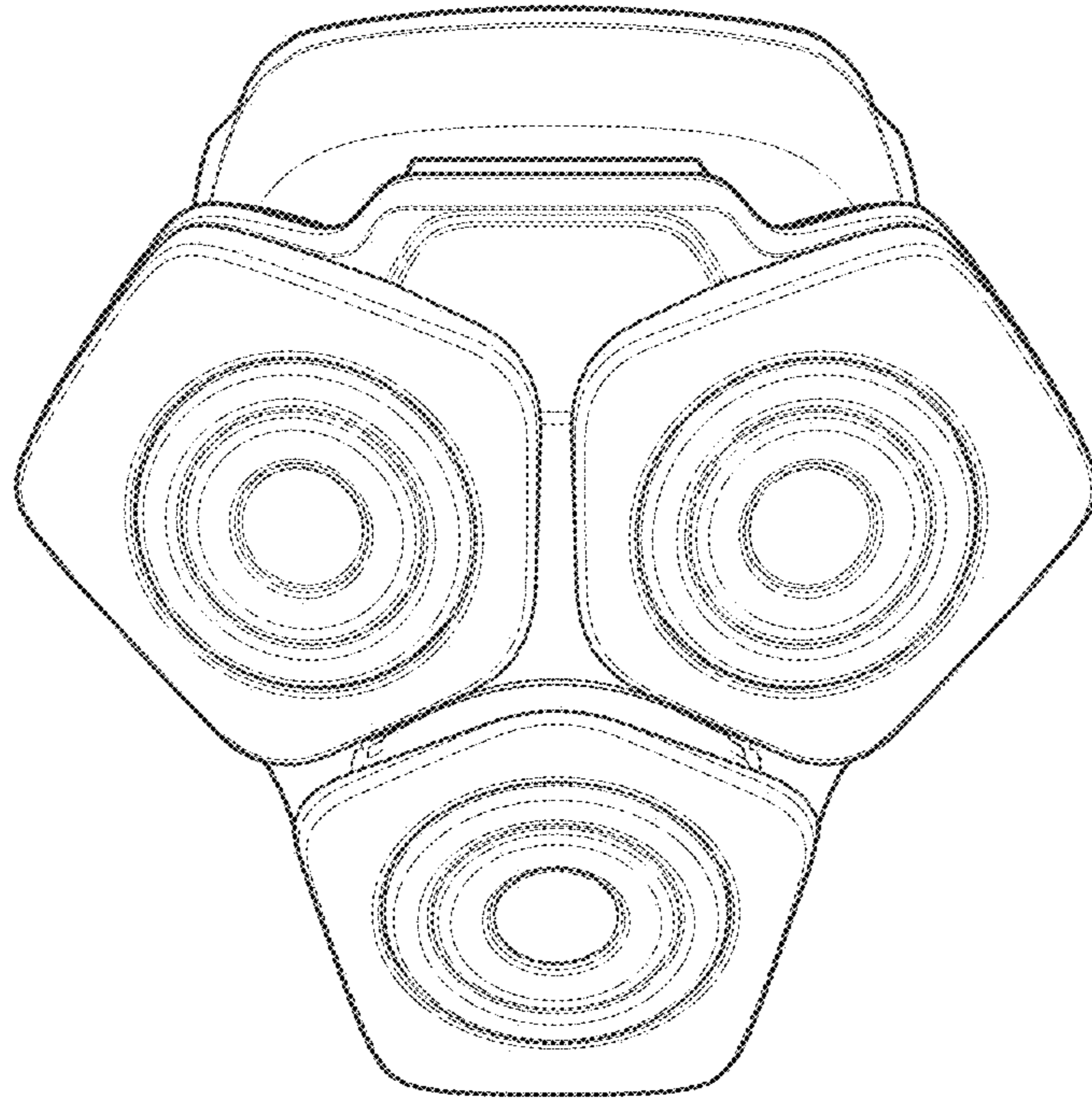

FIG. 13

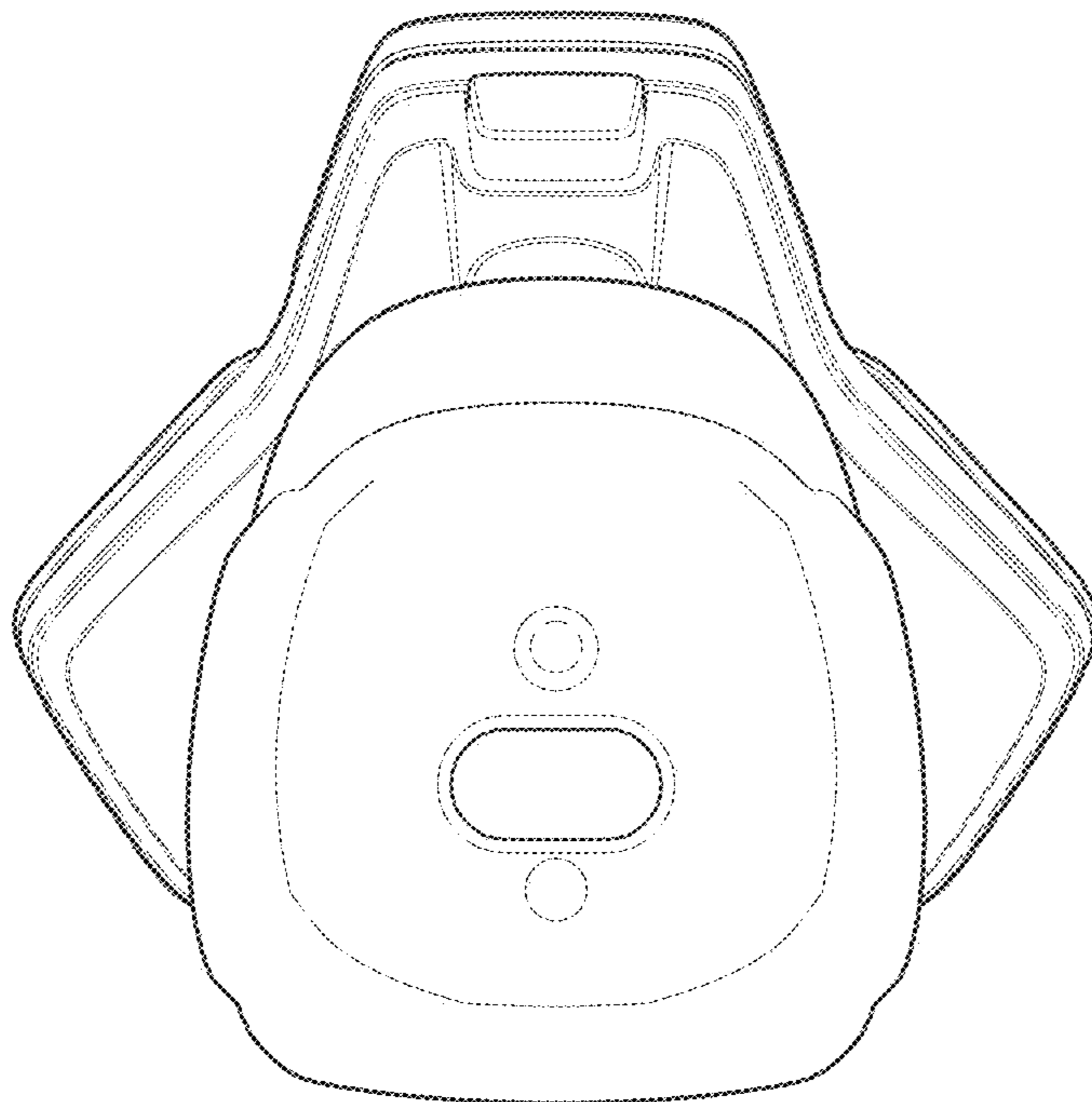

FIG. 14

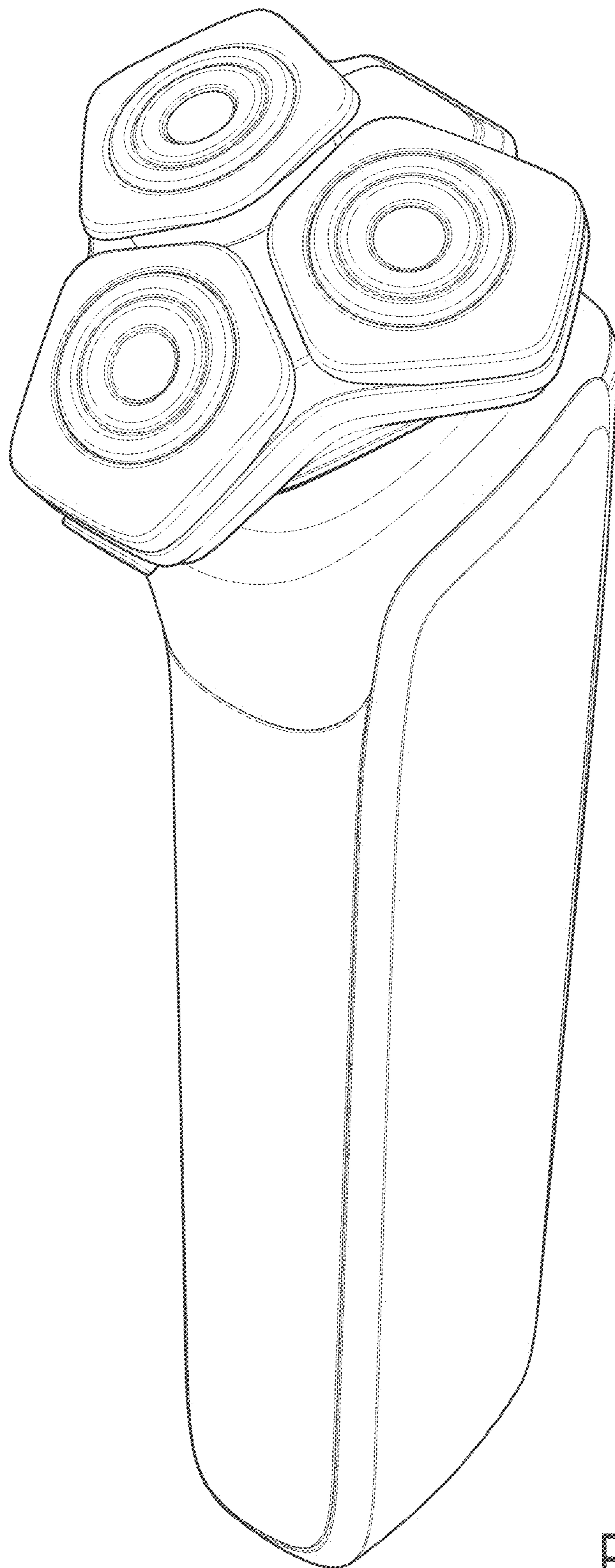

FIG. 15

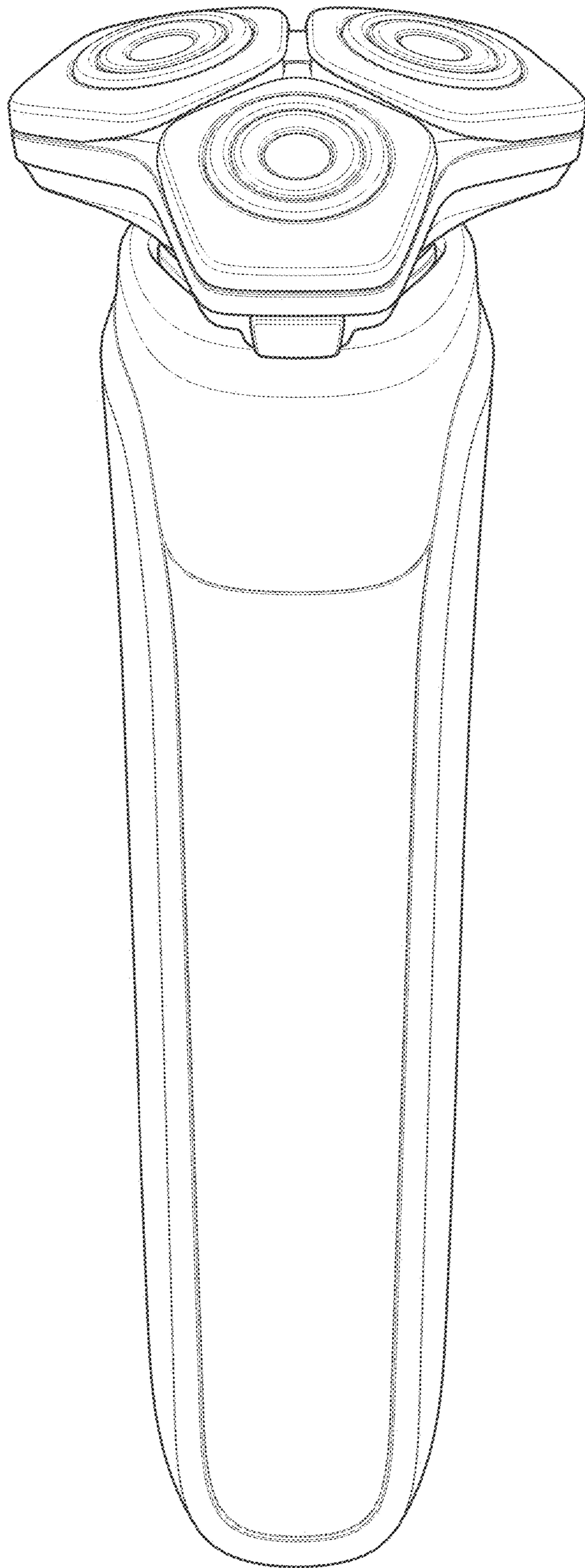

FIG. 16



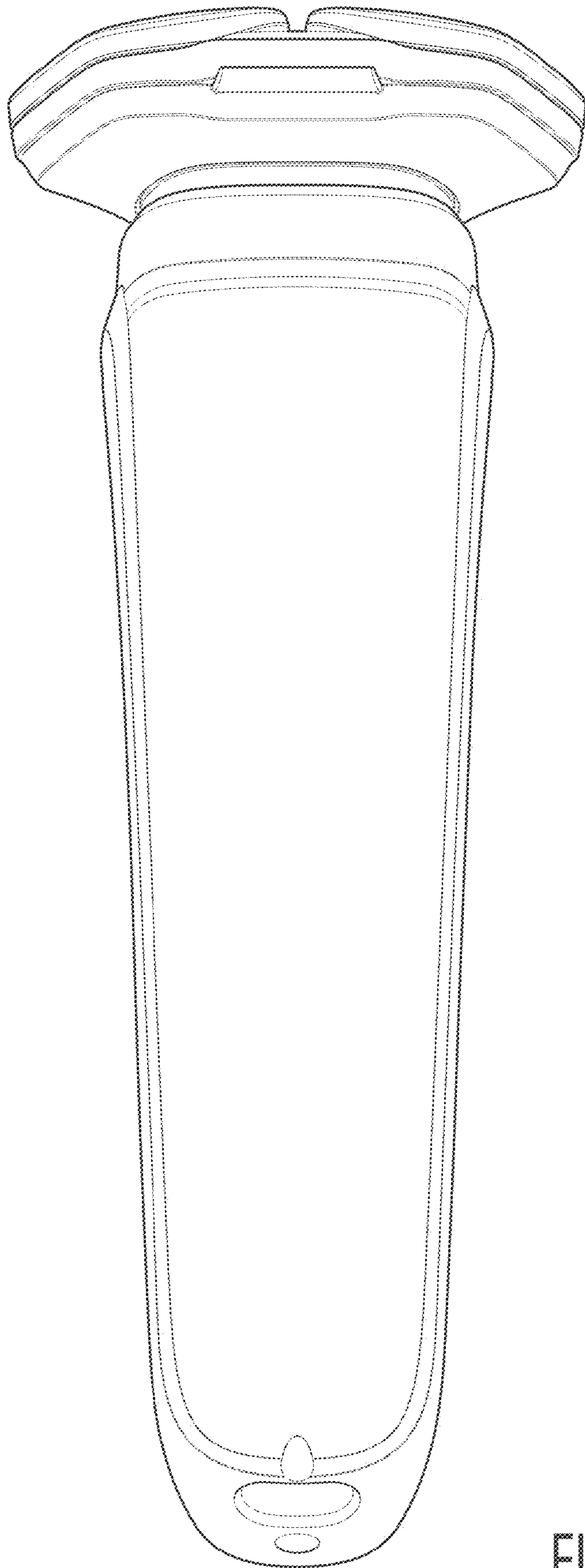

FIG. 17

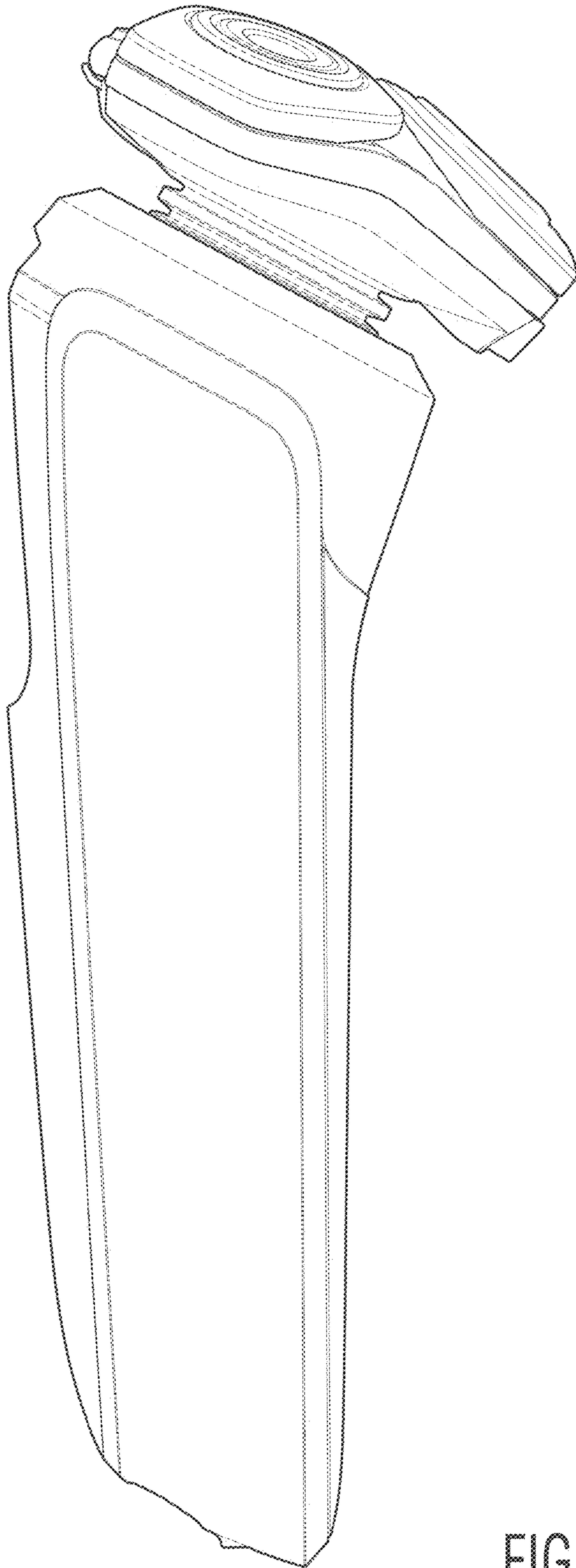

FIG. 18

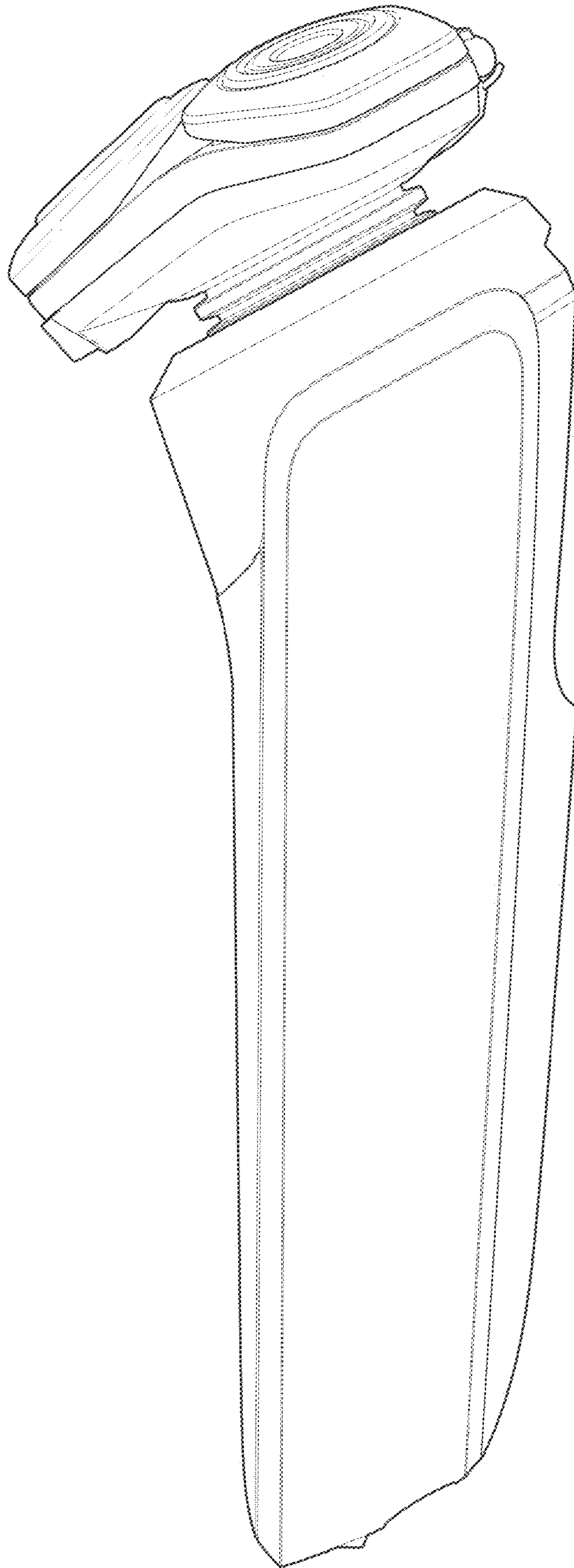

FIG. 19

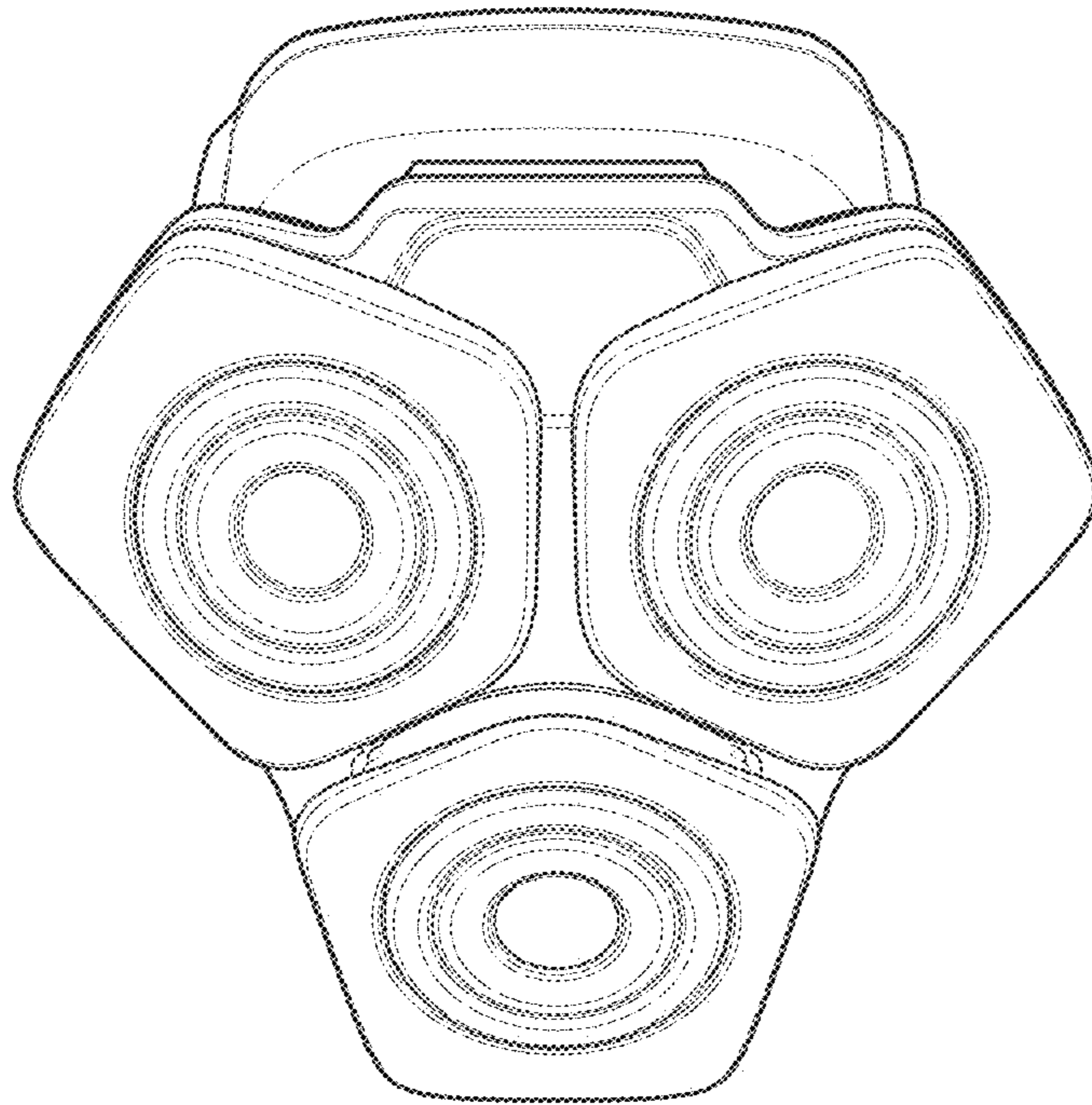

FIG. 20

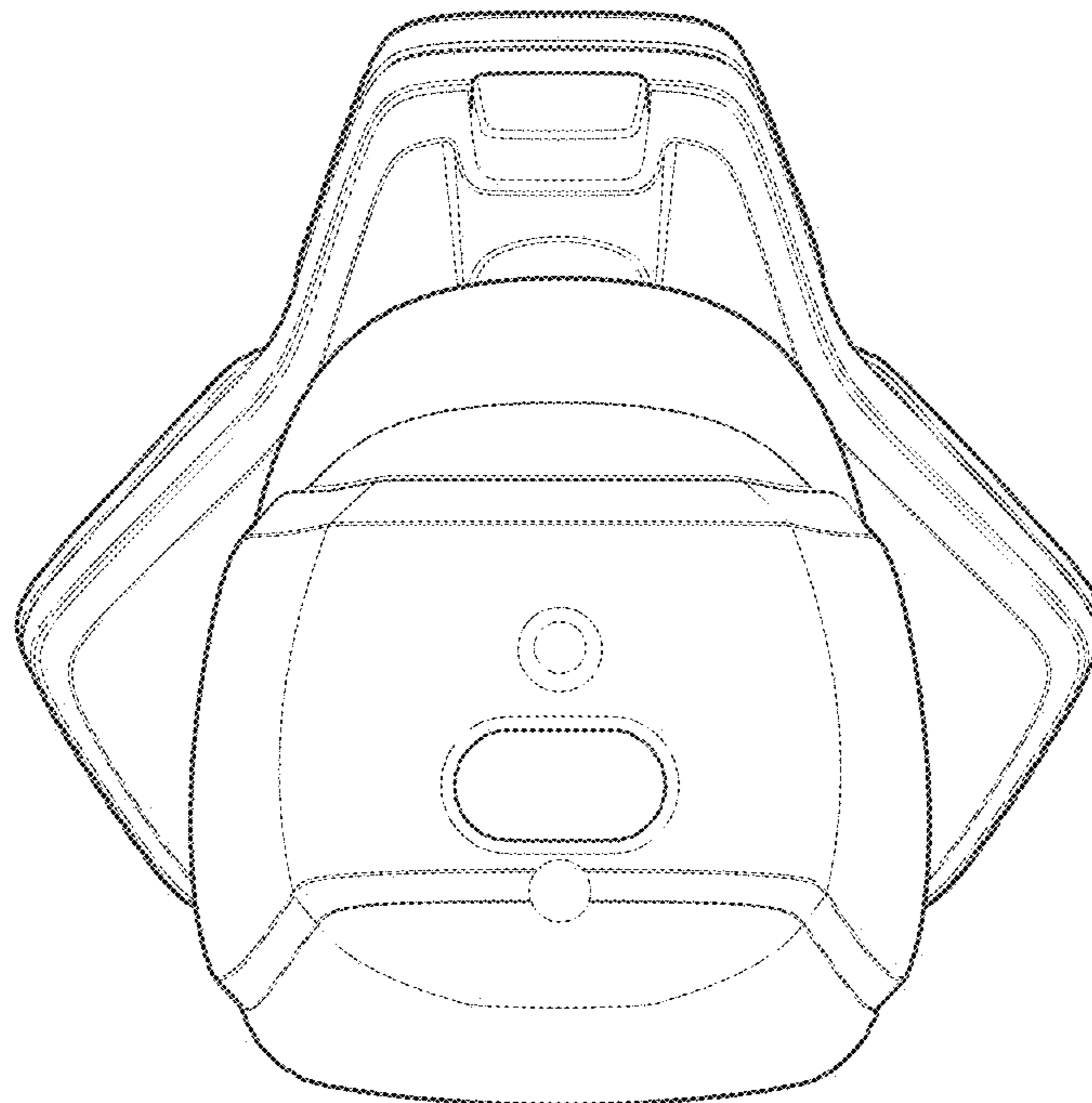

FIG. 21

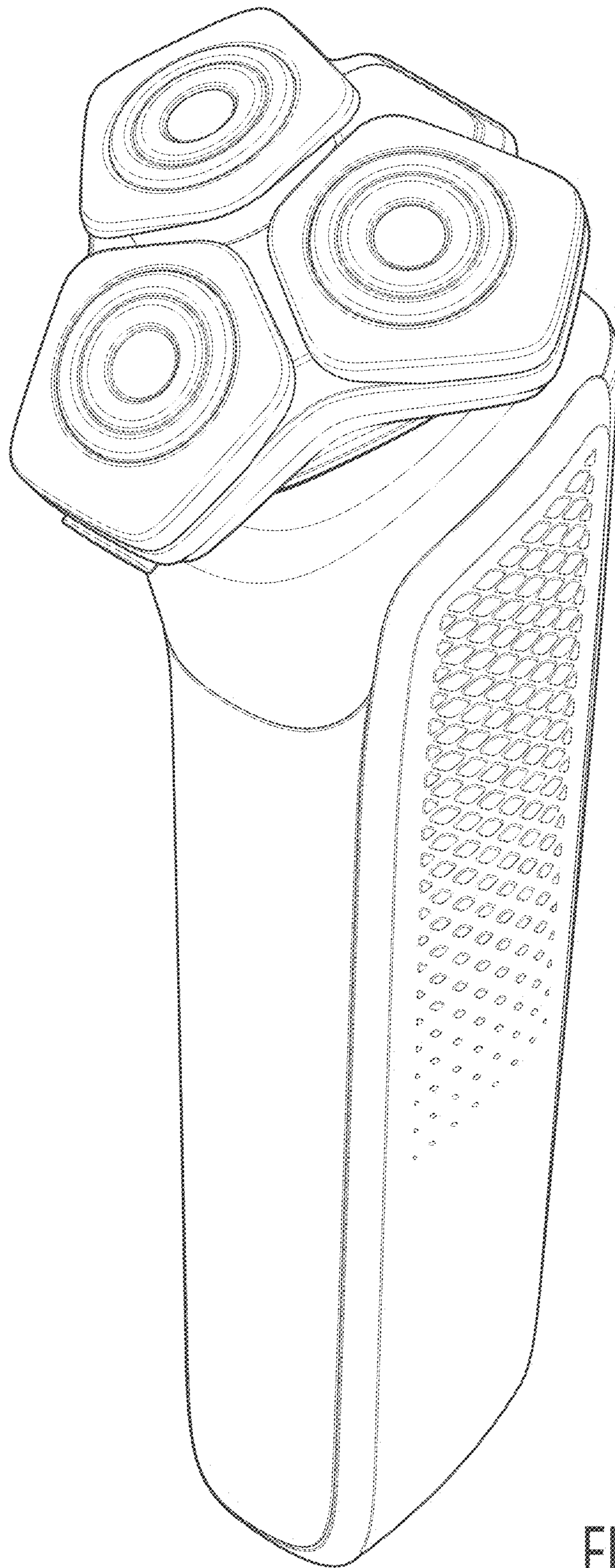

FIG. 22

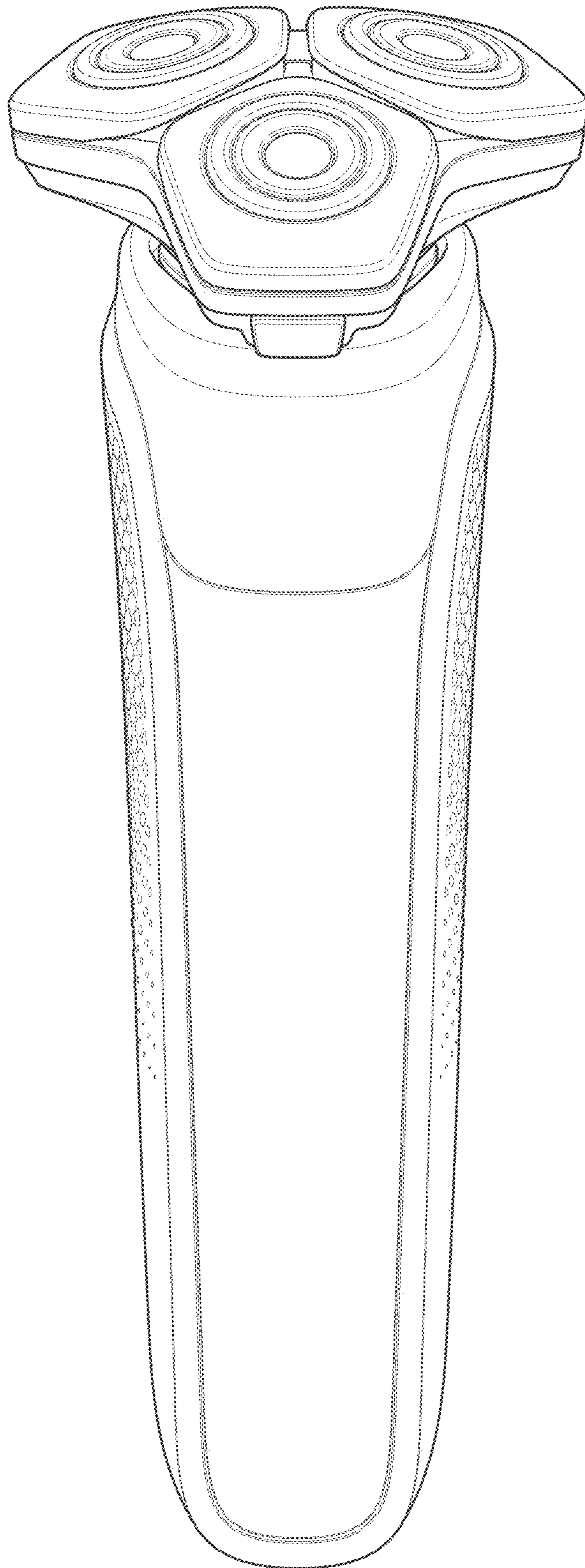

FIG. 23

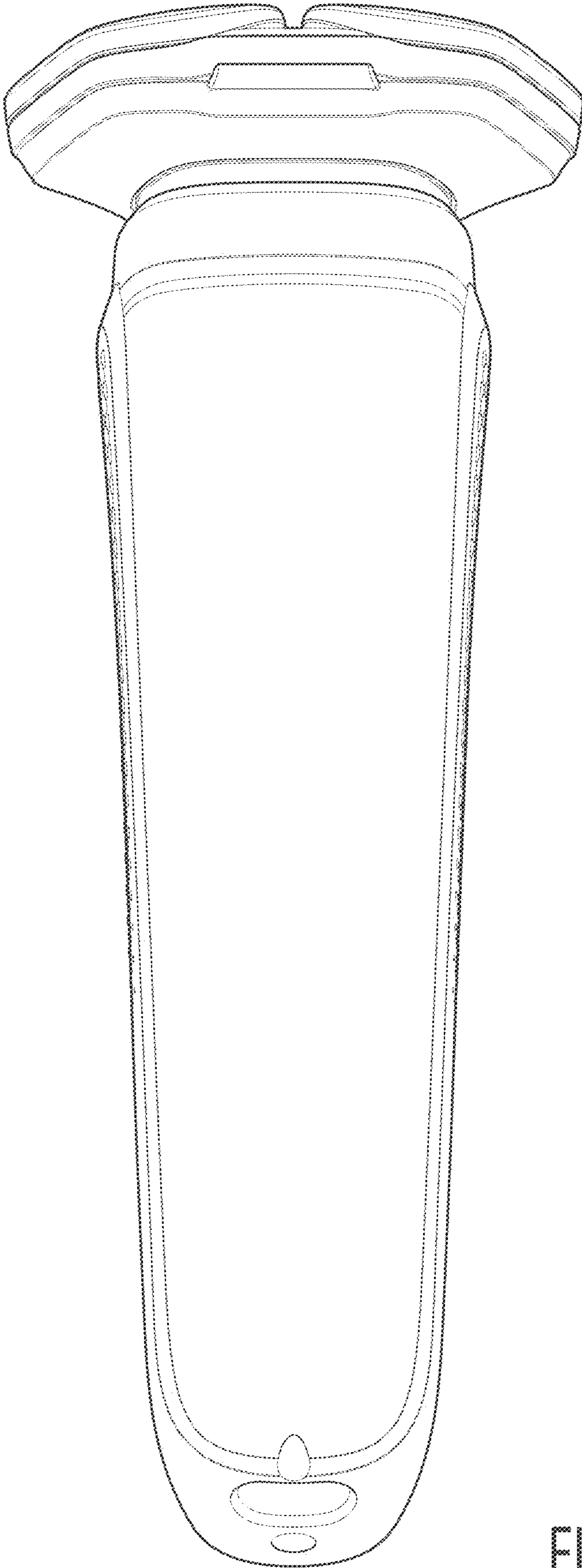

FIG. 24

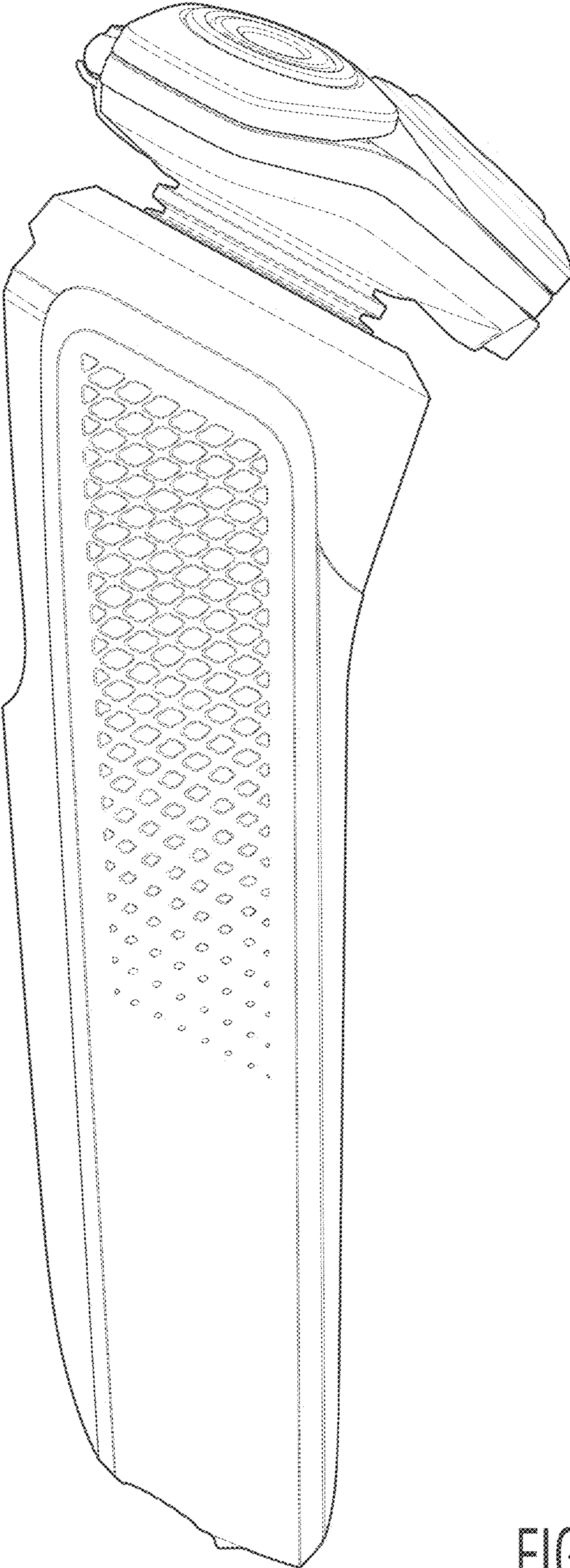

FIG. 25



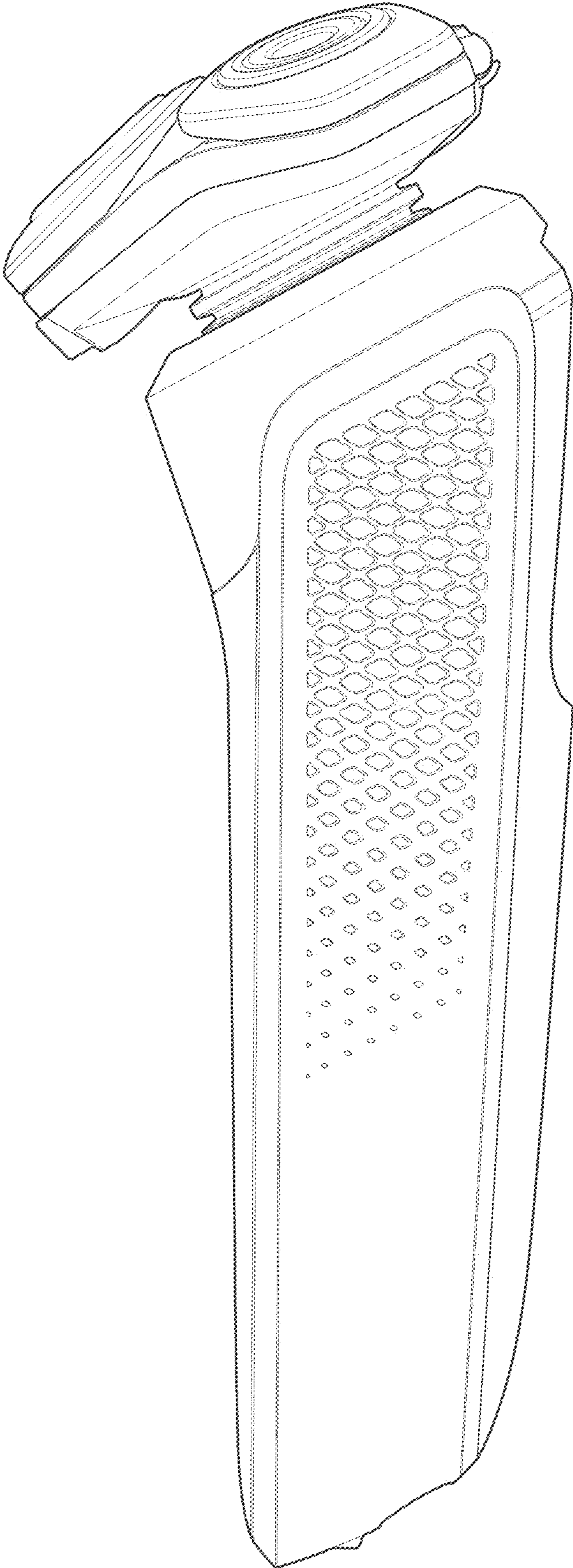

FIG. 26

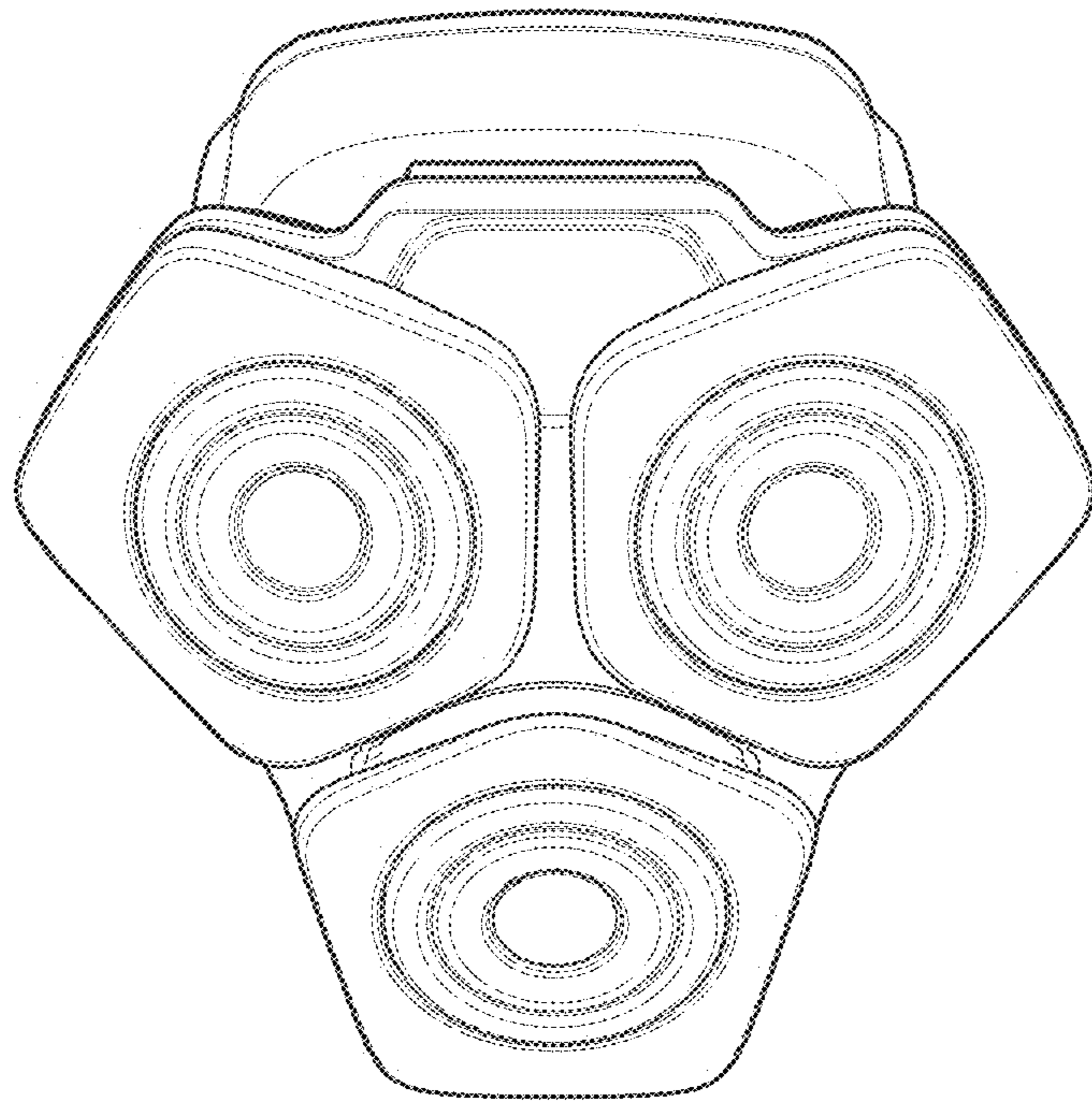

FIG. 27

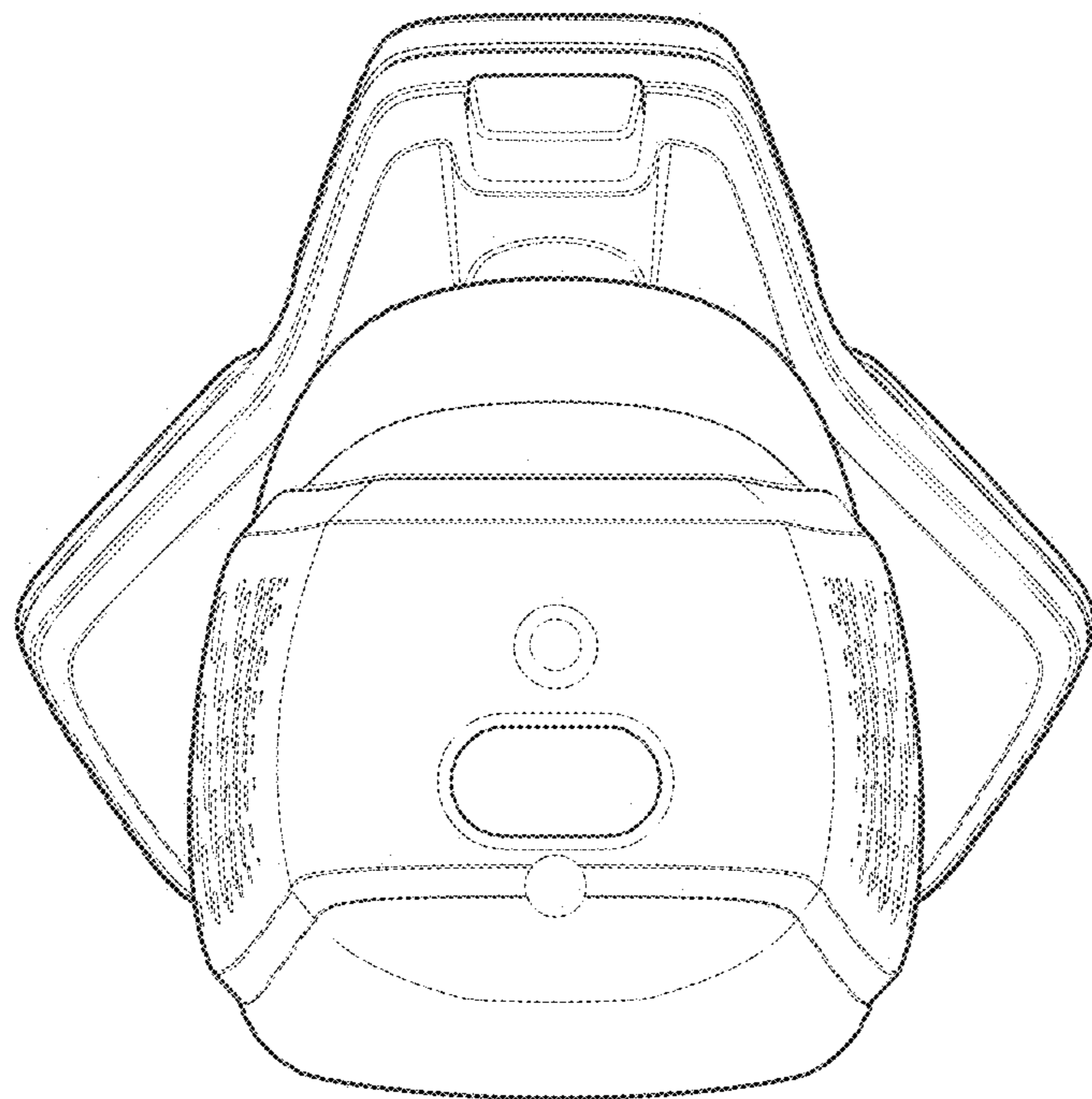

FIG. 28

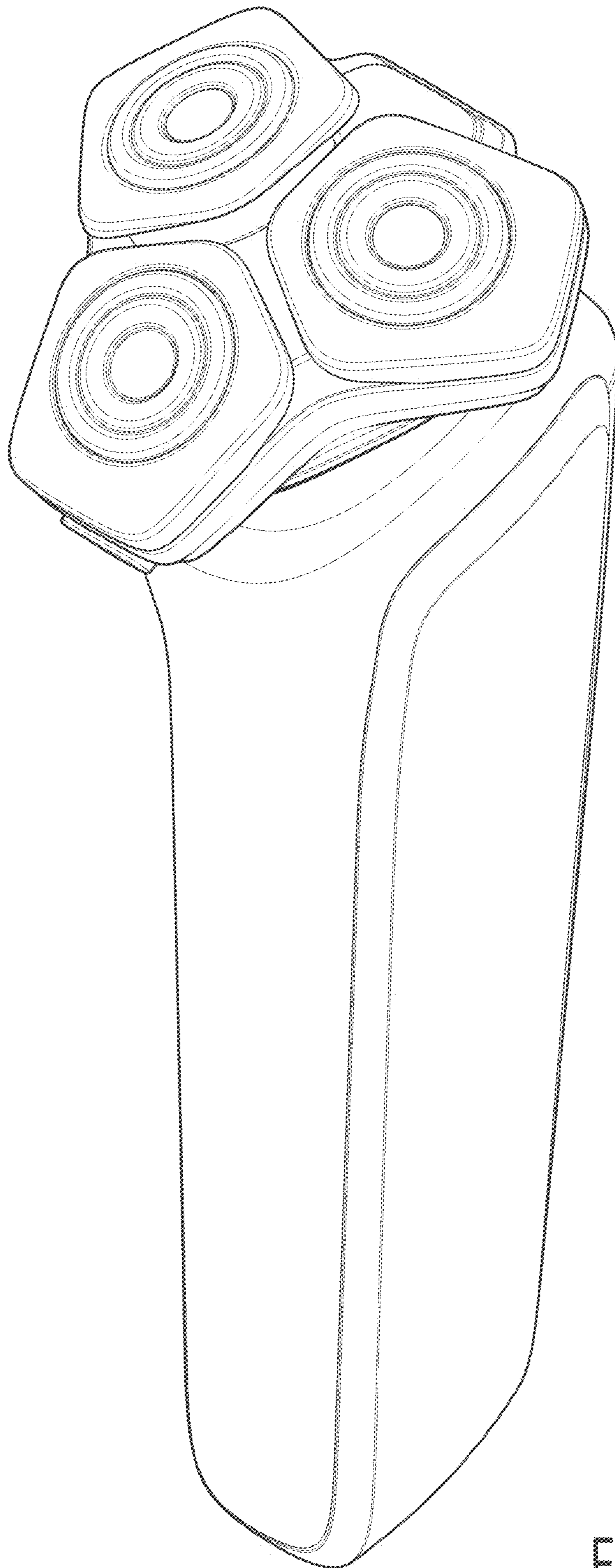

FIG. 29

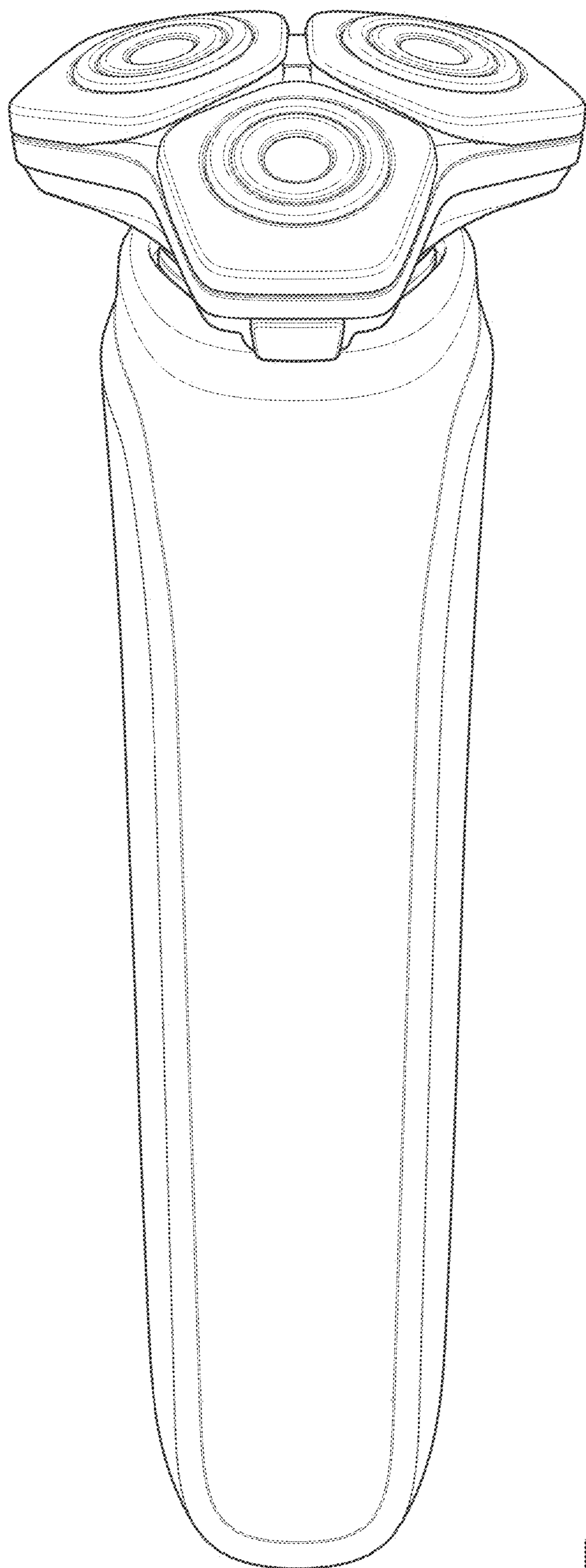

FIG. 30

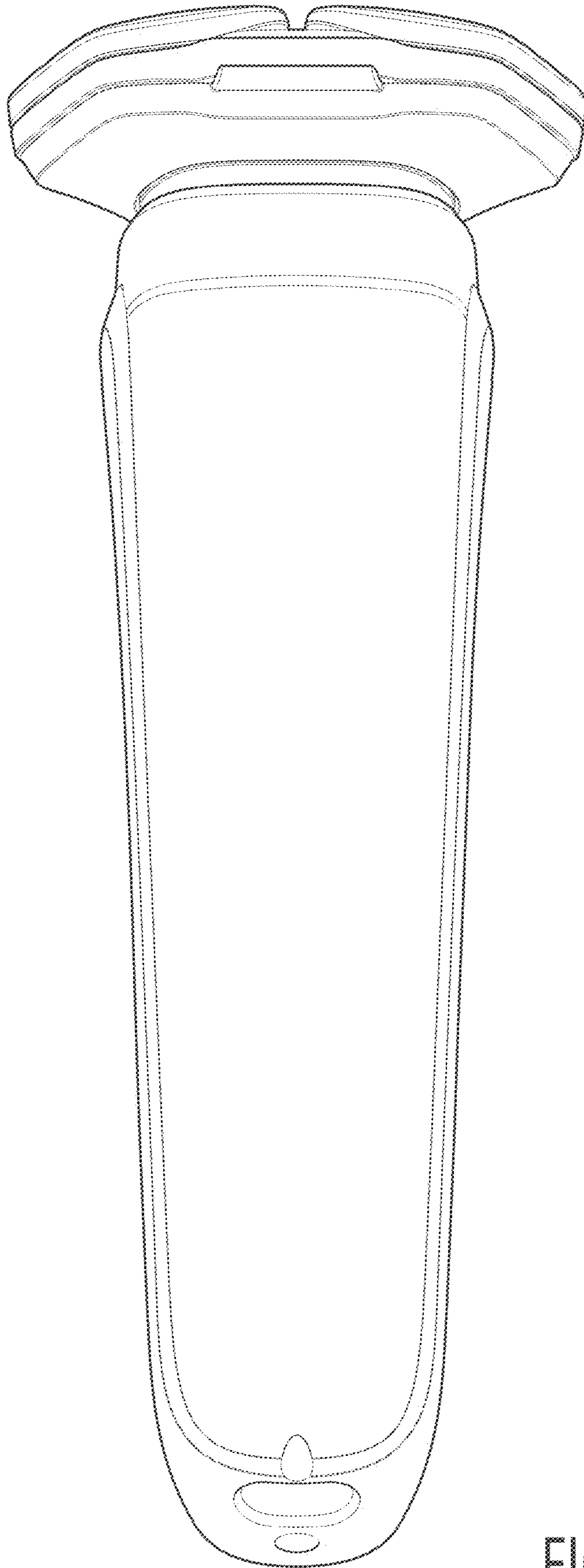

FIG. 31

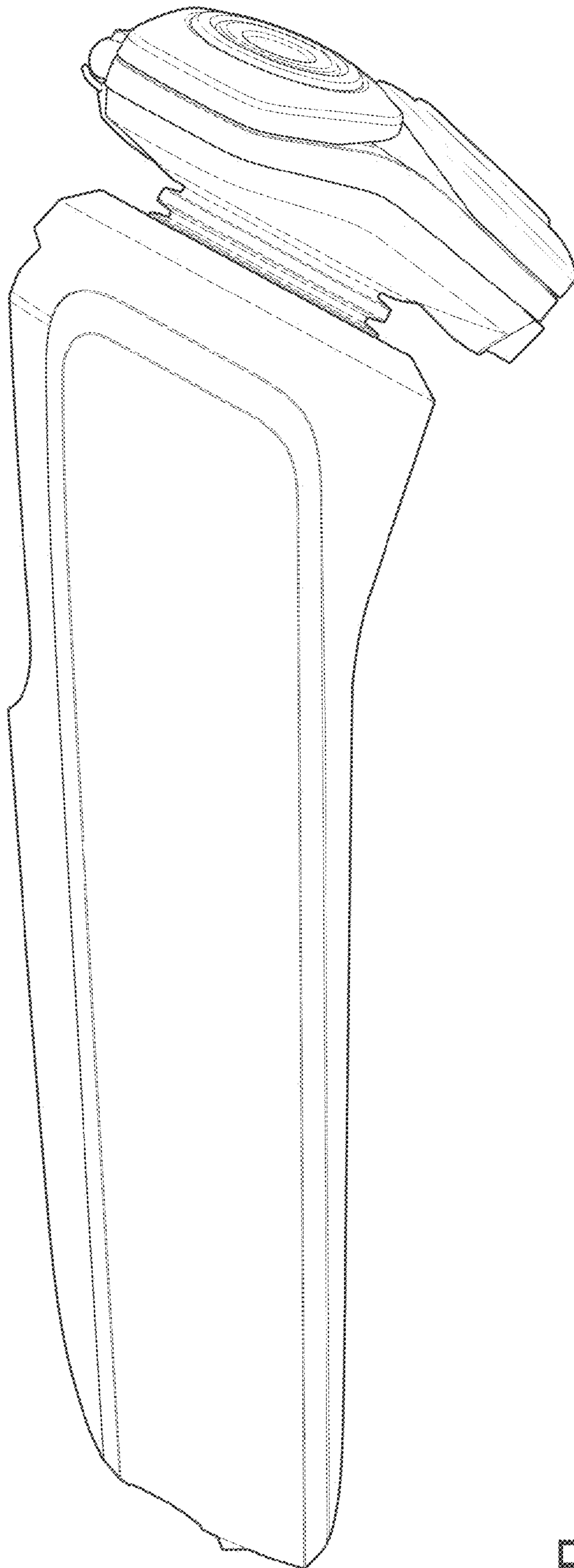

FIG. 32

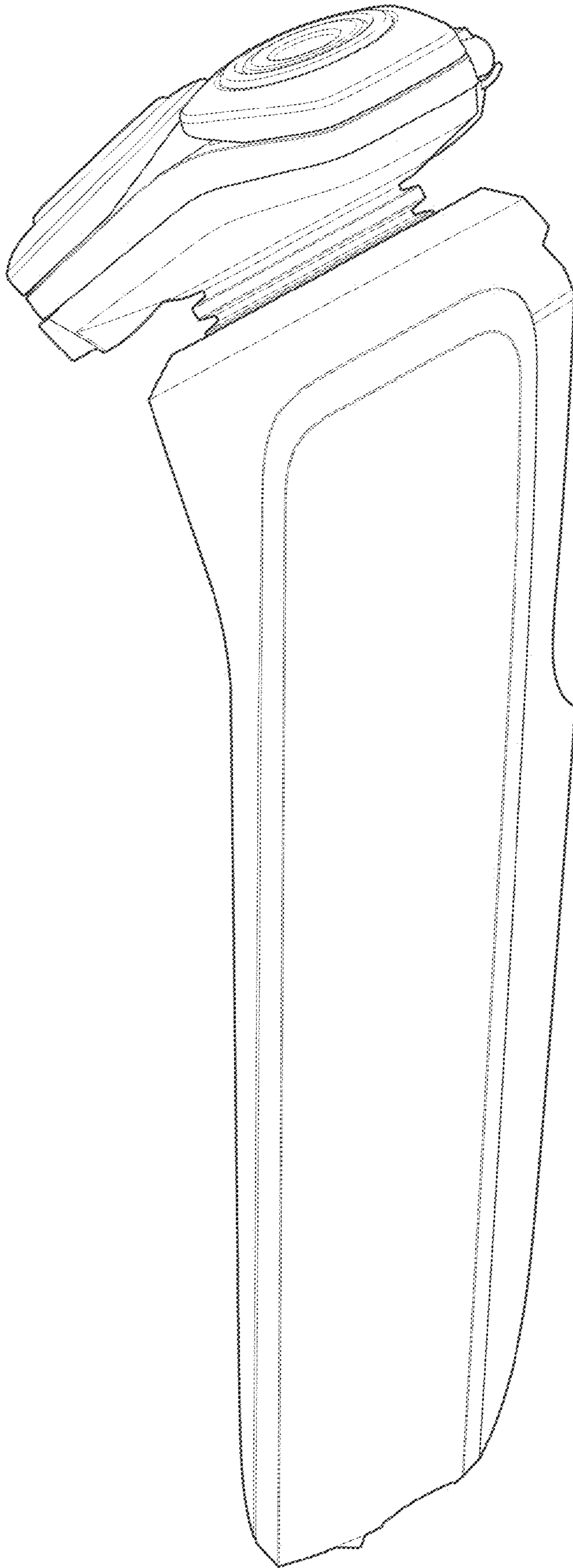

FIG. 33

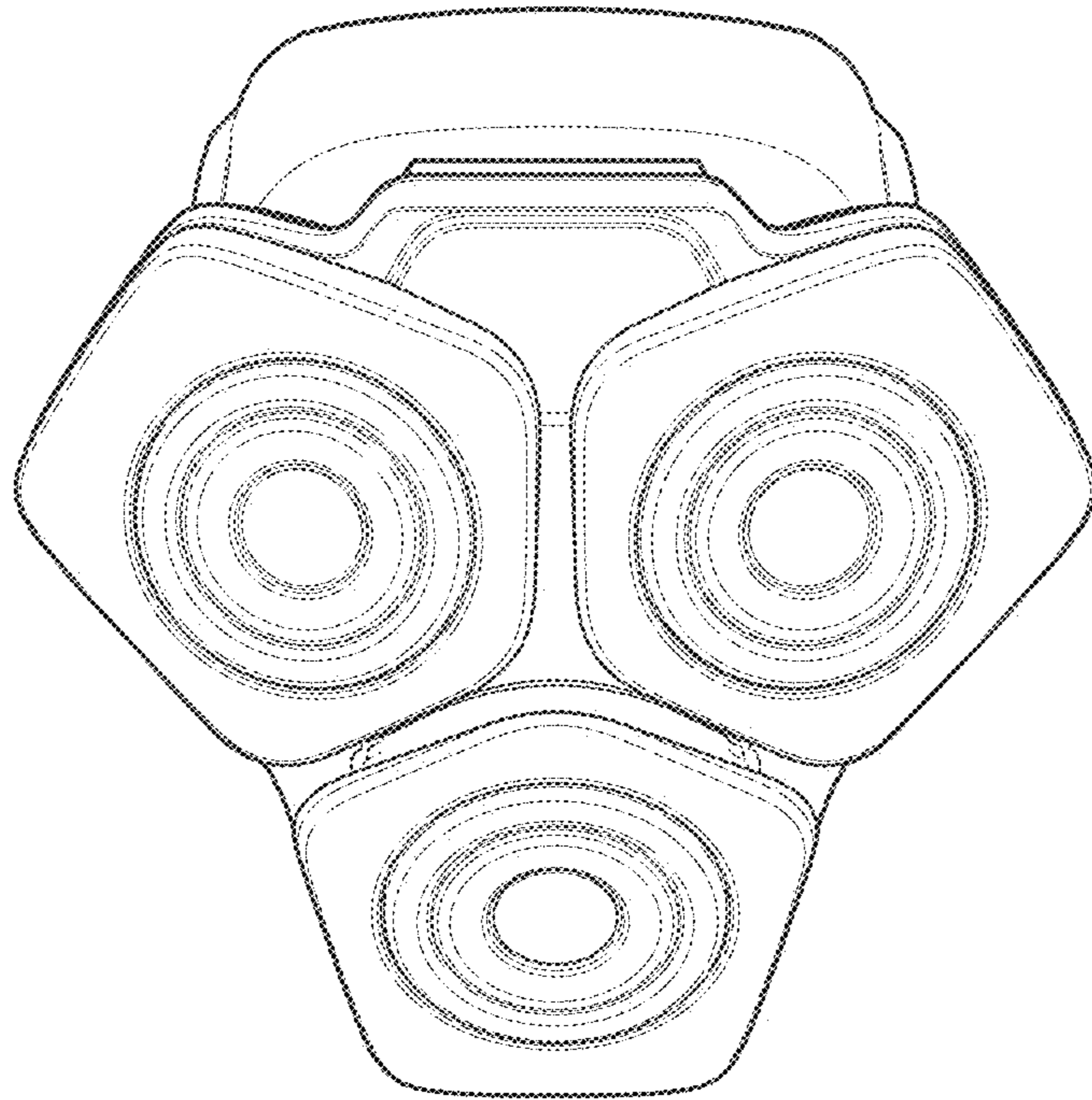

FIG. 34

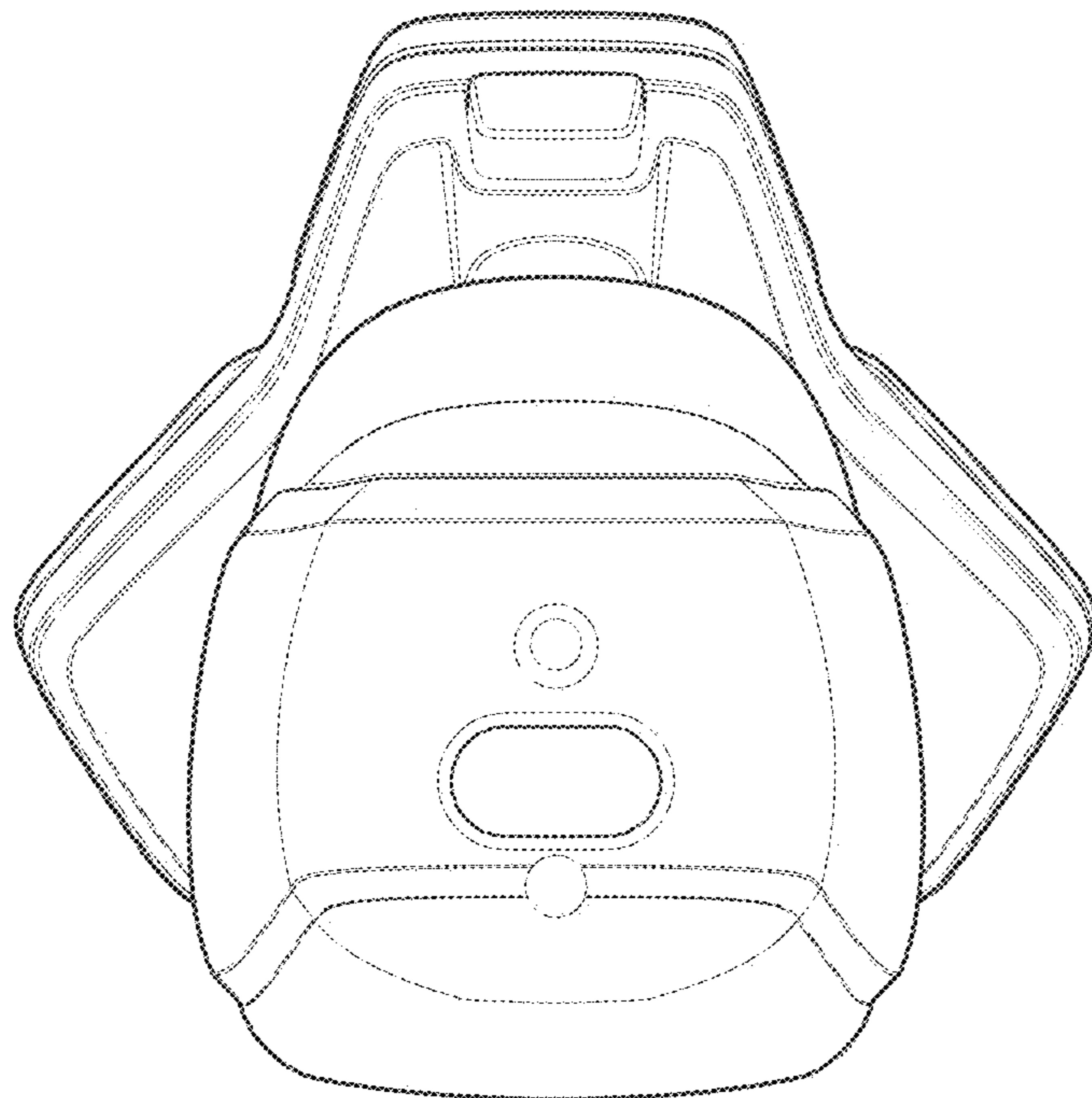

FIG. 35



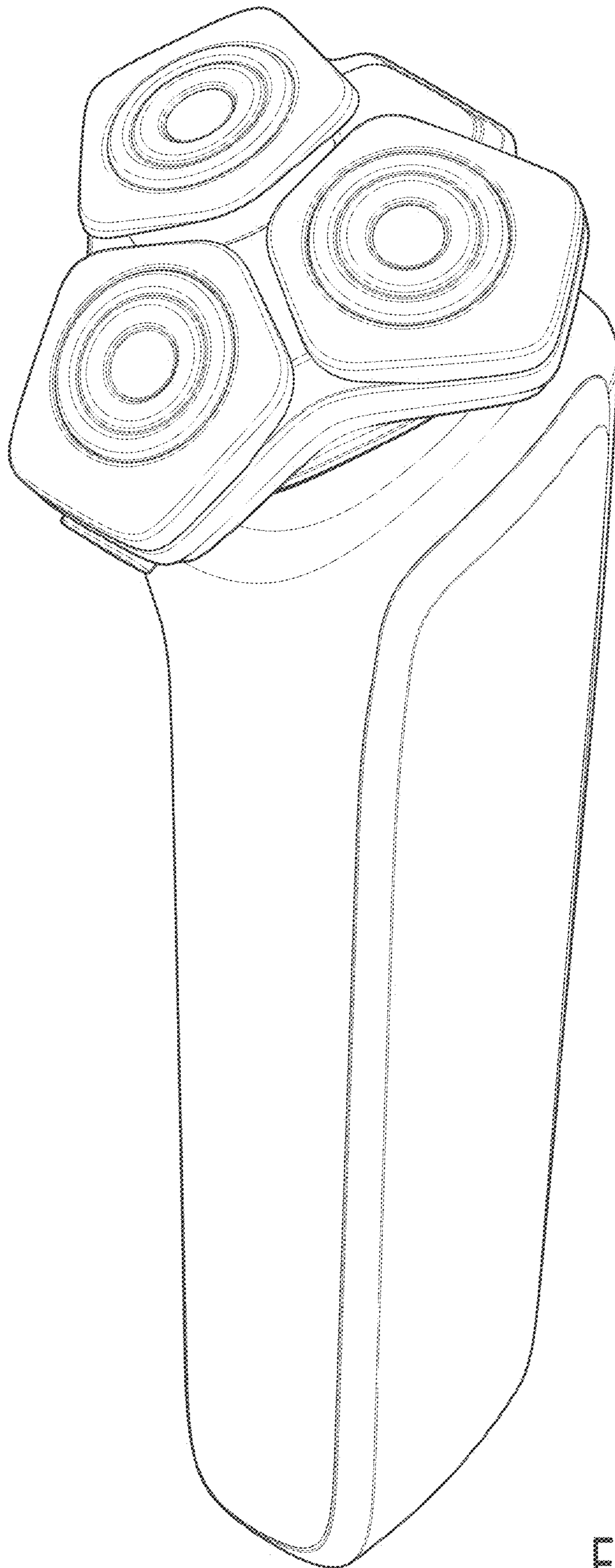

FIG. 36

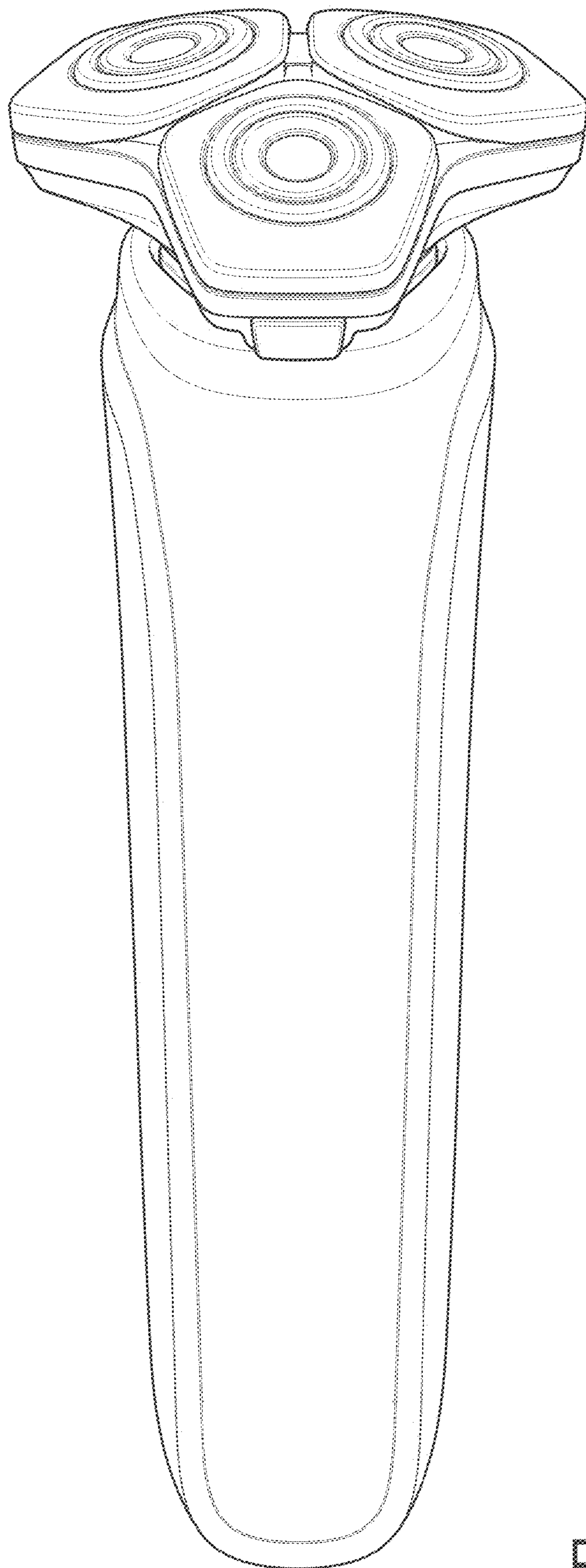

FIG. 37

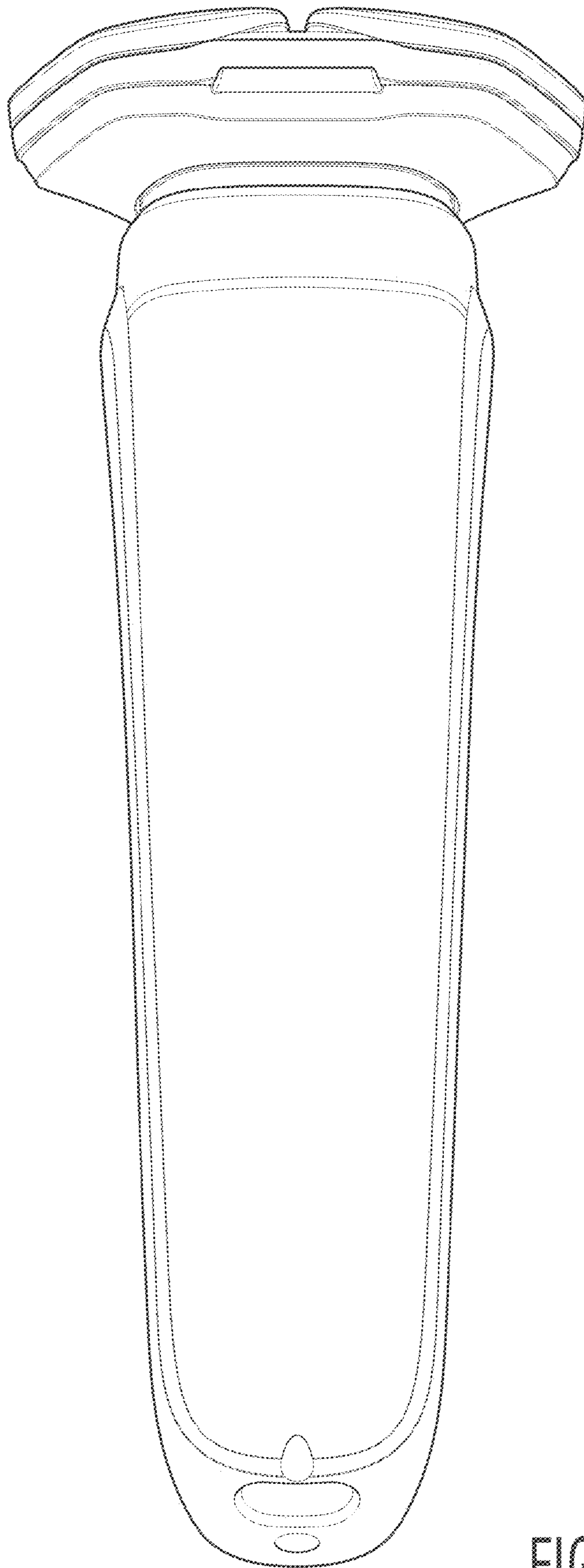

FIG. 38

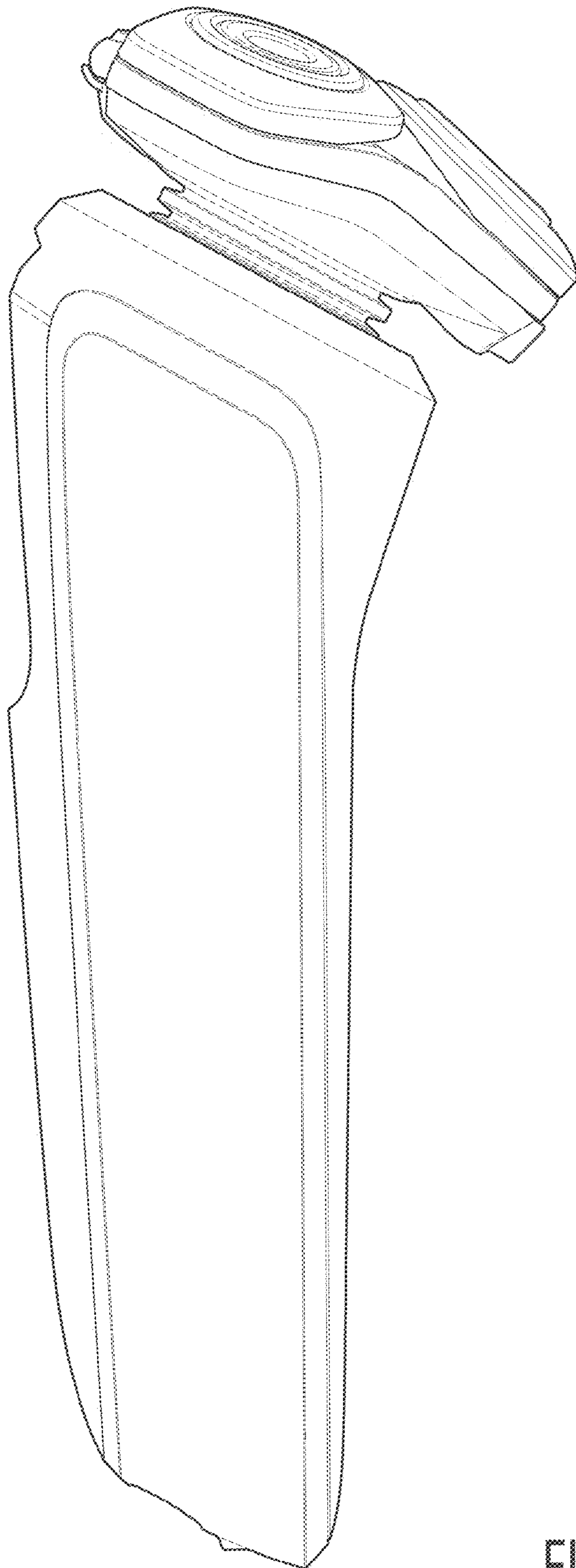

FIG. 39

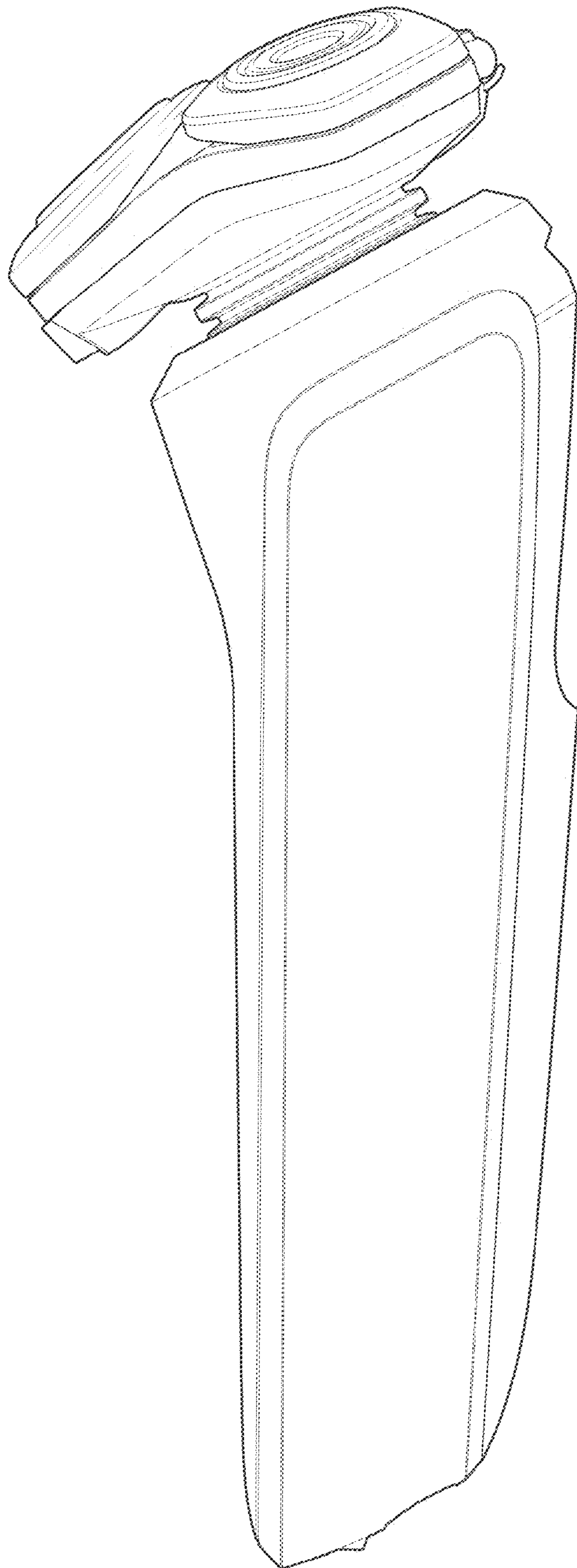

FIG. 40

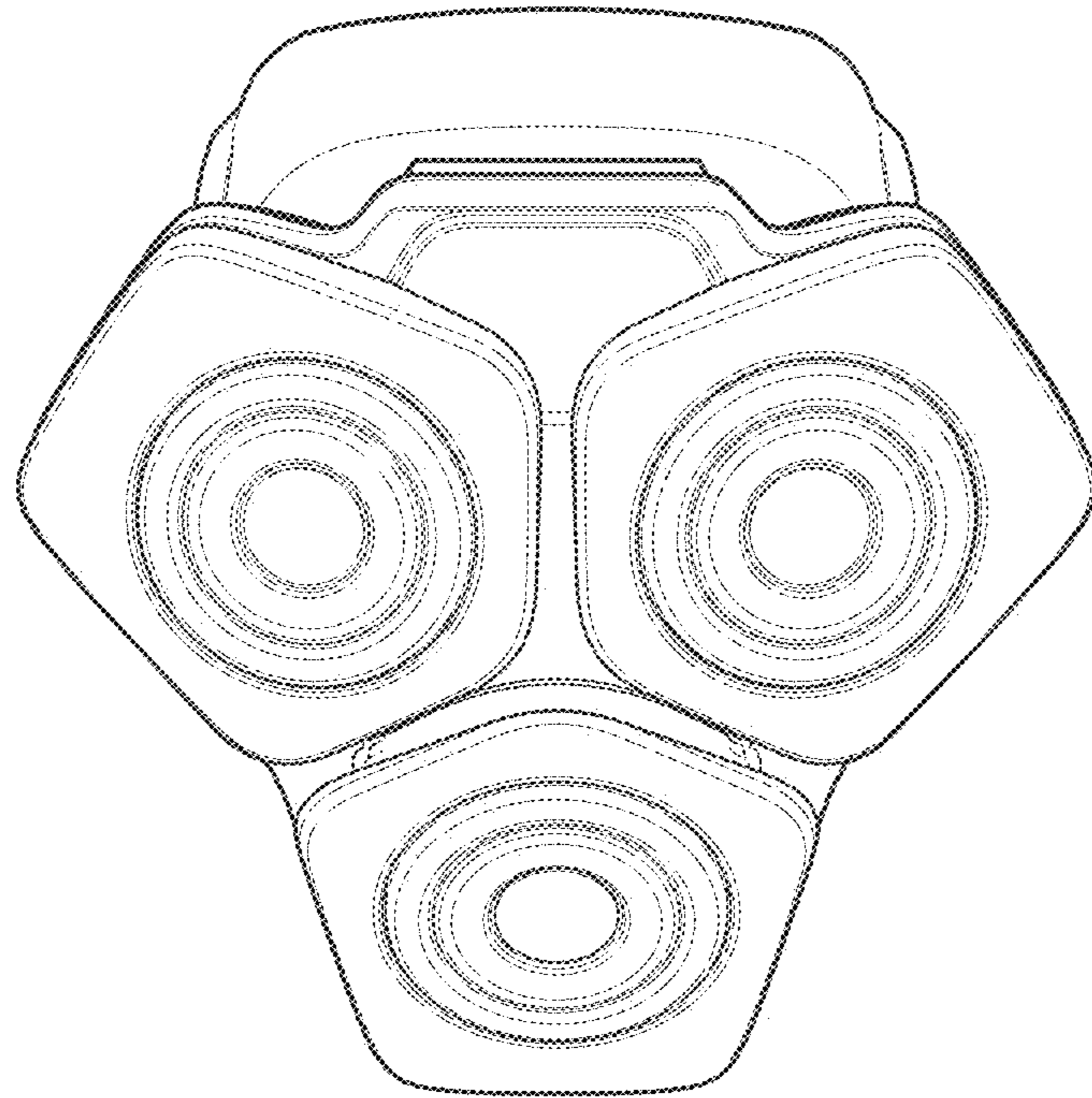

FIG. 41

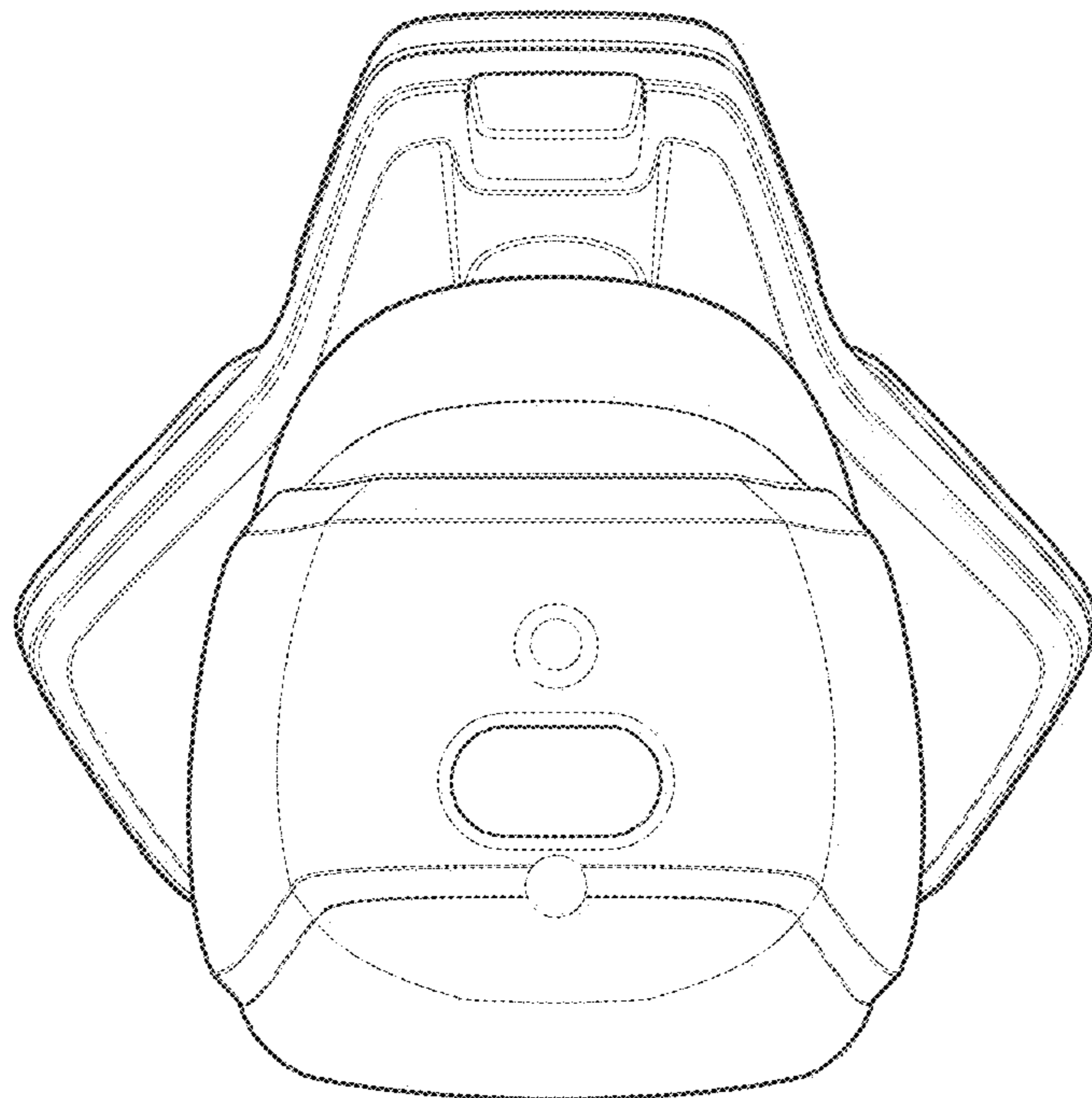

FIG. 42