



US00D933819S

(12) **United States Design Patent** (10) **Patent No.:** **US D933,819 S**  
**Sweitzer et al.** (45) **Date of Patent:** **\*\* Oct. 19, 2021**

(54) **JAW FOR A SURGICAL INSTRUMENT**  
(71) Applicants: **Shukla Medical**, St. Petersburg, FL (US); **The Regents of the University of Colorado**, a body corporate, Denver, CO (US)  
(72) Inventors: **Zachary Robert Sweitzer**, Keyport, NJ (US); **Jonathan Todd Bravman**, Golden, CO (US)  
(73) Assignees: **Shukla Medical**, St. Petersburg, FL (US); **The Regents of the University of Colorado**, a body corporate, Denver, CO (US)

D257,810 S \* 1/1981 Wilson ..... D6/556  
D263,714 S \* 4/1982 Treloar ..... D15/140  
D272,125 S \* 1/1984 Van Doren ..... D8/356  
D275,451 S \* 9/1984 Galloway ..... D8/396  
D276,134 S \* 10/1984 Ericsson ..... D8/396  
D284,832 S \* 7/1986 Parker ..... D8/380  
D296,417 S \* 6/1988 Misono ..... 248/74.2  
D296,983 S \* 8/1988 Westerlund ..... D8/391  
D306,032 S \* 2/1990 Mihic ..... 407/116

(Continued)

*Primary Examiner* — T Chase Nelson  
*Assistant Examiner* — Kelly L Gross  
(74) *Attorney, Agent, or Firm* — Kim IP Law Group LLC

(\*\*) Term: **15 Years**  
(21) Appl. No.: **29/708,248**  
(22) Filed: **Oct. 4, 2019**  
(51) **LOC (13) Cl.** ..... **24-02**  
(52) **U.S. Cl.**  
USPC ..... **D24/133**  
(58) **Field of Classification Search**  
USPC ..... D24/133, 128, 135, 155, 159, 183, 184, D24/190; D15/140, 138; D8/71, 74, D8/321, 380, 382, 349, 394, 499; D3/312, 313  
CPC ... A61B 2017/0287; B25B 9/00; B25B 11/00; B25B 23/00; B25B 23/0007; B25B 23/0057; B25B 23/0085; B25B 33/00; A47F 5/0869; Y10S 269/00; Y10T 16/00; Y10T 16/211; Y10T 279/00; Y10T 279/17196; Y10T 279/17752; F16M 2200/066; F16M 100/00; F16M 13/00; F16M 13/005; F16M 13/04; F16M 11/02  
See application file for complete search history.

(57) **CLAIM**

The ornamental design for a jaw for a surgical instrument, as shown and described.

**DESCRIPTION**

FIG. 1 is a perspective view of a jaw for a surgical instrument in accordance with the new design;  
FIG. 2 is a front view of the jaw for a surgical instrument of FIG. 1;  
FIG. 3 is a rear view of the jaw for a surgical instrument of FIG. 1;  
FIG. 4 is a right side view of the jaw for a surgical instrument of FIG. 1;  
FIG. 5 is a left side view of the jaw for a surgical instrument of FIG. 1;  
FIG. 6 is a top plan view of the jaw for a surgical instrument of FIG. 1; and,  
FIG. 7 is a bottom plan view of the jaw for a surgical instrument of FIG. 1.  
The even length broken lines in the figures are directed to portions of the jaw for a surgical instrument that form no part of the claimed design. The dot-dashed lines show unclaimed boundaries and form no part of the claimed design.

(56) **References Cited**  
U.S. PATENT DOCUMENTS

D252,070 S \* 6/1979 Schindele ..... D25/38.1  
D253,090 S \* 10/1979 Sharley ..... D8/354

**1 Claim, 6 Drawing Sheets**

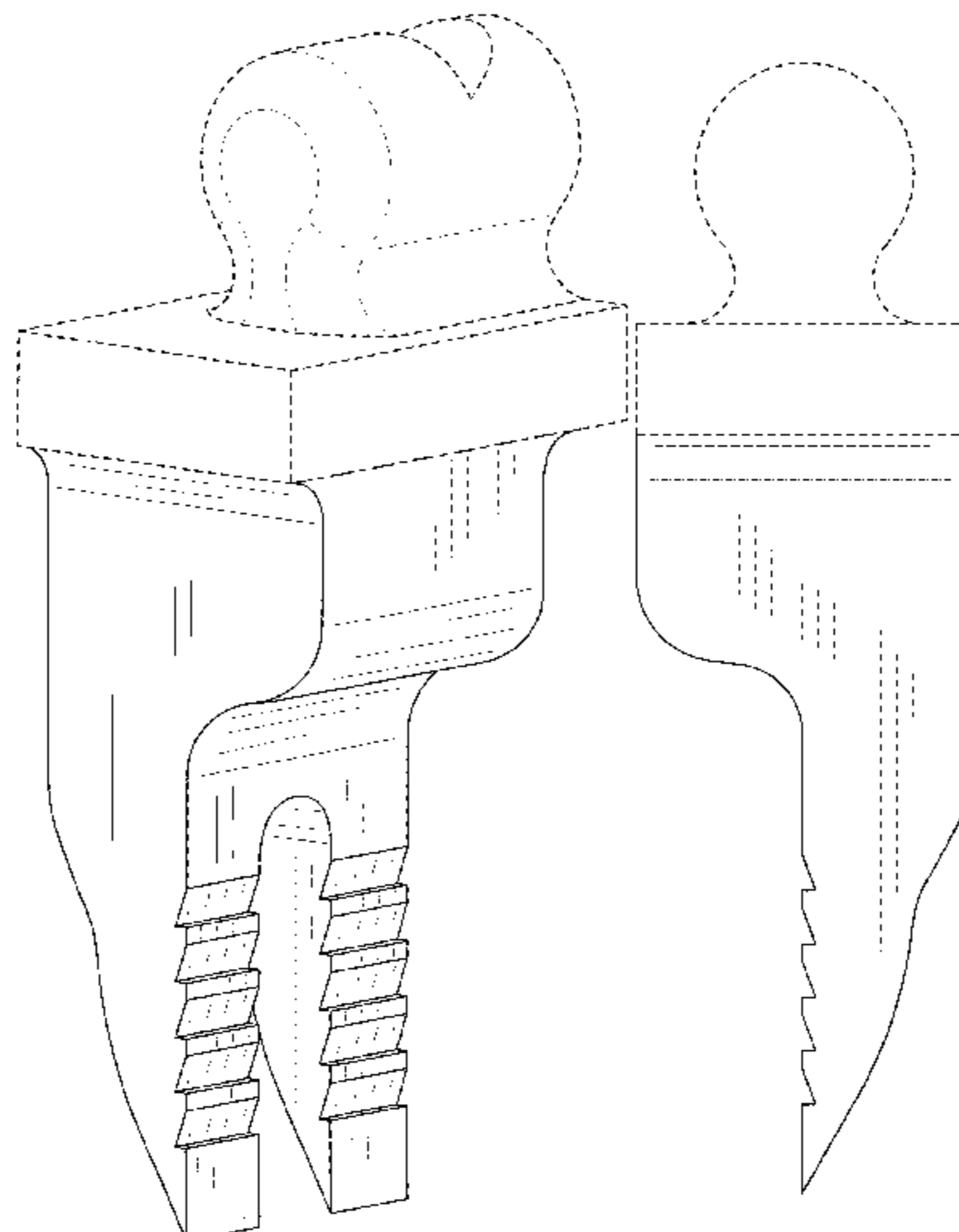

(56)

## References Cited

## U.S. PATENT DOCUMENTS

D350,307 S *	9/1994	Willis	428/28	D657,664 S *	4/2012	Boucher-Gagne	D8/394
D350,308 S *	9/1994	Willis	428/28	D658,048 S *	4/2012	Boucher-Gagne	D8/394
D350,309 S *	9/1994	Willis	428/28	D658,049 S *	4/2012	Boucher-Gagne	D8/394
D350,310 S *	9/1994	Willis	428/28	D658,050 S *	4/2012	Boucher-Gagne	D8/394
D374,607 S *	10/1996	Shoda	D8/382	D658,051 S *	4/2012	Boucher-Gagne	D8/394
D374,608 S *	10/1996	Shoda	D8/382	D658,052 S *	4/2012	Boucher-Gagne	D8/394
D374,611 S *	10/1996	Bonoan	401/104	D658,285 S *	4/2012	Ryshkus	D24/135
D376,756 S *	12/1996	Adams	D8/382	D658,286 S *	4/2012	Ryshkus	D24/135
D379,630 S *	6/1997	Brockway	D15/29	D658,287 S *	4/2012	Ryshkus	D24/135
D386,364 S *	11/1997	Rimback	D8/1	D658,761 S *	5/2012	Brotman	D24/155
D391,843 S *	3/1998	Glickman	D8/382	D659,525 S *	5/2012	Boucher-Gagne	D8/394
D392,553 S *	3/1998	Dill	D8/380	D659,526 S *	5/2012	Boucher-Gagne	D8/395
D393,417 S *	4/1998	Glickman	D8/382	D659,527 S *	5/2012	Boucher-Gagne	D8/395
D404,285 S *	1/1999	Skudelny	D8/354	D664,929 S *	8/2012	Saber	D13/154
D407,301 S *	3/1999	Donalies	D8/382	D666,937 S *	9/2012	Dunn	D11/184
D443,503 S *	6/2001	Harvey	D8/367	D676,071 S *	2/2013	Cox	D15/139
D471,925 S *	3/2003	Duginske	D15/140	D677,386 S *	3/2013	Bisleri	D24/148
D486,503 S *	2/2004	East	D15/133	D680,654 S *	4/2013	Borreli	D24/188
D522,348 S *	6/2006	Hansen	D8/354	D685,088 S *	6/2013	Yaremchuk	D24/143
D527,400 S *	8/2006	Konet	D15/139	D687,684 S *	8/2013	Olson	D8/8
D527,750 S *	9/2006	Prince	D15/138	D691,027 S *	10/2013	Rainer	D8/356
D529,521 S *	10/2006	Prince	D15/138	D691,721 S *	10/2013	Scheibel	D24/146
D529,524 S *	10/2006	Duncan	D15/138	D692,935 S *	11/2013	Meier	D15/123
D534,417 S *	1/2007	Caruana	D8/382	D693,381 S *	11/2013	Meier	D15/123
D534,934 S *	1/2007	Bernhardt	D15/140	D693,382 S *	11/2013	Meier	D15/123
D544,004 S *	6/2007	Janness	D15/139	D693,383 S *	11/2013	Meier	D15/123
D548,416 S *	8/2007	Gullicks	D32/42	D698,235 S *	1/2014	Oetlinger	D8/397
D548,571 S *	8/2007	Bigelow	D8/349	D700,829 S *	3/2014	Nanbu	D8/367
D556,531 S *	12/2007	Allen	D8/72	D706,322 S *	6/2014	Monttinen	D15/139
D567,832 S *	4/2008	Edwards	D15/139	D708,738 S *	7/2014	Berman	D24/112
D572,735 S *	7/2008	Kammerer	D15/139	D712,473 S *	9/2014	Andochick	D19/81
D574,400 S *	8/2008	Willibald	D15/123	D712,487 S *	9/2014	Strand	D21/484
D576,464 S *	9/2008	Franks, Jr.	D8/72	D712,488 S *	9/2014	Strand	D21/484
D590,944 S *	4/2009	Watanabe	D24/143	D714,374 S *	9/2014	Sammons	D16/237
D595,322 S *	6/2009	Sakata	D15/139	D714,621 S *	10/2014	Pan	D8/367
D595,323 S *	6/2009	Sakata	D15/139	D719,655 S *	12/2014	Lim	D24/153
D595,751 S *	7/2009	Sakata	D15/139	D720,072 S *	12/2014	Cheney	D24/155
D597,393 S *	8/2009	Klippel	D8/72	D721,785 S *	1/2015	Gehrunge	D23/226
D599,479 S *	9/2009	Petersen	D24/133	D722,864 S *	2/2015	Greenthal	D8/382
D620,109 S *	7/2010	Darst Rice	D24/146	D722,865 S *	2/2015	Greenthal	D8/382
D623,929 S *	9/2010	Jarvis	D8/381	D727,138 S *	4/2015	Cross	D8/382
D625,806 S *	10/2010	Leroy	D24/143	D734,852 S *	7/2015	Lim	D24/153
D625,807 S *	10/2010	Leroy	D24/143	D737,442 S *	8/2015	Hasebe	D24/146
D625,808 S *	10/2010	Leroy	D24/143	D742,720 S *	11/2015	Perry	D8/349
D625,809 S *	10/2010	Cuschieri	D24/143	D747,803 S *	1/2016	Knight	D24/140
D625,984 S *	10/2010	McGrath	D8/355	D749,730 S *	2/2016	Dietz	D24/146
D625,986 S *	10/2010	Kolasa	D8/356	D752,740 S *	3/2016	Price	D24/129
D626,225 S *	10/2010	Dapri	D24/143	D754,949 S *	5/2016	Lu	D2/864
D626,226 S *	10/2010	Carus	D24/143	D760,580 S *	7/2016	Pace	D8/382
D626,227 S *	10/2010	Leroy	D24/143	D761,953 S *	7/2016	Eisele	D24/113
D626,228 S *	10/2010	Leroy	D24/143	D764,053 S *	8/2016	Stonig	D24/127
D626,229 S *	10/2010	Leroy	D24/143	D765,156 S *	8/2016	Matsumoto	D15/138
D627,462 S *	11/2010	Kingsley	D24/144	D767,350 S *	9/2016	Bober	D8/14
D629,902 S *	12/2010	Palmer	D24/146	D767,761 S *	9/2016	Babb	D24/143
D631,493 S *	1/2011	Tanaka	D15/139	D768,471 S *	10/2016	Marquez	D8/382
D633,614 S *	3/2011	Mao	D24/135	D768,855 S *	10/2016	McMillan	D24/143
D636,661 S *	4/2011	Marmas	D8/395	D772,373 S *	11/2016	Calbi	D22/199
D638,041 S *	5/2011	Saito	D15/139	D772,399 S *	11/2016	Beechie	D24/119
D638,280 S *	5/2011	Mcalonan	D8/349	D773,388 S *	12/2016	Sweeney	D13/102
D638,453 S *	5/2011	Buhr	D15/140	D773,663 S *	12/2016	Miyagi	D24/143
D640,790 S *	6/2011	Nishimura	D24/146	D774,191 S *	12/2016	Miyagi	D24/143
D641,872 S *	7/2011	Solingen	D24/143	D776,025 S *	1/2017	Tsai	D12/179
D641,873 S *	7/2011	Solingen	D24/143	D776,276 S *	1/2017	Witt	D24/146
D641,874 S *	7/2011	Solingen	D24/143	D778,446 S *	2/2017	Kumar	D24/171
D643,281 S *	8/2011	Roberts	D8/394	D783,166 S *	4/2017	Champ	D24/147
D643,925 S *	8/2011	Vaidya	A61B 17/7035	D784,531 S *	4/2017	Malcolm	D24/135
			D24/155	D788,917 S *	6/2017	Lautemann	D24/143
D644,920 S *	9/2011	Price	D8/395	D788,919 S *	6/2017	Lautemann	D24/143
D647,116 S *	10/2011	Omi	D15/139	D788,920 S *	6/2017	Lautemann	D24/143
D647,117 S *	10/2011	Omi	D15/139	D789,530 S *	6/2017	Casey	A61B 17/863
D648,850 S *	11/2011	Kelman	A61B 17/164				D24/135
			D24/133	D791,321 S *	7/2017	Wittner	D24/146
D652,924 S *	1/2012	Noshiro	D24/143	D792,587 S *	7/2017	Owens	D24/133
D657,662 S *	4/2012	Boucher-Gagne	D8/394	D793,828 S *	8/2017	Askin	D8/47
D657,663 S *	4/2012	Boucher-Gagne	D8/394	D796,039 S *	8/2017	McMillan	D24/143
				D796,666 S *	9/2017	Beechie	D24/119
				D800,903 S *	10/2017	Heiliger	D24/144
				D801,533 S *	10/2017	Slater	D24/171
				D808,780 S *	1/2018	Kim	D8/367

(56)

References Cited

U.S. PATENT DOCUMENTS

D809,028 S \* 1/2018 Imahase ..... D15/135  
 D809,207 S \* 1/2018 Hussain ..... D28/55  
 D814,031 S \* 3/2018 Radpour ..... D24/141  
 D816,548 S \* 5/2018 Soylemez ..... D12/51  
 D819,815 S \* 6/2018 Goodman ..... D24/144  
 D823,155 S \* 7/2018 Allen ..... D11/87  
 D823,970 S \* 7/2018 Choma ..... D22/107  
 D824,026 S \* 7/2018 Eaton ..... D24/128  
 D825,755 S \* 8/2018 Pfeffer ..... D24/143  
 D827,133 S \* 8/2018 Gro er ..... D24/130  
 D828,554 S \* 9/2018 Goodman ..... D24/144  
 D828,558 S \* 9/2018 Haerle ..... D24/146  
 D831,571 S \* 10/2018 Eberts ..... H01H 71/08  
 D831,827 S \* 10/2018 Kohler ..... D13/119  
 D832,441 S \* 10/2018 Dacosta ..... D24/152  
 D832,441 S \* 10/2018 Dacosta ..... D24/155  
 10,099,358 B2 \* 10/2018 McMillan ..... A61B 17/92  
 D833,613 S \* 11/2018 Grotz ..... D24/155  
 D834,188 S \* 11/2018 Alexander ..... D24/135  
 D834,715 S \* 11/2018 Alladu ..... D24/147  
 D836,197 S \* 12/2018 Cormio ..... D24/143  
 D837,377 S \* 1/2019 Steen ..... D24/154  
 D837,845 S \* 1/2019 Jones ..... D15/138  
 D838,847 S \* 1/2019 Zhang ..... D24/143  
 D840,999 S \* 2/2019 Hu ..... D14/253  
 D843,570 S \* 3/2019 Alladu ..... D24/140  
 D843,574 S \* 3/2019 Goodman ..... D24/144  
 D843,822 S \* 3/2019 Chappus ..... D8/380  
 D844,141 S \* 3/2019 Lautemann ..... D24/146  
 D844,143 S \* 3/2019 Muller ..... D24/152  
 D844,409 S \* 4/2019 Breeden, III ..... D8/303  
 D845,479 S \* 4/2019 Lautemann ..... D24/146  
 D845,480 S \* 4/2019 Lautemann ..... D24/146  
 D845,481 S \* 4/2019 Lautemann ..... D24/146  
 D845,482 S \* 4/2019 Lautemann ..... D24/146  
 D845,483 S \* 4/2019 Lautemann ..... D24/146  
 D846,119 S \* 4/2019 Greeley ..... D24/135  
 D846,803 S \* 4/2019 Thai ..... D28/57  
 D847,231 S \* 4/2019 Abe ..... D15/139  
 D847,370 S \* 4/2019 Paavilainen ..... D24/227  
 D850,614 S \* 6/2019 Eaton ..... D24/128  
 D852,245 S \* 6/2019 Kobayashi ..... D15/139  
 D852,246 S \* 6/2019 Kobayashi ..... D15/139  
 D852,308 S \* 6/2019 Ethridge ..... D22/108  
 D852,612 S \* 7/2019 Paik ..... D8/394  
 D857,197 S \* 8/2019 Loewe ..... D24/140  
 D857,470 S \* 8/2019 Corcoran ..... D8/14  
 D858,751 S \* 9/2019 Fischman ..... D24/112  
 D858,764 S \* 9/2019 Zimmerli ..... D24/137  
 D858,766 S \* 9/2019 Pfeffer ..... D24/143  
 D859,394 S \* 9/2019 Skogrand-Khatib ..... D14/253  
 D859,653 S \* 9/2019 Hartson ..... D24/135

D861,160 S \* 9/2019 Broyles ..... D24/127  
 D863,383 S \* 10/2019 Wills ..... D15/139  
 D865,826 S \* 11/2019 Hatano ..... D15/199  
 D866,282 S \* 11/2019 Ozeki ..... D8/71  
 D867,862 S \* 11/2019 Veilleux ..... D8/367  
 D871,897 S \* 1/2020 Wellington ..... D8/367  
 D875,928 S \* 2/2020 Zagatsky ..... D24/135  
 D877,328 S \* 3/2020 Alsiddiky ..... D24/135  
 D878,906 S \* 3/2020 Tung ..... D8/356  
 D879,688 S \* 3/2020 Ye ..... D12/182  
 D880,278 S \* 4/2020 Jaramillo ..... D8/354  
 D882,653 S \* 4/2020 Abe ..... D15/139  
 D882,793 S \* 4/2020 Qun ..... D24/146  
 D883,069 S \* 5/2020 Fannesbeck ..... D8/336  
 D886,222 S \* 6/2020 Griffiths ..... D21/797  
 D886,297 S \* 6/2020 Van Wyk ..... D24/143  
 D888,349 S \* 6/2020 Yoo ..... D30/158  
 D888,950 S \* 6/2020 Kuchta ..... D24/144  
 D889,646 S \* 7/2020 Bauer ..... D24/133  
 D894,385 S \* 8/2020 Giordano ..... D24/140  
 D895,797 S \* 9/2020 Brockmann ..... D24/133  
 D896,371 S \* 9/2020 Azapagic ..... D24/128  
 D898,192 S \* 10/2020 Sauer ..... D24/133  
 D898,909 S \* 10/2020 Sauer ..... D24/133  
 D898,914 S \* 10/2020 Niver ..... D24/147  
 D899,674 S \* 10/2020 He ..... D26/138  
 D900,581 S \* 11/2020 Su ..... D8/88  
 D901,687 S \* 11/2020 Chalk ..... D24/146  
 10,828,052 B2 \* 11/2020 Miller ..... A61B 17/244  
 D904,152 S \* 12/2020 Kukucka ..... D8/71  
 D904,842 S \* 12/2020 Hsieh ..... D8/29  
 D906,781 S \* 1/2021 Kukucka ..... D8/71  
 D907,152 S \* 1/2021 Windover ..... D21/782  
 D908,275 S \* 1/2021 Galli ..... D26/138  
 D909,437 S \* 2/2021 Sorai ..... D15/139  
 D910,093 S \* 2/2021 Abe ..... D15/139  
 D912,708 S \* 3/2021 Weinberg ..... D15/139  
 D913,084 S \* 3/2021 Nagaki ..... D8/394  
 D913,940 S \* 3/2021 Ishii ..... D13/121  
 D914,121 S \* 3/2021 McGowan ..... D21/774  
 D915,165 S \* 4/2021 Hsieh ..... D8/29  
 D915,185 S \* 4/2021 Benoit ..... D8/382  
 D916,279 S \* 4/2021 Rooks ..... A61B 90/57  
 D917,125 S \* 4/2021 Wood ..... D24/129  
 D917,125 S \* 4/2021 Wood ..... D34/35  
 D918,145 S \* 5/2021 Varjabedian ..... D13/118  
 D918,704 S \* 5/2021 Klotz ..... A61B 90/57  
 D918,704 S \* 5/2021 Klotz ..... D8/397  
 D919,799 S \* 5/2021 Zollinger ..... D24/129  
 D920,772 S \* 6/2021 McClung ..... D8/394  
 D921,887 S \* 6/2021 Hu ..... D24/128  
 D922,835 S \* 6/2021 Cao ..... D7/653  
 D922,931 S \* 6/2021 Badillo ..... D12/412  
 D923,178 S \* 6/2021 Abbasi ..... D24/155

\* cited by examiner

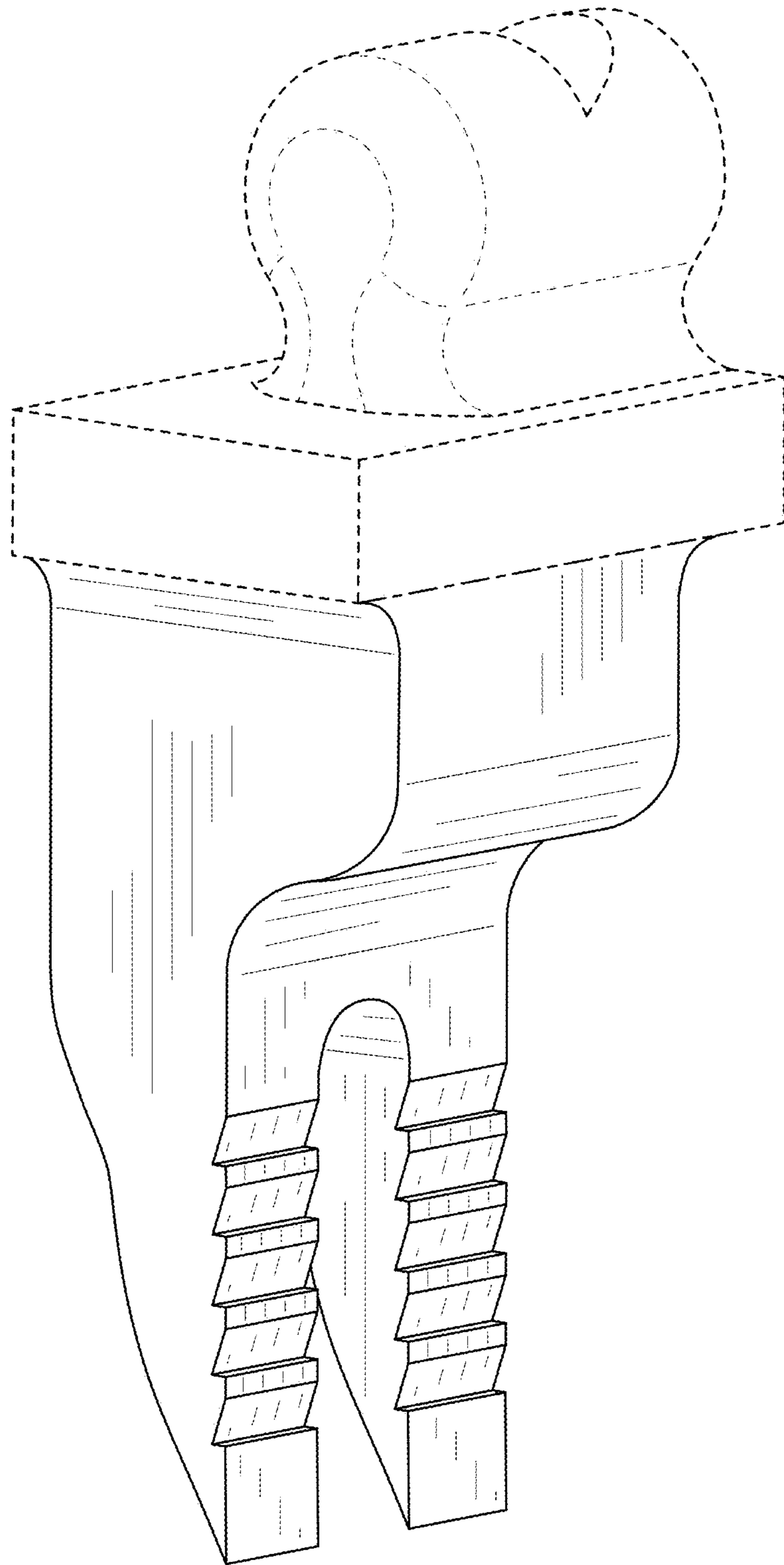

FIG. 1

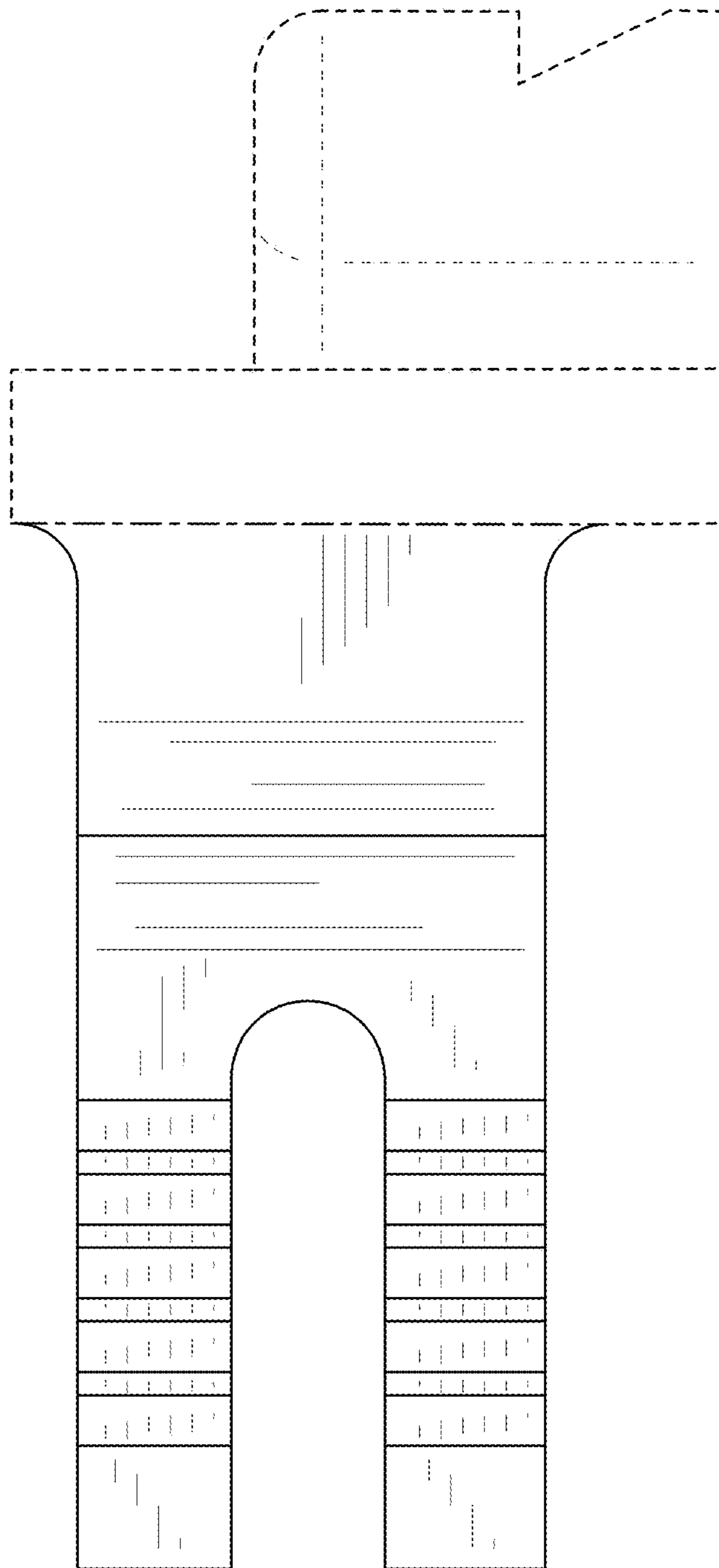

FIG. 2

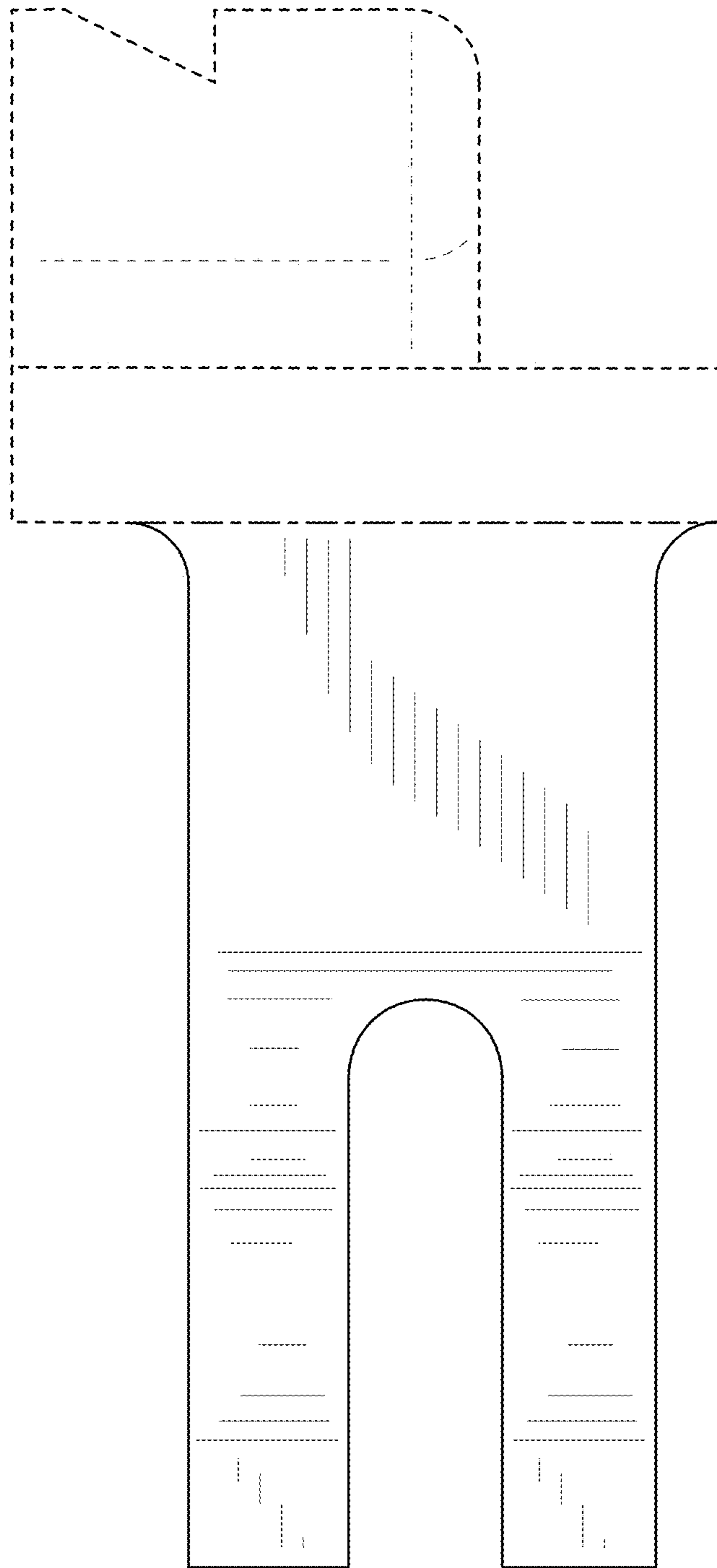

FIG. 3

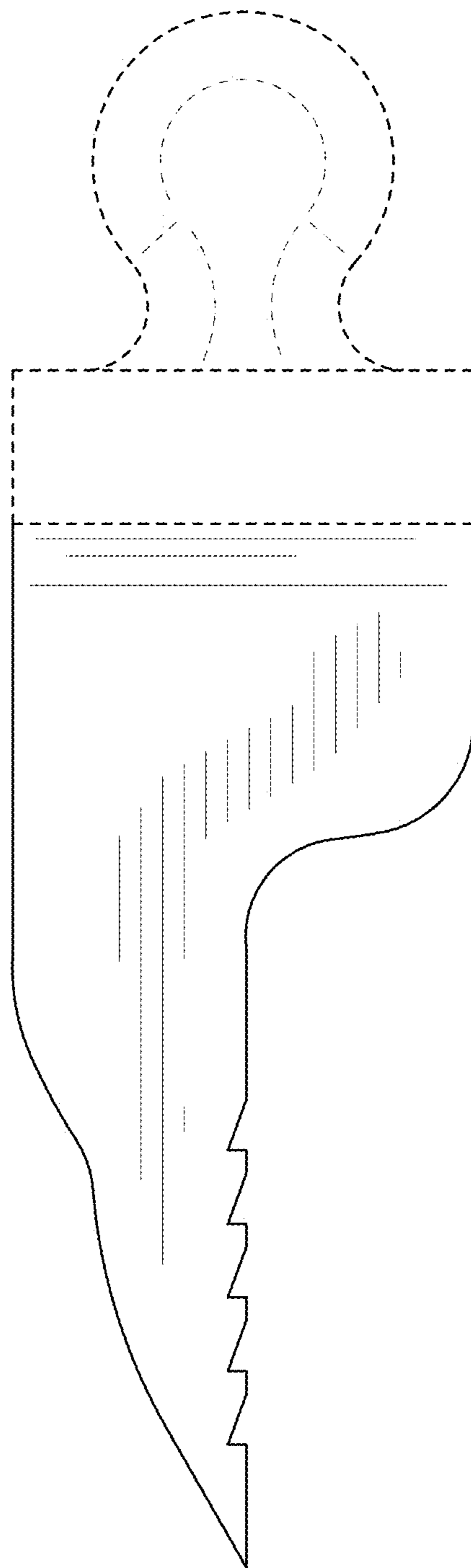

FIG. 4

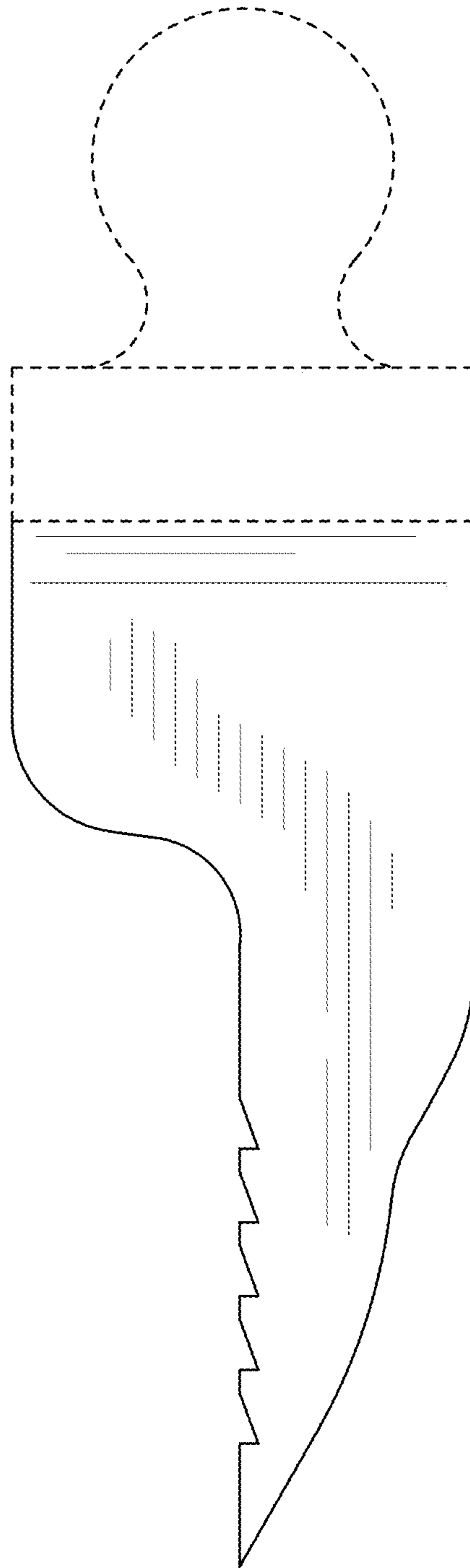

FIG. 5



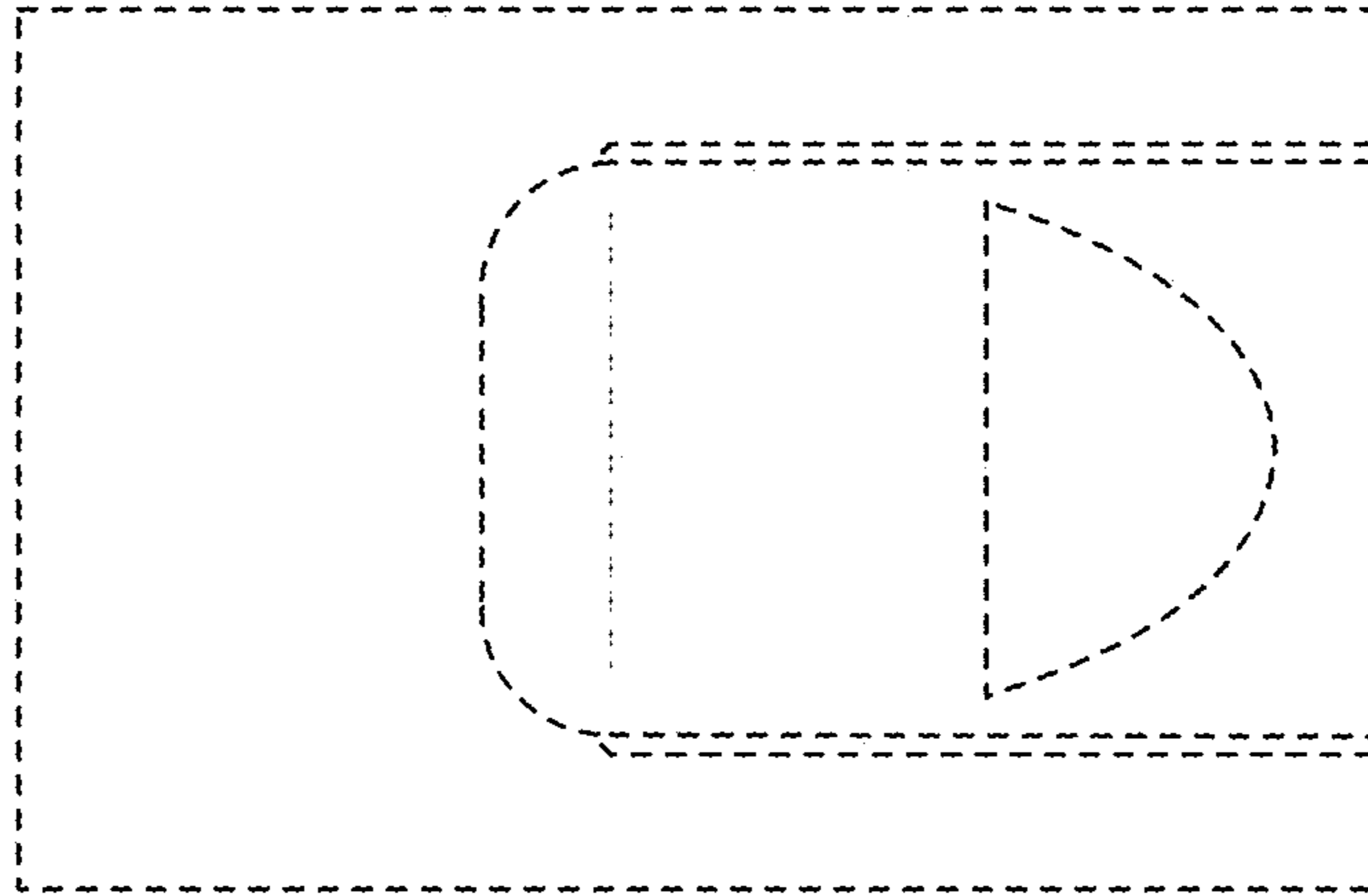

FIG. 6

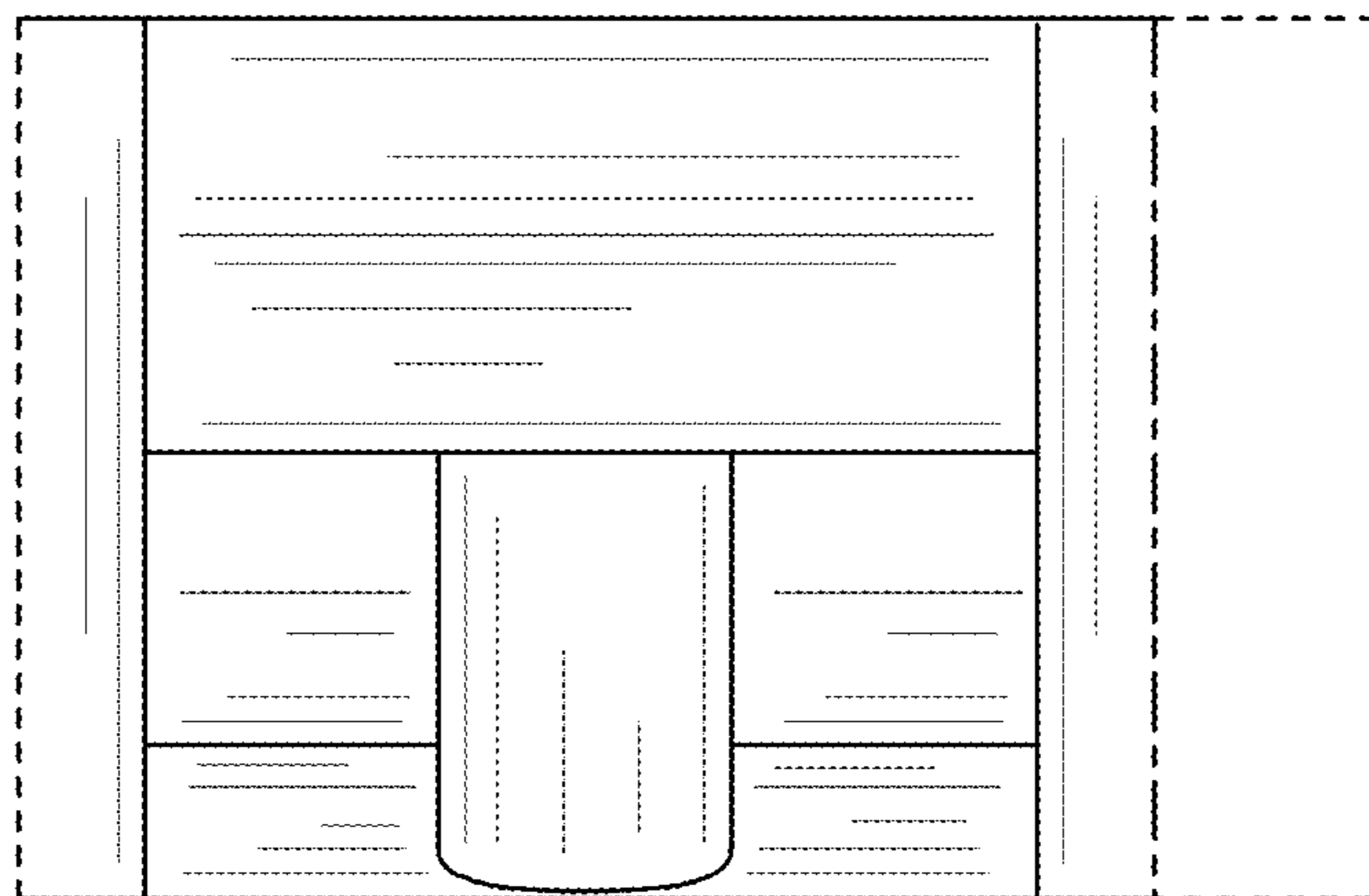

FIG. 7