



US00D933721S

(12) **United States Design Patent**
Henderson

(10) **Patent No.:** **US D933,721 S**
(45) **Date of Patent:** **** Oct. 19, 2021**

(54) **SPORTS-BALL-SHAPED REFRIGERATOR**

(71) Applicant: **4 Sizzle LLC**, Stateline, NV (US)

(72) Inventor: **Jason Henderson**, Tempe, AZ (US)

(73) Assignee: **4 SIZZLE LLC**, Stateline, NV (US)

(**) Term: **15 Years**

(21) Appl. No.: **29/718,468**

(22) Filed: **Dec. 24, 2019**

(51) **LOC (13) Cl.** **15-07**

(52) **U.S. Cl.**

USPC **D15/81; D15/88**

(58) **Field of Classification Search**

USPC D15/79, 80, 81, 82, 83, 84, 85, 86, 87,
D15/88, 89, 90, 91; D6/657, 659;

(Continued)

(56) **References Cited**

U.S. PATENT DOCUMENTS

D457,846 S * 5/2002 Burden D12/204
D462,732 S * 9/2002 Morrison D21/707

(Continued)

OTHER PUBLICATIONS

“Coca-Cola Soccer Ball 5 Can Cooler, 12V DC/110V AC Cooler, for home, dorm, office, travel, camping, car, boat, truck, beverages, snacks, skincare,” [online]. Koolatron. [Product first available on Mar. 17, 2014]. Retrieved from the Internet: <<https://www.amazon.com/Coca-Cola-CCSB-5-Soccer-Cooler/dp/B00J23C5PO>>.*

(Continued)

Primary Examiner — Mojtaba Tehrani

(74) *Attorney, Agent, or Firm* — Mitchell Law PLLC;
Matthew W. Mitchell

(57) **CLAIM**

The ornamental design for a sports-ball-shaped refrigerator, as shown and described.

DESCRIPTION

FIG. 1 is a front perspective view of the first embodiment of a sports-ball-shaped refrigerator, showing my new design; FIG. 2 is a front view thereof; FIG. 3 is a rear view thereof; FIG. 4 is a right-side view thereof; FIG. 5 is a left-side view thereof; FIG. 6 is a top plan view thereof; FIG. 7 is a bottom plan view thereof; FIG. 8 is a front perspective view of the second embodiment of a sports-ball-shaped refrigerator, showing my new design; FIG. 9 is a front view thereof; FIG. 10 is a rear view thereof; FIG. 11 is a right-side view thereof; FIG. 12 is a left-side view thereof; FIG. 13 is a top plan view thereof; FIG. 14 is a bottom plan view thereof; FIG. 15 is a front perspective view of the third embodiment of a sports-ball-shaped refrigerator, showing my new design; FIG. 16 is a front view thereof; FIG. 17 is a rear view thereof; FIG. 18 is a right-side view thereof; FIG. 19 is a left-side view thereof; FIG. 20 is a top plan view thereof; FIG. 21 is a bottom plan view thereof; FIG. 22 is a front perspective view of the fourth embodiment of a sports-ball-shaped refrigerator, showing my new design; FIG. 23 is a front view thereof; FIG. 24 is a rear view thereof; FIG. 25 is a right-side view thereof; FIG. 26 is a left-side view thereof; FIG. 27 is a top plan view thereof; and, FIG. 28 is a bottom plan view thereof.

The dot-dashed broken lines disclose unclaimed boundaries of the claimed design; the evenly broken lines disclose unclaimed subject matter.

1 Claim, 28 Drawing Sheets

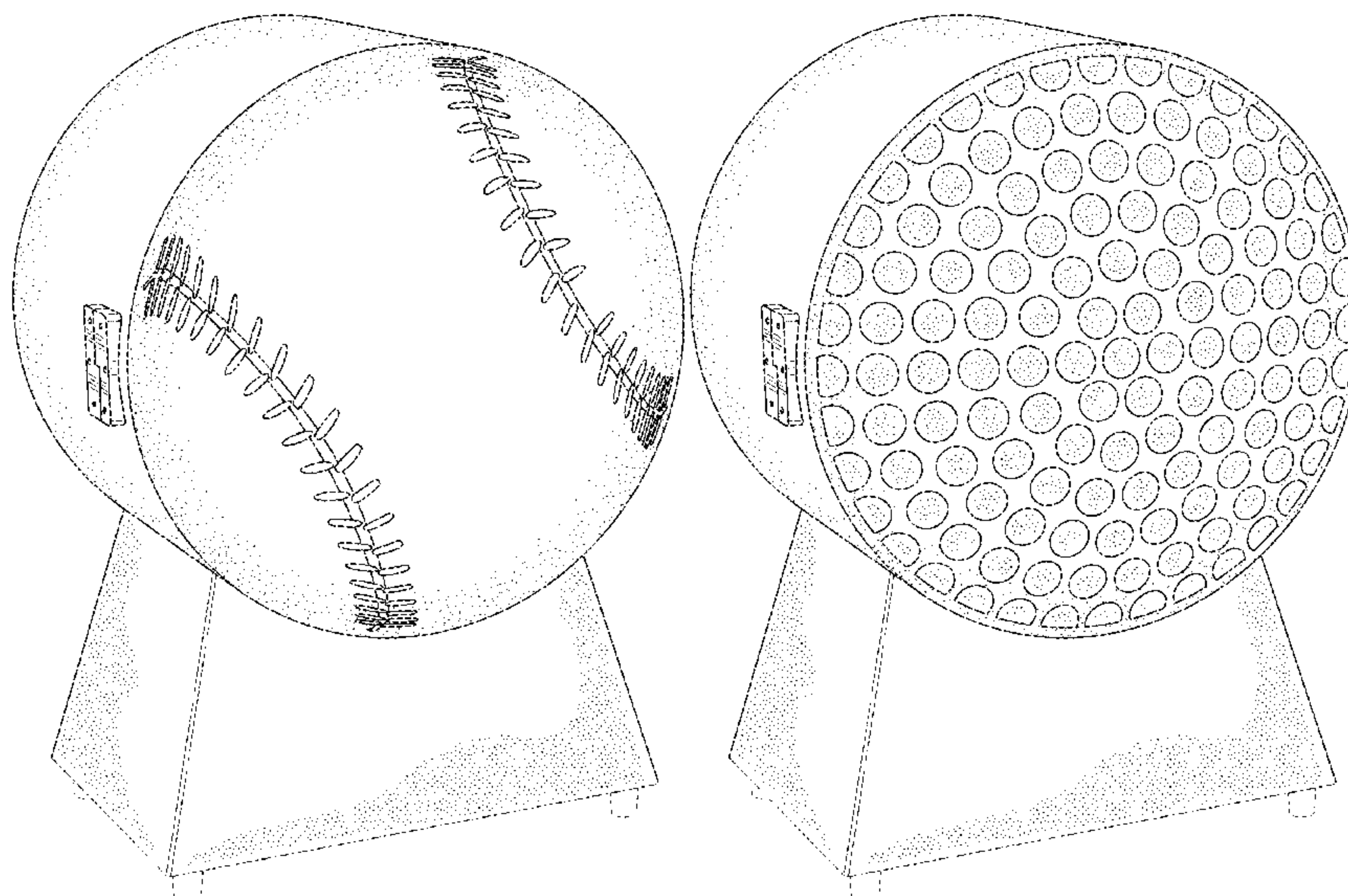

(58) **Field of Classification Search**

USPC D3/304, 307; D12/204, 207, 208, 500,
D12/501, 502; D21/701, 708, 712, 780,
D21/781
CPC F25C 2400/10; F25D 2400/10; F25D
2400/12; F25D 2400/14; F25D 2400/18;
G05B 2219/2654; G09F 23/0058; Y10S
292/71

See application file for complete search history.

(56) **References Cited**

U.S. PATENT DOCUMENTS

D473,179 S * 4/2003 Burden D12/204
D491,864 S * 6/2004 Hovren D12/204
D492,233 S * 6/2004 Burden D12/204
D681,073 S * 4/2013 Kilduff D15/82
D711,932 S * 8/2014 Kilduff D15/82
D727,445 S * 4/2015 Viramontez D21/713
D741,379 S * 10/2015 Esarey D15/82
D800,799 S * 10/2017 Feng D15/81
D807,929 S * 1/2018 Feng D15/81
D823,956 S * 7/2018 Shin D21/708
D844,720 S * 4/2019 Adams D21/713
D848,494 S * 5/2019 Hua D15/90
D864,322 S * 10/2019 Finley D21/708
D868,539 S * 12/2019 Paulin D7/515
D896,856 S * 9/2020 Zhou D15/81
D919,678 S * 5/2021 Yang D15/81

OTHER PUBLICATIONS

<https://www.koolatron.com/CA/en/coca-cola-soccer-ball-cooler>.

* cited by examiner

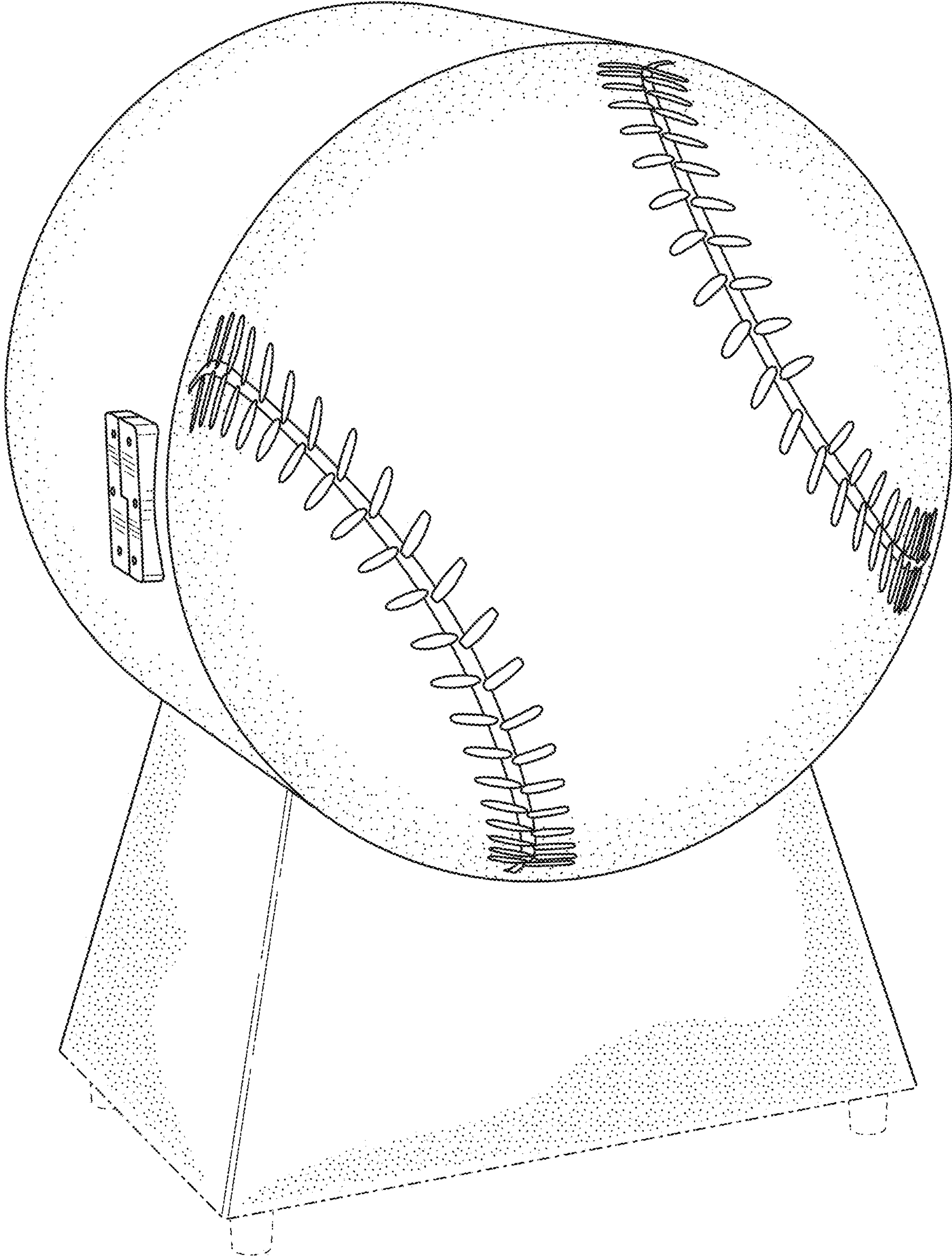

FIG. 1

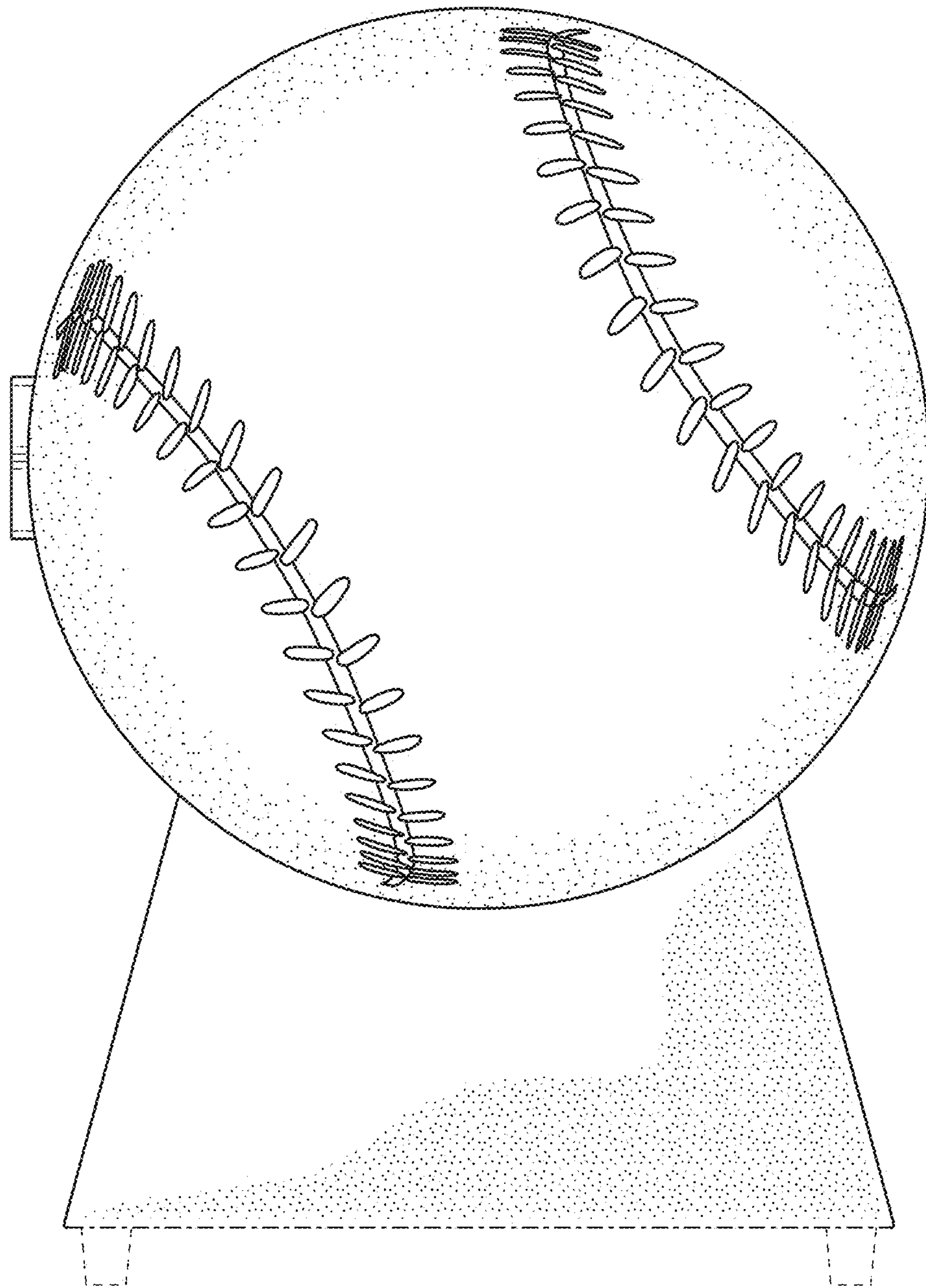

FIG. 2

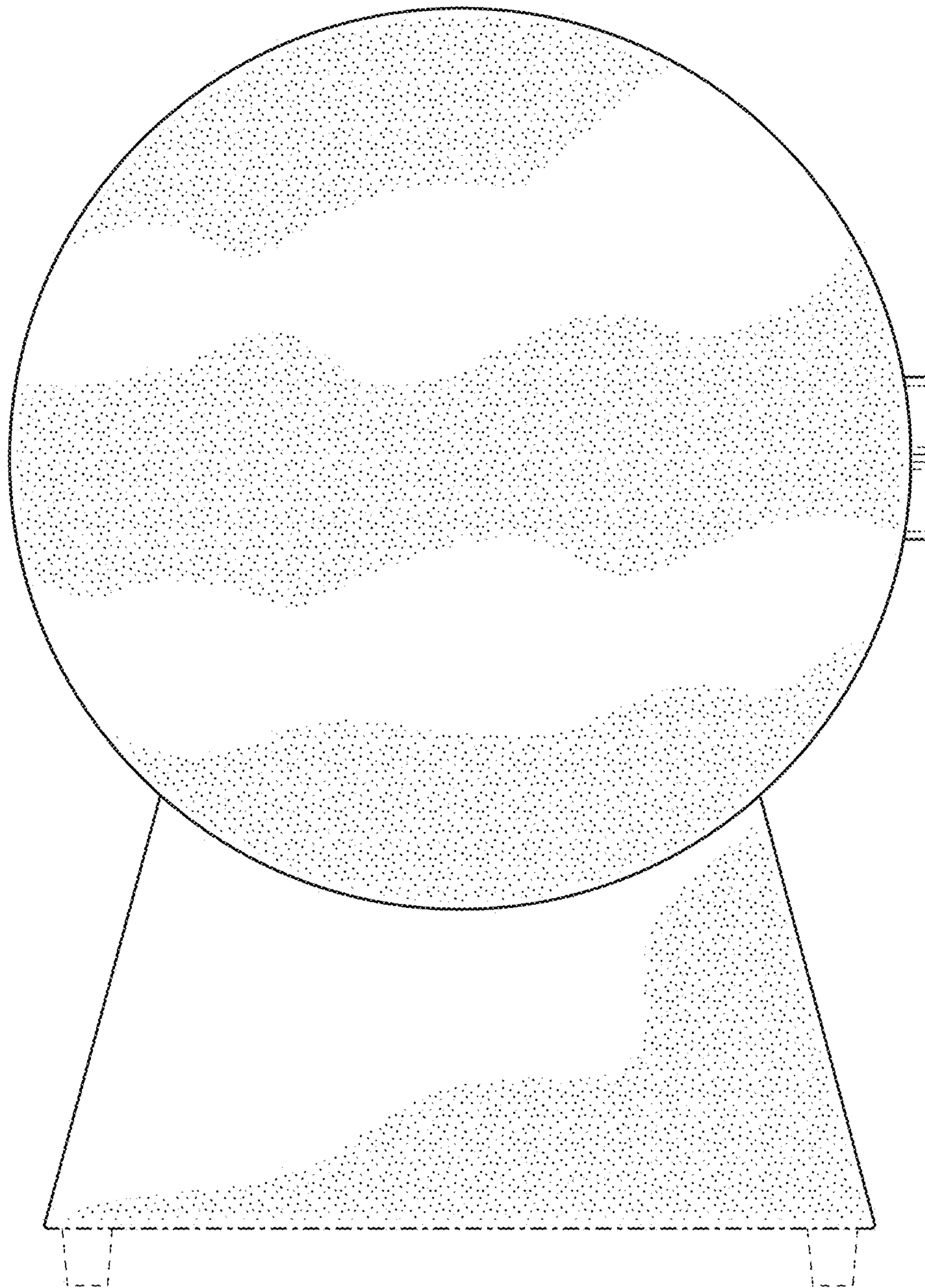

FIG. 3

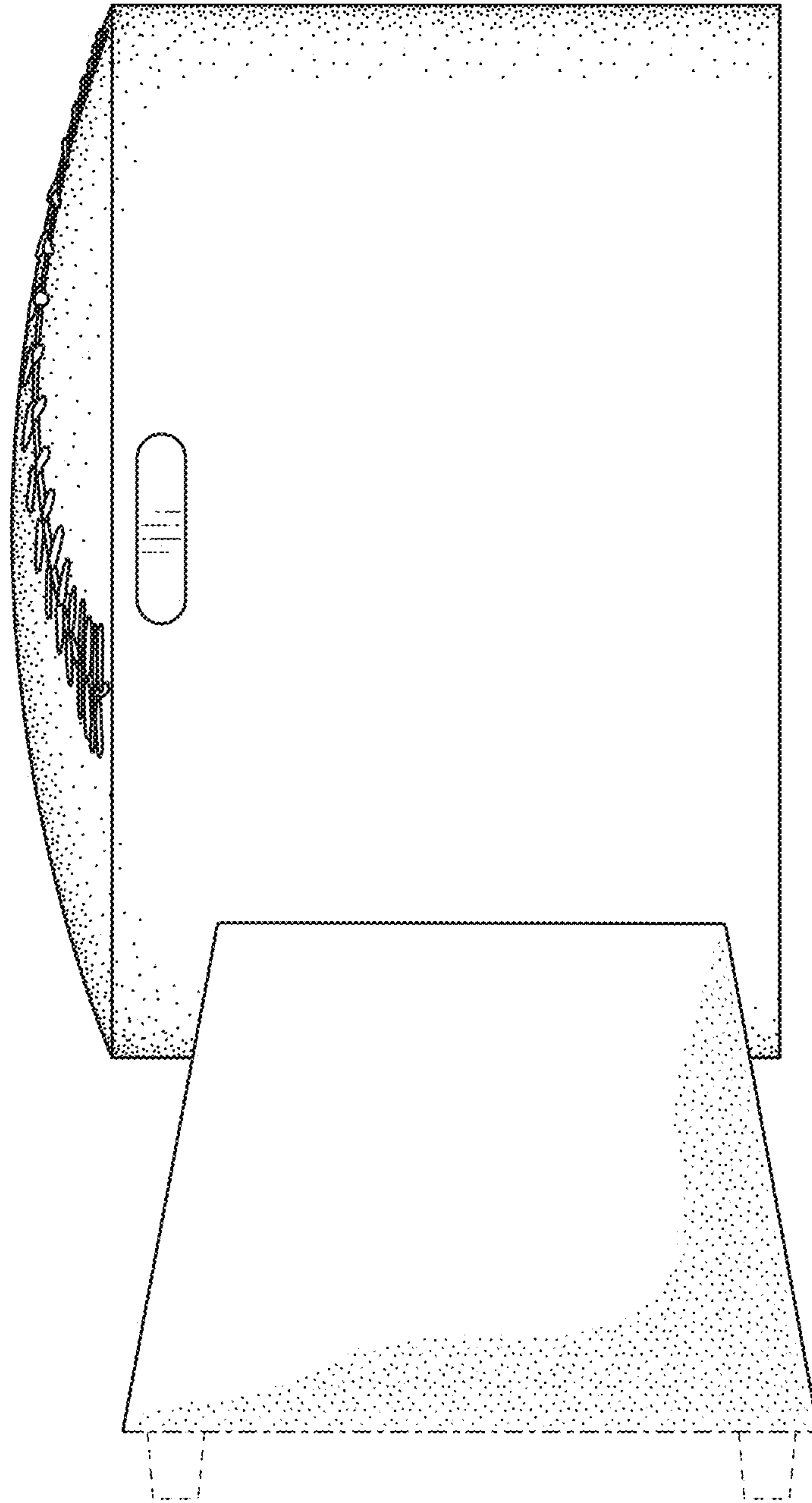

FIG. 4

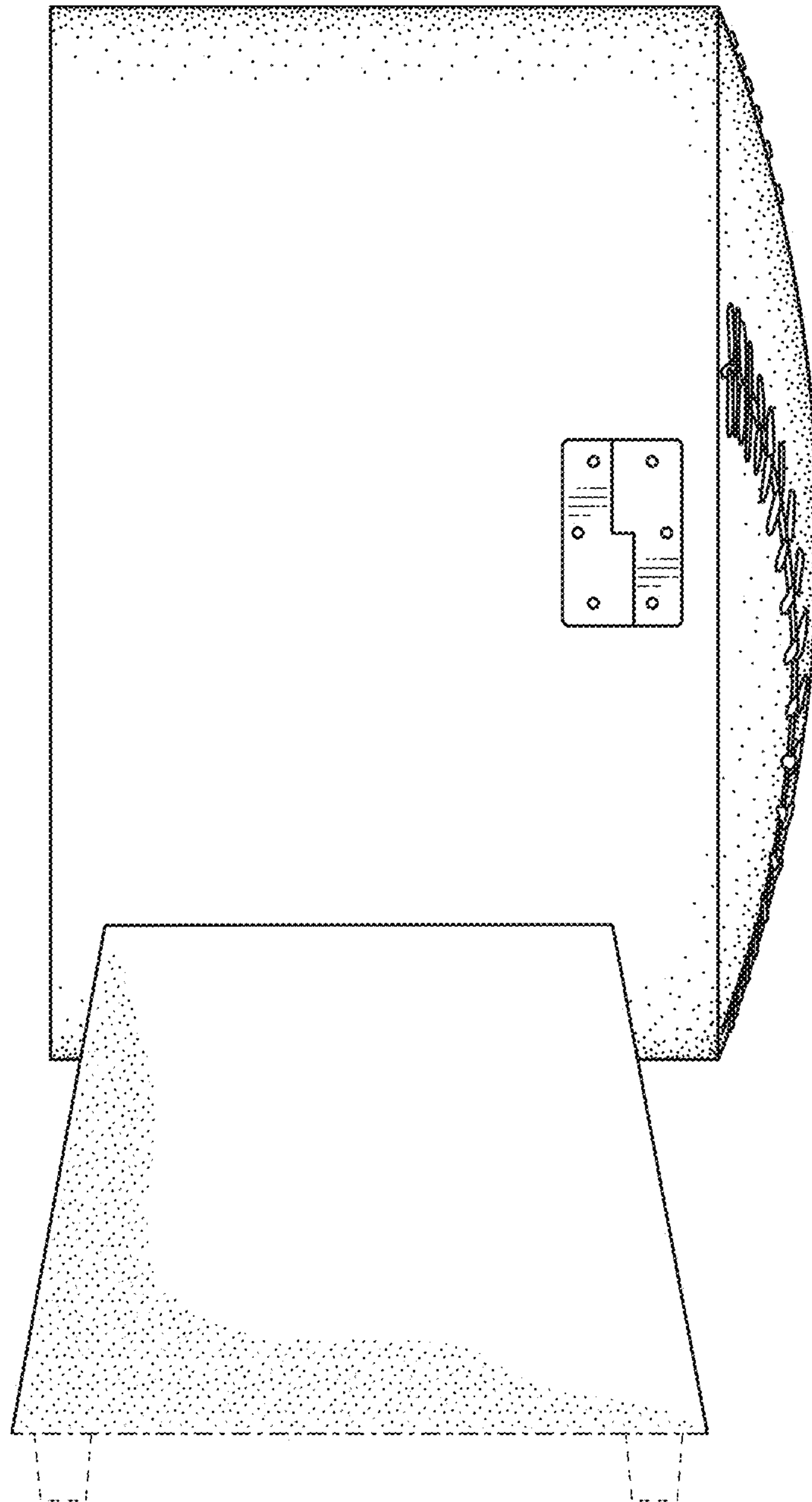

FIG. 5

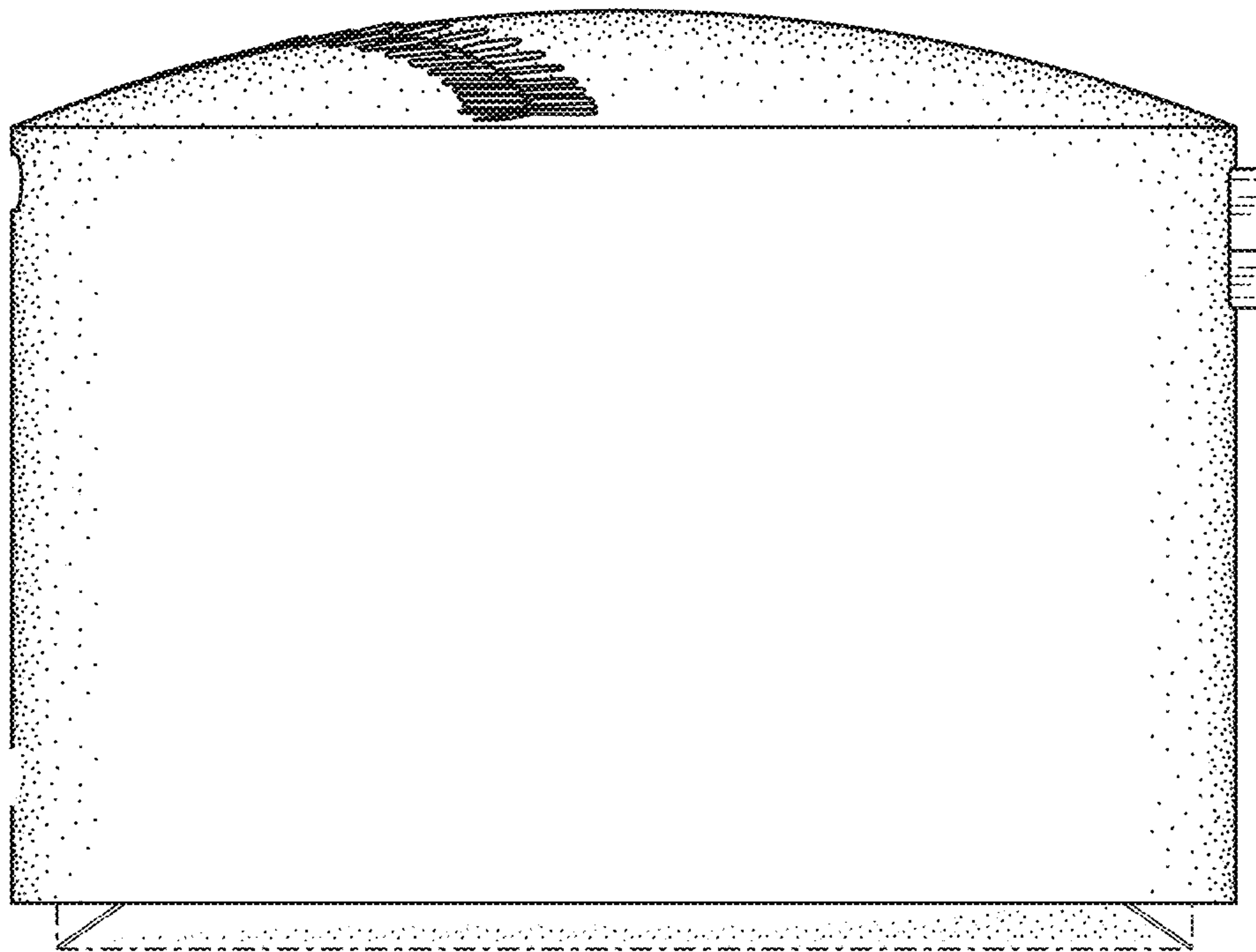

FIG. 6

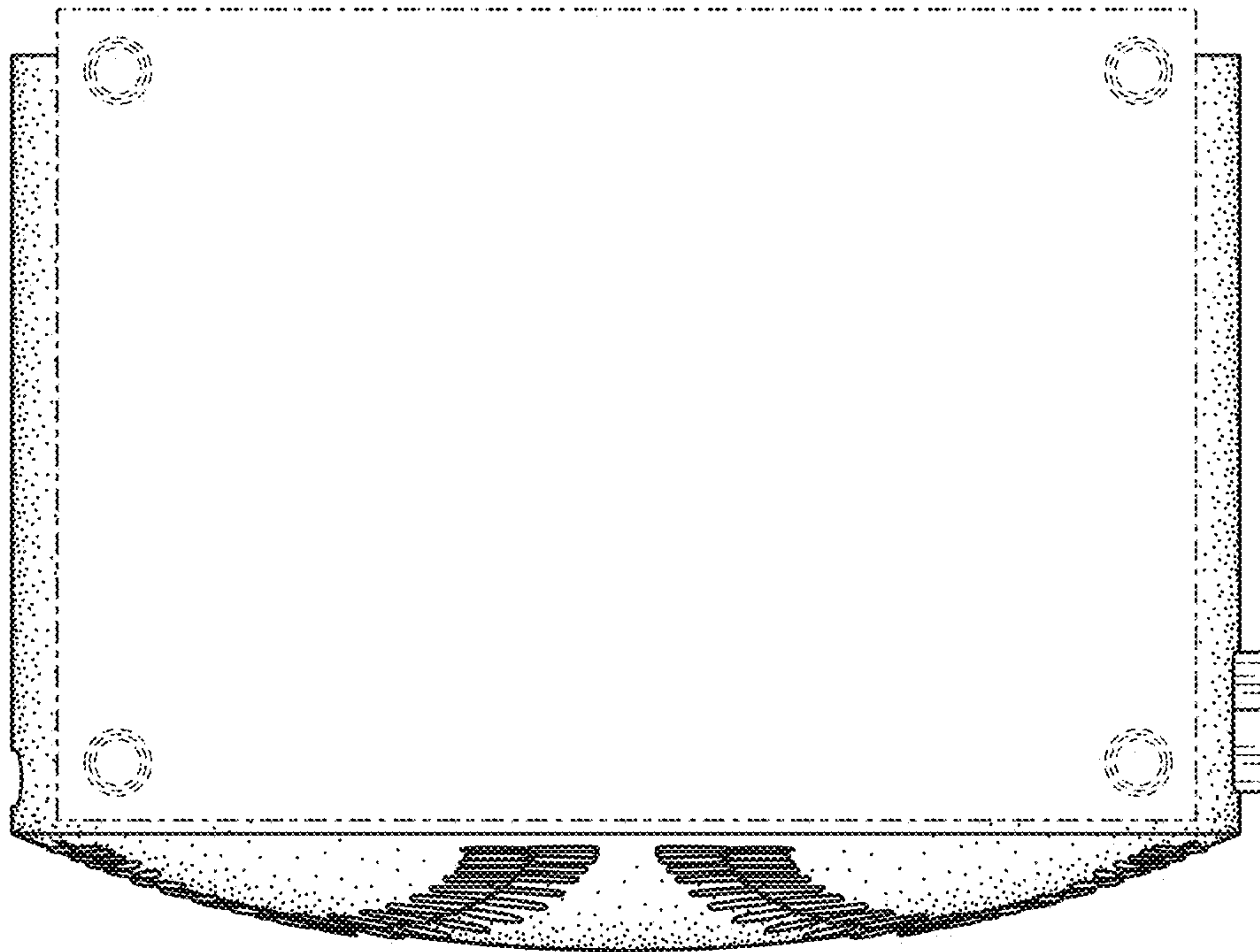

FIG. 7

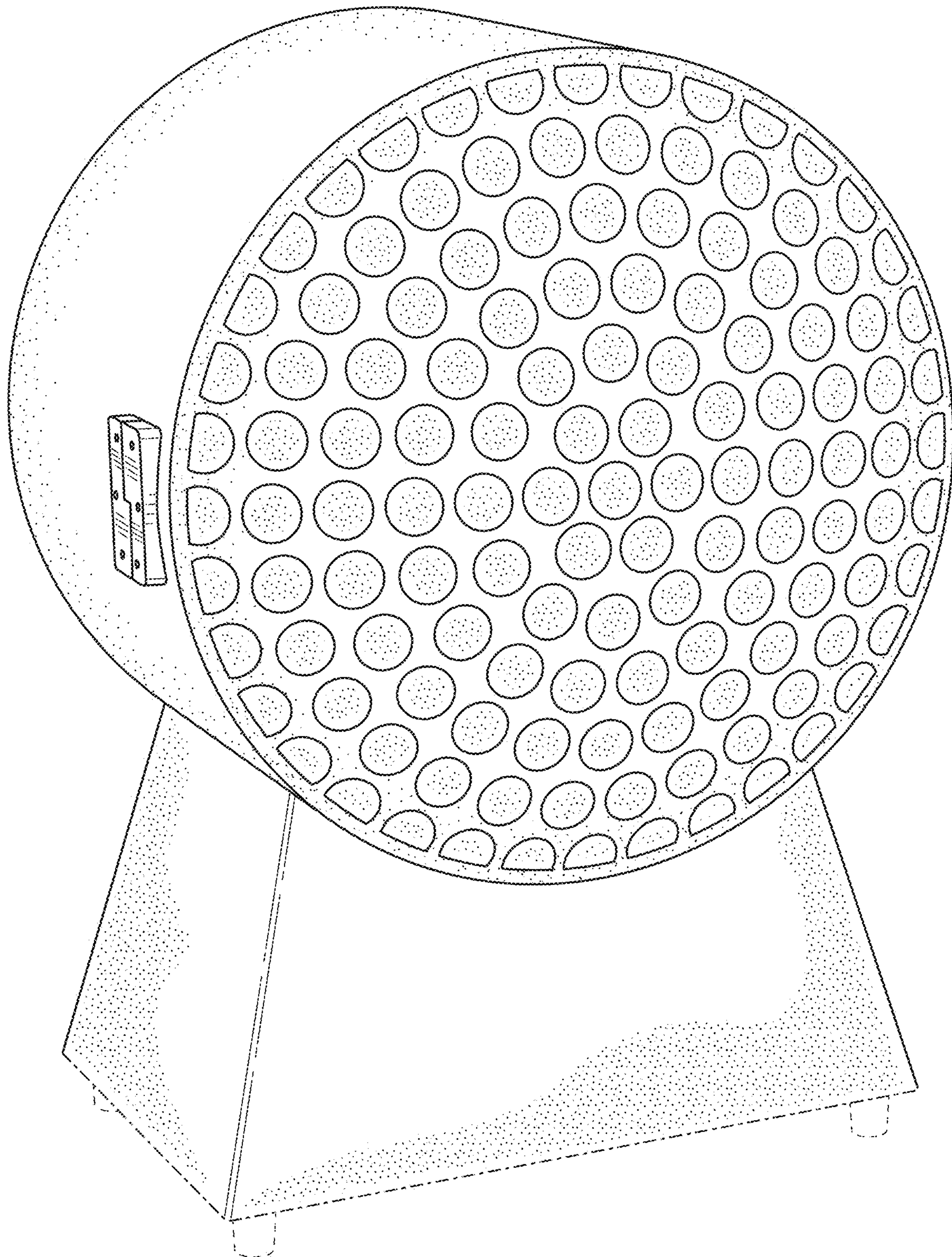

FIG. 8

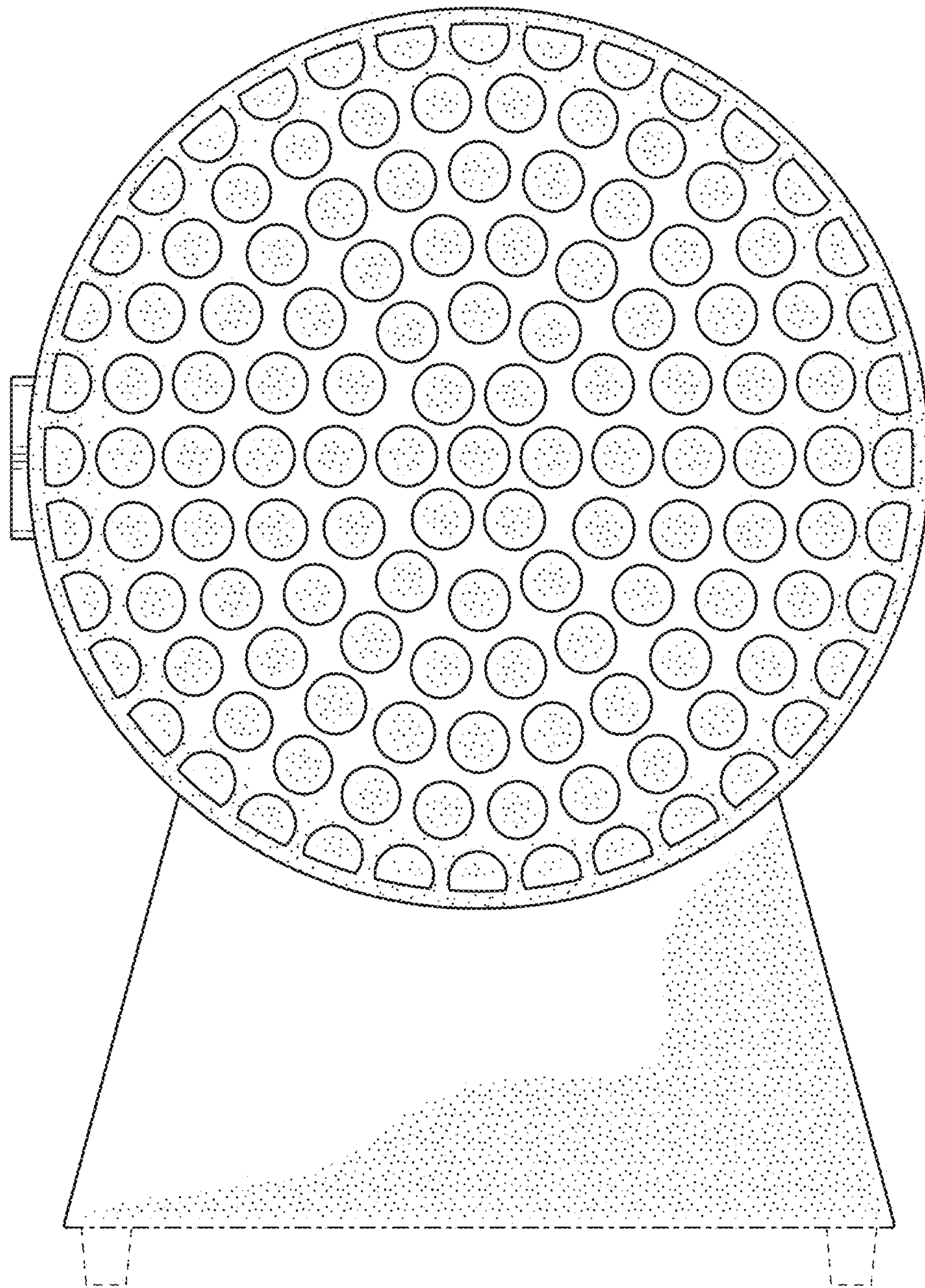

FIG. 9

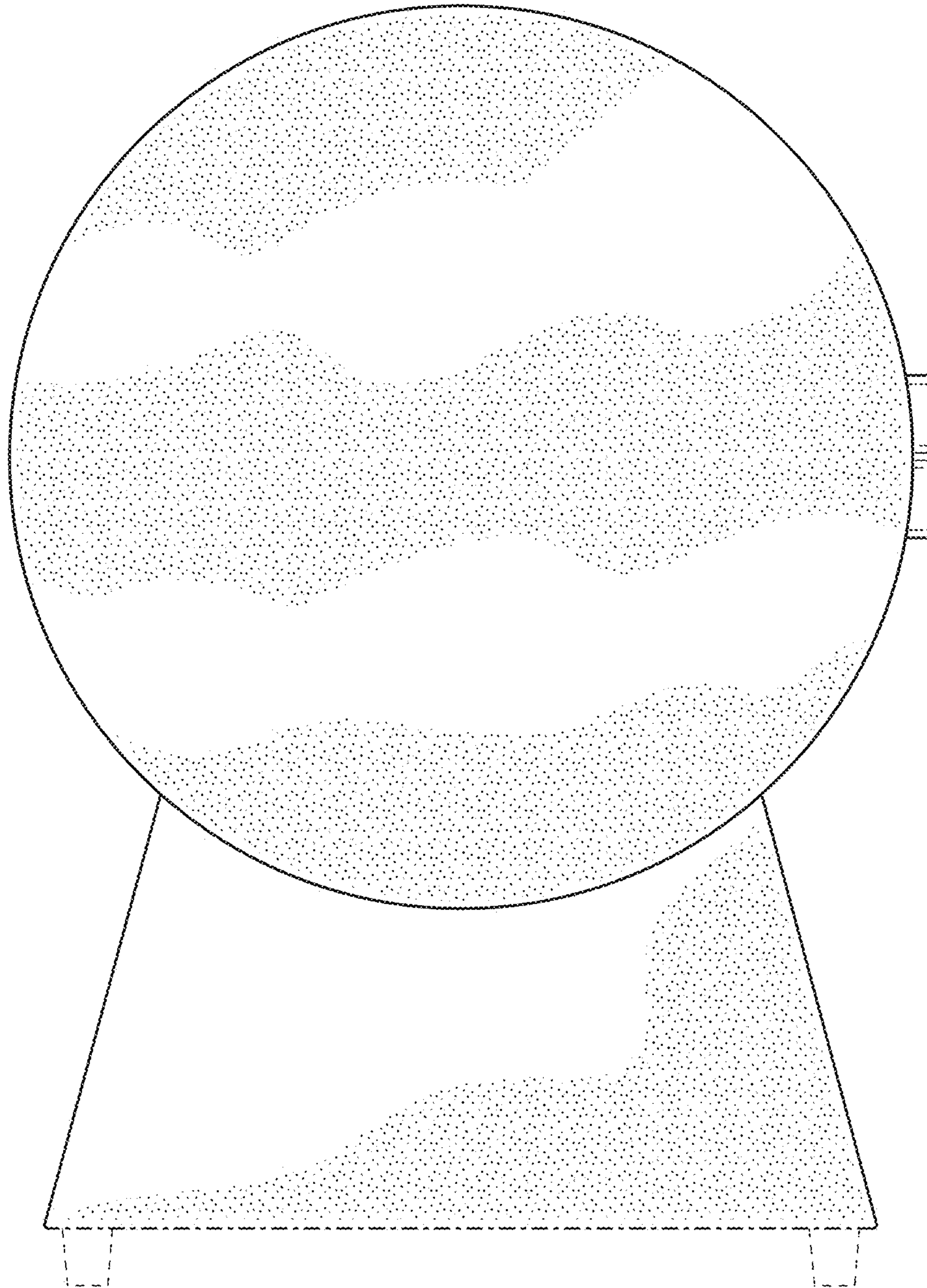

FIG. 10

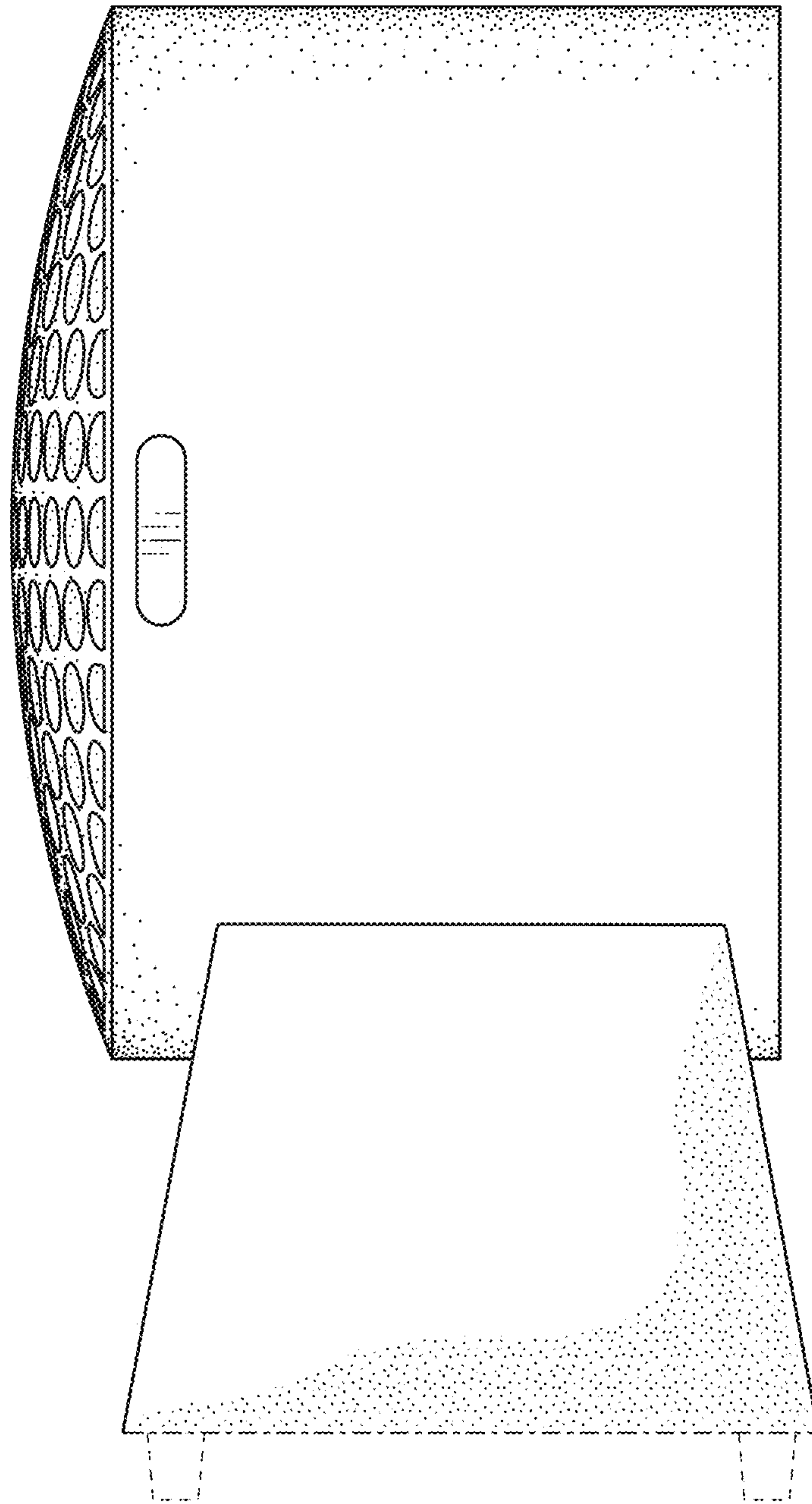

FIG. 11

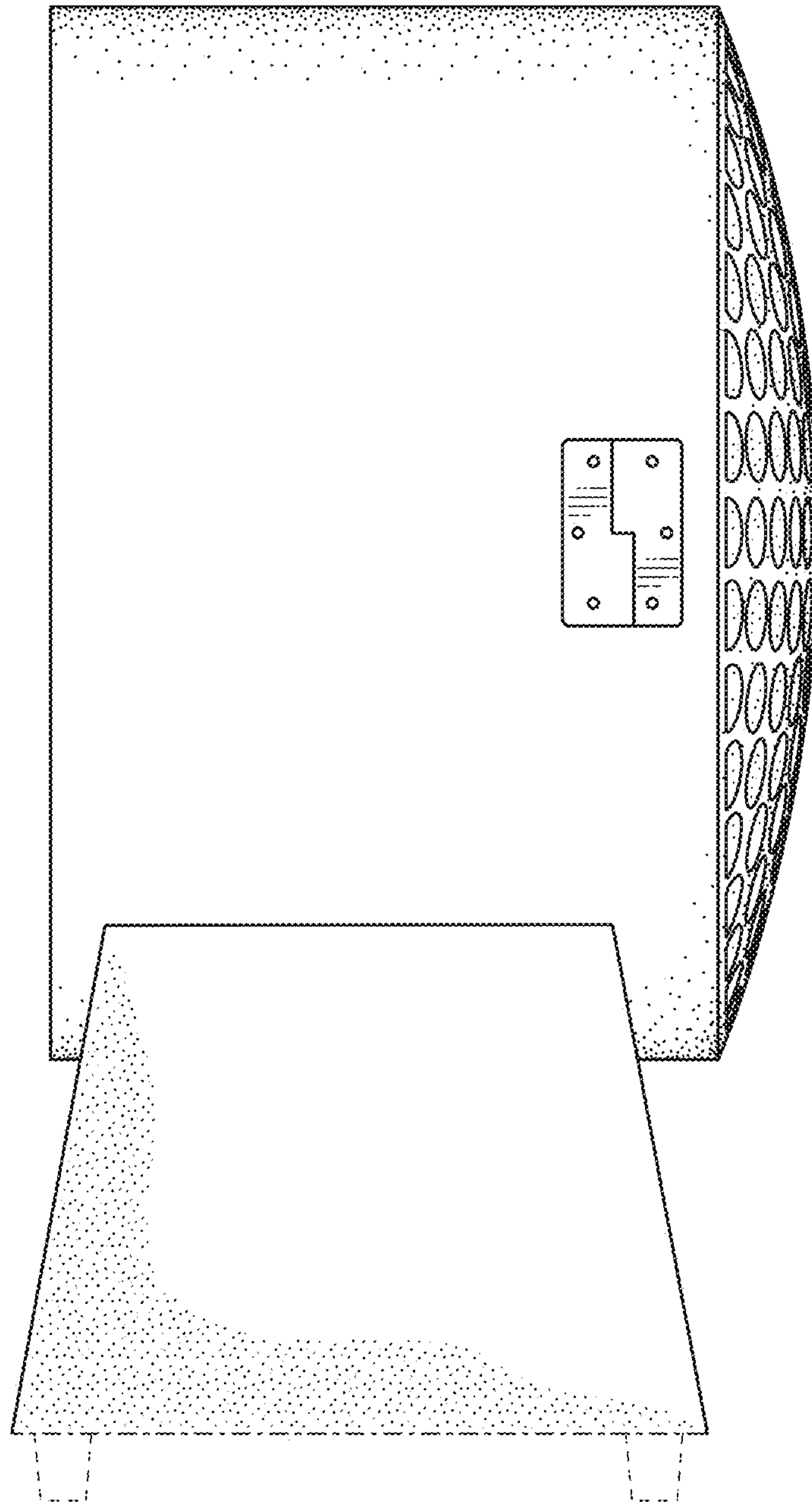

FIG. 12

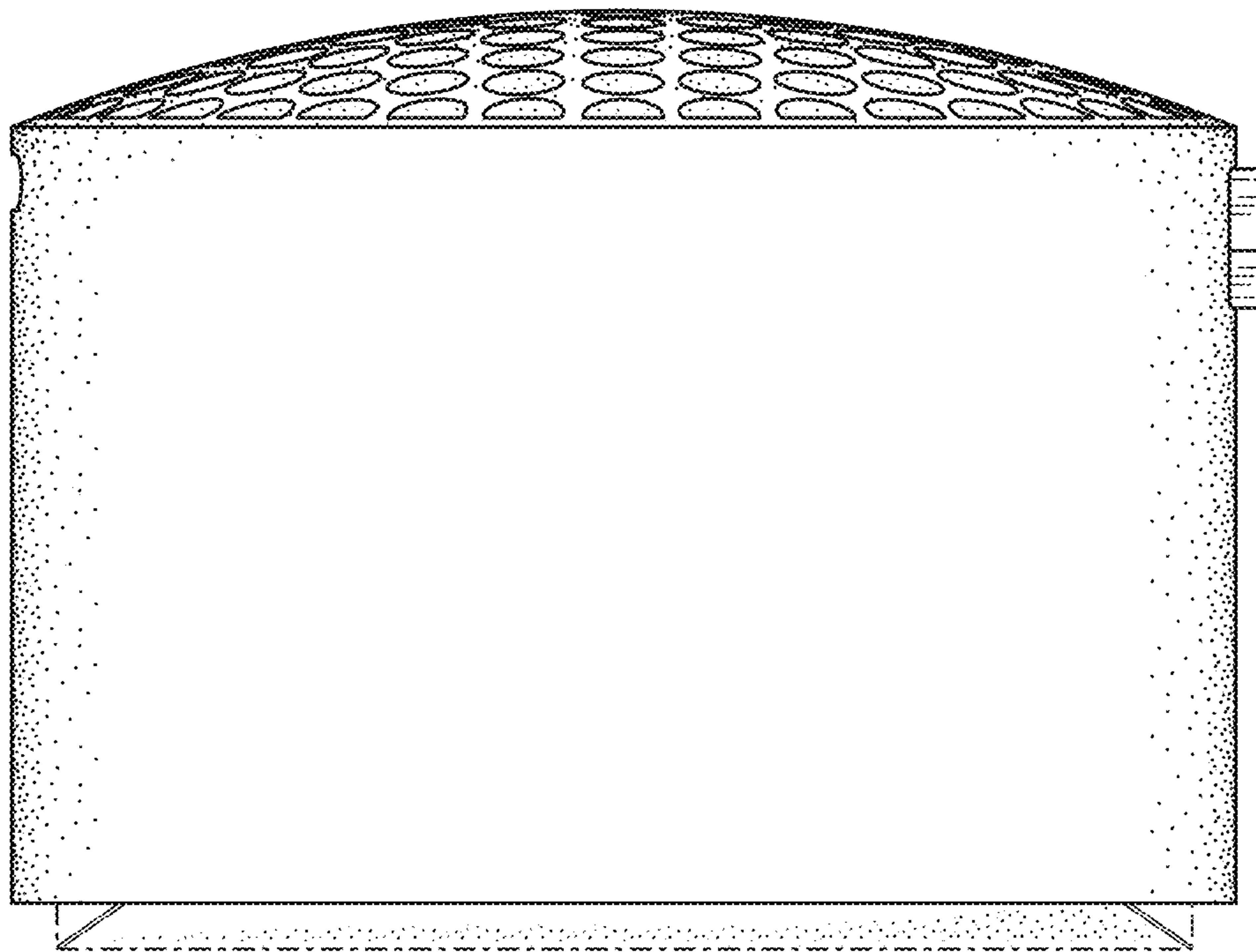

FIG. 13

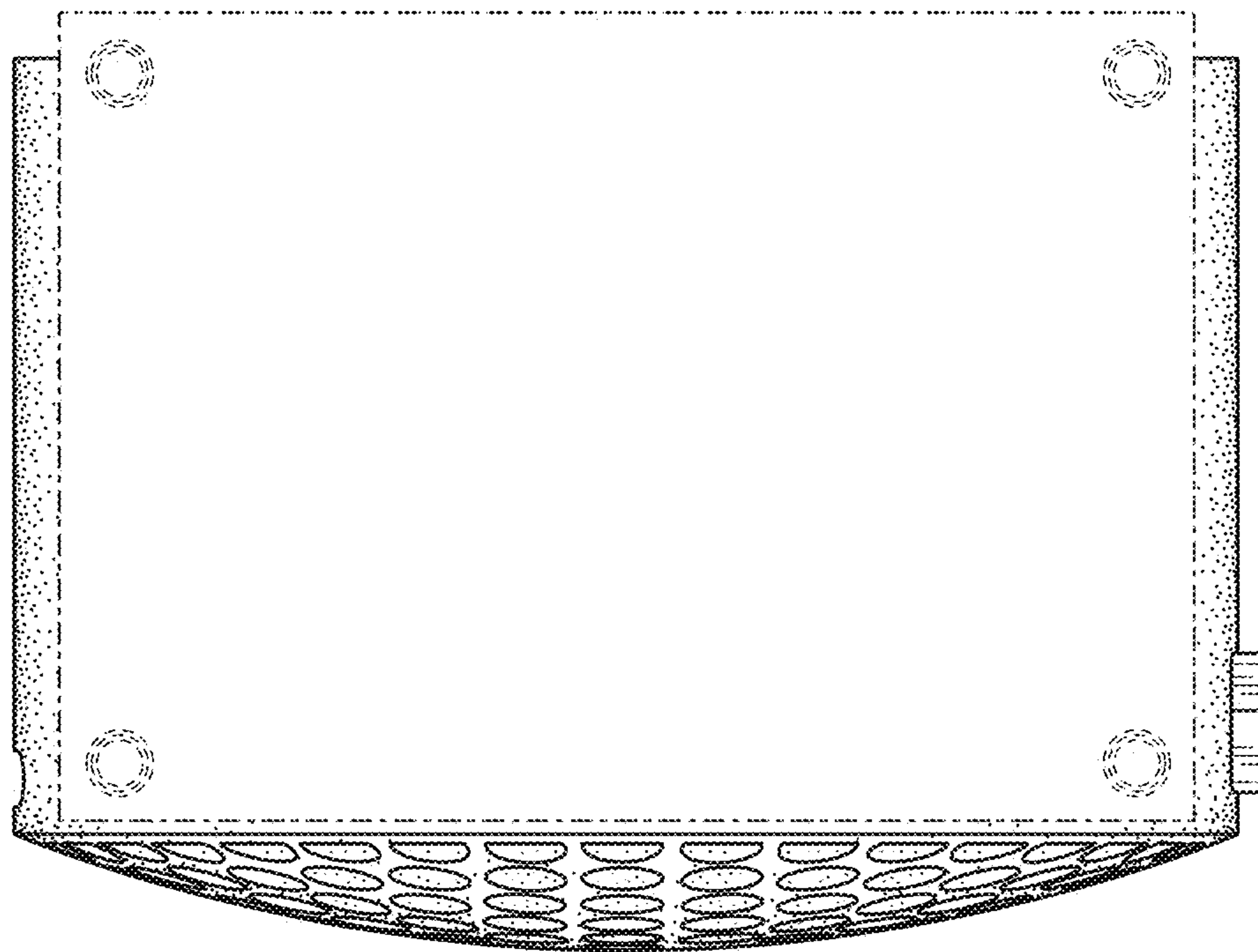

FIG. 14

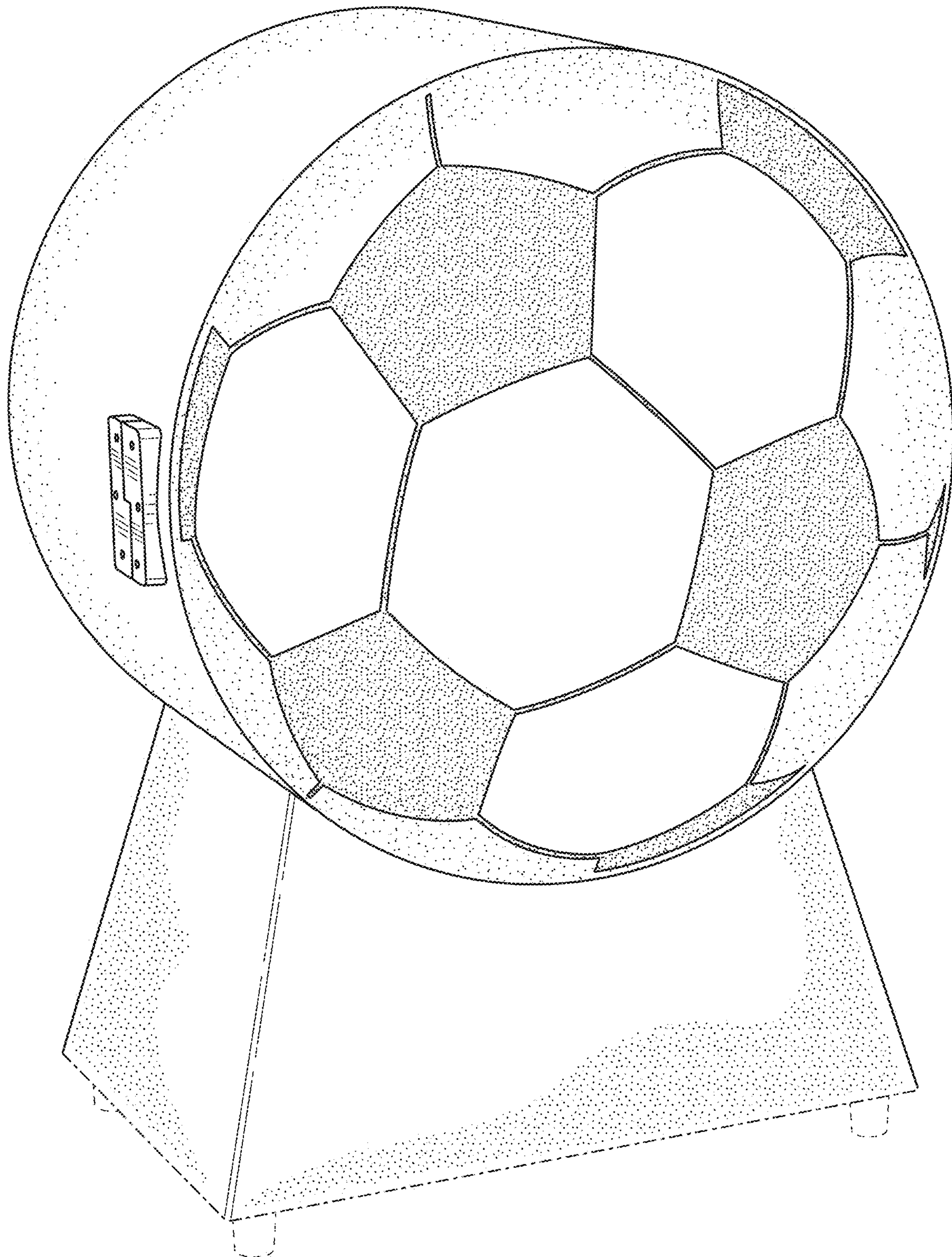

FIG. 15

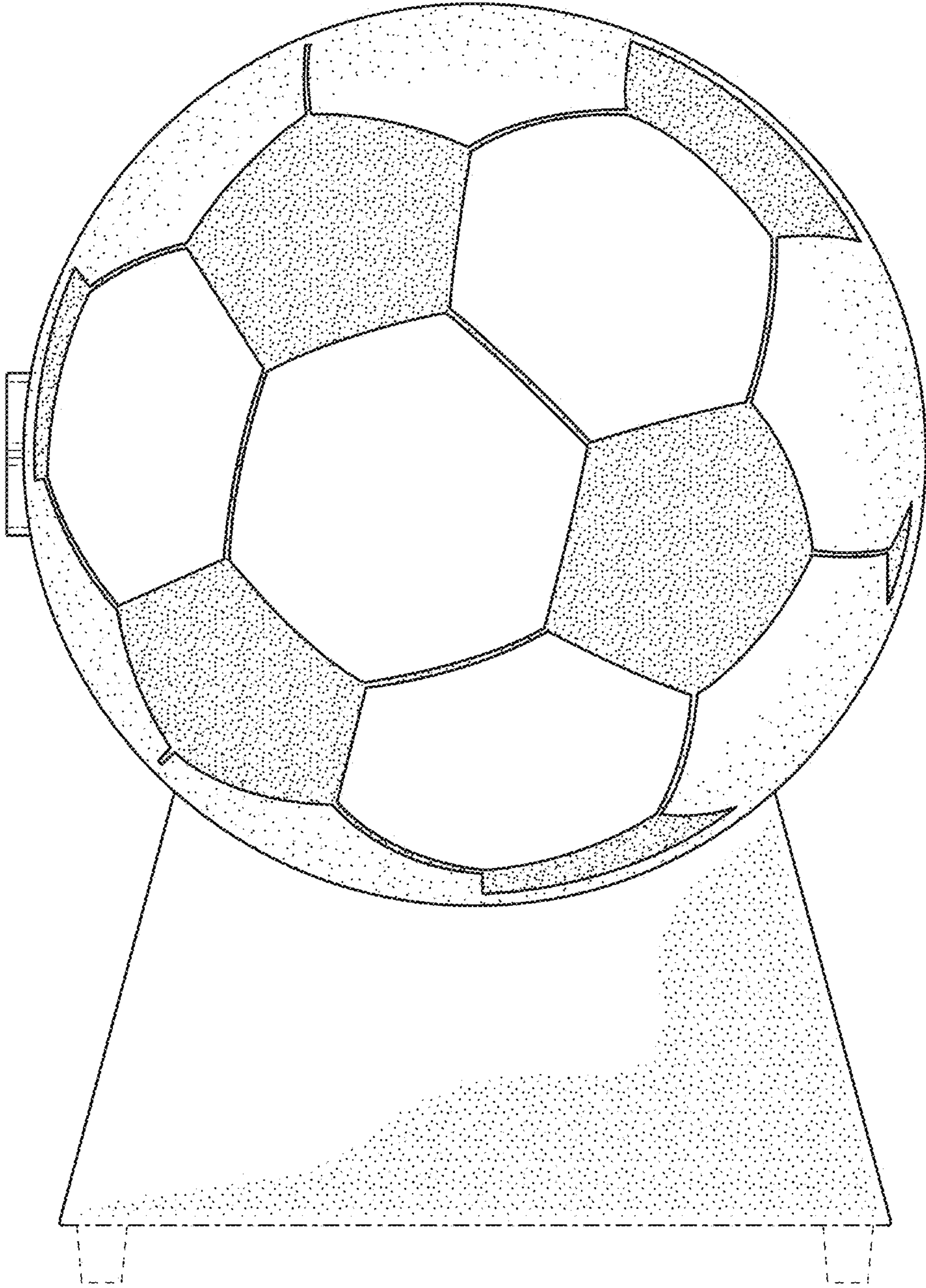

FIG. 16

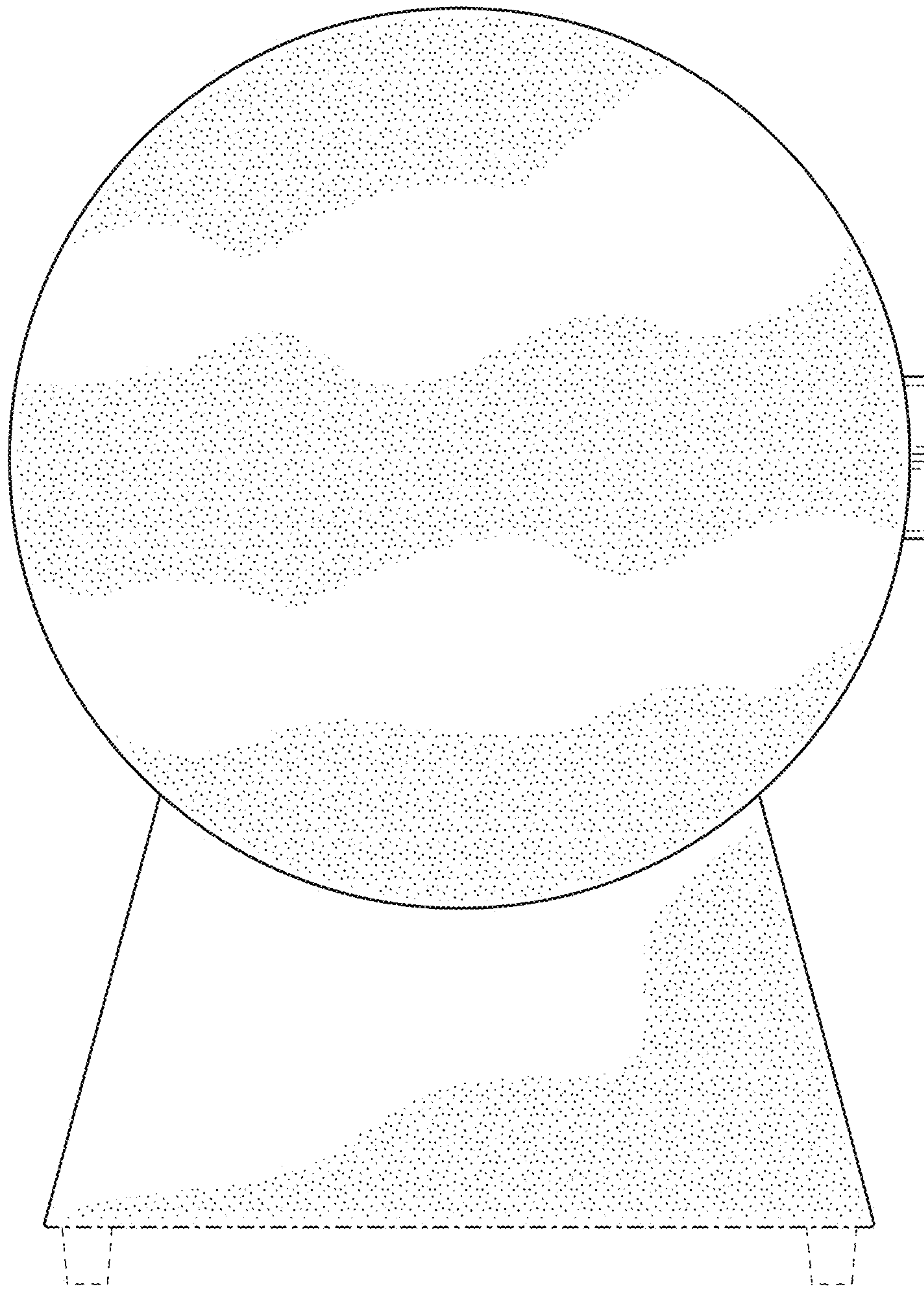

FIG. 17

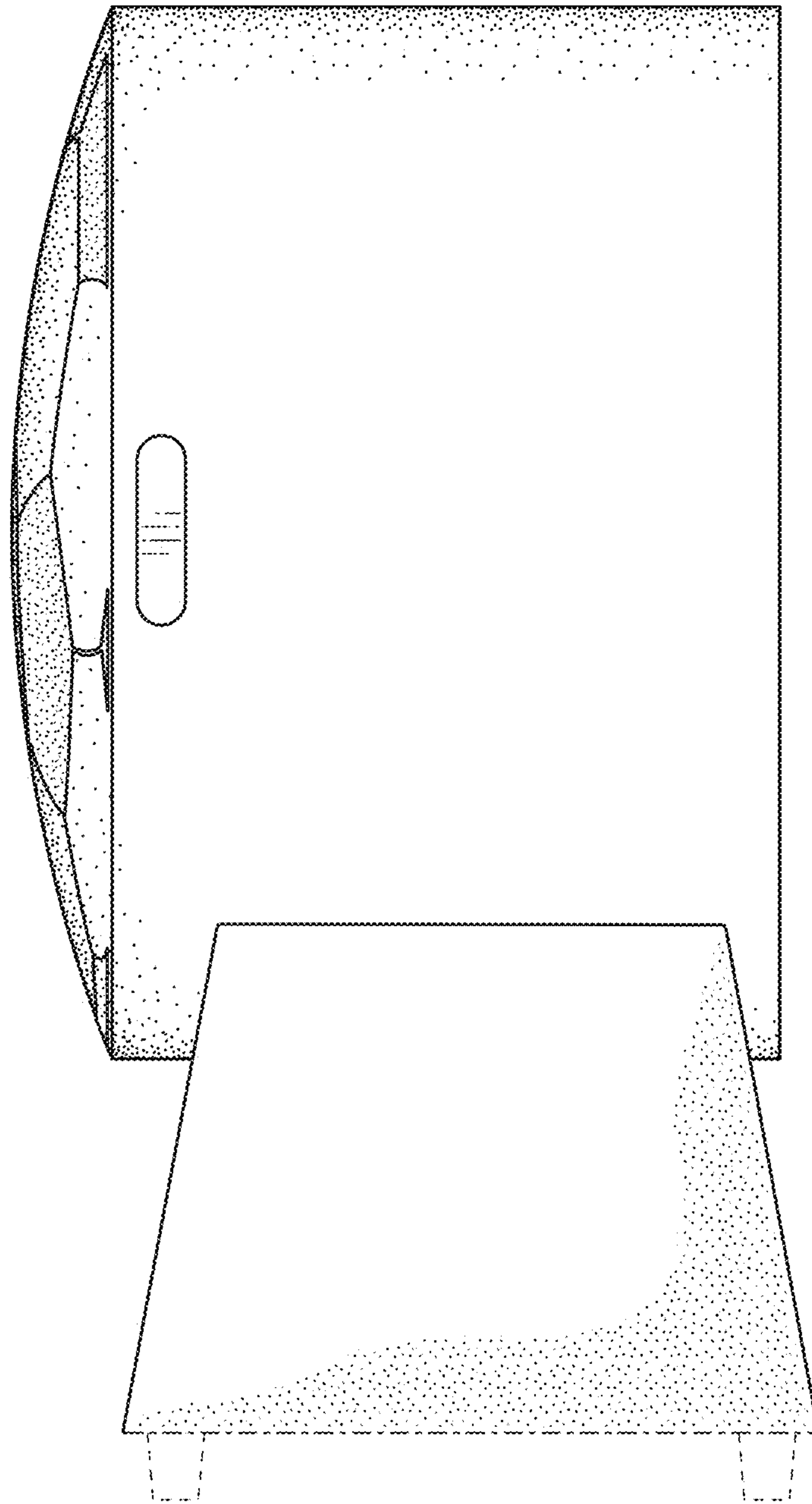

FIG. 18

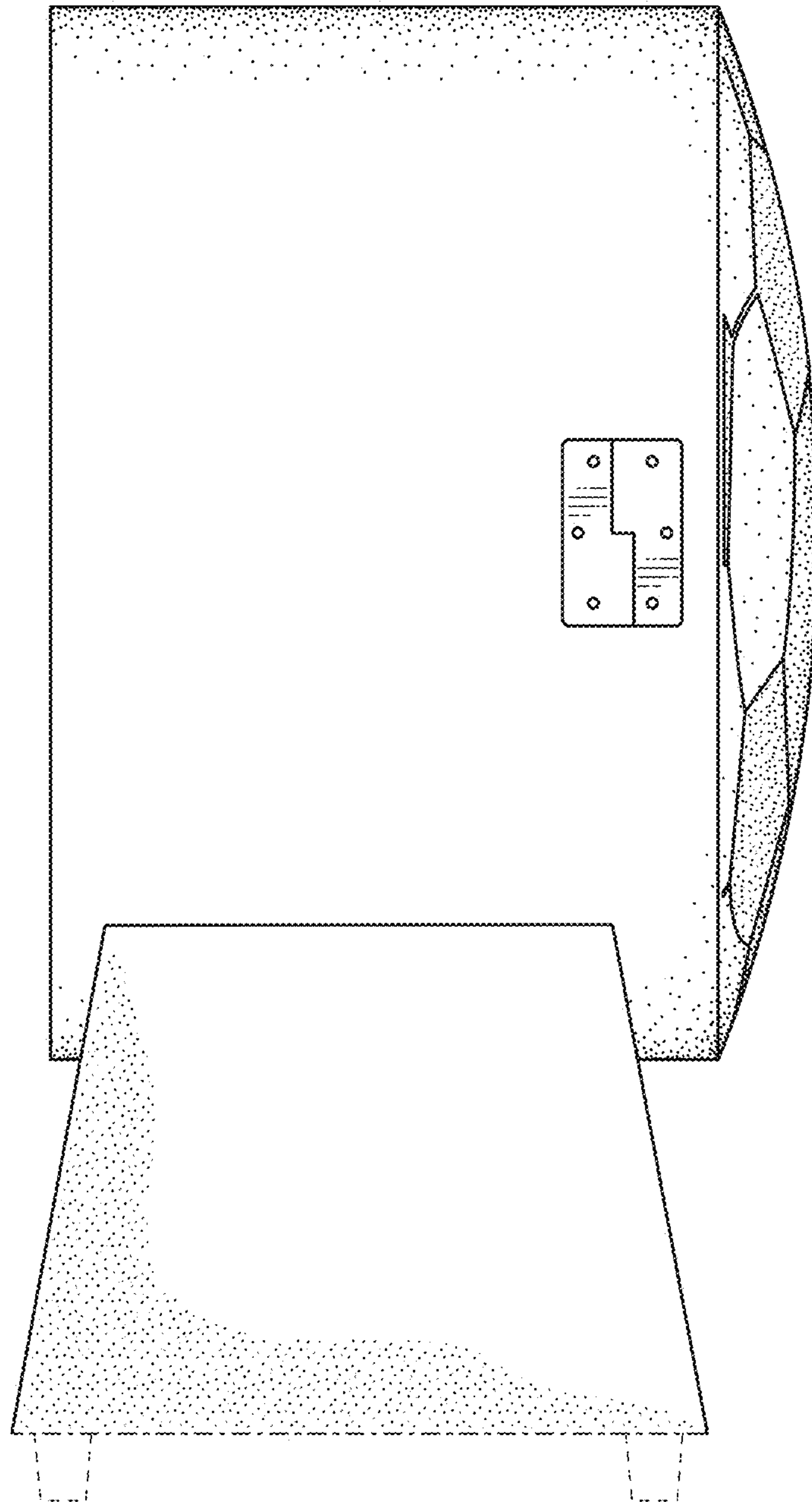

FIG. 19

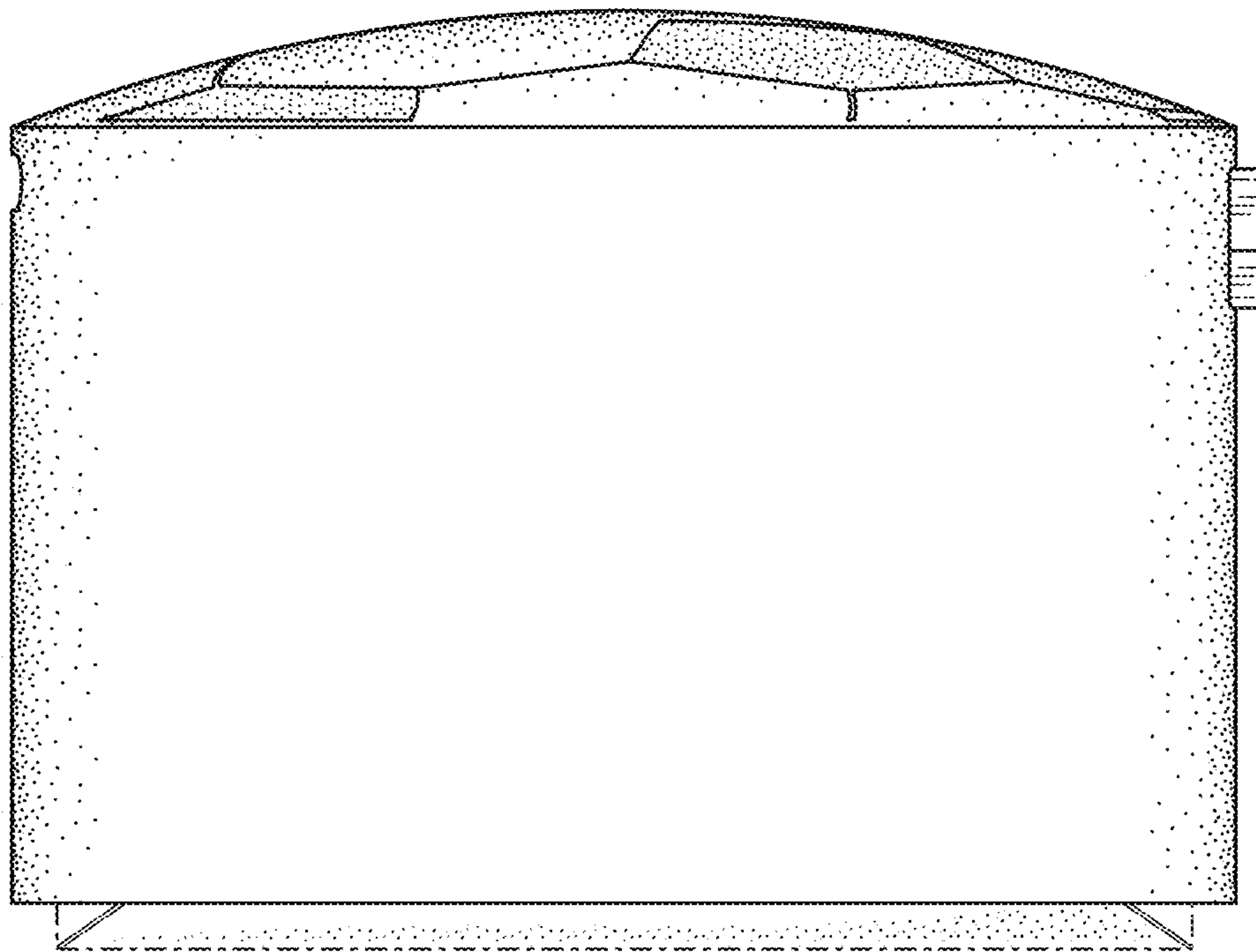

FIG. 20

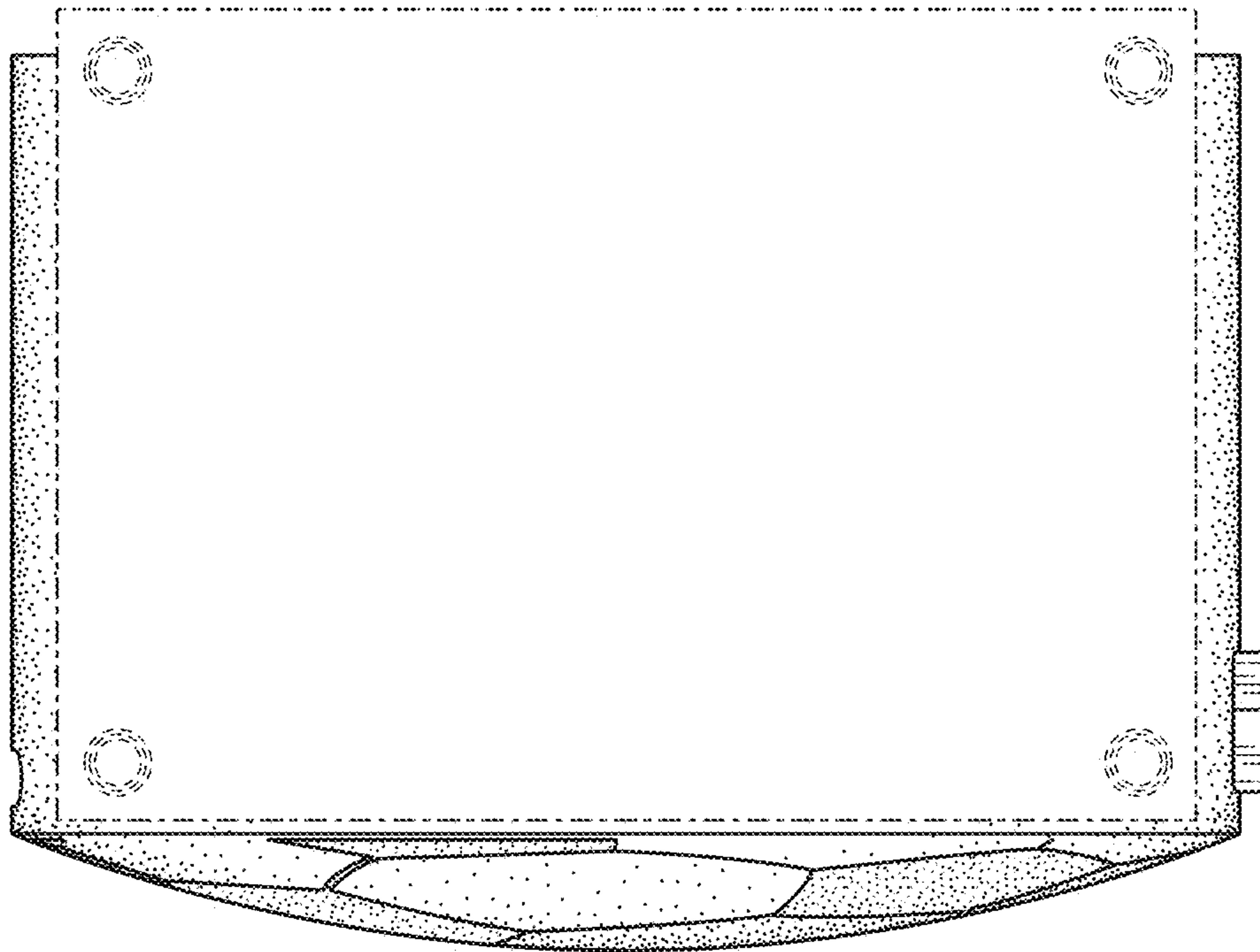

FIG. 21

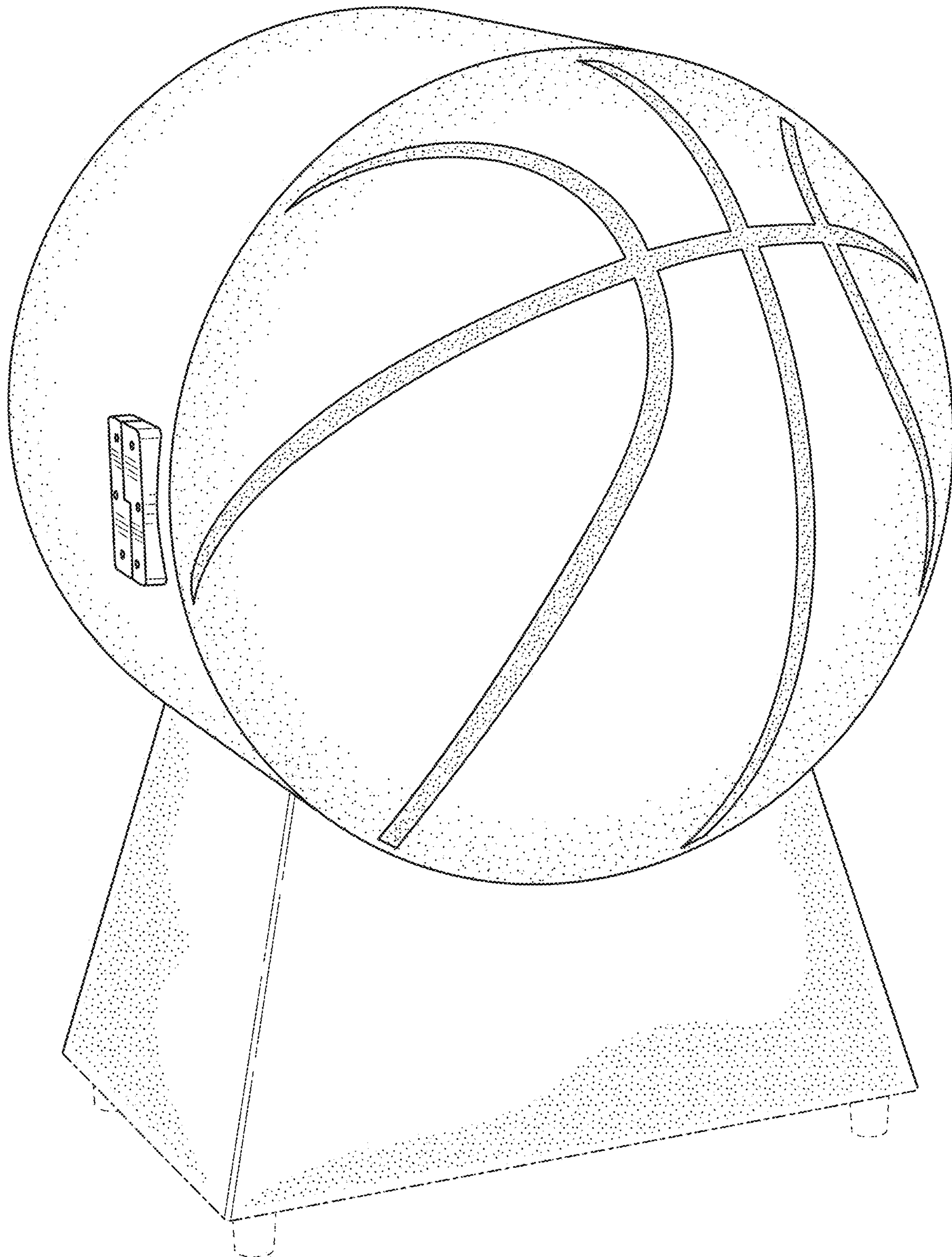

FIG. 22

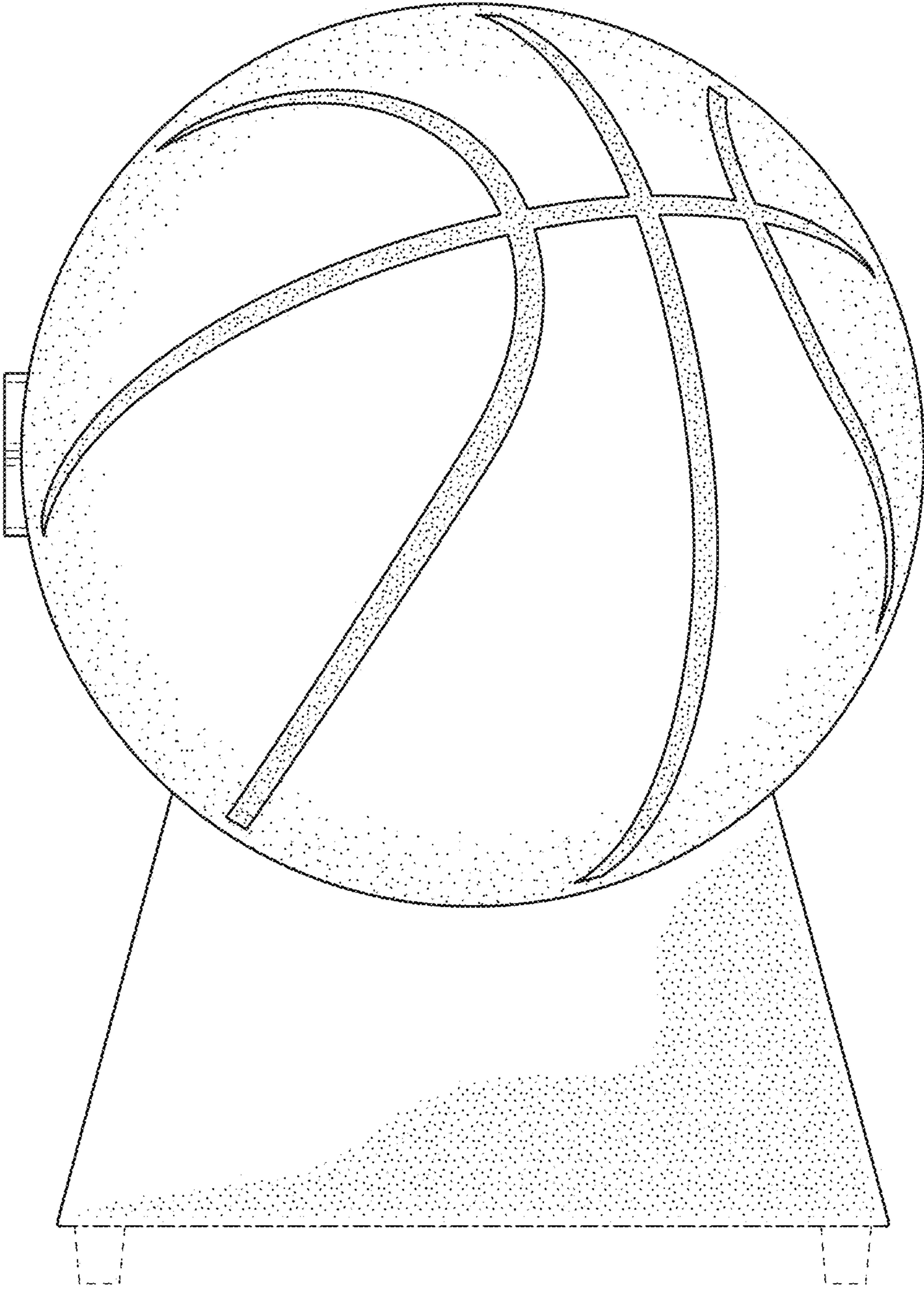

FIG. 23

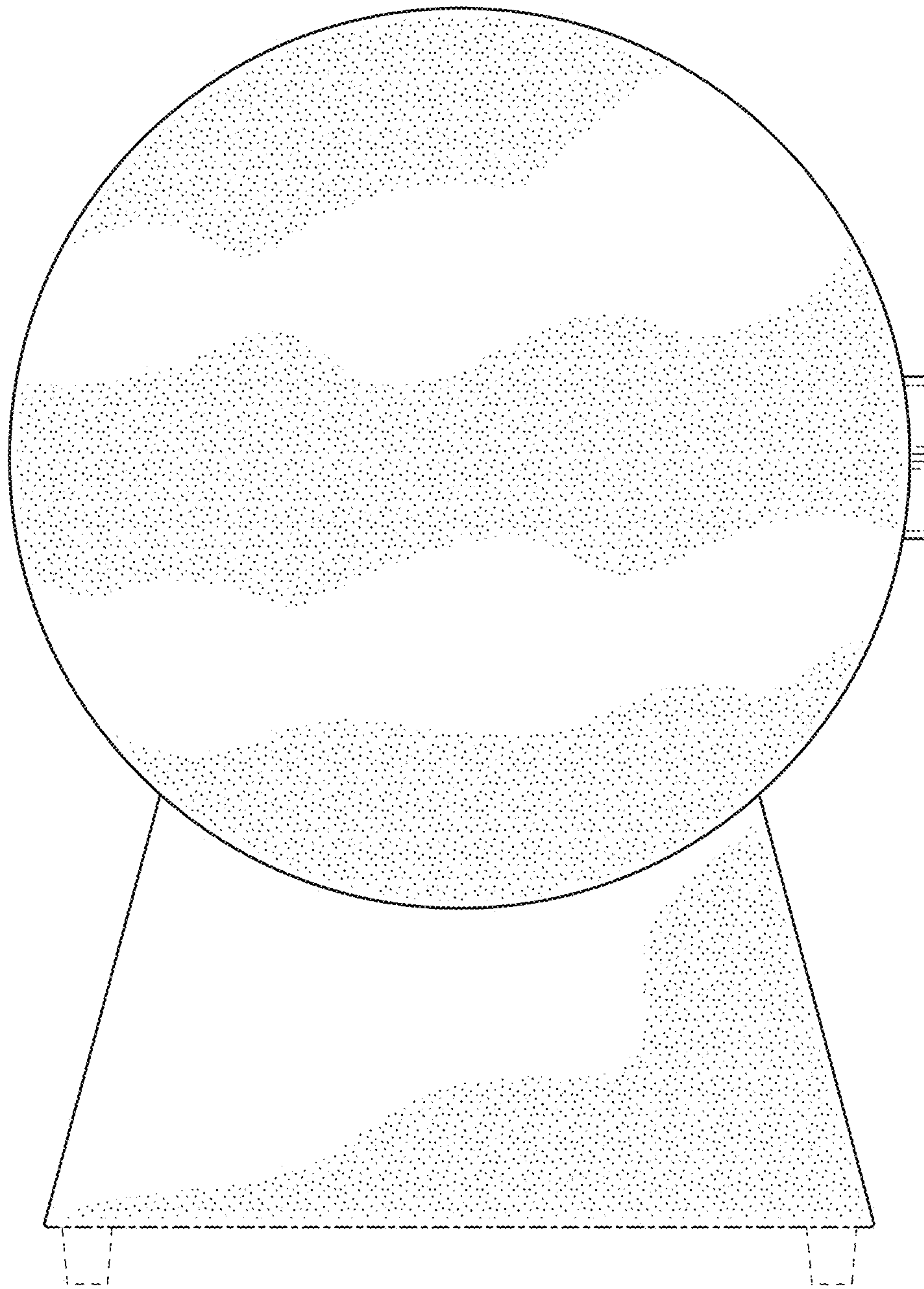

FIG. 24

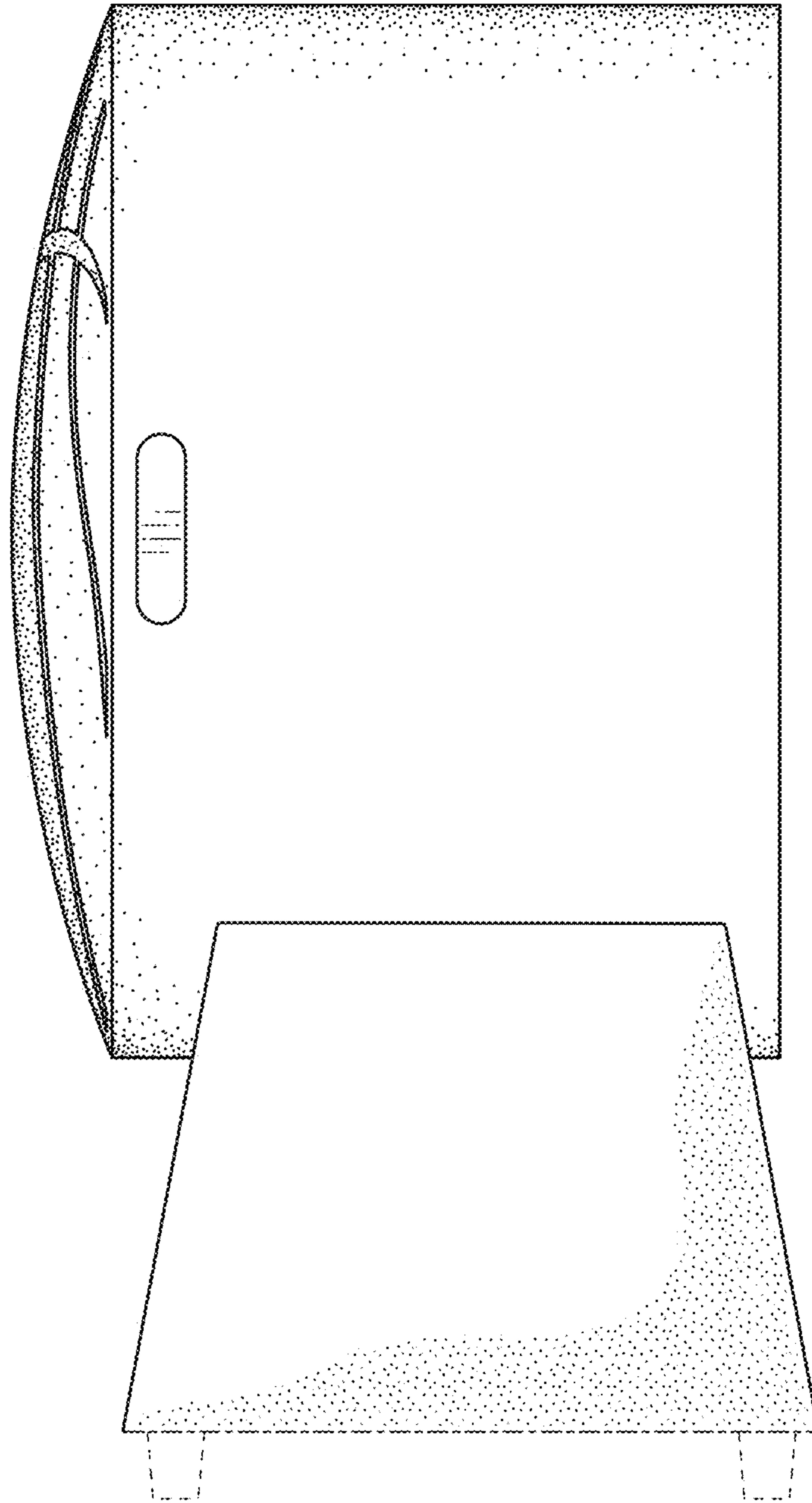

FIG. 25

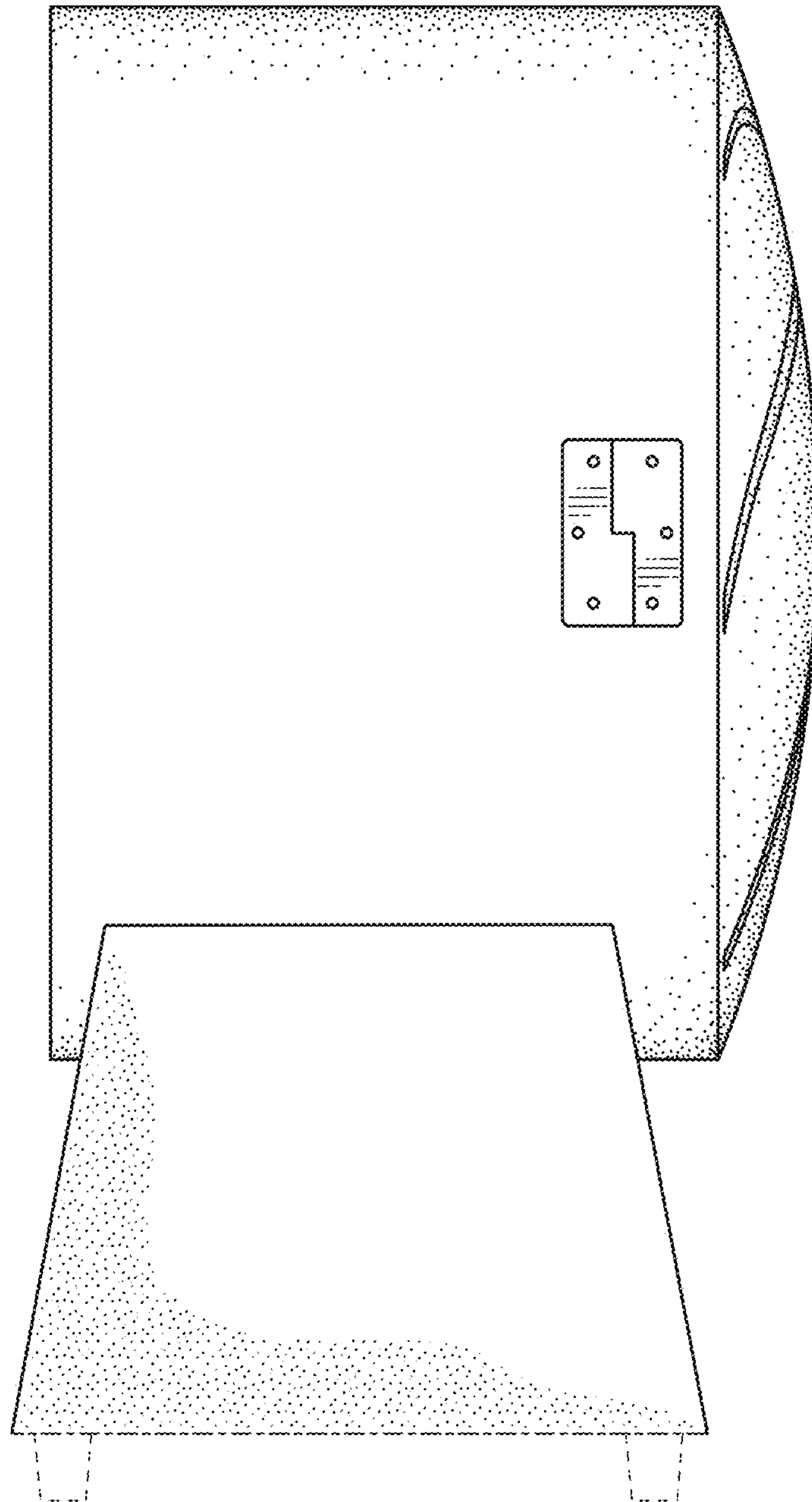

FIG. 26

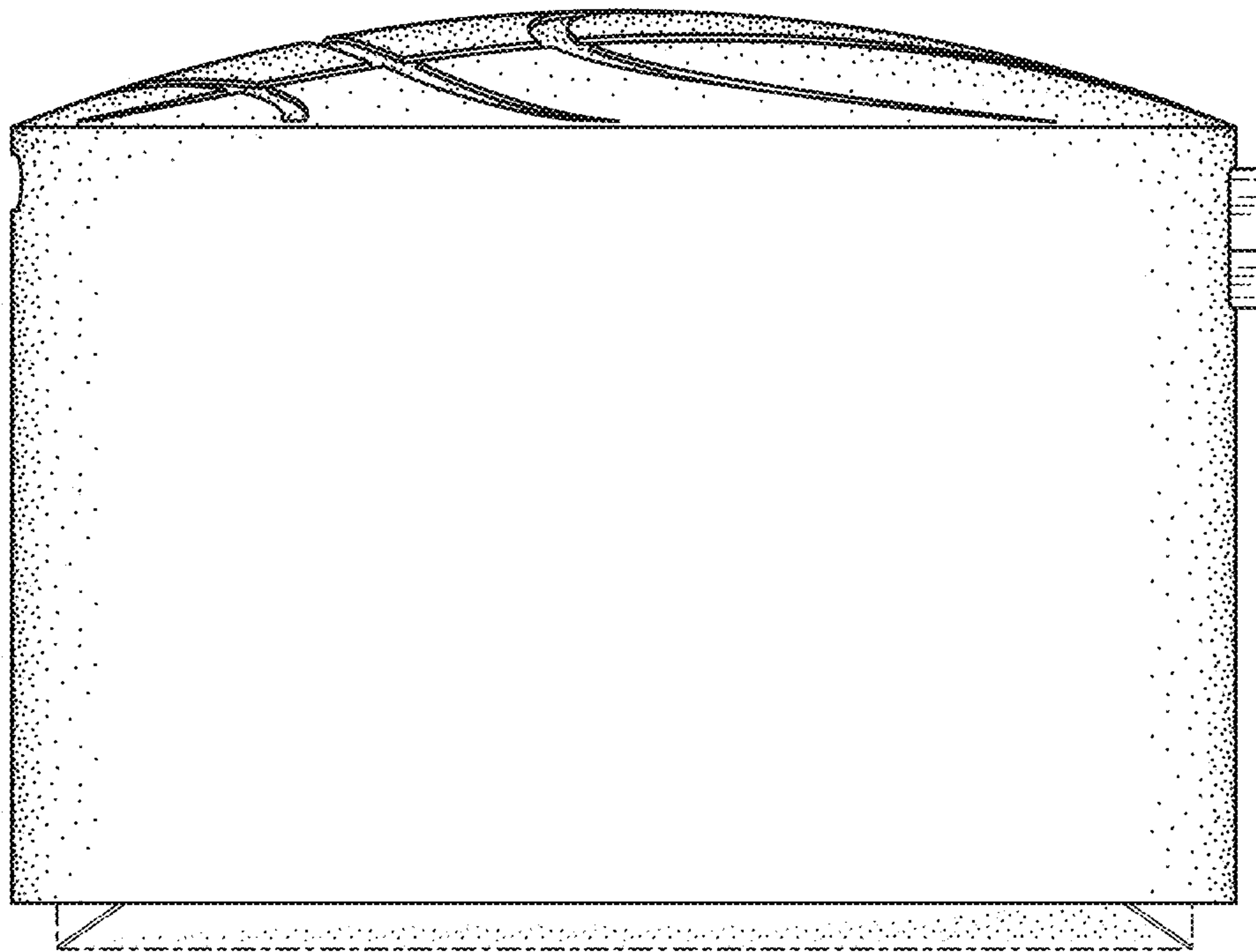

FIG. 27

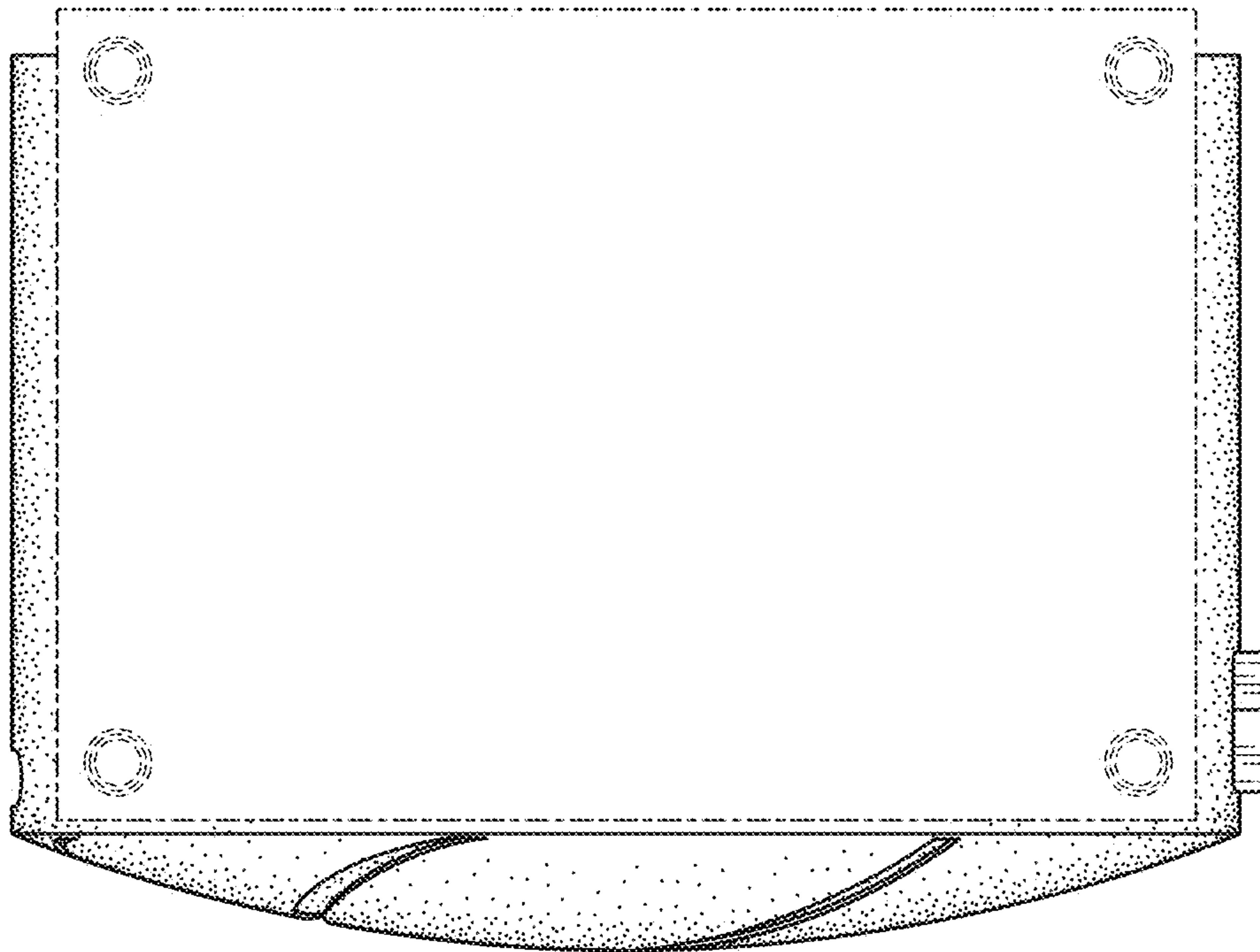

FIG. 28