



US00D933665S

(12) **United States Design Patent**
Ke

(10) **Patent No.:** **US D933,665 S**
(45) **Date of Patent:** **** Oct. 19, 2021**

(54) **CASE FOR A TABLET COMPUTER**

(71) Applicant: **Huazhe Ke**, Guangdong (CN)

(72) Inventor: **Huazhe Ke**, Guangdong (CN)

(**) Term: **15 Years**

(21) Appl. No.: **29/711,827**

(22) Filed: **Nov. 3, 2019**

(51) **LOC (13) Cl.** **14-02**

(52) **U.S. Cl.**
USPC **D14/440**

(58) **Field of Classification Search**
USPC D14/217, 238.1, 240, 248, 250, 251–253,
D14/439, 440, 447; D13/107–108, 103,
D13/119; D3/201, 218, 247, 269, 273,
D3/301, 303
CPC H04B 1/3888; H04M 1/0283; H04M
1/0202; A45C 1/06; A45C 11/00; A45C
13/02; A45C 2011/002; A45F 2005/026;
A45F 2200/0525; A45F 2200/0516
See application file for complete search history.

(56) **References Cited**

U.S. PATENT DOCUMENTS

D786,881 S	*	5/2017	Stewart	D14/440
D806,083 S	*	12/2017	Armstrong	D14/440
D830,368 S	*	10/2018	Zhang	D14/440
D851,092 S	*	6/2019	Tan	D14/440
D851,649 S	*	6/2019	Tan	D14/440
D852,802 S	*	7/2019	Gao	D14/440
D868,790 S	*	12/2019	Weng	D14/440

D874,467 S	*	2/2020	Piper	D14/440
D879,788 S	*	3/2020	Gao	D14/440
D883,987 S	*	5/2020	Cheng	D14/440
D891,435 S	*	7/2020	Cheng	D14/440
D898,034 S	*	10/2020	Cheng	D14/440
D898,036 S	*	10/2020	Cheng	D14/440

OTHER PUBLICATIONS

“Timecity iPad 10.2 Case [. . .]” [online]. Timecity. [Product first available on Sep. 29, 2019]. Retrieved from the Internet: <<https://www.amazon.com/dp/B07YHT4VFP>>.*

* cited by examiner

Primary Examiner — Mojtaba Tehrani

(57) **CLAIM**

The ornamental design for a case for a tablet computer, as shown and described.

DESCRIPTION

FIG. 1 is a perspective view of a case for a tablet computer showing my new design;
FIG. 2 is a front elevation view thereof;
FIG. 3 is a rear elevation view thereof;
FIG. 4 is a left side elevation view thereof;
FIG. 5 is a right side elevation view thereof;
FIG. 6 is a top plan view thereof; and,
FIG. 7 is a bottom plan view thereof.
The broken lines in the drawings depicts unclaimed portion of the case only and forms no part of the claimed design.

1 Claim, 7 Drawing Sheets

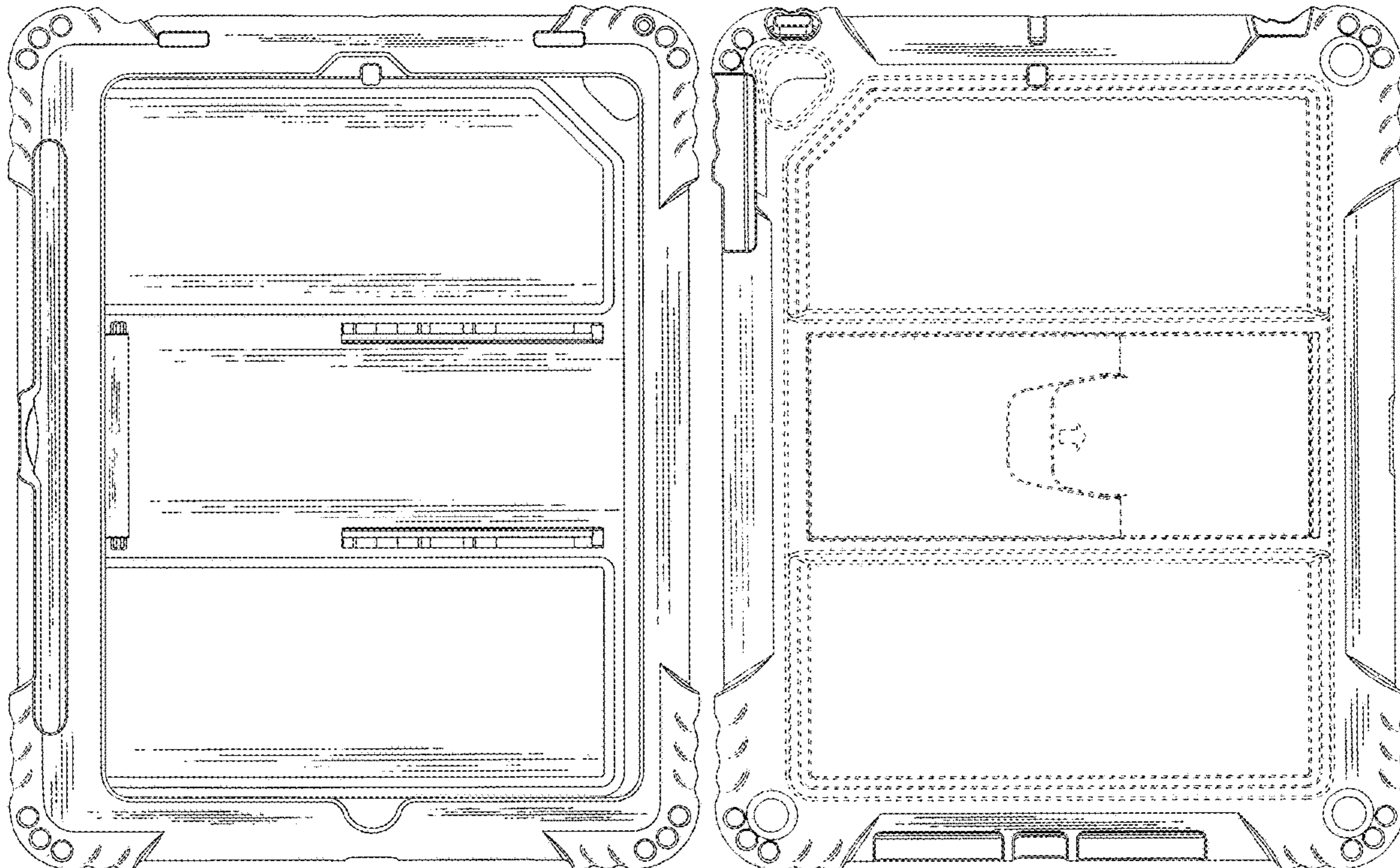

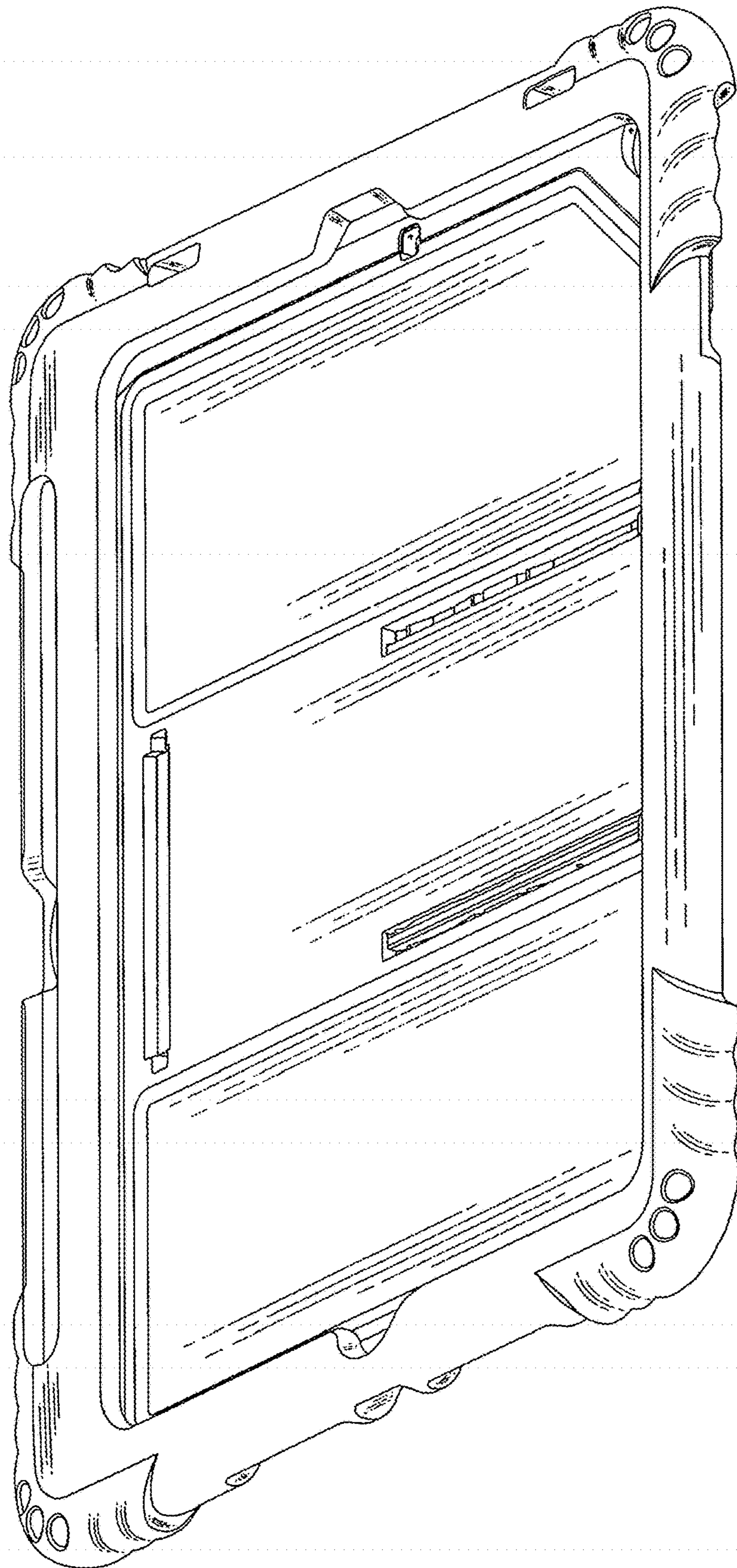

FIG. 1

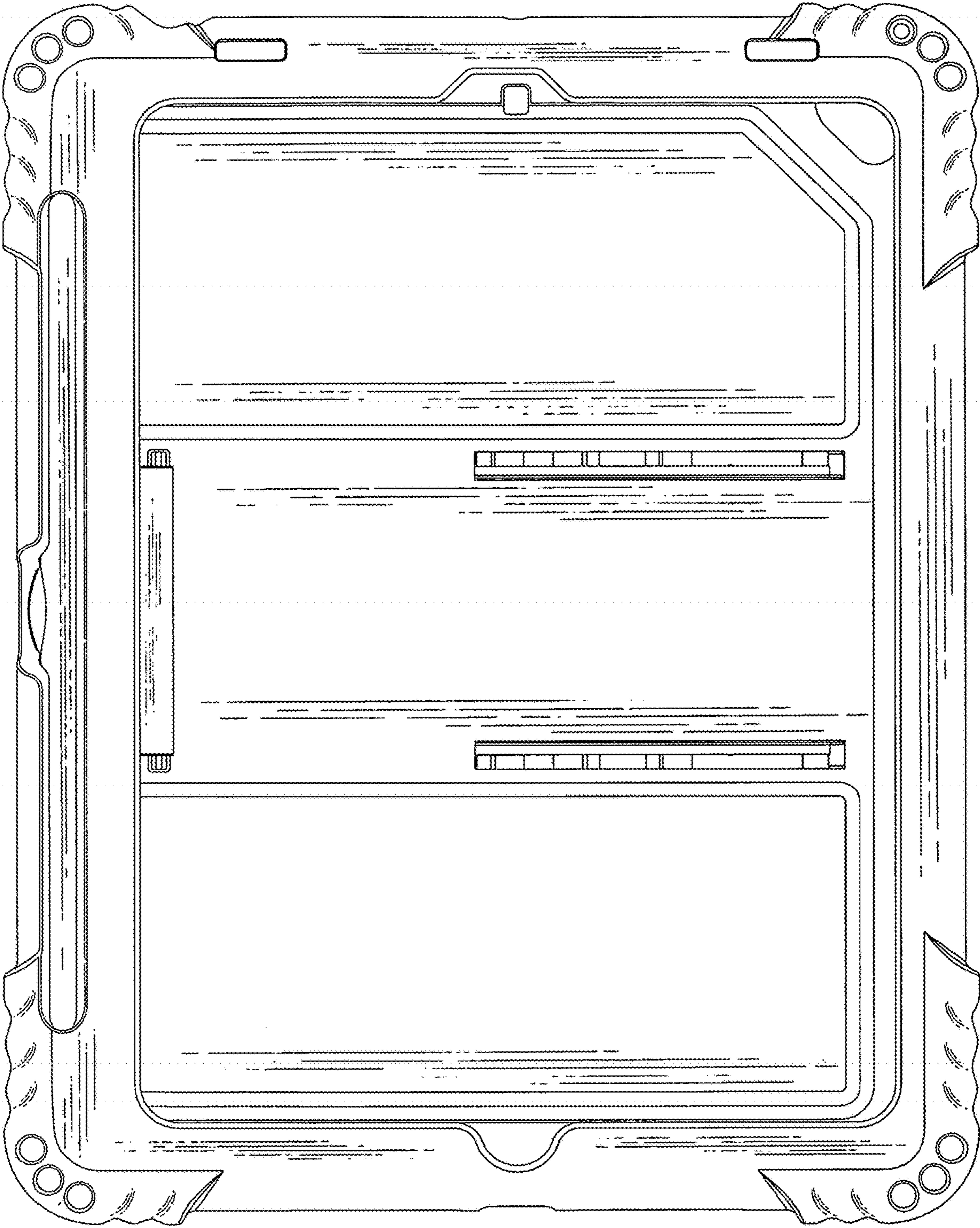

FIG. 2

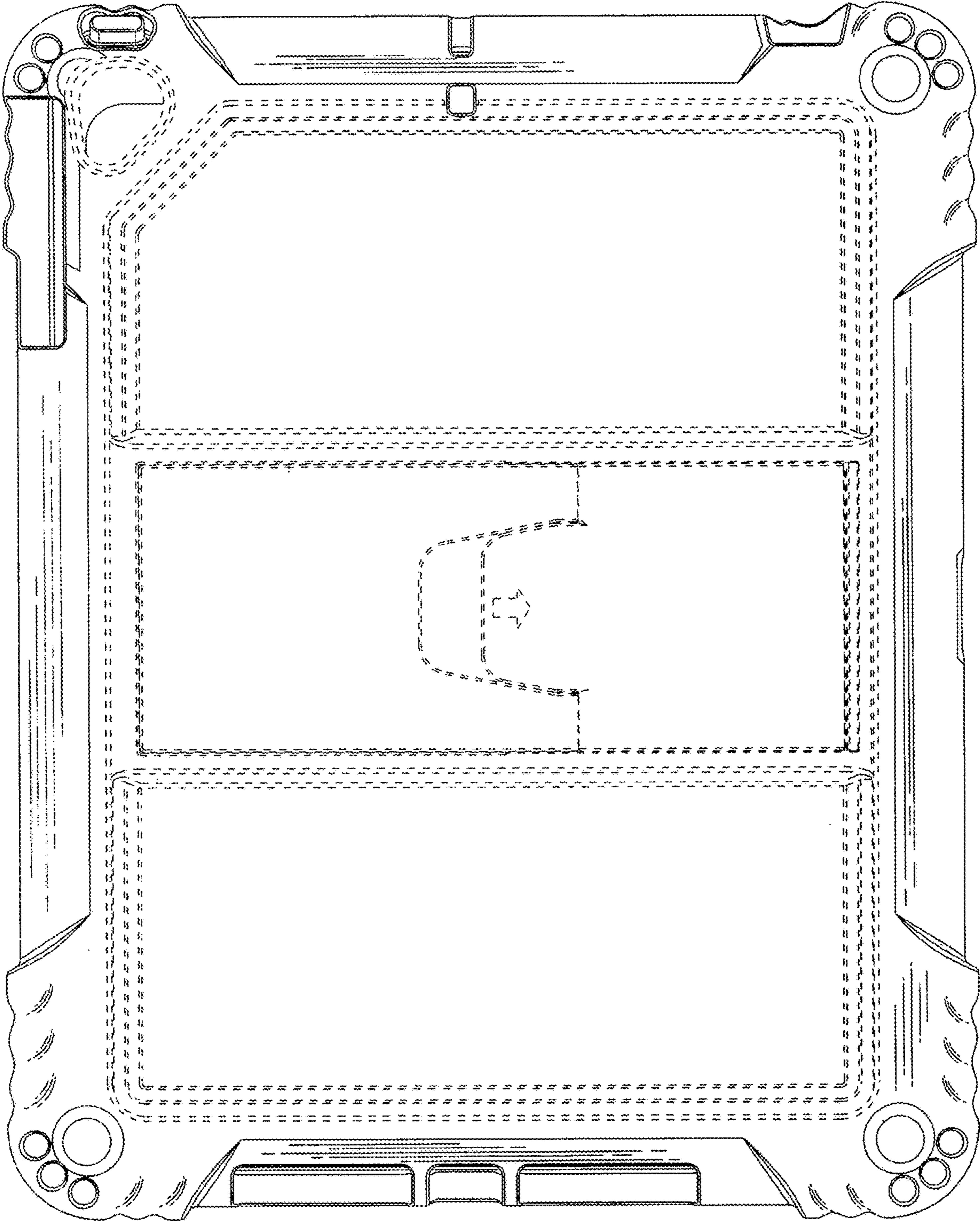

FIG. 3

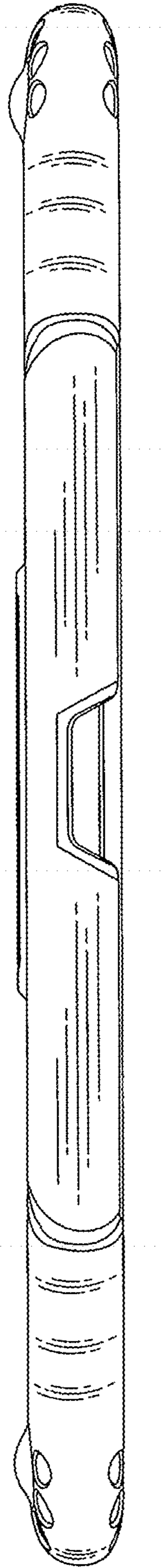

FIG. 4

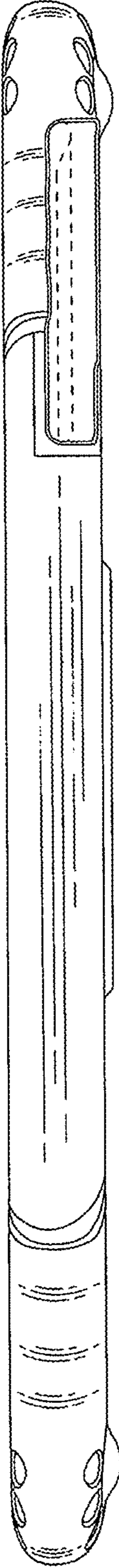

FIG. 5

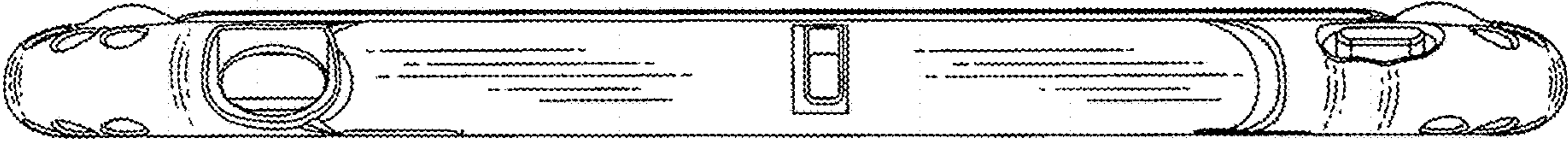

FIG.6

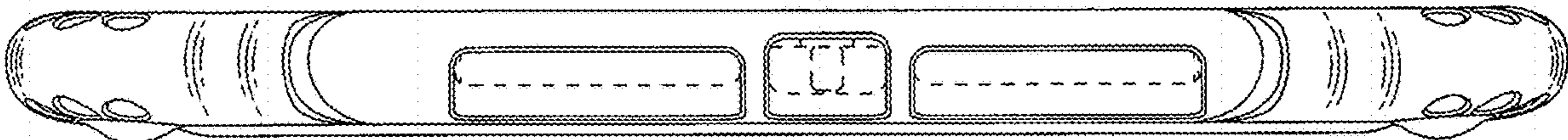

FIG. 7