



US00D933602S

(12) **United States Design Patent**
Zhang

(10) **Patent No.:** **US D933,602 S**

(45) **Date of Patent:** **** Oct. 19, 2021**

- (54) **EARBUDS CHARGING CASE**
- (71) Applicant: **Shenzhen LeyuSmart Technology Co., Ltd, Guangdong (CN)**
- (72) Inventor: **XinBin Zhang, Puning (CN)**
- (73) Assignee: **Shenzhen LeyuSmart Technology Co., Ltd.**
- (**) Term: **15 Years**
- (21) Appl. No.: **29/765,009**
- (22) Filed: **Jan. 5, 2021**
- (51) **LOC (13) Cl.** **13-02**
- (52) **U.S. Cl.**
USPC **D13/108; D3/294**
- (58) **Field of Classification Search**
USPC D13/103, 107–110, 118–119, 184, 199;
D14/251, 253, 432, 434, 433; D3/201,
D3/205, 208, 218, 273, 274, 294
CPC H02J 7/025; H02J 7/005; H02J 7/0026;
H02J 7/0042; H02J 7/0044; H02J 7/0045;
H02J 7/0013; H02J 7/0003; H02J 50/00;
H02J 50/10; H02J 50/12; H02J 50/80
See application file for complete search history.

(56) **References Cited**

U.S. PATENT DOCUMENTS

D708,850 S *	7/2014	Morine	D3/294
D738,110 S	9/2015	Jiang et al.		
D750,179 S	2/2016	Foulkes et al.		
D804,806 S	12/2017	Stueckemann et al.		
D832,208 S *	10/2018	Grois	D13/108
D838,480 S	1/2019	Son et al.		
D841,580 S *	2/2019	Bao	D13/108
D841,581 S *	2/2019	Bonahoom	D13/108
D846,264 S	4/2019	Wu		
D853,116 S *	7/2019	Bergman	D3/294

D874,142 S	2/2020	Anderson		
D876,834 S	3/2020	Breen et al.		
D878,048 S *	3/2020	Wang	D3/294
D887,351 S *	6/2020	Bonahoom	D13/108
D888,423 S *	6/2020	Chen	D3/274
D890,696 S	7/2020	Sweet		
D897,291 S	9/2020	Akana		
10,778,021 B1 *	9/2020	Alexander	H02J 7/0044
D902,589 S *	11/2020	Li	D3/295
D904,761 S *	12/2020	Koneru	D3/274
D904,762 S *	12/2020	Koneru	D3/274
D904,763 S *	12/2020	Koneru	D3/274
D908,084 S *	1/2021	He	D13/108
D908,617 S *	1/2021	Briggs	D13/108
D911,945 S *	3/2021	Xian	D13/108
D912,623 S *	3/2021	Zhou	D13/108
D913,223 S *	3/2021	Li	D13/108
D913,224 S *	3/2021	Kim	D13/108
D921,582 S *	6/2021	Liu	D13/108
D924,798 S *	7/2021	Ando	D13/108
2020/0304899 A1 *	9/2020	Cramer	H02J 7/0042

* cited by examiner

Primary Examiner — Rosemary K Tarcza

(57) **CLAIM**

The ornamental design for an earbuds charging case, as shown and described.

DESCRIPTION

FIG. 1 is a front view of the earbuds charging case showing my new design;
 FIG. 2 is a back view thereof;
 FIG. 3 is a left side view thereof;
 FIG. 4 is a right side view thereof;
 FIG. 5 is a top view thereof;
 FIG. 6 is a bottom view thereof;
 FIG. 7 is a perspective view thereof; and
 FIG. 8 is another perspective view thereof; and,
 FIG. 9 is another perspective view thereof.

1 Claim, 9 Drawing Sheets

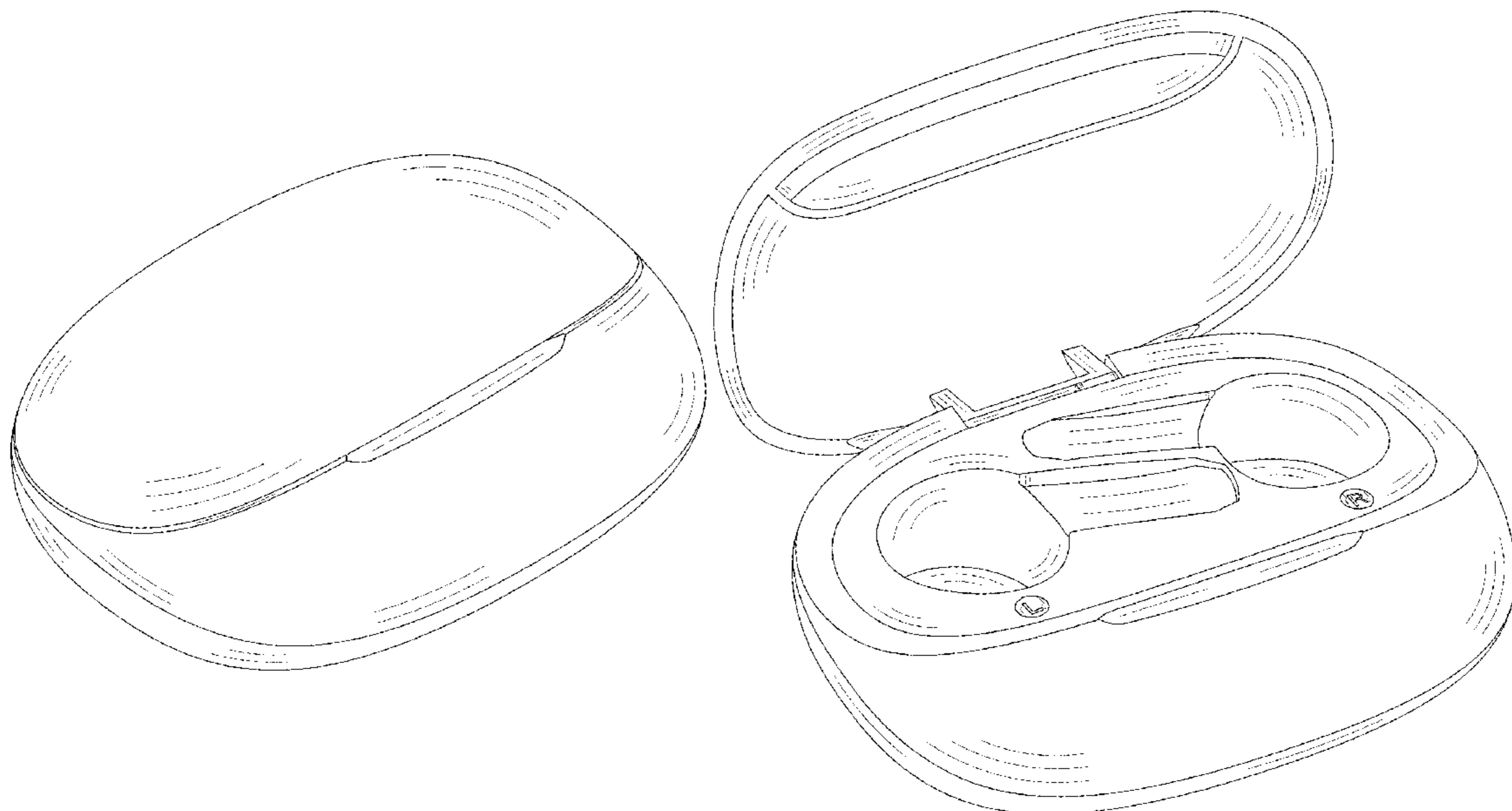

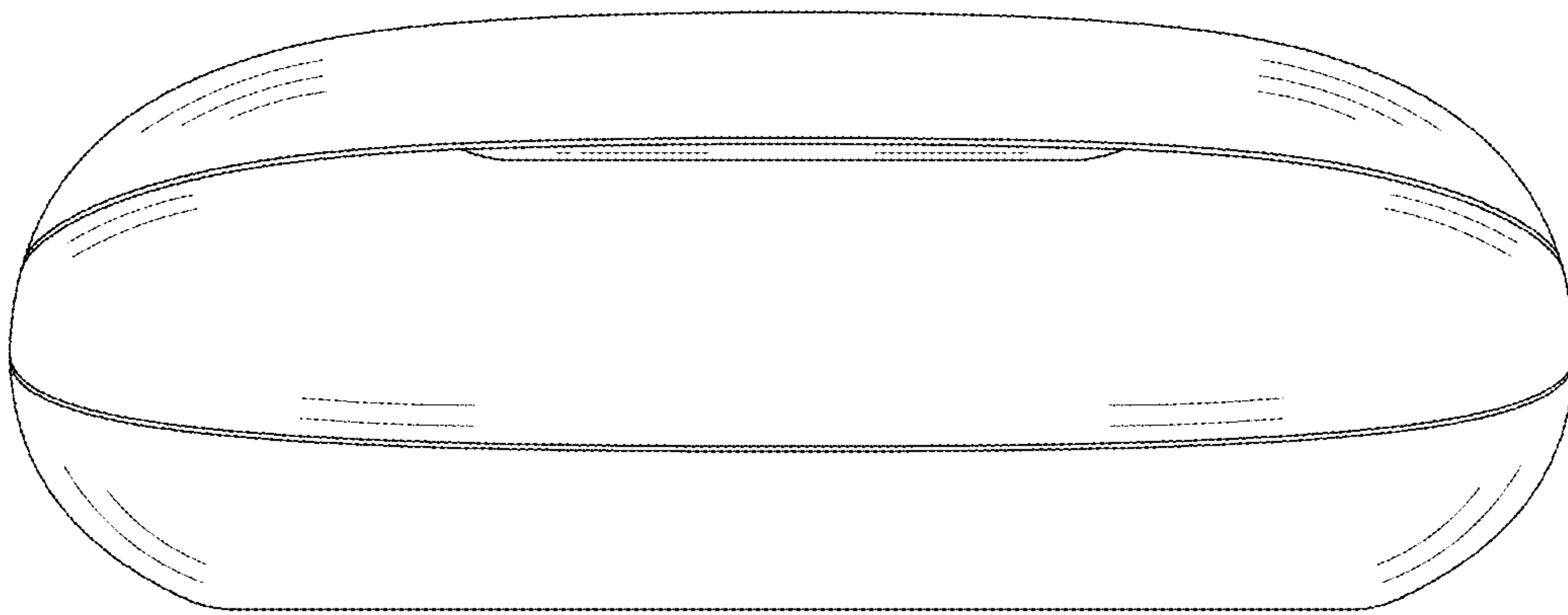

FIG. 1

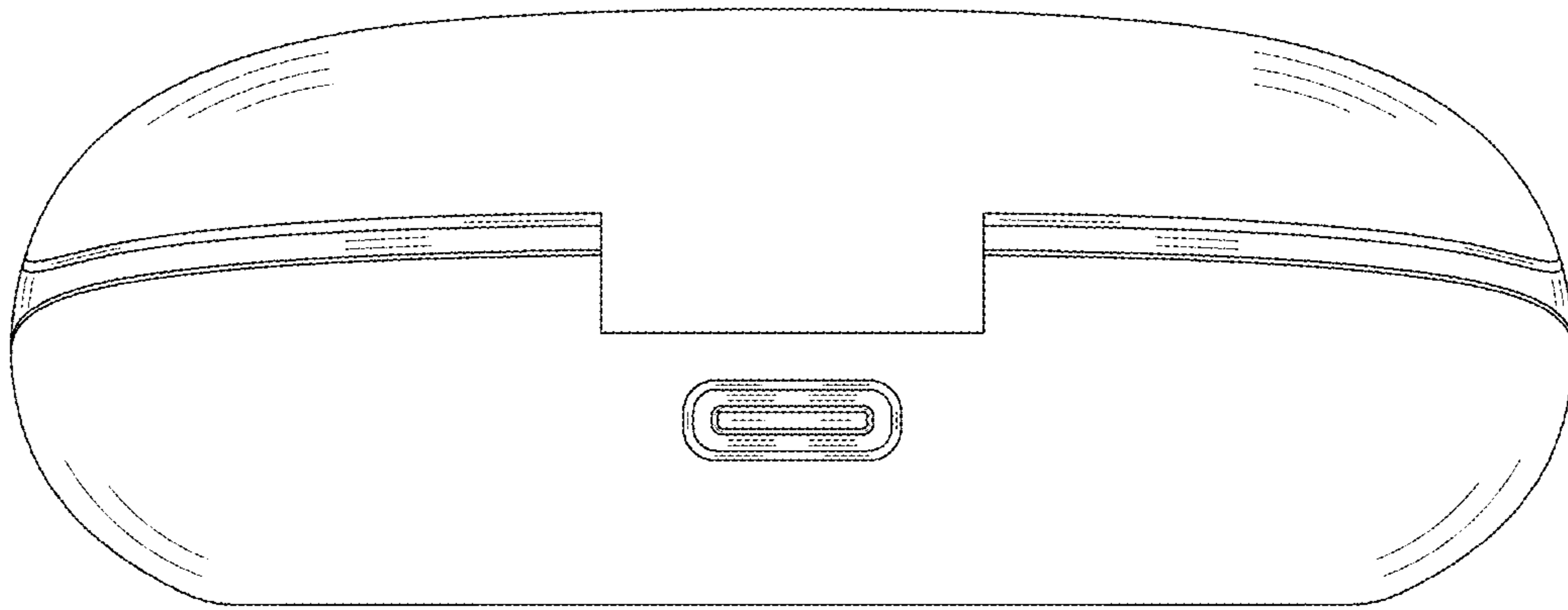

FIG. 2

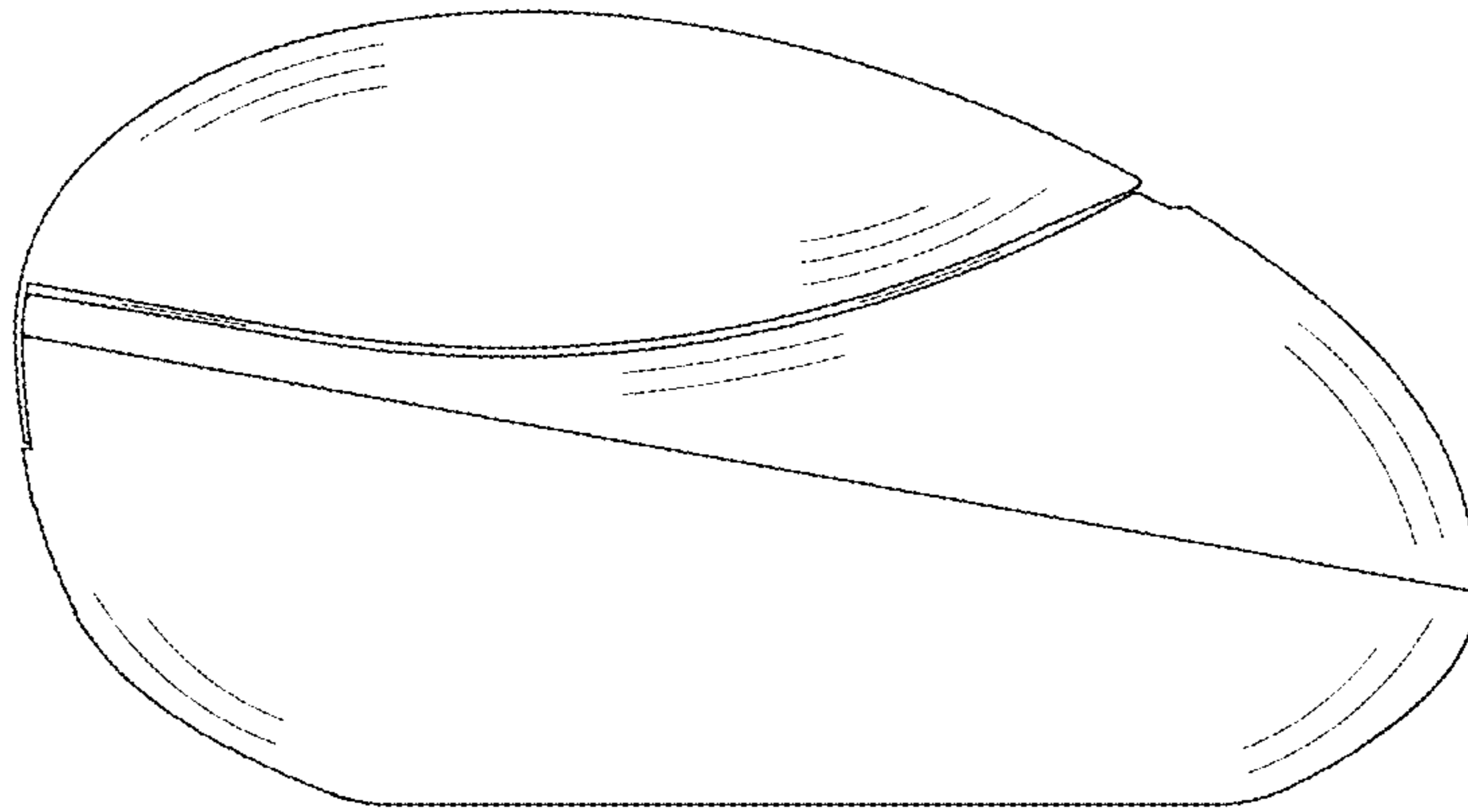

FIG. 3

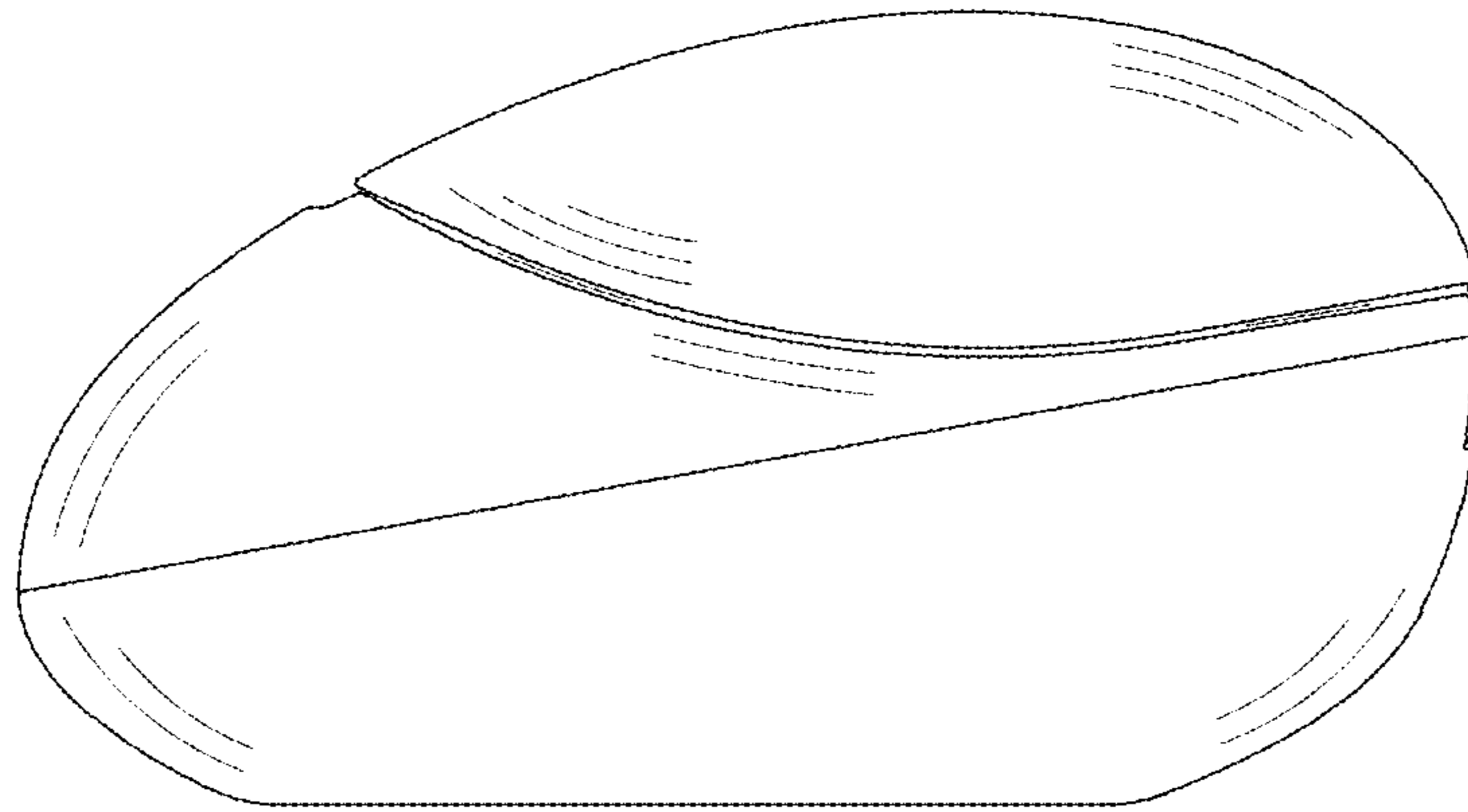

FIG. 4

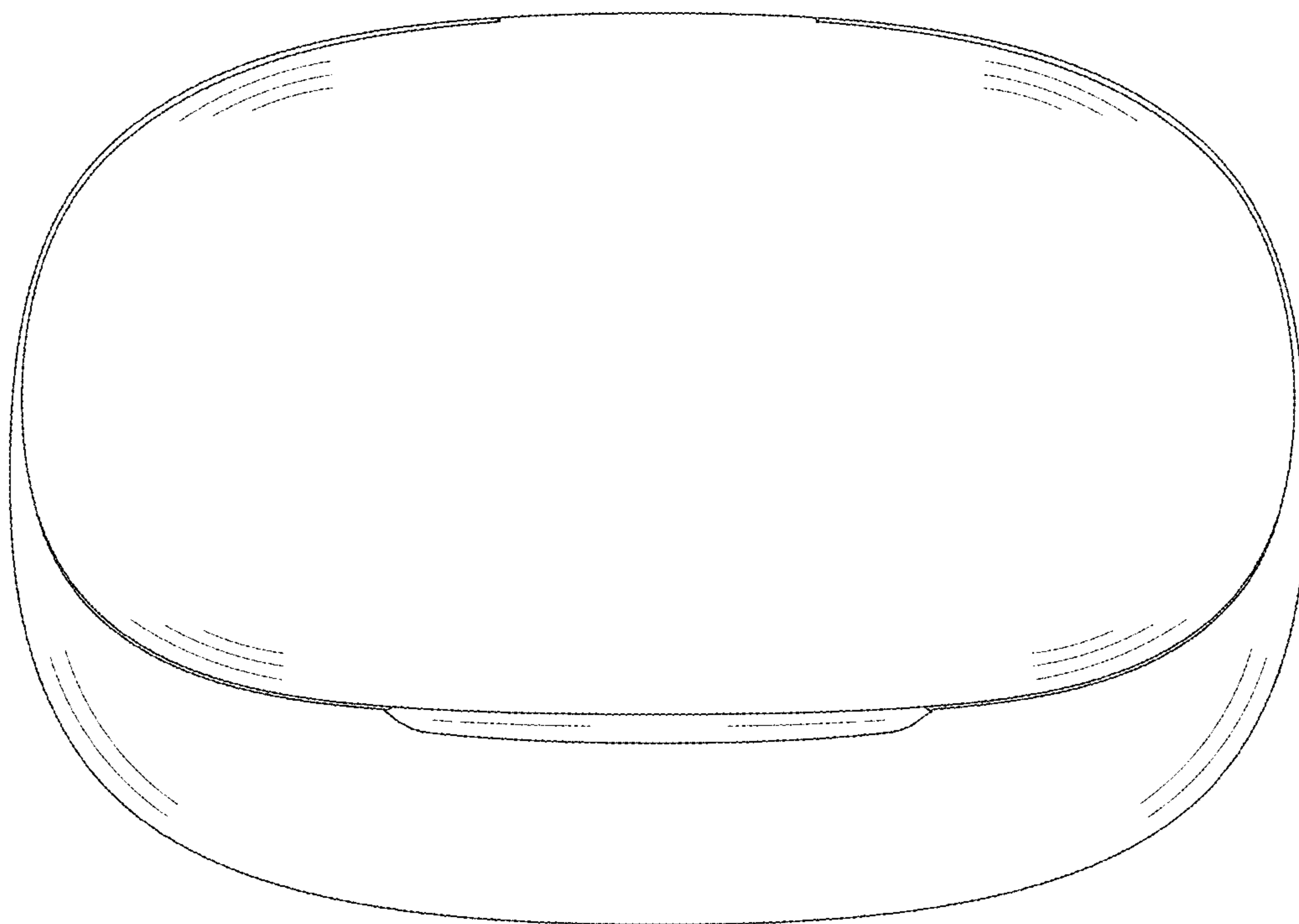

FIG. 5

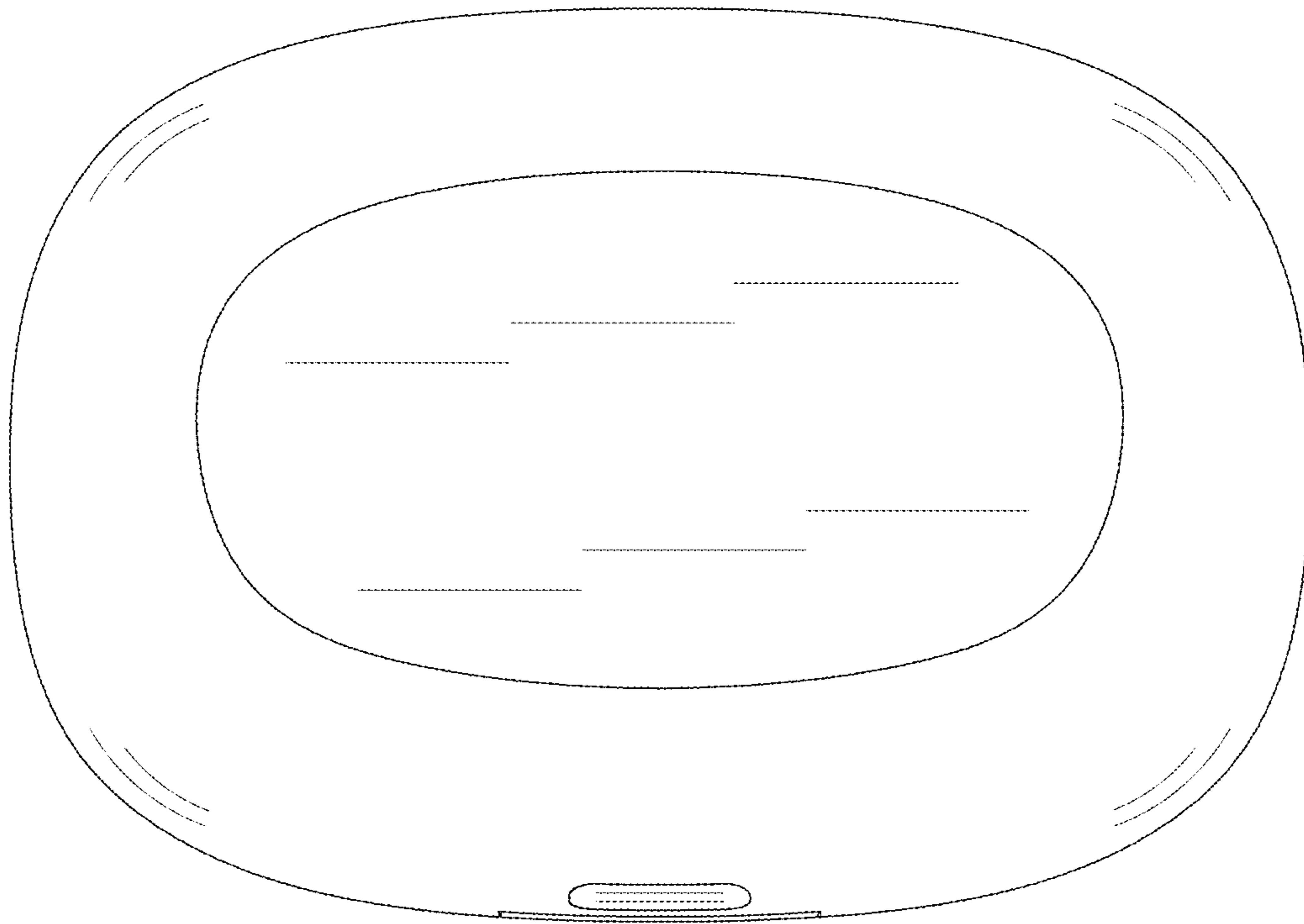

FIG. 6

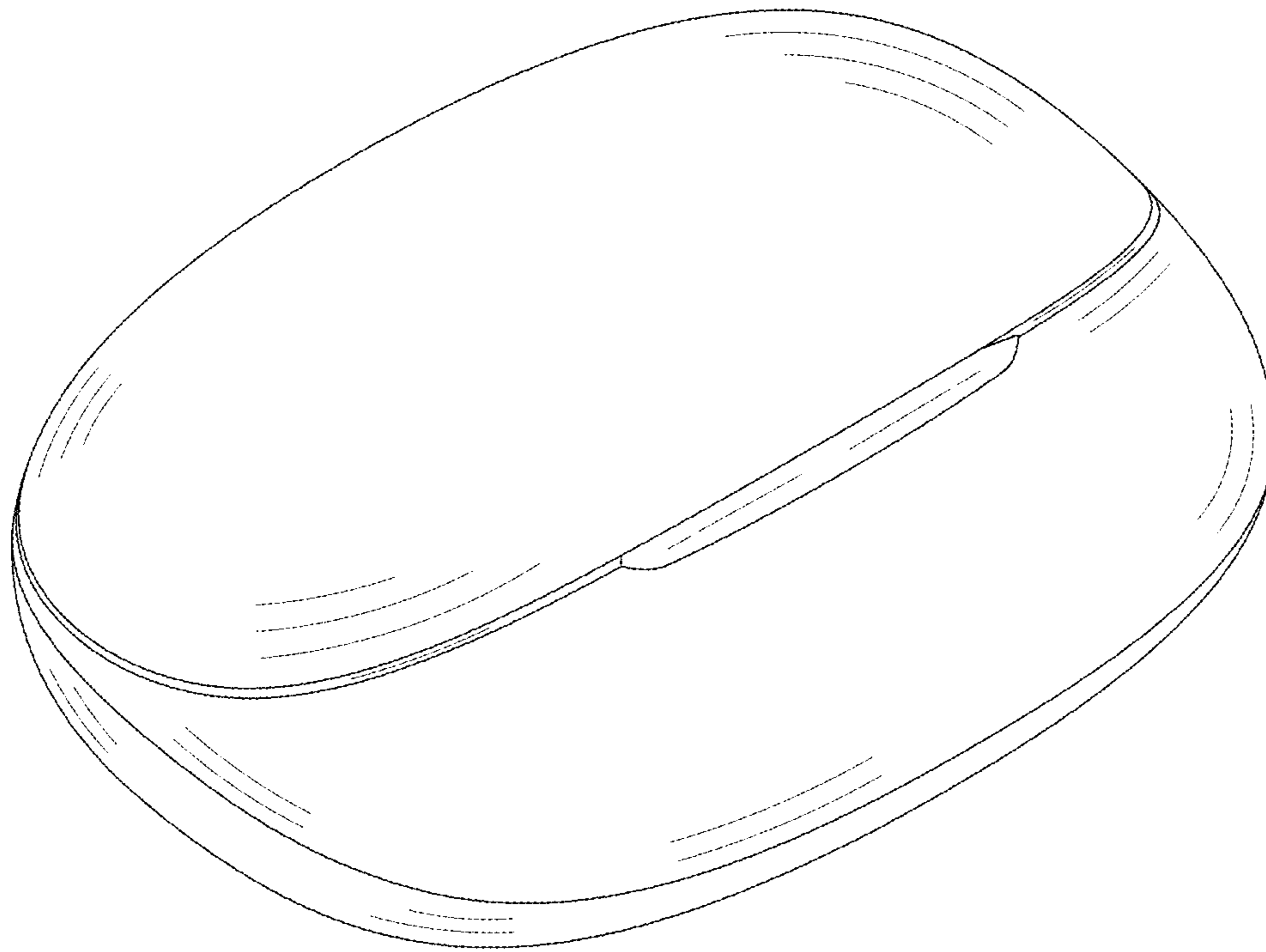

FIG. 7

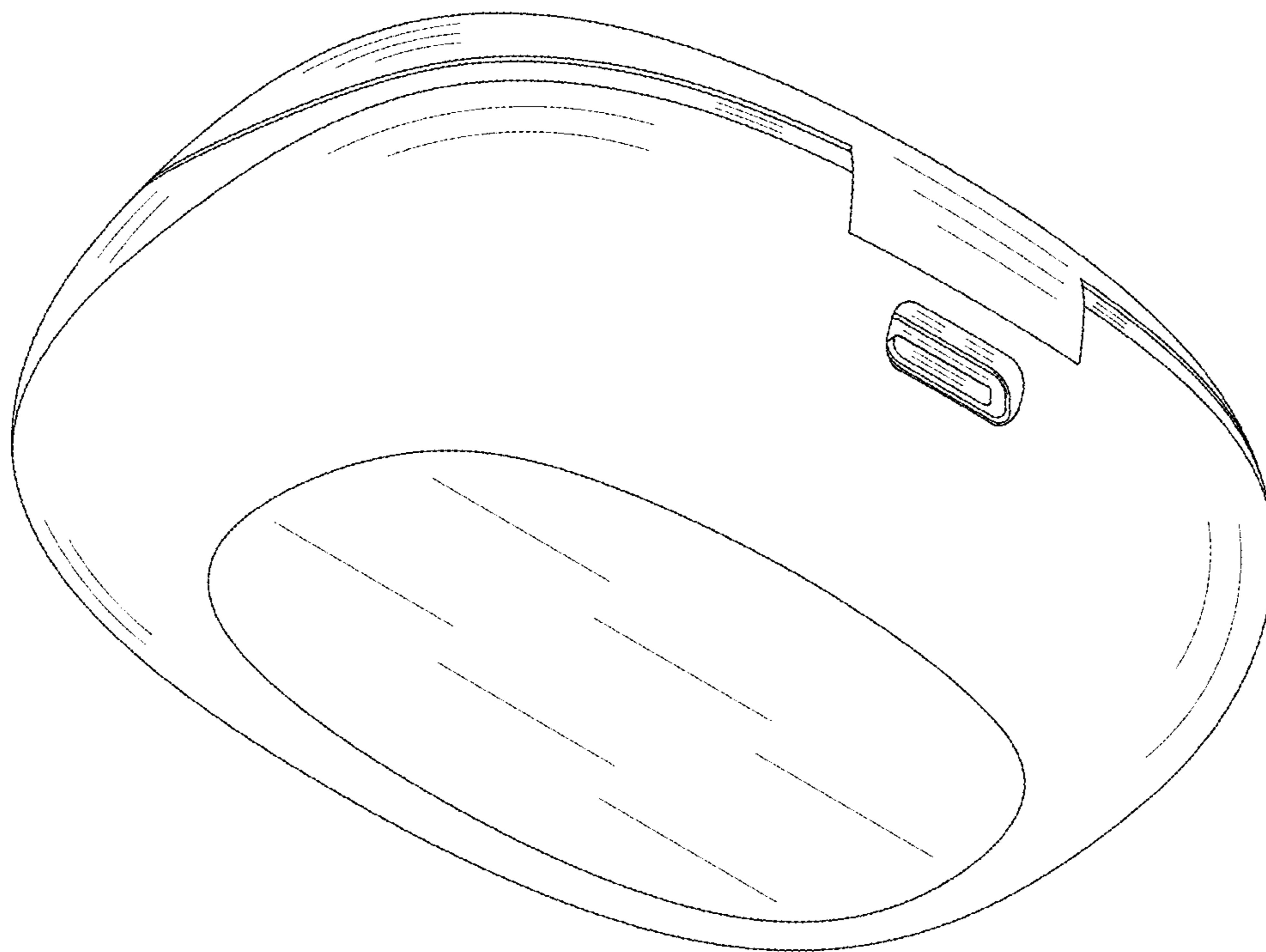

FIG. 8

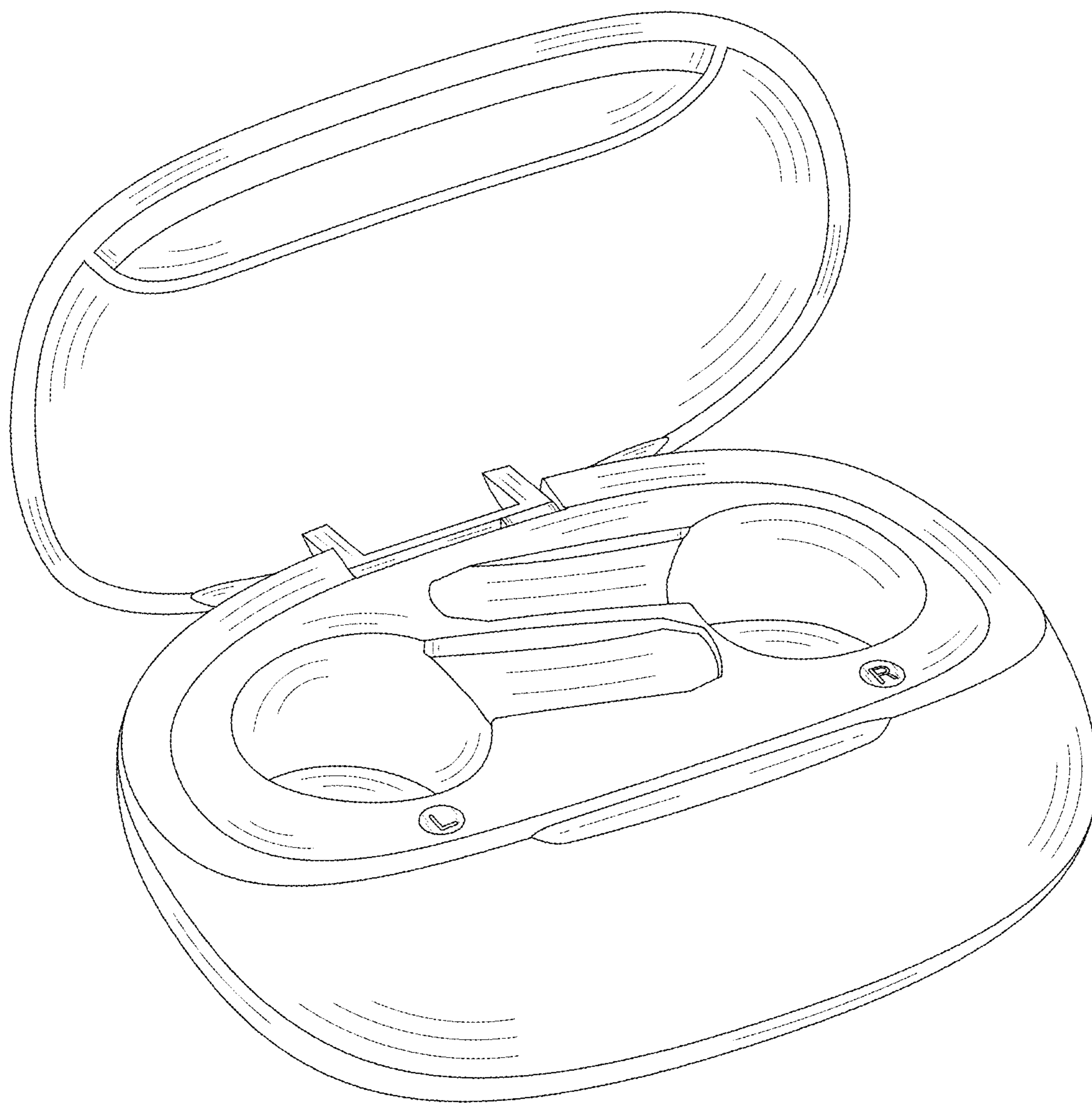

FIG. 9