



US00D933565S

(12) **United States Design Patent**
Tovey et al.

(10) **Patent No.:** **US D933,565 S**

(45) **Date of Patent:** **** Oct. 19, 2021**

(54) **VEHICLE WHEEL**

(71) Applicant: **JAGUAR LAND ROVER LIMITED,**
Coventry (GB)

(72) Inventors: **Simon Tovey,** Coventry (GB); **Anthony Peat,** Coventry (GB)

(73) Assignee: **JAGUAR LAND ROVER LIMITED,**
Coventry (GB)

(**) Term: **15 Years**

(21) Appl. No.: **29/743,744**

(22) Filed: **Jul. 23, 2020**

(30) **Foreign Application Priority Data**

Jan. 24, 2020 (EM) 007551957-0009

(51) **LOC (13) Cl.** **12-16**

(52) **U.S. Cl.**
USPC **D12/209**

(58) **Field of Classification Search**

USPC D12/204–213; D21/563
CPC B60B 7/00; B60B 7/02; B60B 7/04; B60B
7/01; B60B 7/06; B60B 3/02; B60B 3/04;
B60B 3/06; B60B 3/10; B60B 1/00;
B60B 1/08; B60B 1/10; B60B 1/12

See application file for complete search history.

(56) **References Cited**

U.S. PATENT DOCUMENTS

D594,396 S * 6/2009 Juergens D12/209
D635,904 S * 4/2011 Futschik D12/209

D641,679 S * 7/2011 Vardis D12/211
D677,209 S * 3/2013 Kono D12/211
D693,284 S * 11/2013 Chen D12/211
D704,120 S * 5/2014 Feuerherdt D12/211
D715,715 S * 10/2014 Pollmann D12/209
D727,232 S * 4/2015 Frei D12/209
D734,701 S * 7/2015 Mielke D12/209
D746,752 S * 1/2016 Beaven D12/209
D759,563 S * 6/2016 Setter D12/209
D840,897 S * 2/2019 Aiba D12/209
D890,060 S * 7/2020 Buttigieg D12/209
D895,512 S * 9/2020 Patel D12/209
D911,907 S * 3/2021 Li D12/209

* cited by examiner

Primary Examiner — Stacia A Cadmus

(74) *Attorney, Agent, or Firm* — Reising Ethington P.C.

(57) **CLAIM**

The ornamental design for a vehicle wheel, as shown and described.

DESCRIPTION

FIG. 1 is a frontside perspective view of the vehicle wheel;
FIG. 2 is a rear side perspective view thereof;
FIG. 3 is a front view thereof;
FIG. 4 is a rear view thereof;
FIG. 5 is a left side view thereof;
FIG. 6 is a right side view thereof;
FIG. 7 is a top view thereof; and,
FIG. 8 is a bottom view thereof.

The broken lines shown in the drawings depict portions of the vehicle wheel that form no part of the claimed design.

1 Claim, 8 Drawing Sheets

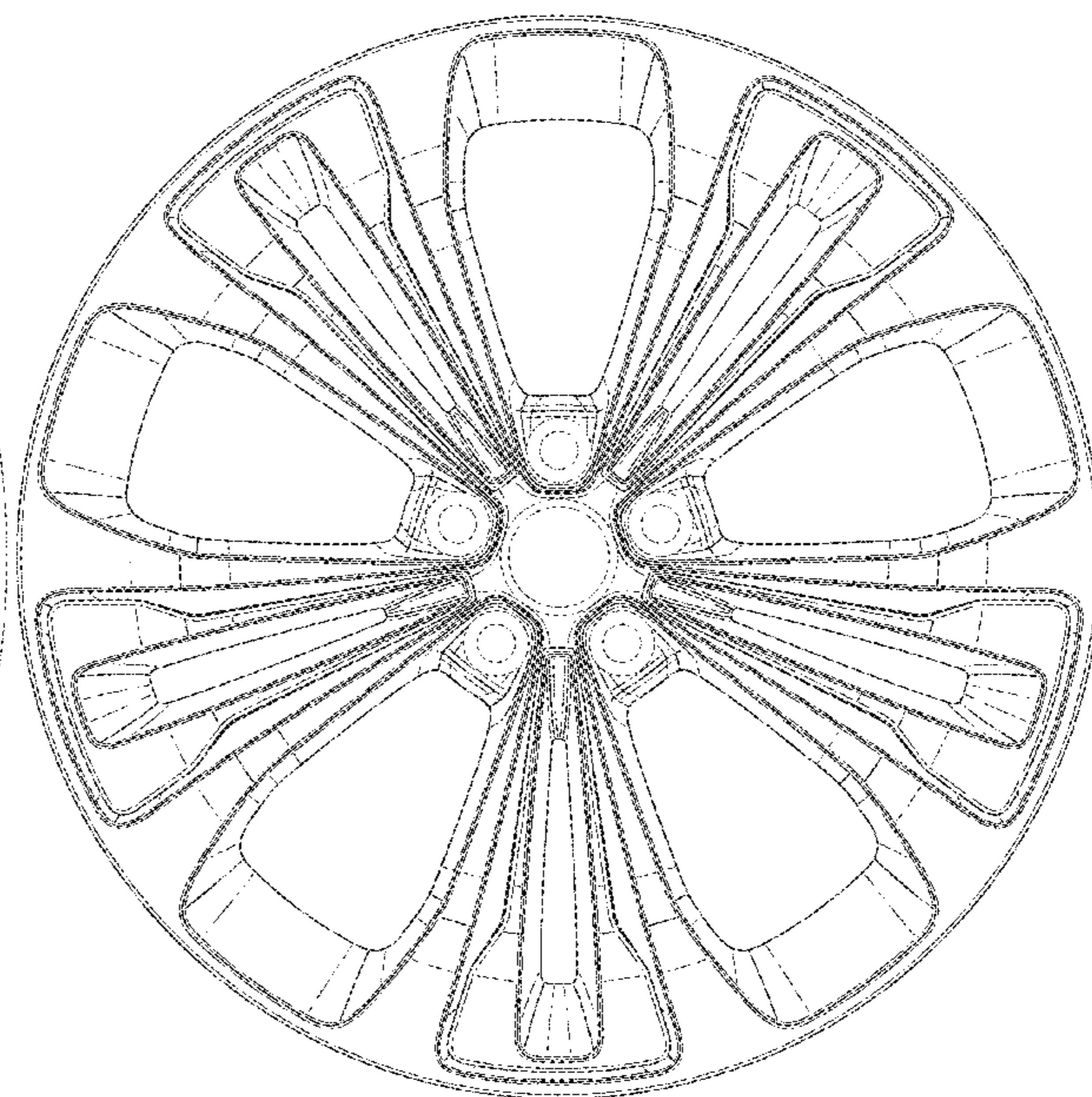
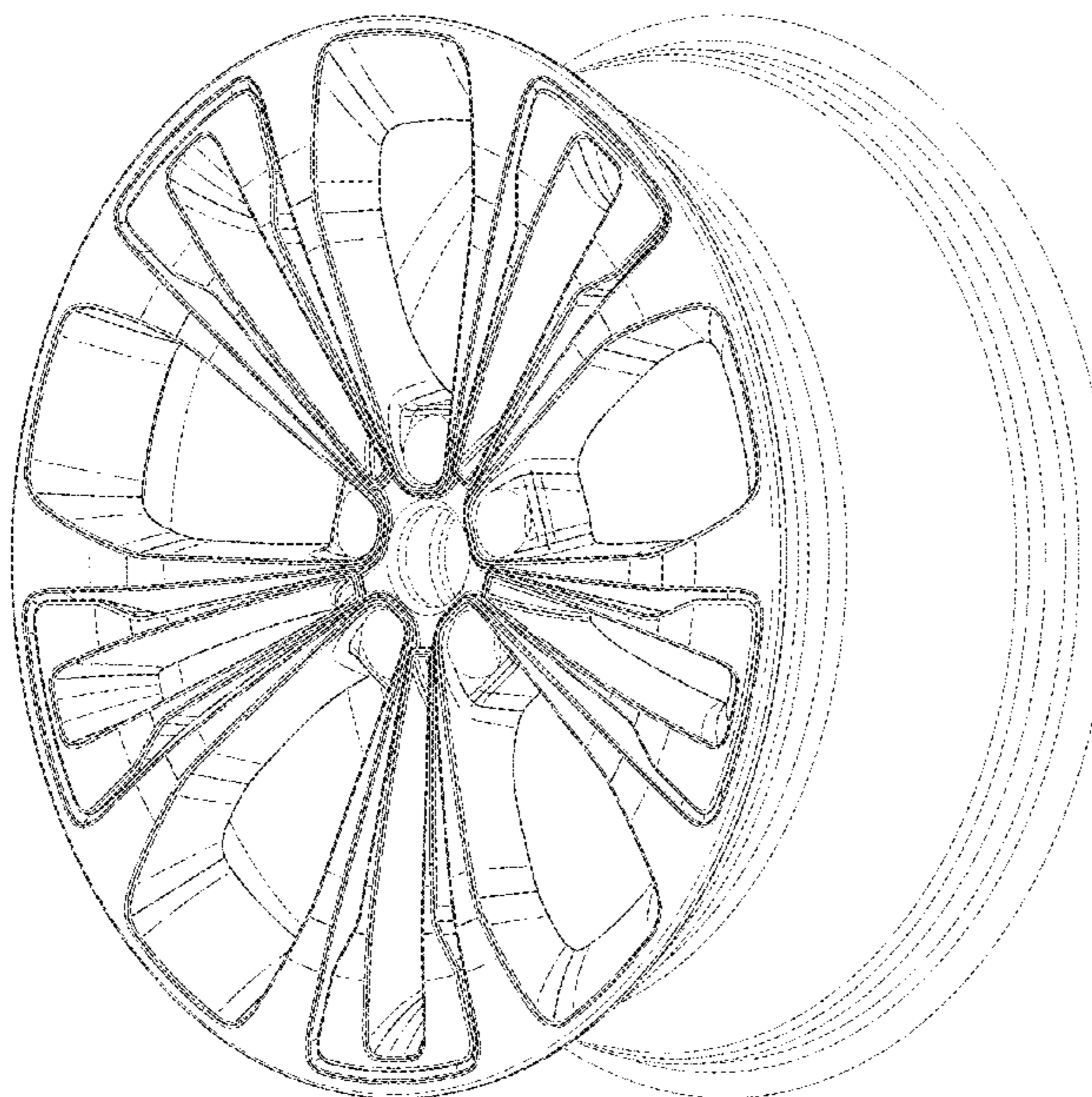

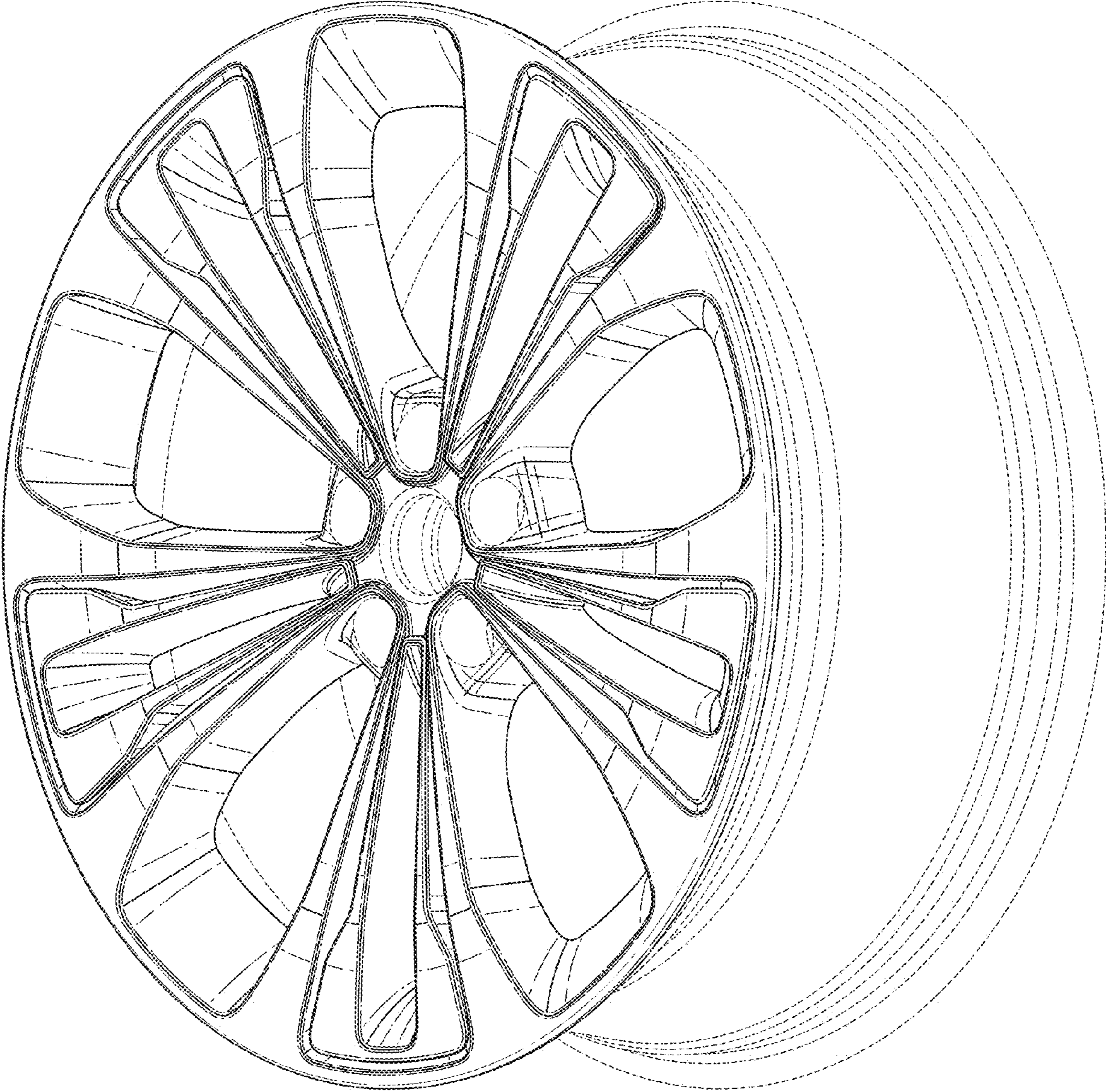

FIG. 1

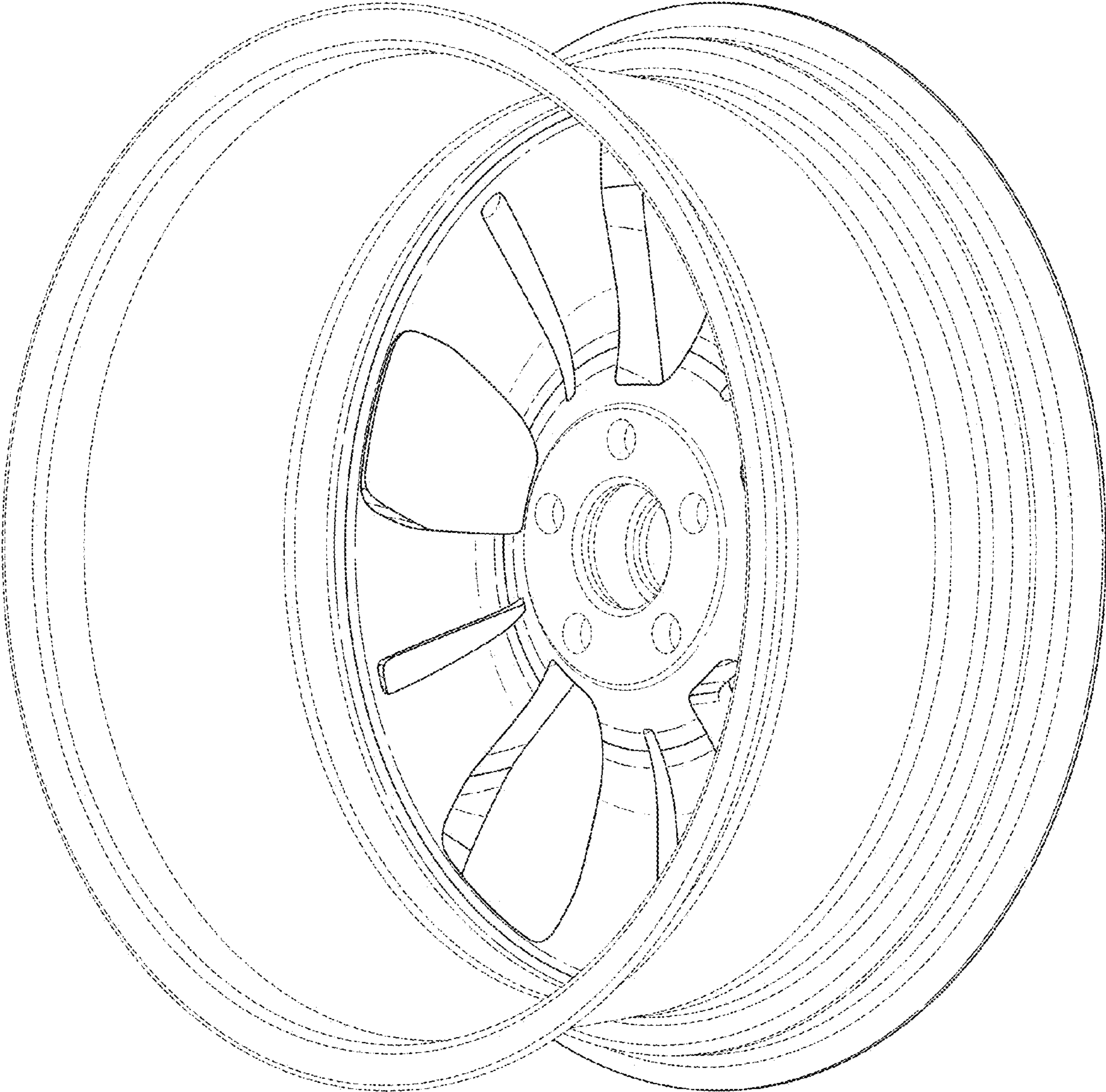

FIG. 2

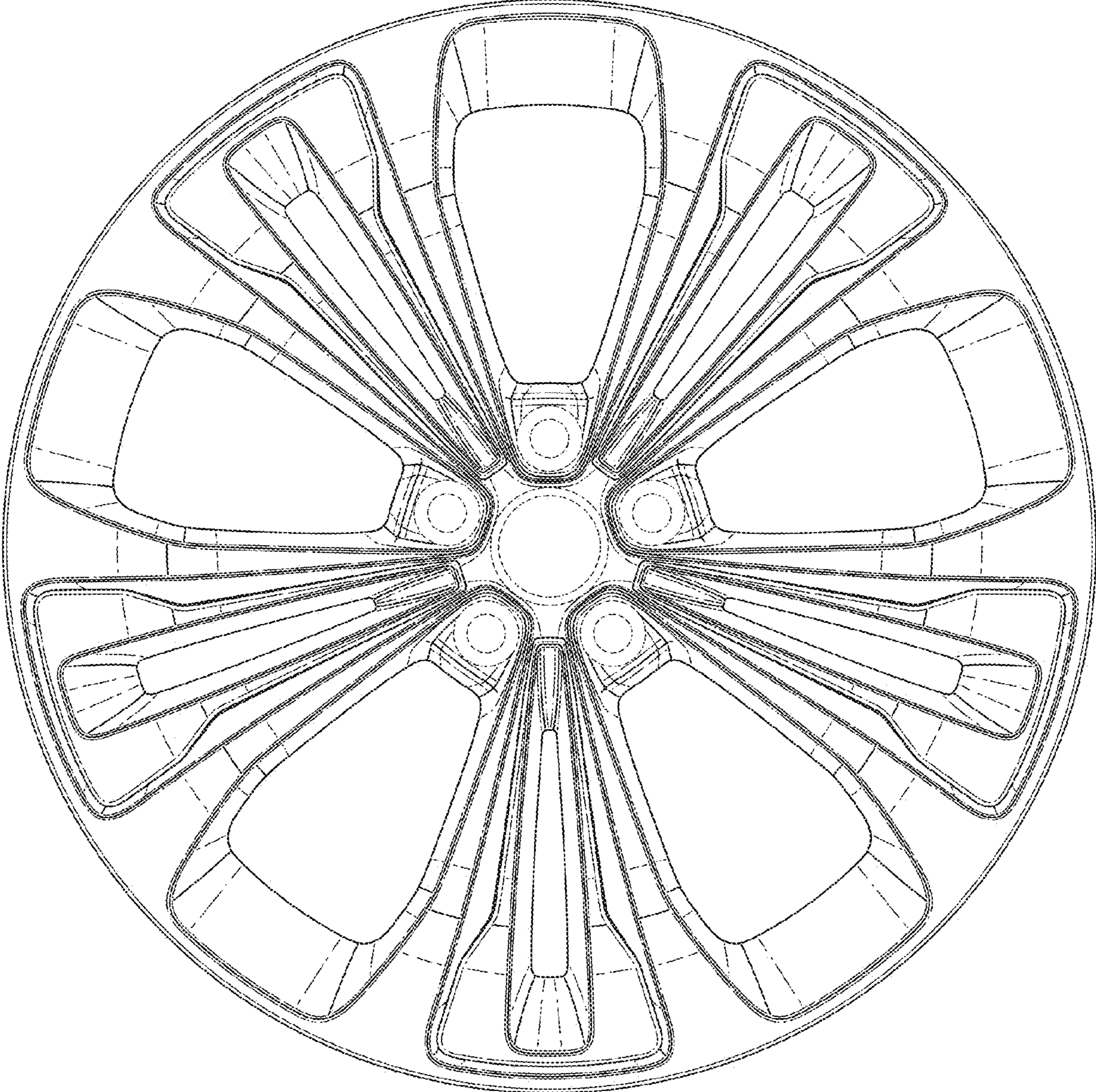

FIG. 3

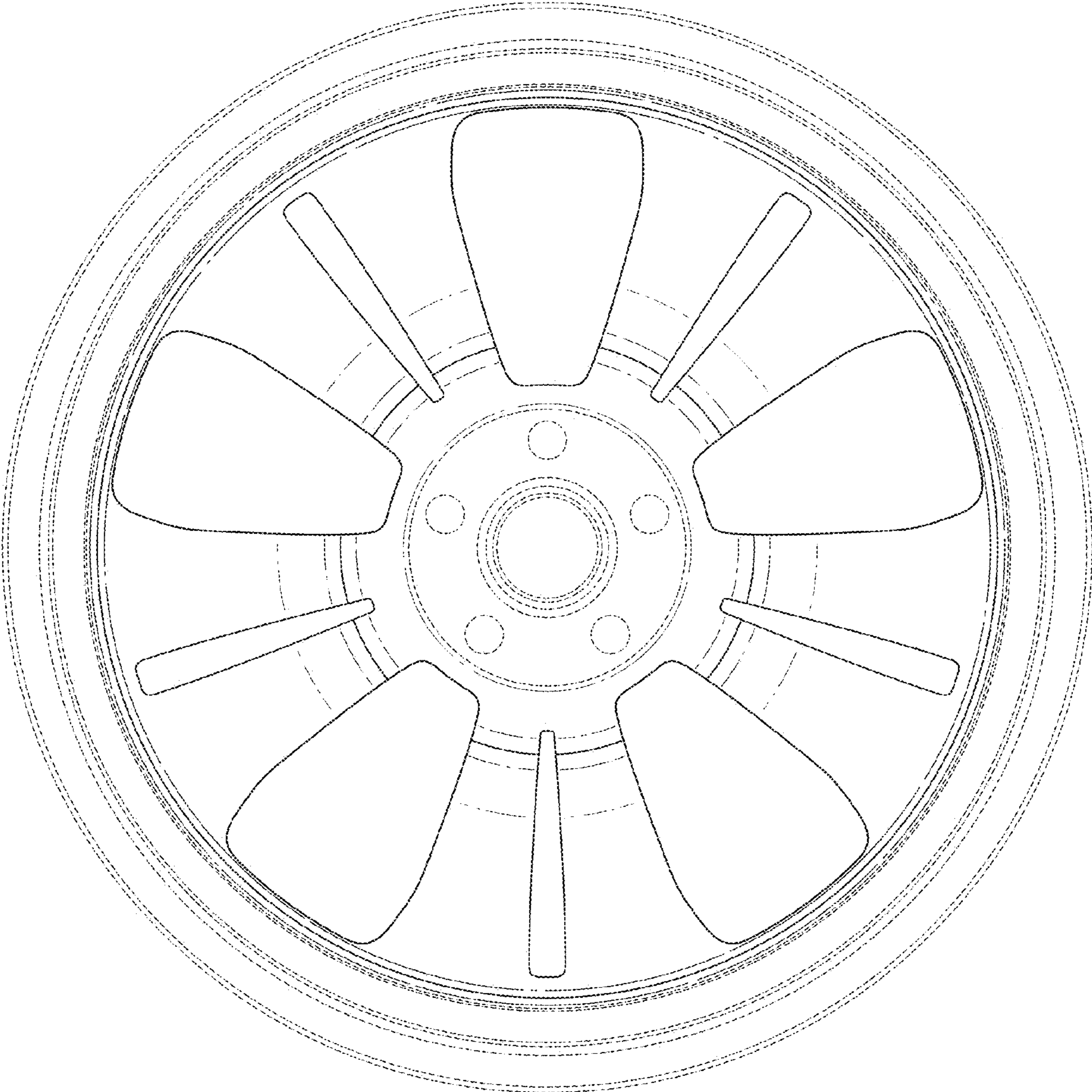

FIG. 4

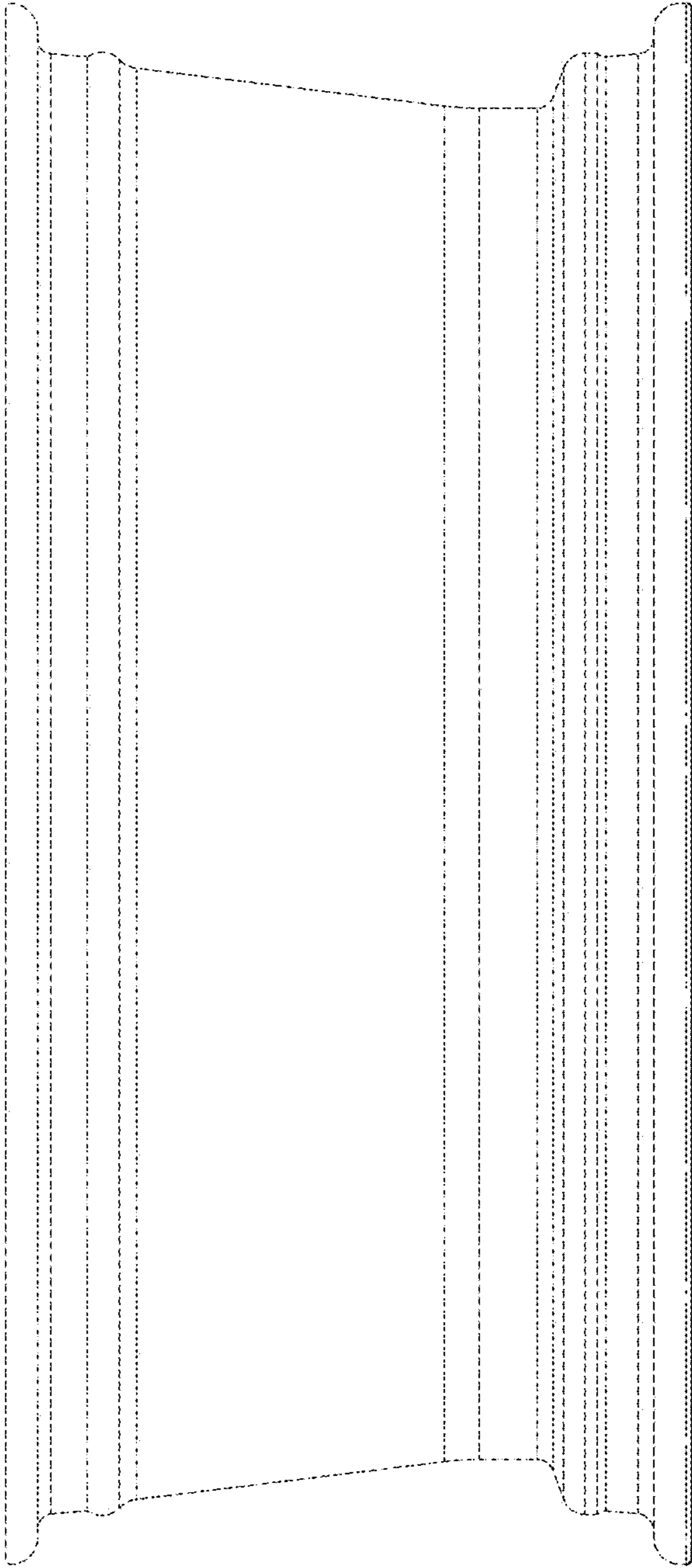

FIG. 5

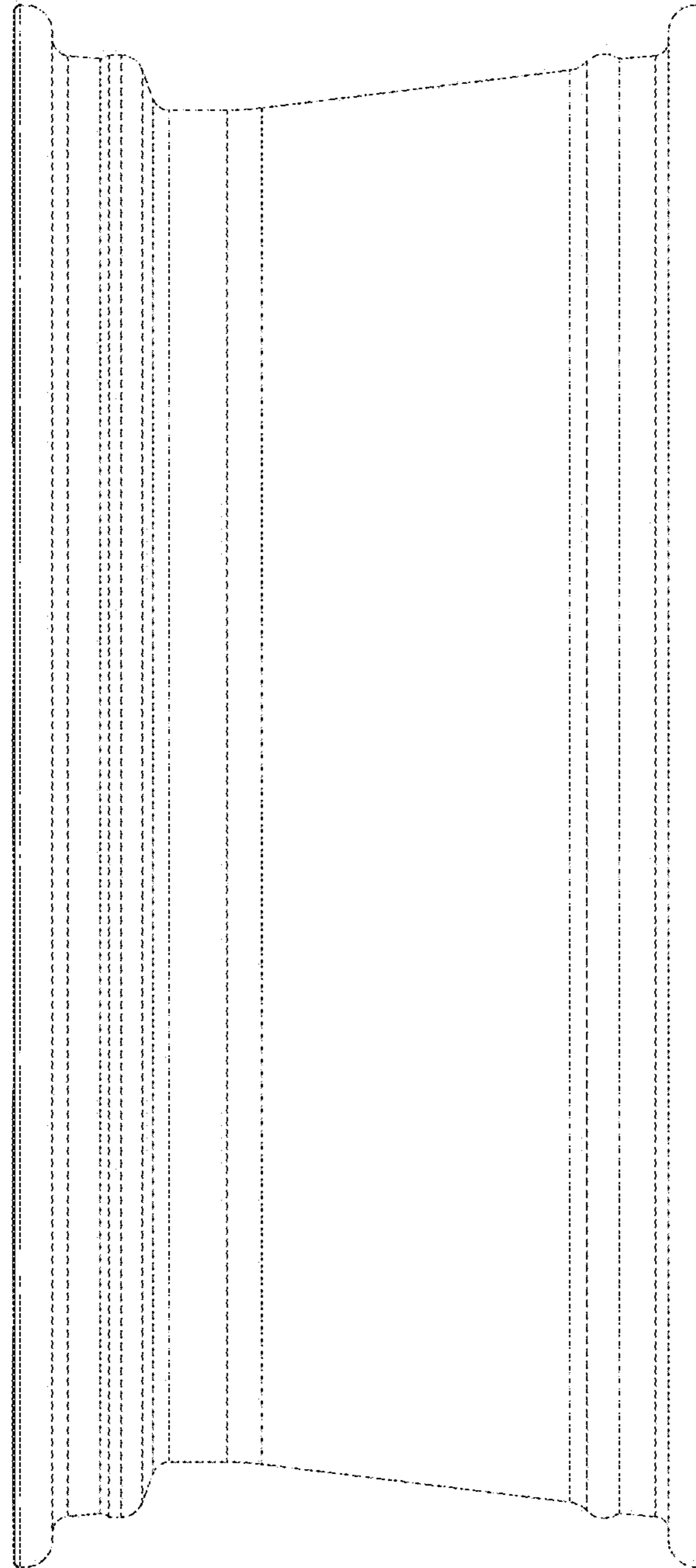

FIG. 6

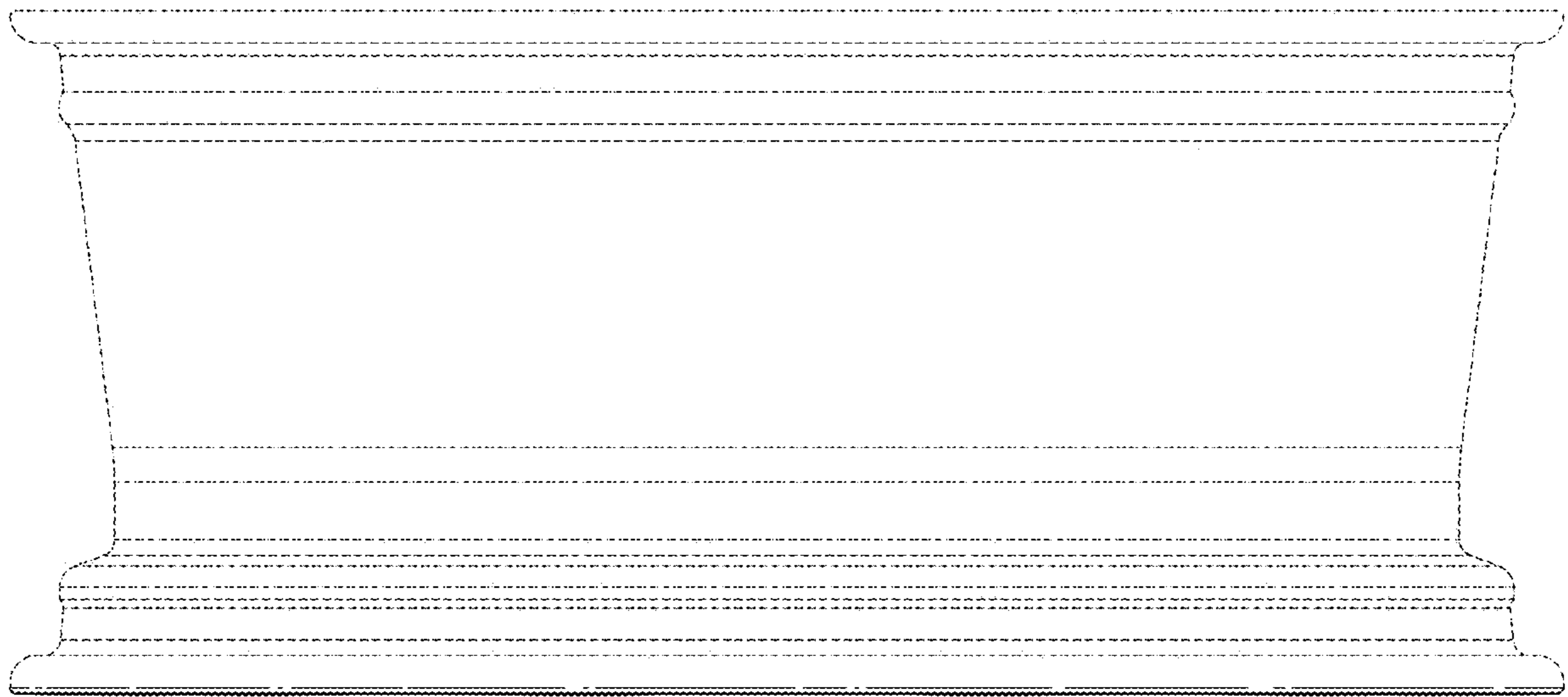

FIG. 7

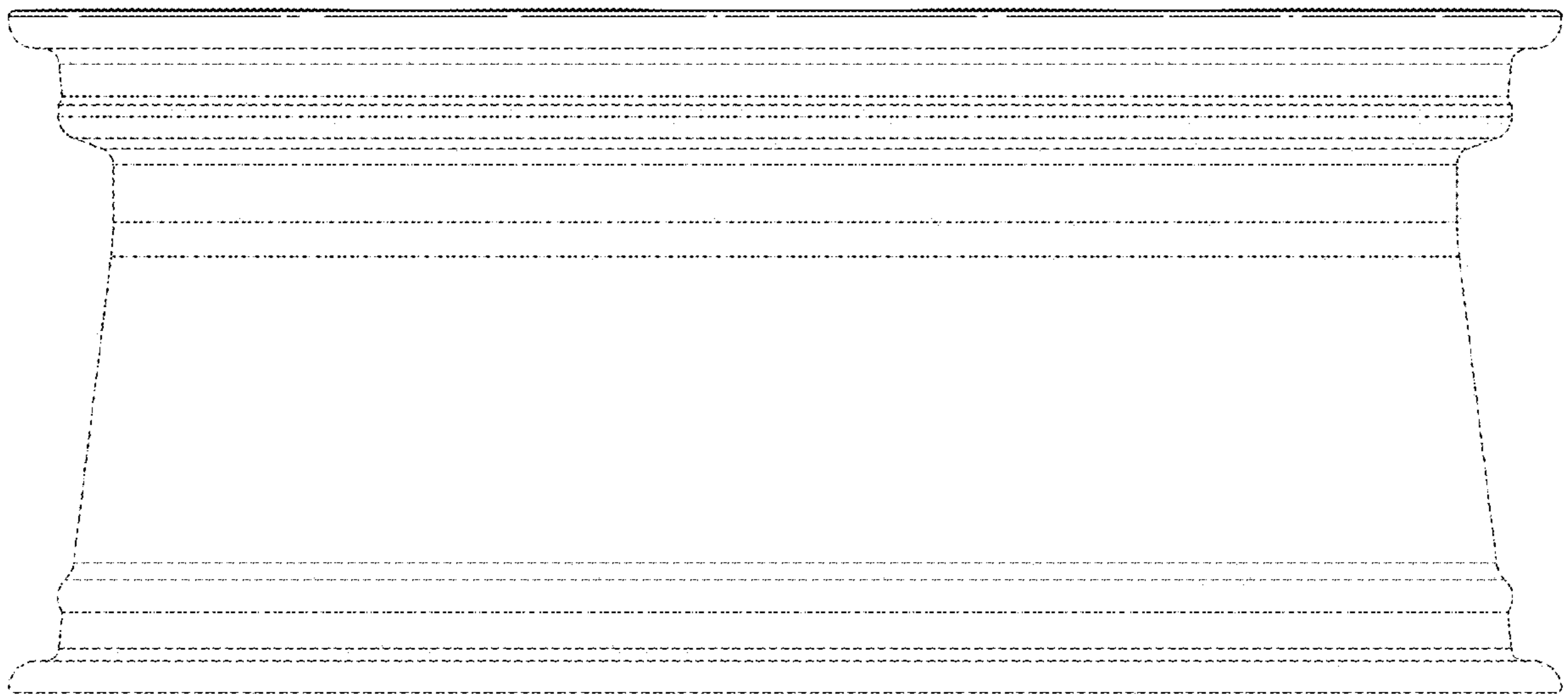

FIG. 8