



US00D933559S

(12) **United States Design Patent** (10) **Patent No.:** **US D933,559 S**
Wraith et al. (45) **Date of Patent:** **** Oct. 19, 2021**

(54) **VEHICLE DOOR**
(71) Applicant: **Ford Global Technologies, LLC**,
Dearborn, MI (US)
(72) Inventors: **Paul Wraith**, West Bloomfield, MI
(US); **Martin Coons**, Detroit, MI (US);
Ryan Olsson, Farmington Hills, MI
(US); **Robert Gelardi**, Plymouth, MI
(US)
(73) Assignee: **Ford Global Technologies, LLC**,
Dearborn, MI (US)

D391,897 S * 3/1998 Murata D12/86
D422,941 S * 4/2000 Sigurosson D12/91
6,212,851 B1 * 4/2001 Visconti B60J 5/0402
296/146.1
D456,312 S * 4/2002 Leutz D12/86
D484,440 S * 12/2003 Okonkwo D12/92
D583,288 S * 12/2008 Leclercq D12/196
D589,845 S * 4/2009 Shamenkov D12/92
D620,415 S * 7/2010 Froehlich D12/196
D772,772 S * 11/2016 Frascella D12/196
D781,194 S * 3/2017 Bae D12/196
D783,483 S * 4/2017 Choi D12/196

(Continued)

(**) Term: **15 Years**

(21) Appl. No.: **29/734,623**

(22) Filed: **May 14, 2020**

(51) **LOC (13) Cl.** **12-16**

(52) **U.S. Cl.**
USPC **D12/196**

(58) **Field of Classification Search**
USPC D12/1, 85, 86, 88, 89, 90, 91, 92, 93,
D12/184, 190, 192, 193, 195, 196, 400,
D12/414; D21/533, 548, 552, 561
CPC . B60J 5/04; B60J 5/0412; B60J 5/0416; B60J
5/0425; B60J 5/0437; B60J 5/0441; B60J
5/0447; B60J 5/0463; B60J 5/0469; B60J
5/0476; B60J 5/0486; B60J 5/0487; B62D
25/02; B62D 35/00; B60N 3/00
See application file for complete search history.

(56) **References Cited**

U.S. PATENT DOCUMENTS

2,793,069 A * 5/1957 Bixler B62D 33/06
49/385
2,807,498 A * 9/1957 Nelson B60J 5/0412
49/502
5,236,534 A * 8/1993 Noguti B29C 66/8322
156/245

OTHER PUBLICATIONS

Ford Bronco Open Doors, Published Nov. 1, 2020 [online], [retrieved
on 2021-06-29]. Retrieved from the Internet: <https://www.gearpatrol.com/cars/a34480310/ford-bronco-donut-doors-production/> (Year:
2020).*

(Continued)

Primary Examiner — Christian P. McLean

Assistant Examiner — Adam C Mager

(74) *Attorney, Agent, or Firm* — Michael Spenner

(57) **CLAIM**

The ornamental design for a vehicle door, as shown and
described.

DESCRIPTION

FIG. 1 is a front elevational view of a vehicle door, showing
our new design;
FIG. 2 is a left side elevational view thereof;
FIG. 3 is a right side elevational view thereof;
FIG. 4 is a top plan view thereof;
FIG. 5 is a bottom plan view thereof;
FIG. 6 is a top, front and right side perspective view thereof;
and,
FIG. 7 is a bottom, front and right side perspective view
thereof.

1 Claim, 7 Drawing Sheets

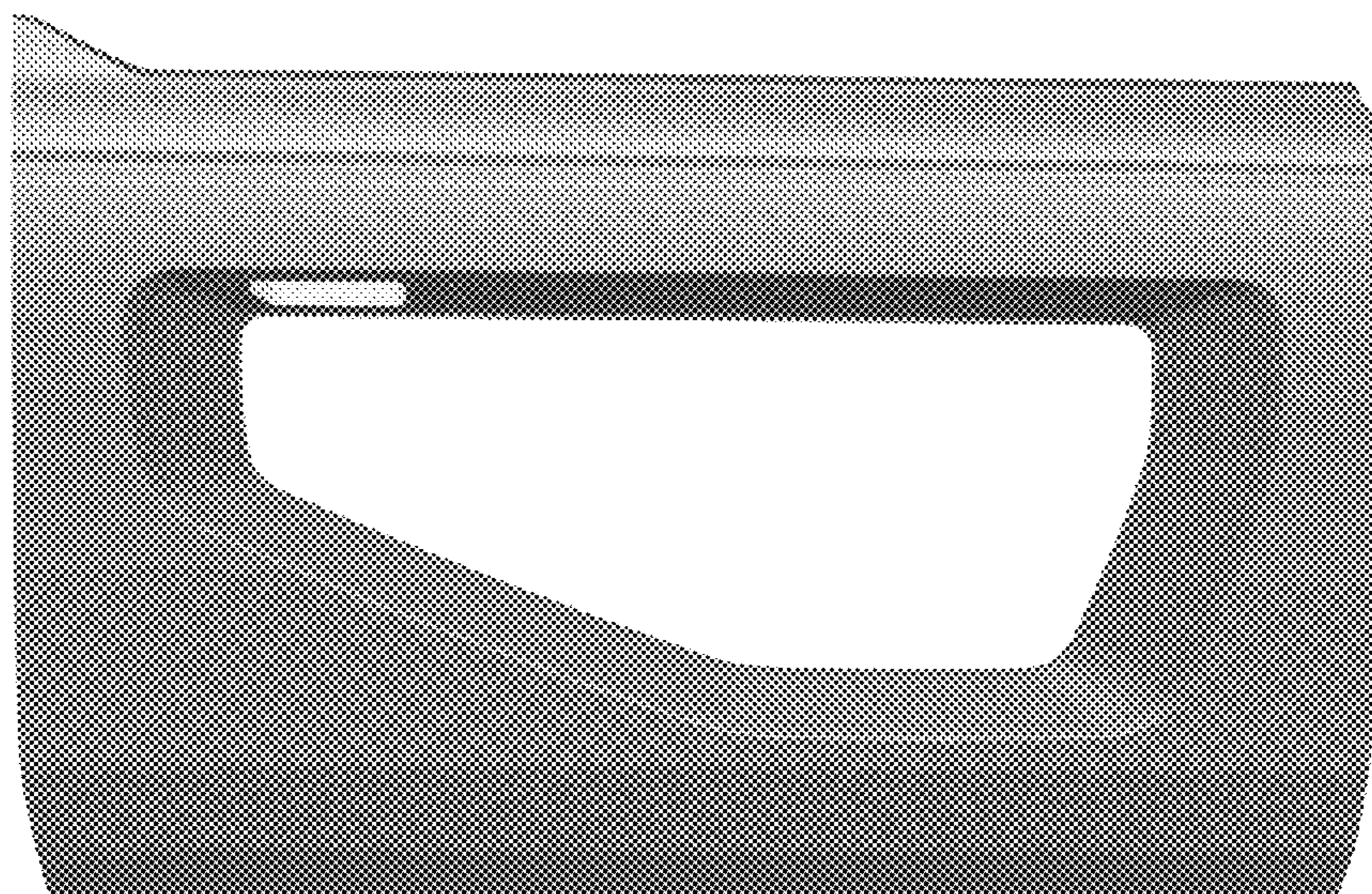

(56)

References Cited

U.S. PATENT DOCUMENTS

D803,121 S * 11/2017 Granlund D12/196
 D804,353 S * 12/2017 Tsuji D12/86
 D810,626 S * 2/2018 Macey D12/91
 D813,775 S * 3/2018 Choi D12/196
 D838,641 S * 1/2019 Ojea D12/196
 D839,164 S * 1/2019 Zipfel D12/196
 D842,183 S * 3/2019 Jackson D12/195
 D844,520 S * 4/2019 Razaghi D12/196
 D846,466 S * 4/2019 Higgs D12/196
 D846,467 S * 4/2019 Higgs D12/196
 D851,004 S * 6/2019 Jackson D12/196
 D853,925 S * 7/2019 Grewer D12/196
 D863,170 S * 10/2019 Zipfel D12/196
 2007/0075565 A1 * 4/2007 Magsaam B66F 9/07536
 296/146.11
 2007/0261313 A1 * 11/2007 Ruppert B60J 5/0406
 49/502
 2016/0311296 A1 * 10/2016 Flores B60R 3/00
 2019/0009655 A1 * 1/2019 Getzschman B60J 5/0476
 2019/0118625 A1 * 4/2019 Tate B60J 5/0472

2019/0232766 A1 * 8/2019 Patel B60J 5/0447
 2019/0256037 A1 * 8/2019 Ghannam B60R 21/21
 2019/0337365 A1 * 11/2019 Marchetti B60J 5/0486
 2020/0180407 A1 * 6/2020 Whipps B60N 3/02
 2020/0207190 A1 * 7/2020 Getzschman B60J 1/10
 2021/0162842 A1 * 6/2021 Dahlgren B60J 5/0481

OTHER PUBLICATIONS

Unknown, My observations from seeing see the actual 4-door Bronco raw, unpainted sheet metal shell, Feb. 15, 2020 <https://https://www.bronco6g.com/forum/threads/my-observations-from-seeing-see-the-actual-4-door-bronco-raw-unpainted-sheet-metal-shell.1048/>.

Unknown, Here's the 2021 Bronco's Tail Light Shape Illuminated, Feb. 19, 2020 <https://www.bronco6g.com/forum/threads/heres-the-2021-broncos-tail-light-shape-illuminated.1071/>.

Unknown, 2021 Bronco Interior Spied Undisguised!!, Feb. 25, 2020 <https://www.bronco6g.com/forum/threads/2021-bronco-interior-spied-undisguised.1096/>.

* cited by examiner

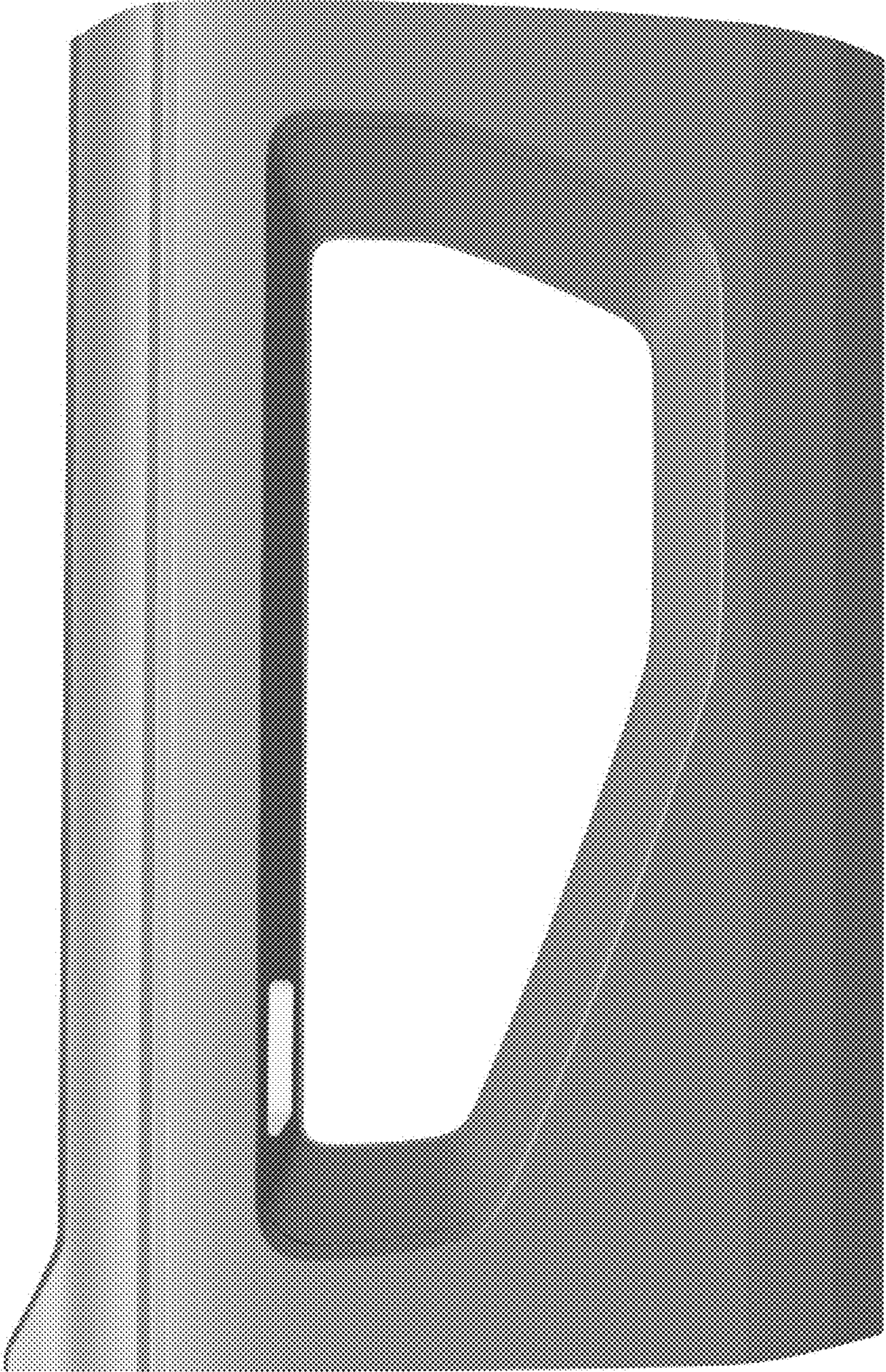

Fig.1

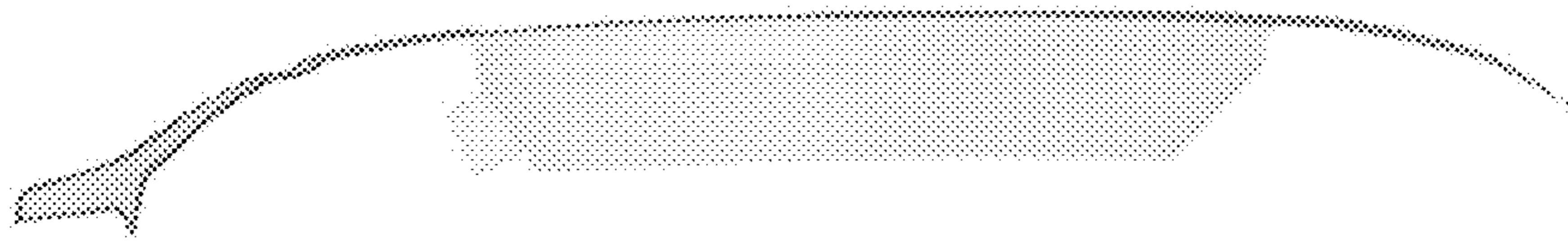

Fig. 2

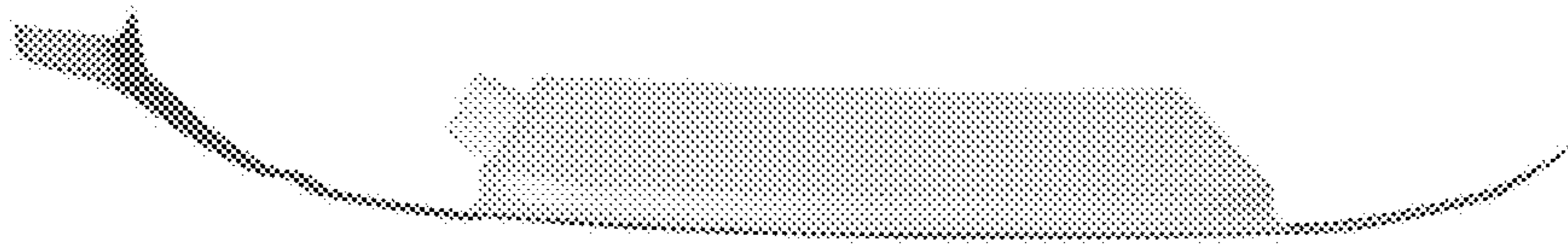

Fig. 3

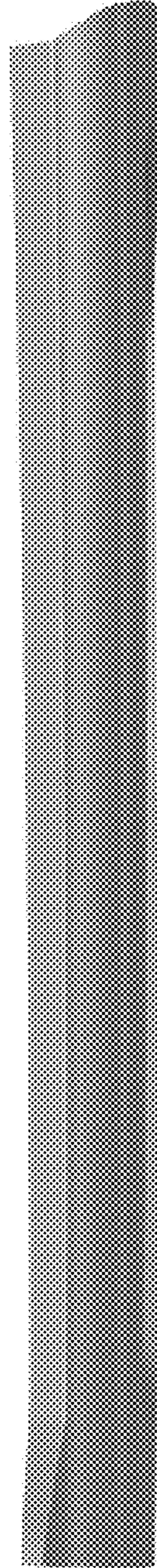

Fig.4

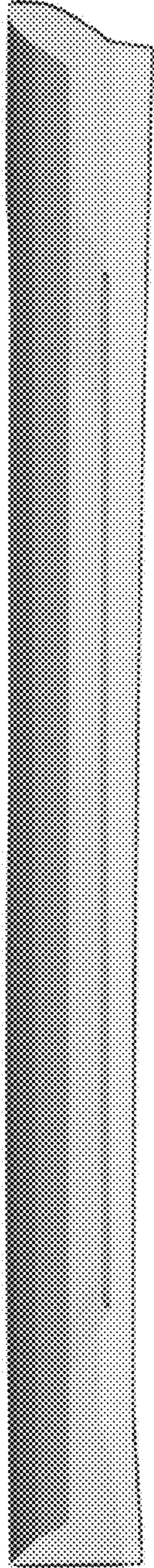

Fig. 5

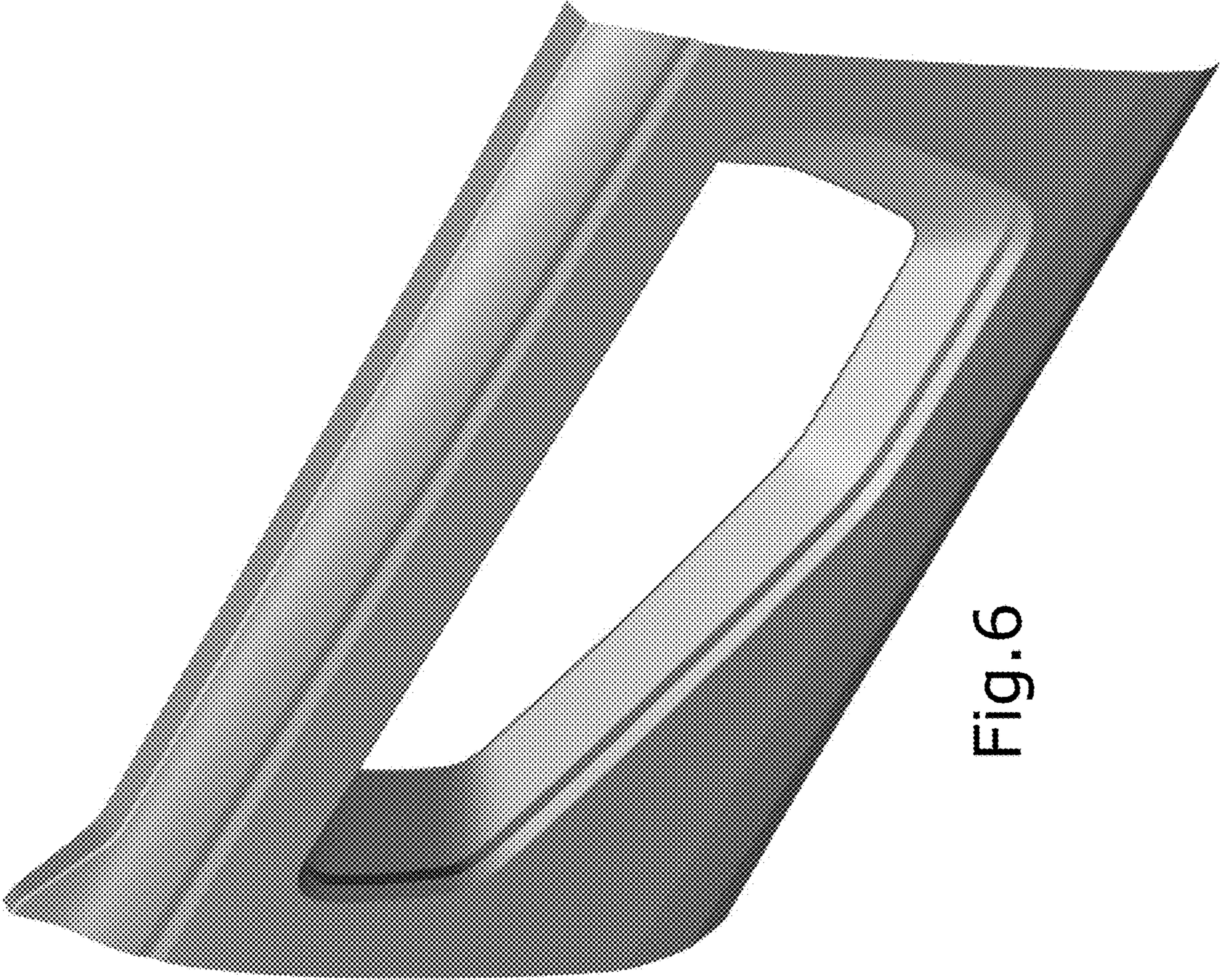

Fig.6



Fig. 7