



US00D933295S

(12) **United States Design Patent** (10) **Patent No.:** **US D933,295 S**
Washington et al. (45) **Date of Patent:** **** *Oct. 12, 2021**

- (54) **SHAVING RAZOR CARTRIDGE**
- (71) Applicant: **The Gillette Company LLC**, Boston, MA (US)
- (72) Inventors: **Jack Anthony Washington**, Mendon, MA (US); **Neil Dustin Lettenberger**, Boston, MA (US); **Nuala Desai**, Reading (GB); **Daniel Dunham**, Reading (GB); **Mark Peterson**, Reading (GB)
- (73) Assignee: **The Gillette Company LLC**, Boston, MA (US)
- (*) Notice: This patent is subject to a terminal disclaimer.
- (**) Term: **15 Years**
- (21) Appl. No.: **29/698,168**
- (22) Filed: **Jul. 15, 2019**
- (51) **LOC (13) Cl.** **28-03**
- (52) **U.S. Cl.**
USPC **D28/47**
- (58) **Field of Classification Search**
USPC D28/46-47
CPC B26B 21/40; B26B 21/4018; B26B 21/443
See application file for complete search history.

- D662,661 S * 6/2012 Corbeil D28/47
- 8,209,869 B2 7/2012 Royle
- 8,413,334 B2 4/2013 Walker, Jr.
- 8,438,736 B2 5/2013 Keene
- D699,892 S 2/2014 Wonderley
- D701,646 S 3/2014 Jobdevairakkam
- D707,885 S * 6/2014 Cataudella D28/47
- 8,931,176 B2 1/2015 Johnson
- D748,856 S * 2/2016 Mahony D28/47
- D749,265 S * 2/2016 Cataudella D28/47
- 9,296,117 B2 3/2016 Fathallah
- D764,101 S * 8/2016 Cataudella D28/47
- D811,658 S * 2/2018 Cataudella D28/47
- D843,059 S * 3/2019 Lettenberger D28/47
- D844,898 S * 4/2019 Knapp D28/47
- D850,722 S * 6/2019 Knapp D28/47

(Continued)

OTHER PUBLICATIONS

All Office Actions; U.S. Appl. No. 16/863,251.

Primary Examiner — Jennifer Rivard

(74) *Attorney, Agent, or Firm* — John M. Lipchitz

(57) **CLAIM**

The ornamental design for a shaving razor cartridge, as shown and described.

DESCRIPTION

FIG. 1 is a first perspective view of a design for a shaving razor cartridge of the present invention;
 FIG. 2 is a top view thereof;
 FIG. 3 is a bottom view thereof;
 FIG. 4 is a right side view thereof;
 FIG. 5 is a left side view thereof;
 FIG. 6 is a rear view thereof;
 FIG. 7 is a front view thereof; and,
 FIG. 8 is a second front perspective view thereof.
 The dash broken lines are directed to portions of the shaving razor cartridge and form no part of the claimed design.

1 Claim, 5 Drawing Sheets

(56) **References Cited**

U.S. PATENT DOCUMENTS

| | | | | |
|-----------|-----|---------|---------|--------------|
| 5,475,923 | A | 12/1995 | Ferraro | |
| 5,689,883 | A | 11/1997 | Ortiz | |
| 5,953,819 | A | 9/1999 | Simms | |
| D563,043 | S * | 2/2008 | Ramm | D28/47 |
| D604,904 | S | 11/2009 | Watson | |
| D627,100 | S * | 11/2010 | Kinard | D28/47 |
| D627,101 | S * | 11/2010 | Kinard | D28/47 |
| D634,474 | S * | 3/2011 | Wilby | D28/47 |

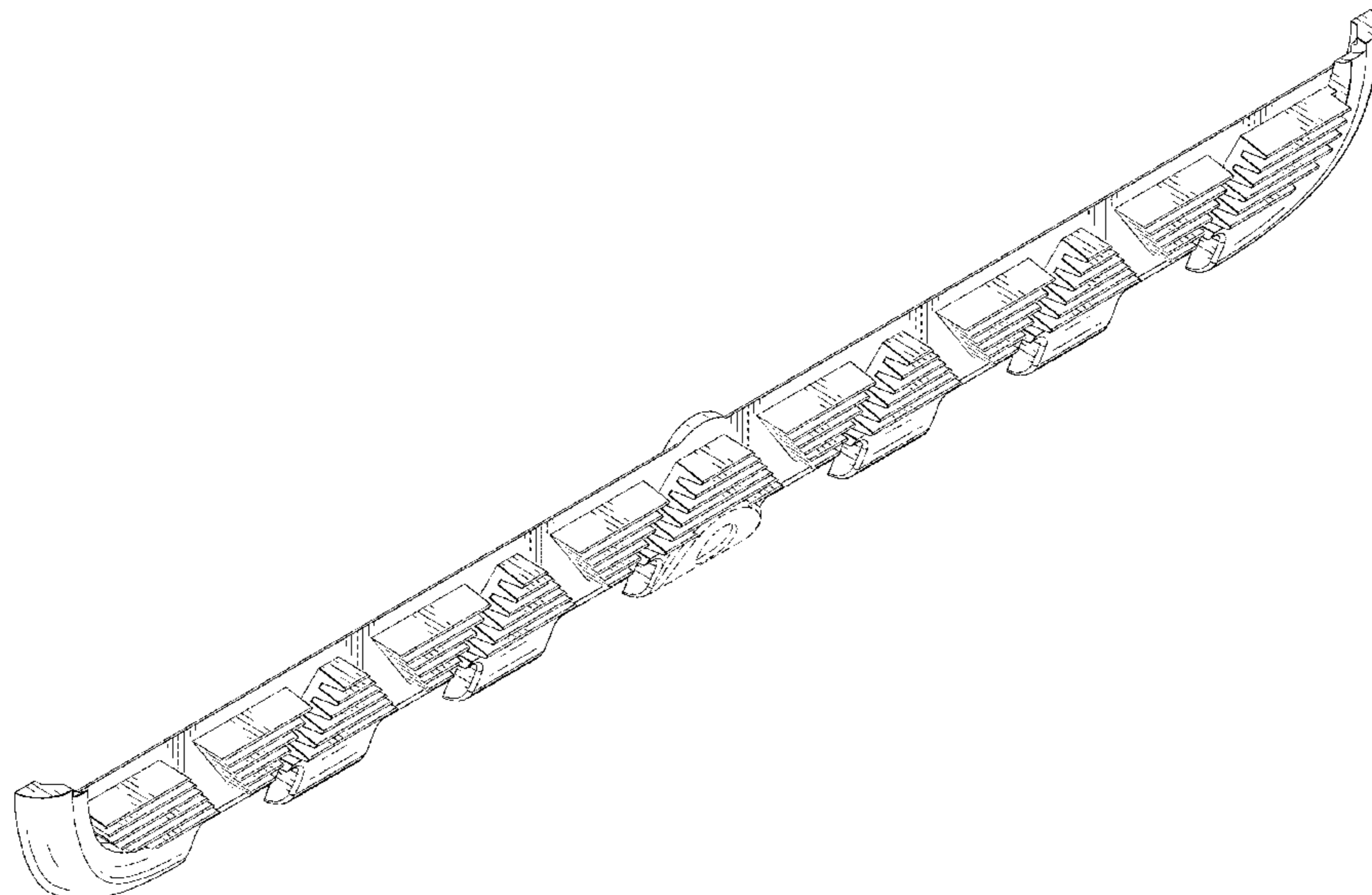

(56)

References Cited

U.S. PATENT DOCUMENTS

| | | | | | | | | | |
|-----------------|---------|---------------|-------|-------------|------------------|---------|-----------------|-------|--------------|
| D866,858 S * | 11/2019 | Long | | D28/47 | 2014/0366381 A1* | 12/2014 | Phipps | | A61K 8/86 |
| D872,937 S * | 1/2020 | Kottidi | | D28/47 | | | | | 30/41 |
| D882,873 S * | 4/2020 | Goeder | | D28/46 | 2015/0013169 A1* | 1/2015 | Warrick | | B26B 21/4031 |
| D883,570 S * | 5/2020 | Liberatore | | B26B 21/522 | | | | | 30/50 |
| | | | | D28/47 | 2015/0040402 A1* | 2/2015 | Carneiro | | B26B 21/443 |
| D884,969 S * | 5/2020 | Zucker | | D28/47 | | | | | 30/41 |
| D884,970 S * | 5/2020 | Zucker | | D28/47 | 2015/0090085 A1* | 4/2015 | Griffin | | B26B 21/4012 |
| D884,971 S * | 5/2020 | Zucker | | D28/47 | | | | | 83/13 |
| D892,406 S * | 8/2020 | Ren | | D28/47 | 2016/0129603 A1* | 5/2016 | Antoniou | | B26B 21/44 |
| D895,208 S * | 9/2020 | Jin | | D28/47 | | | | | 30/50 |
| D897,040 S * | 9/2020 | Kong | | D28/47 | 2016/0158948 A1* | 6/2016 | Eagleton | | B26B 21/443 |
| D897,041 S * | 9/2020 | Ahn | | D28/47 | | | | | 30/34.2 |
| D905,340 S * | 12/2020 | Fischer | | D28/47 | 2016/0236364 A1* | 8/2016 | Varenberg | | B26B 21/443 |
| D908,285 S * | 1/2021 | Cataudella | | D28/47 | 2016/0279817 A1* | 9/2016 | Washington | | B26B 21/227 |
| D912,324 S * | 3/2021 | Han | | D28/47 | 2017/0021513 A1* | 1/2017 | Liberatore | | B26B 21/521 |
| D912,325 S * | 3/2021 | Go | | D28/47 | 2017/0151684 A1* | 6/2017 | Bozikis | | B26B 21/4068 |
| D913,591 S * | 3/2021 | Ramm | | D28/47 | 2017/0282388 A1 | 10/2017 | Haines | | |
| 2009/0223057 A1 | 9/2009 | Coope-epstein | | | 2017/0282389 A1* | 10/2017 | Jolley | | B26B 21/4018 |
| | | | | | 2018/0071931 A1* | 3/2018 | Walker, Jr. | | B26B 21/4006 |
| | | | | | 2018/0236677 A1* | 8/2018 | Blatter | | B26B 21/44 |
| | | | | | 2021/0016458 A1 | 1/2021 | Peterson et al. | | |

* cited by examiner

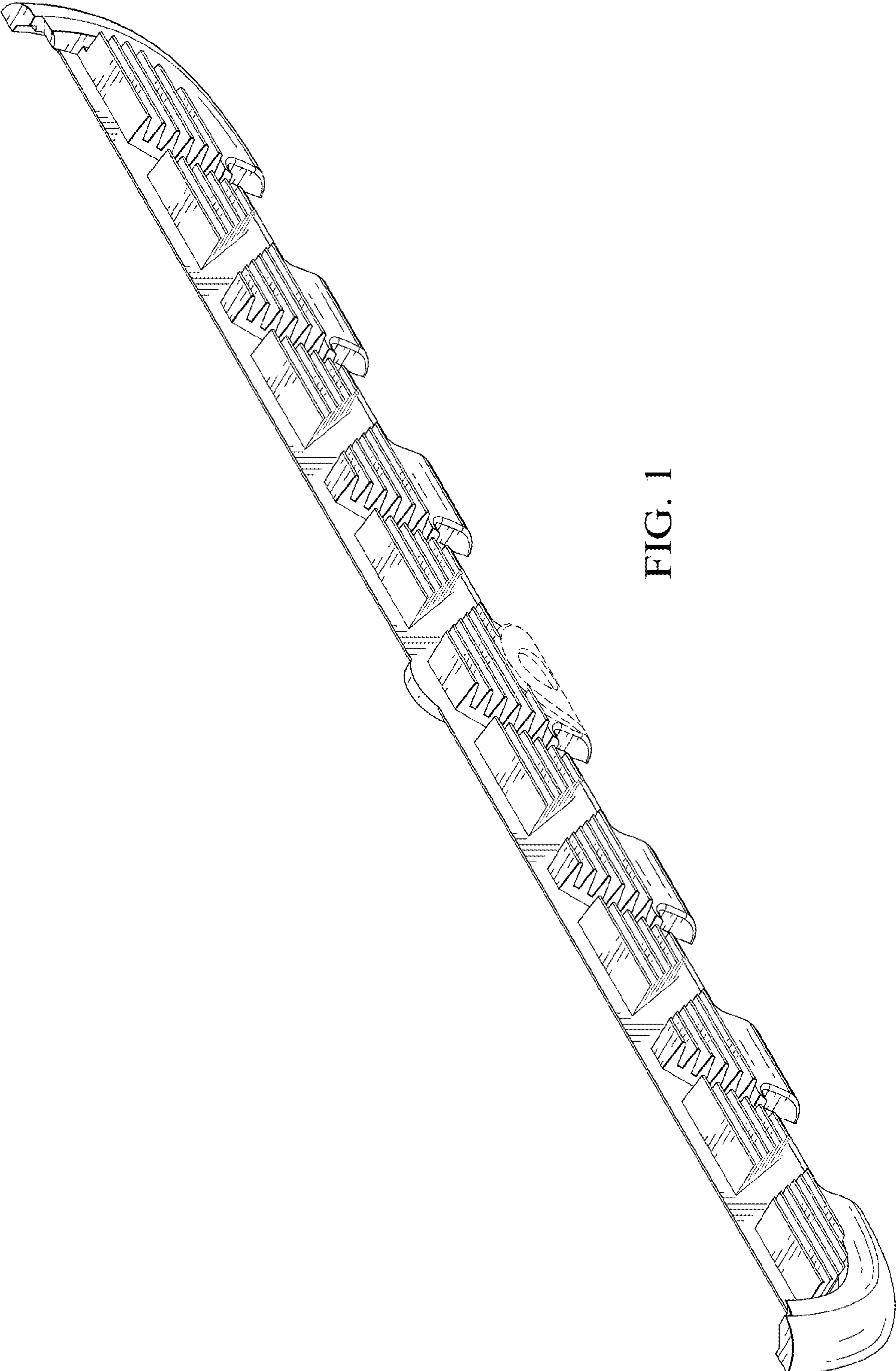

FIG. 1

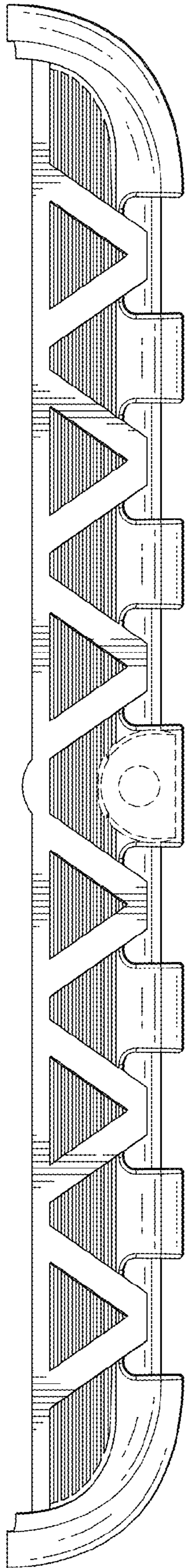

FIG. 2

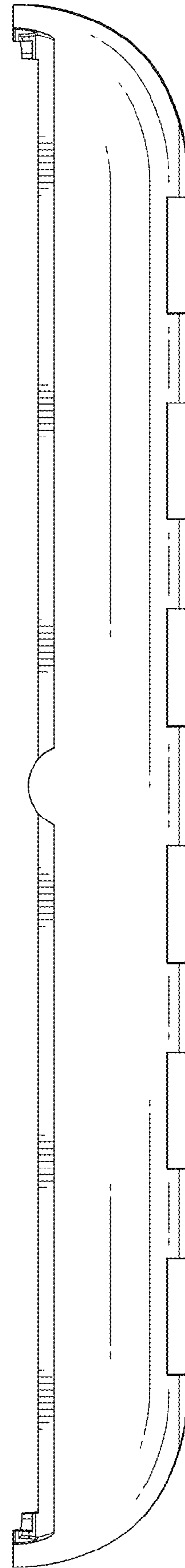

FIG. 3



FIG. 5



FIG. 4

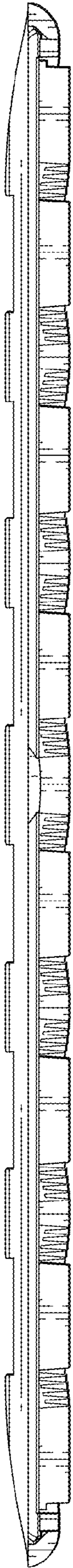

FIG. 6

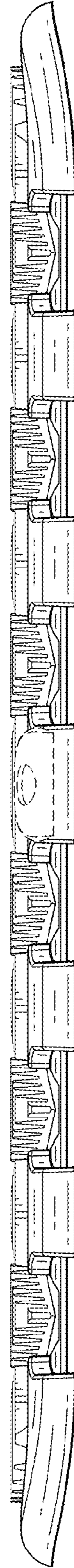

FIG. 7

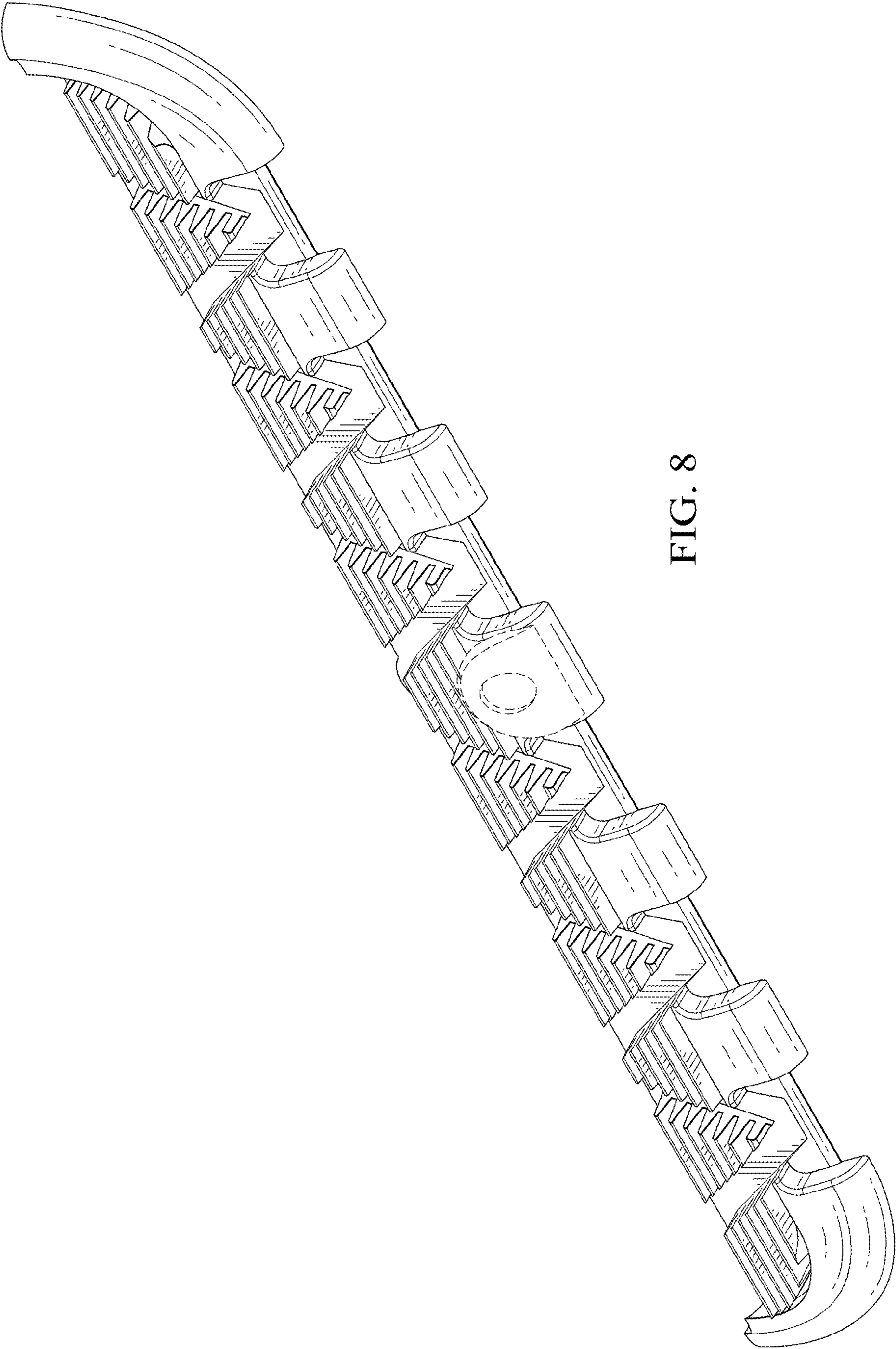

FIG. 8