



US00D933252S

(12) **United States Design Patent** (10) **Patent No.:** **US D933,252 S**
Cheung (45) **Date of Patent:** **** Oct. 12, 2021**

- (54) **VIBRATOR**
- (71) Applicant: **Brandcore Limited**, Tortola (VG)
- (72) Inventor: **Lai Lam Cheung**, Ma On Shan (HK)
- (73) Assignee: **Brandcore Limited**
- (**) Term: **15 Years**
- (21) Appl. No.: **29/606,047**
- (22) Filed: **Jun. 1, 2017**
- (30) **Foreign Application Priority Data**
Dec. 2, 2016 (EM) 003496785
- (51) **LOC (13) Cl.** **28-03**
- (52) **U.S. Cl.**
USPC **D24/215**
- (58) **Field of Classification Search**
USPC D3/12; D15/147; D24/200, 201-215
CPC A61H 19/34; A61H 19/44; A61H 19/50;
A61H 2201/1692; A61H 2201/0153
See application file for complete search history.

(56) **References Cited**

U.S. PATENT DOCUMENTS

D653,349 S *	1/2012	Chong	D24/215
D670,398 S *	11/2012	Peddicord	D24/215
D670,399 S *	11/2012	Peddicord	D24/215
D681,219 S *	4/2013	Chen	D24/215
D681,223 S *	4/2013	Chen	D24/215
D702,363 S *	4/2014	Tai	D24/215
D705,942 S *	5/2014	Hahr	D24/215
D706,440 S *	6/2014	Hahr	D24/215
D712,054 S *	8/2014	Tai	A61H 19/40
				D24/215
D739,547 S *	9/2015	Cheung	D24/215
D739,548 S *	9/2015	Cheung	D24/215
D743,570 S *	11/2015	Cheung	D24/215

D754,395 S *	4/2016	Yeo	D28/7
D758,604 S *	6/2016	Brinberg	D24/215
D771,828 S *	11/2016	Sedic	D24/215
D771,830 S *	11/2016	Sedic	D24/215
D796,054 S *	8/2017	Chen	D24/215
D796,055 S *	8/2017	Chen	D24/215
9,730,857 B1 *	8/2017	Loya	A61H 19/50
D798,465 S *	9/2017	Lin	D24/215
D818,142 S *	5/2018	Cheung	D24/215
D818,143 S *	5/2018	Cheung	D24/215
D818,144 S *	5/2018	Cheung	D24/215
D818,603 S *	5/2018	Marshall	D24/215
D827,850 S *	9/2018	Pounders	D24/215
2013/0178769 A1 *	7/2013	Schmidt	A61H 19/34
				601/46
2016/0120737 A1 *	5/2016	Sedic	A61H 19/34
				601/46
2018/0042809 A1 *	2/2018	Zipper	A61N 5/0622

* cited by examiner

Primary Examiner — Michael C Stout

Assistant Examiner — Fritzgerald L Butac

(74) *Attorney, Agent, or Firm* — Merek, Blackmon & Voorhees, LLC

(57) **CLAIM**

The ornamental design for a vibrator, as shown and described.

DESCRIPTION

FIG. 1 is a bottom view of the vibrator with the ornamental design.

FIG. 2 is a front elevation view of the vibrator in FIG. 1.

FIG. 3 is a left side view of the vibrator of FIG. 1;

FIG. 4 is a back elevation view of the vibrator in FIG. 1.

FIG. 5 is a top view of the vibrator of FIG. 1; and

FIG. 6 is a perspective view of the vibrator of FIG. 1; and,

FIG. 7 is a right side view of the vibrator of FIG. 1.

The dashed broken line(s) define the bounds of the claimed design and form no part thereof.

1 Claim, 7 Drawing Sheets

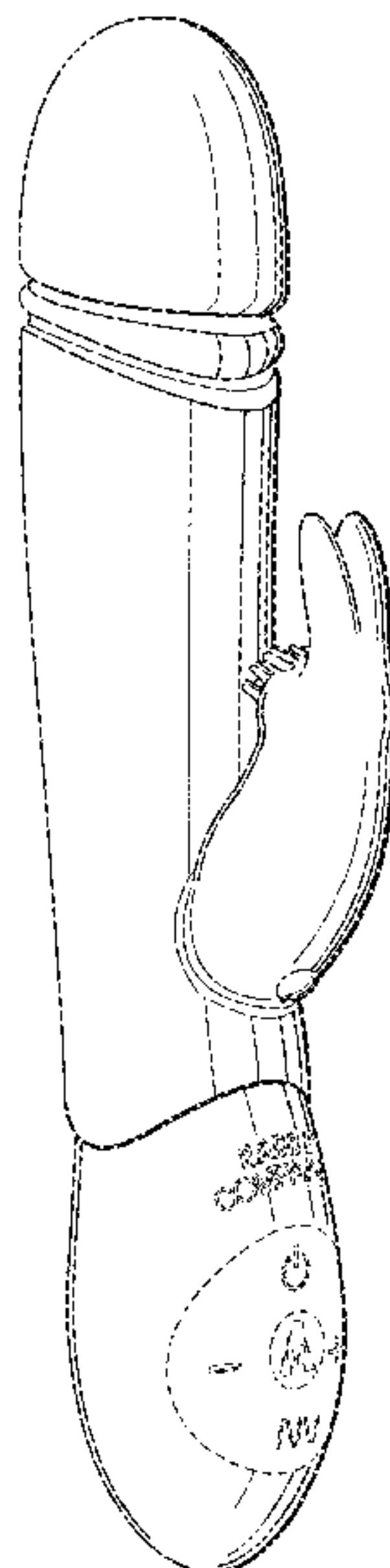

Fig. 1

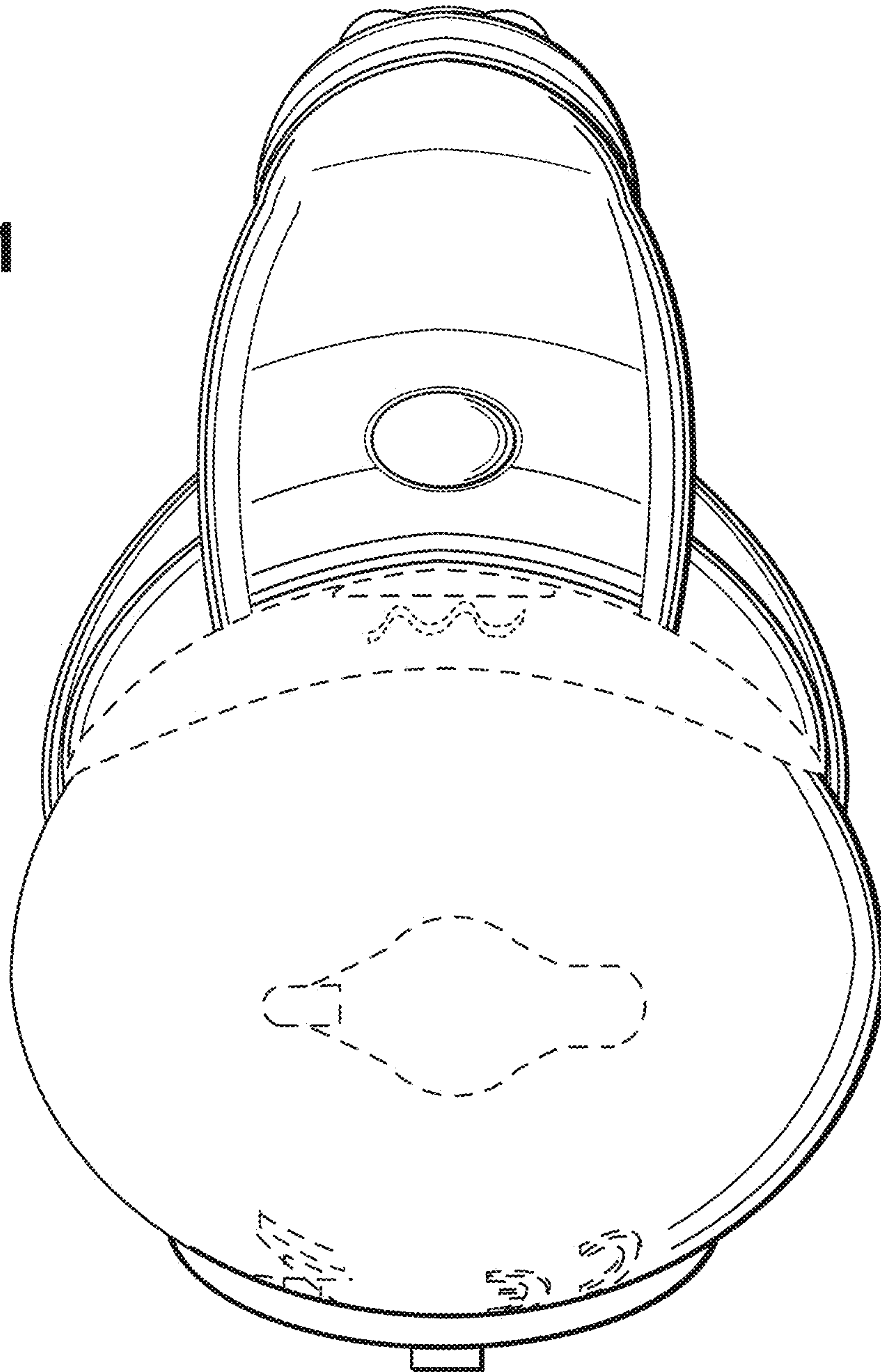

Fig. 2

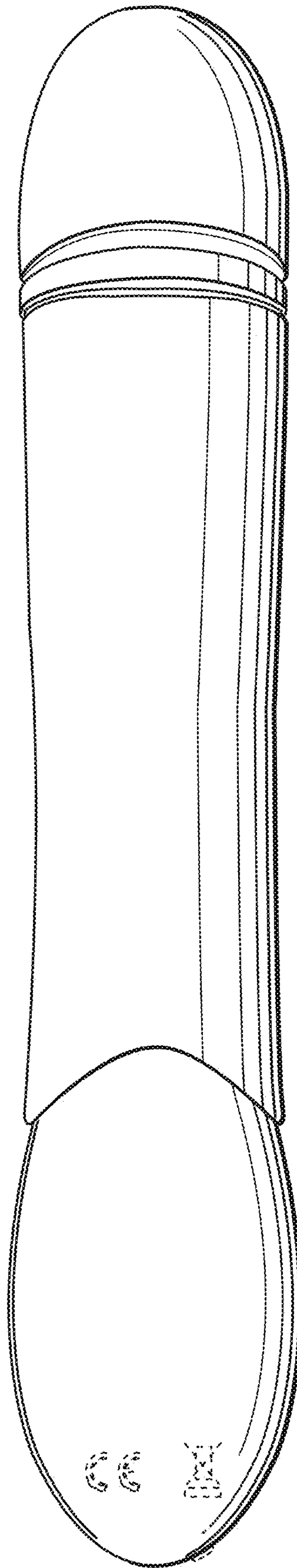

Fig. 3

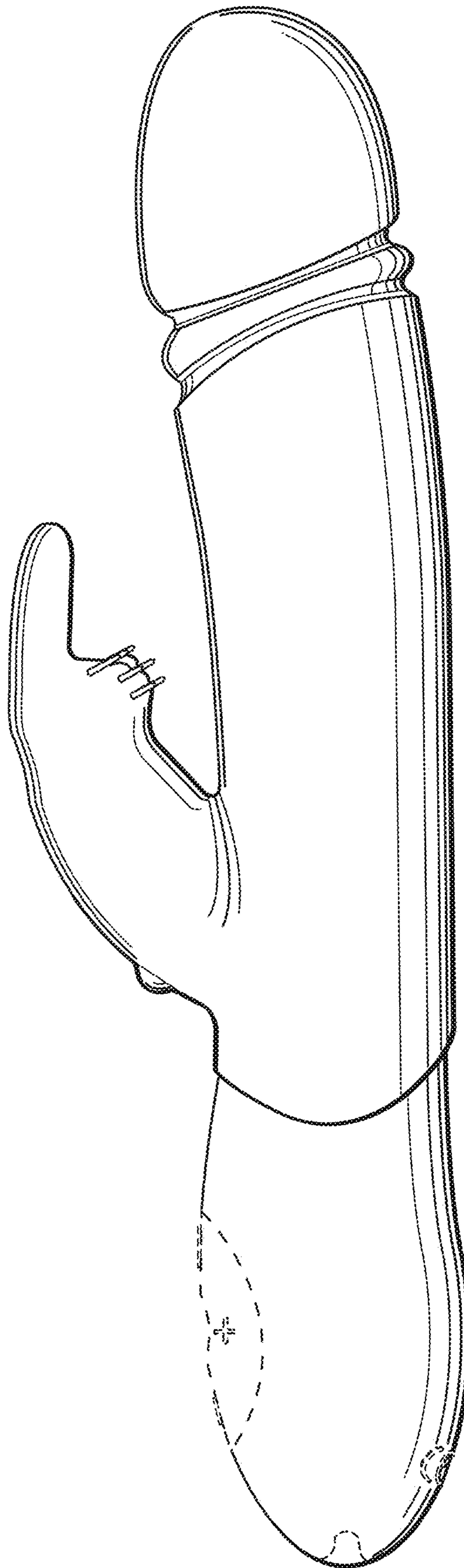
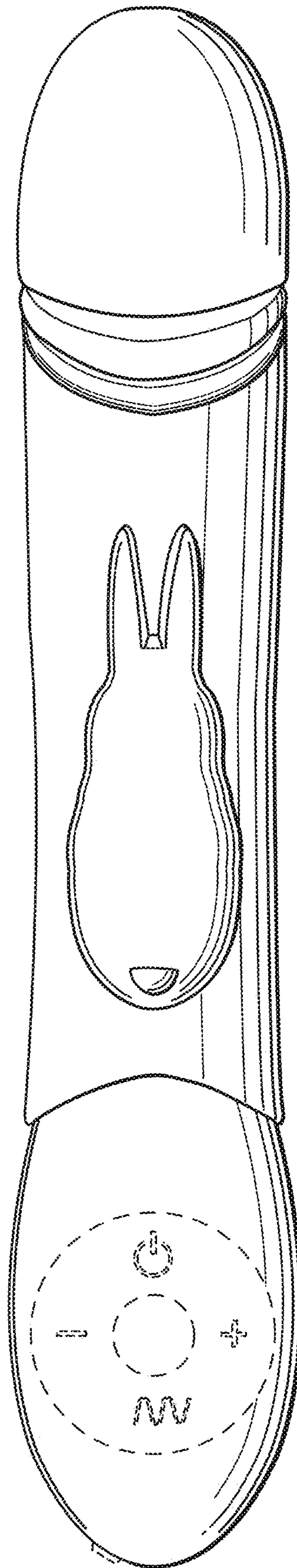

Fig. 4



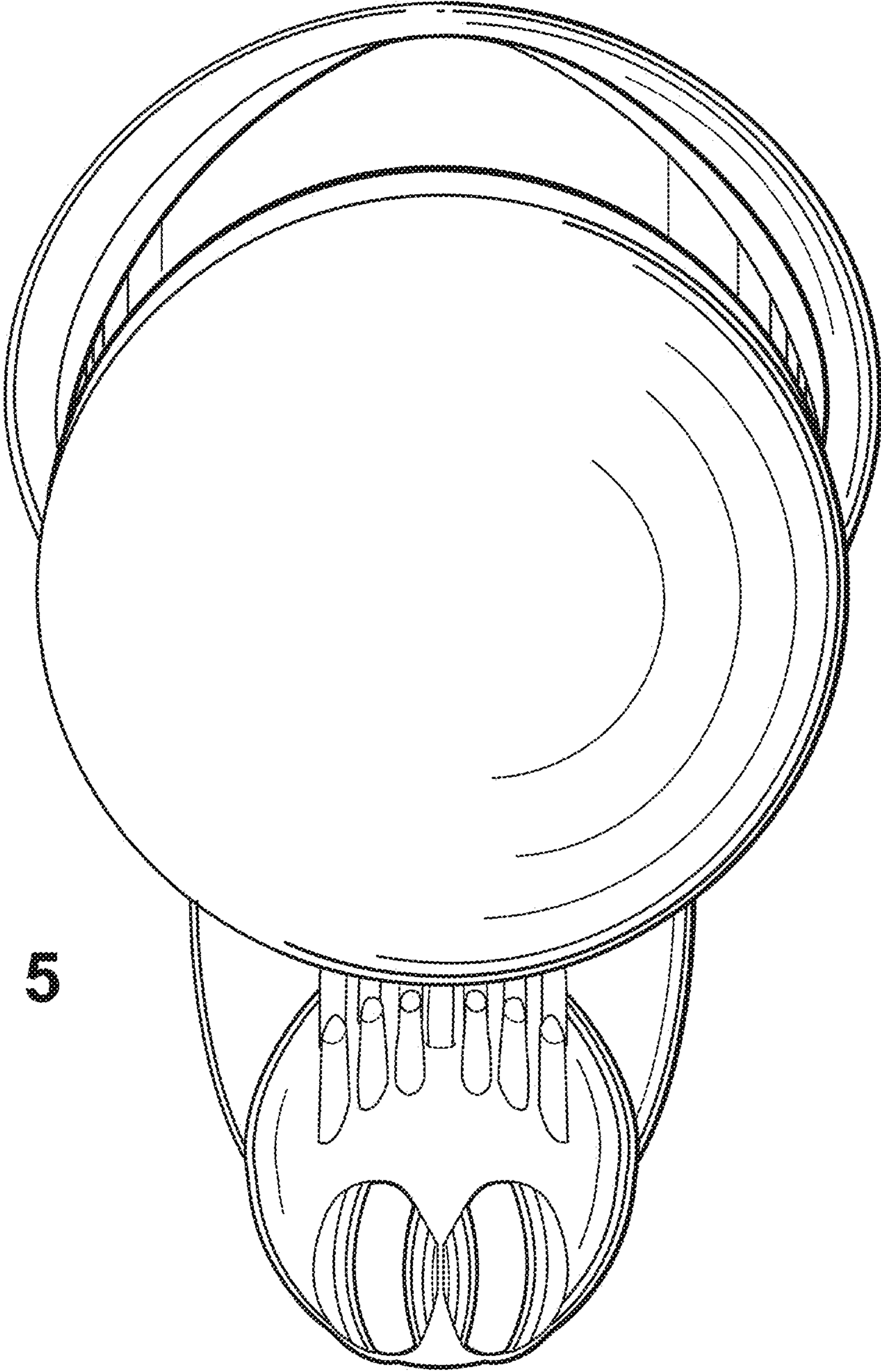

Fig. 5

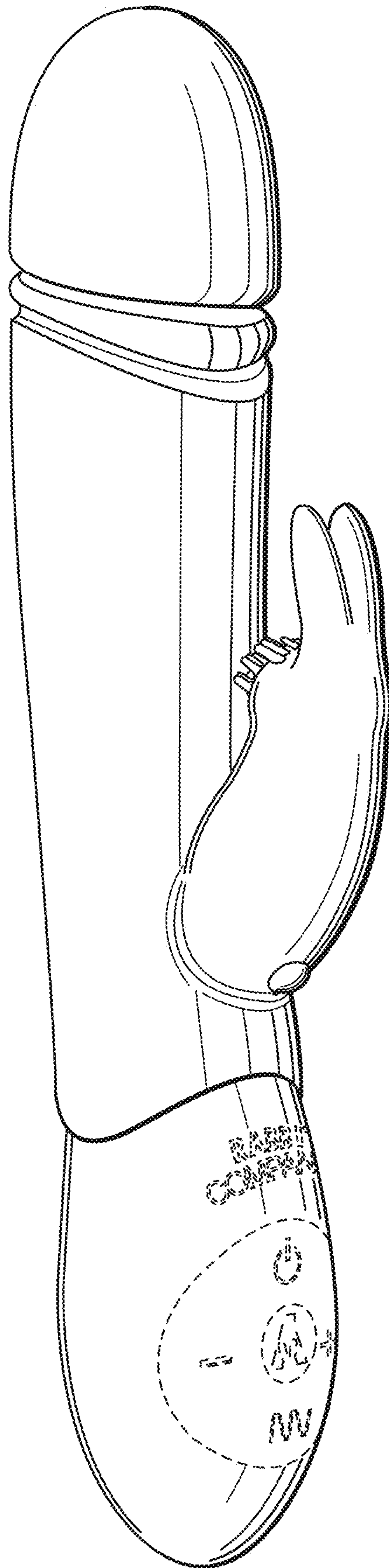

Fig. 6

Fig. 7

