



US00D933212S

(12) **United States Design Patent** (10) **Patent No.:** **US D933,212 S**  
**Sweitzer et al.** (45) **Date of Patent:** **\*\* Oct. 12, 2021**

(54) **SURGICAL PUNCH**

(71) Applicant: **Shukla Medical**, St. Petersburg, FL (US)

(72) Inventors: **Zachary Robert Sweitzer**, Keyport, NJ (US); **Lindsey Anne Charbonneau**, Bay City, MI (US)

(73) Assignee: **Shukla Medical**, St. Petersburg, FL (US)

(\*\*) Term: **15 Years**

(21) Appl. No.: **29/711,452**

(22) Filed: **Oct. 31, 2019**

(51) **LOC (13) Cl.** ..... **24-02**

(52) **U.S. Cl.**  
USPC ..... **D24/133**

(58) **Field of Classification Search**  
USPC ..... D24/146, 147, 143–145, 127, 133;  
D8/21, 47, 98  
CPC . A61B 17/0642; A61B 17/16; A61B 17/1604;  
A61B 17/1659; A61B 17/17; A61B  
17/1728; A61B 17/1732; A61B 17/1735;  
A61B 17/30; A61B 17/32; A61B  
17/320052; A61B 17/3205; A61B  
17/3211; A61B 17/3213; A61B 2017/922;  
A61C 17/16; A61C 17/18; A61C 17/20;  
A61F 2/46; A61F 2/4601; A61F 2/4603;  
A61F 2/4605; A61F 2/4606; A61F  
2/4607; A61F 2/4609; A61F 2/461; A61F  
2/4612; A61F 2002/30136; A61F  
2002/4619; A61F 2002/4622; A61F  
2002/4625

See application file for complete search history.

(56) **References Cited**

U.S. PATENT DOCUMENTS

D230,097	S	*	1/1974	Rylee	.....	D24/133
D320,081	S	*	9/1991	Johnson	.....	D24/145
D383,841	S	*	9/1997	Runciman	.....	D24/133
D467,657	S	*	12/2002	Scribner	.....	D24/133
D710,997	S	*	8/2014	Thon	.....	D24/145
D776,277	S	*	1/2017	Prendergast	.....	D24/147
D888,950	S	*	6/2020	Kuchta	.....	D24/144
2013/0261626	A1	*	10/2013	Chavarria	.....	A61F 2/4612 606/79
2021/0093465	A1	*	4/2021	Sweitzer	.....	A61F 2/4603
2021/0093466	A1	*	4/2021	Bravman	.....	A61F 2/4603

FOREIGN PATENT DOCUMENTS

GB 9007721519-0018 \* 2/2020

\* cited by examiner

*Primary Examiner* — Lilyana Bekic

*Assistant Examiner* — Lee D. Starr

(74) *Attorney, Agent, or Firm* — Kim IP Law Group LLC

(57) **CLAIM**

The ornamental design for a surgical punch, as shown and described.

**DESCRIPTION**

FIG. 1 is a perspective view of a surgical punch in accordance with the new design;  
FIG. 2 is a left side view of the surgical punch of FIG. 1, the right side being a mirror image;  
FIG. 3 is a front view of the surgical punch of FIG. 1;  
FIG. 4 is a rear view of the surgical punch of FIG. 1;  
FIG. 5 is a bottom plan view of the surgical punch of FIG. 1; and,  
FIG. 6 is a top plan view of the surgical punch of FIG. 1.  
The broken lines in the figures are directed to portions of the surgical punch that form no part of the claim.

**1 Claim, 6 Drawing Sheets**

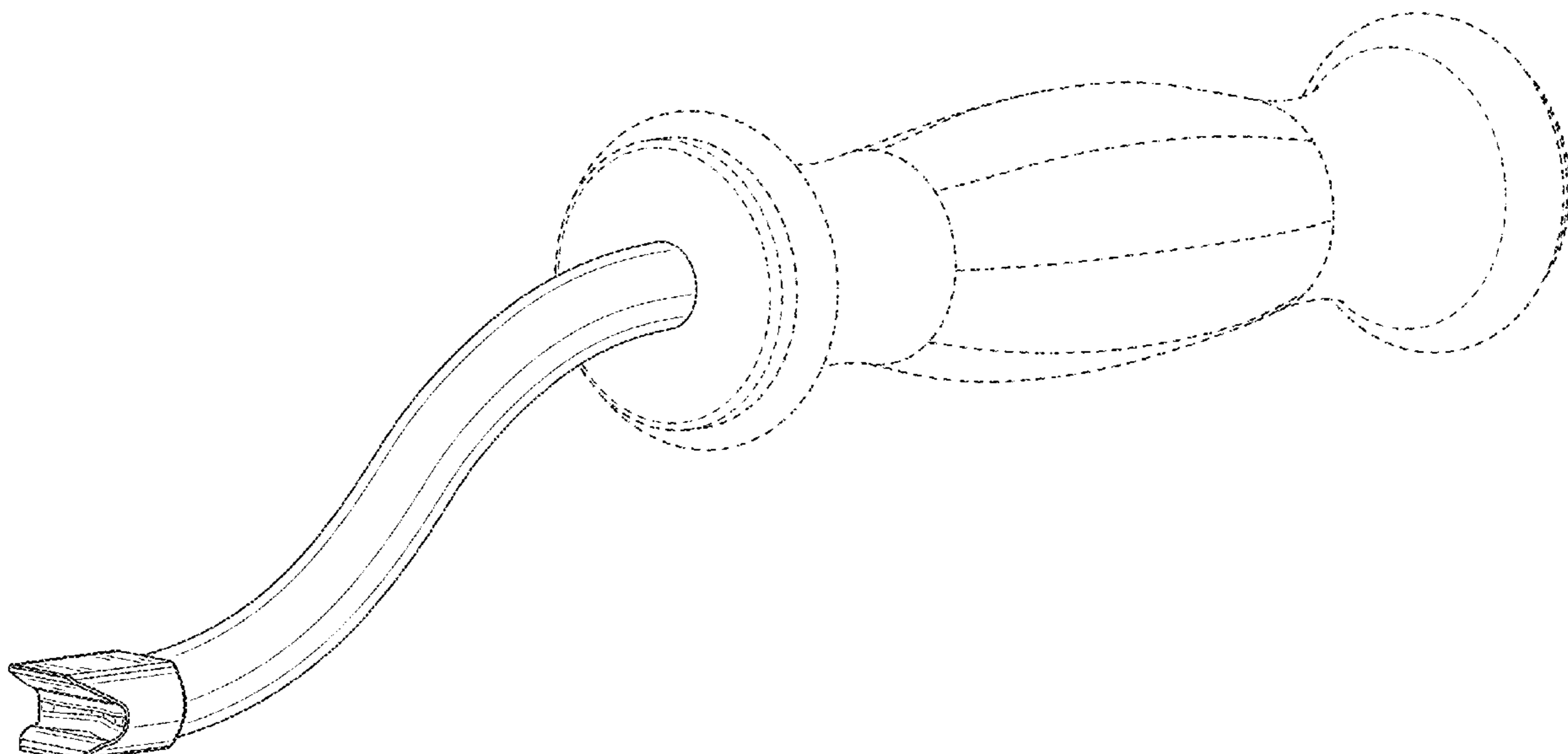

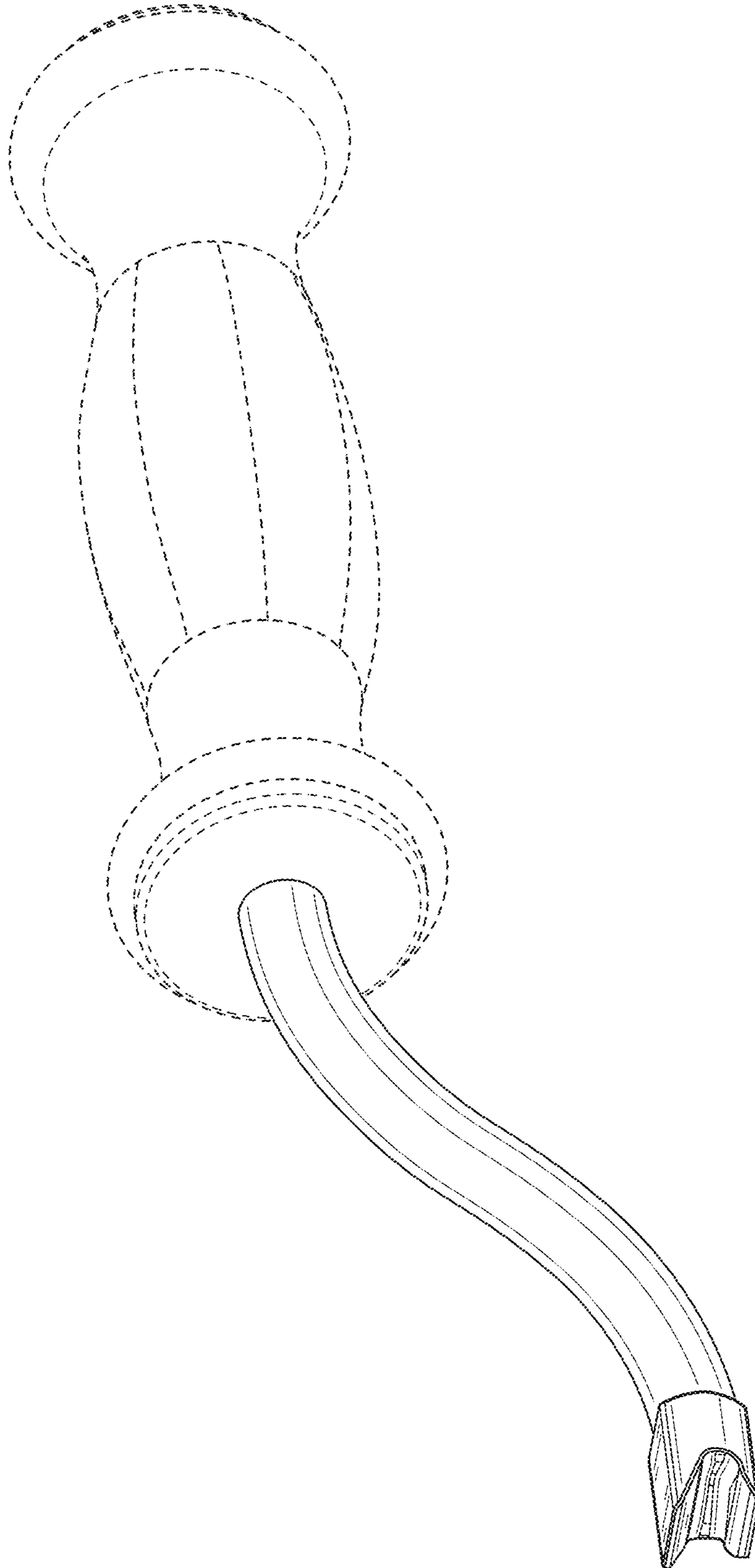

FIG. 1

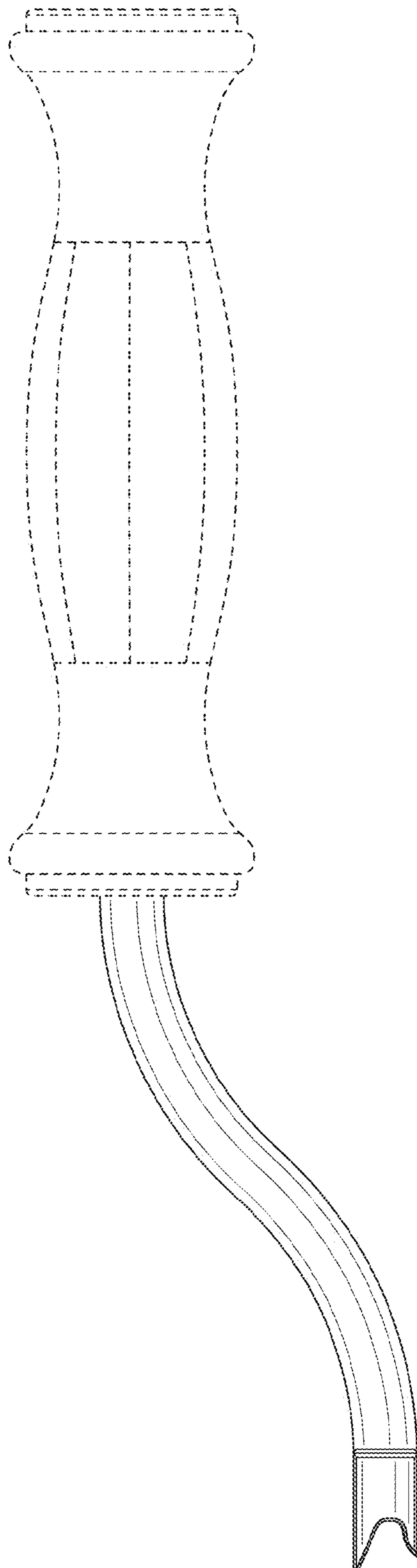

FIG. 2

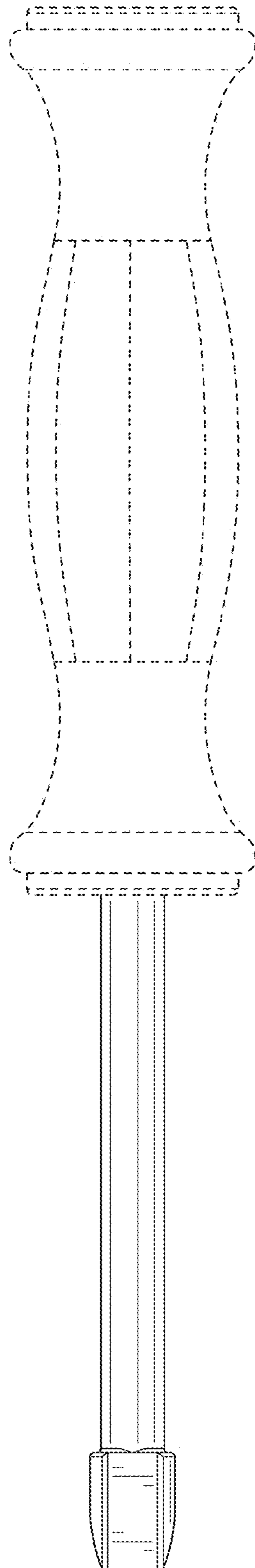

FIG. 3

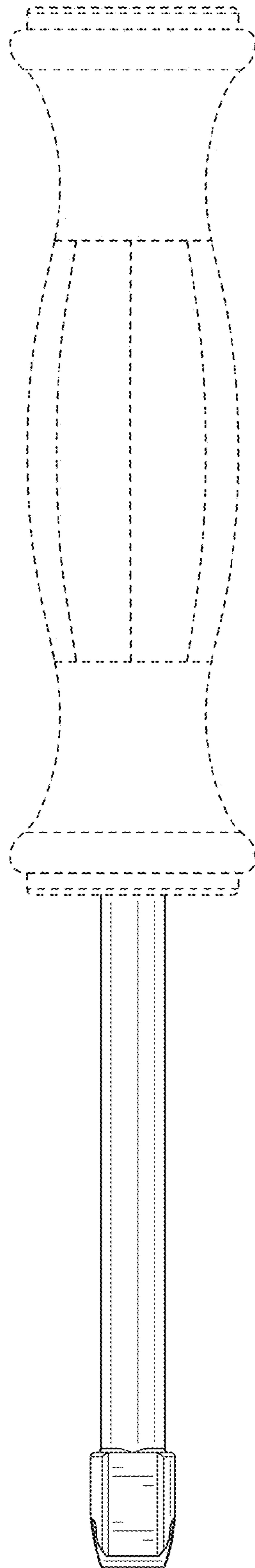

FIG. 4

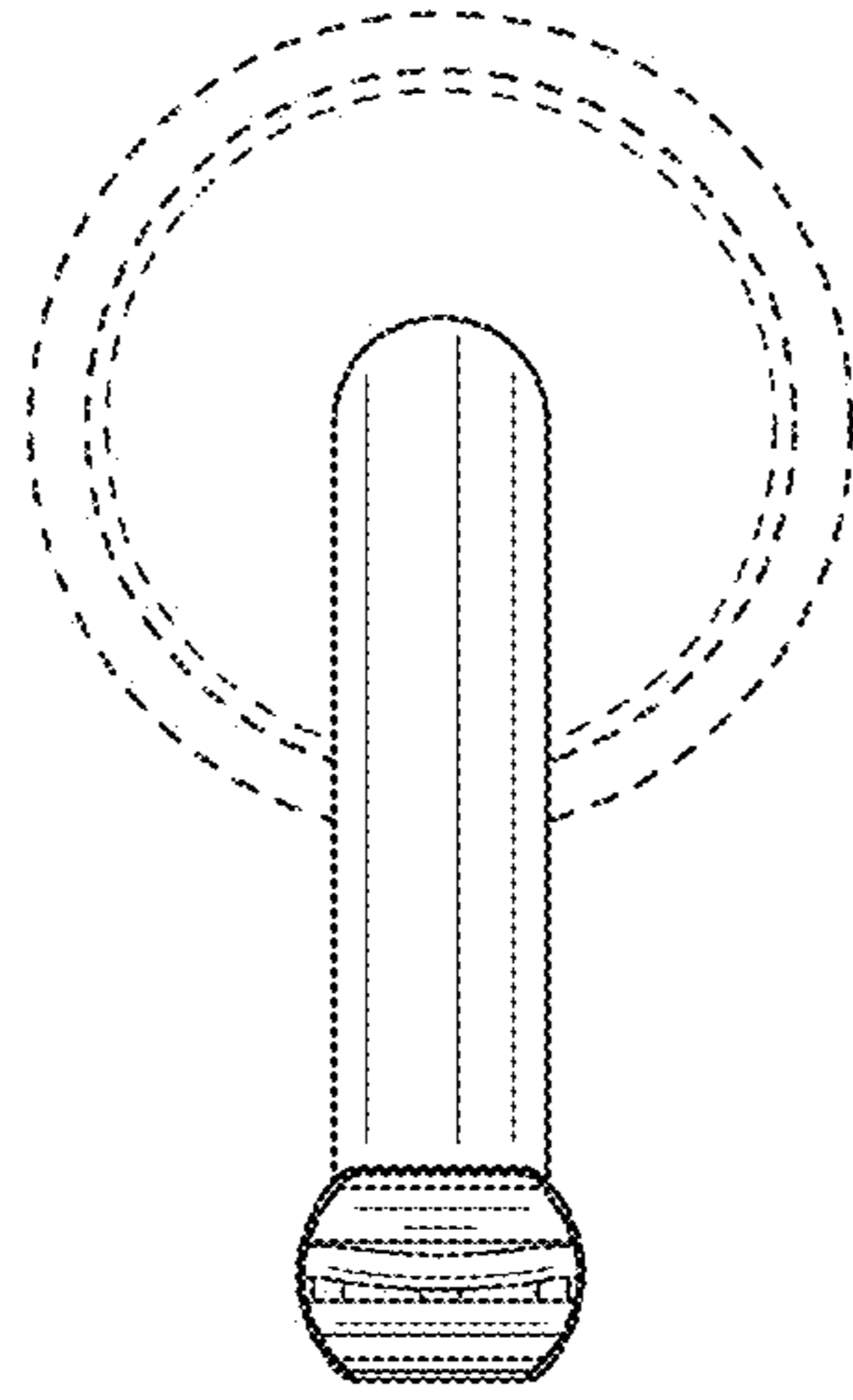

FIG. 5

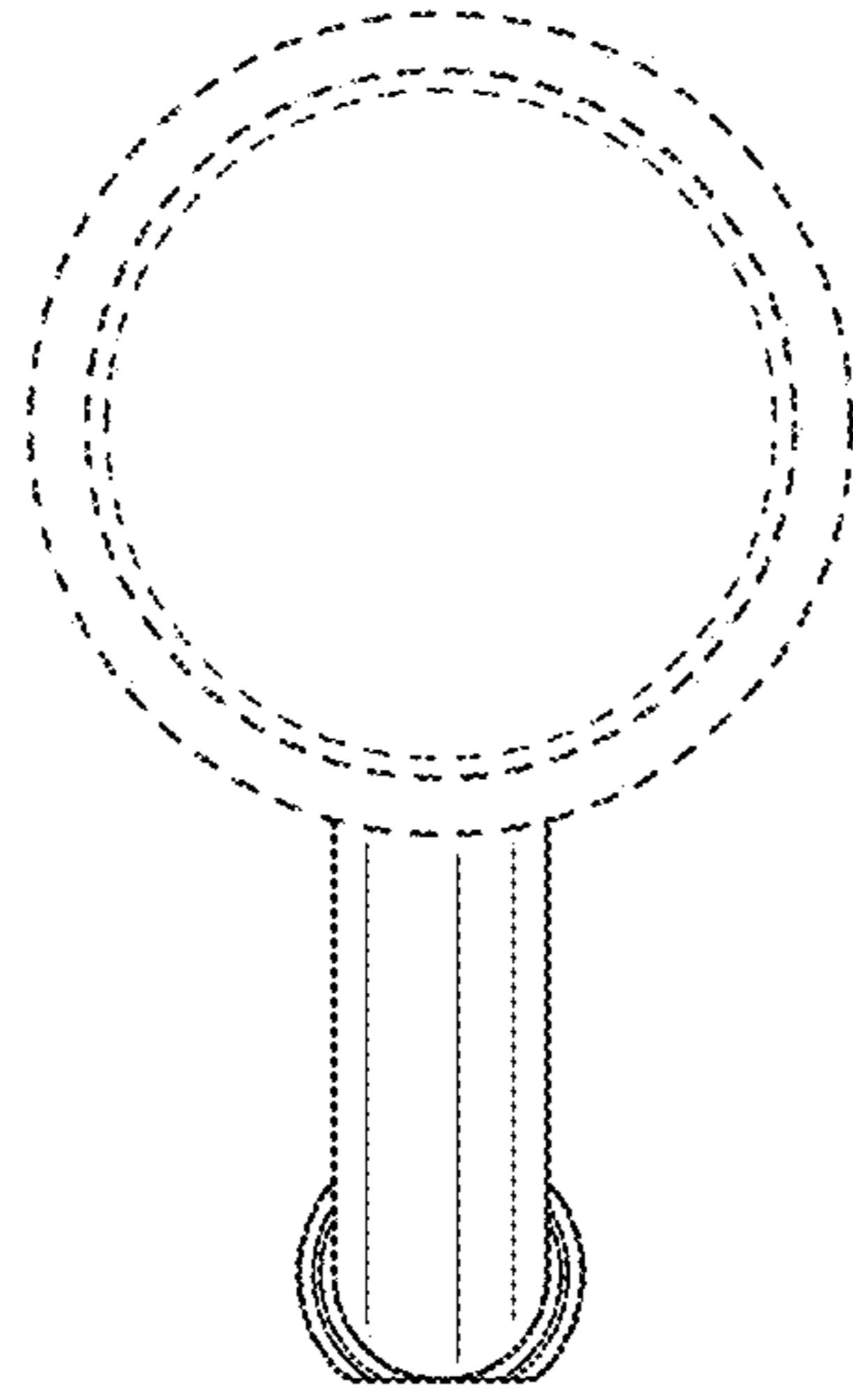

FIG. 6