



US00D933181S

(12) **United States Design Patent** (10) **Patent No.:** **US D933,181 S**  
**Gally** (45) **Date of Patent:** **\*\* Oct. 12, 2021**

(54) **PELLET STOVE HOPPER**  
(71) Applicant: **John Gally**, Salt Lake City, UT (US)  
(72) Inventor: **John Gally**, Salt Lake City, UT (US)  
(\*\*) Term: **15 Years**  
(21) Appl. No.: **29/591,446**  
(22) Filed: **Jan. 19, 2017**  
(51) **LOC (13) Cl.** ..... **23-03**  
(52) **U.S. Cl.**  
USPC ..... **D23/347**  
(58) **Field of Classification Search**  
USPC ..... D23/332, 314, 343, 348, 350, 346, 342,  
D23/347, 372; D7/332-337, 402-405,  
D7/352, 408  
CPC ..... F24C 1/16; F24C 5/00; F24C 3/14; A47J  
33/00; A47J 37/0763; A47J 37/07; F24B  
1/18; F24B 1/182; F24B 1/1808; F24B  
1/181; F24B 1/195; F24B 1/191  
See application file for complete search history.

D450,822 S \* 11/2001 Mills ..... D23/343  
D738,476 S \* 9/2015 Lee ..... D23/343  
D791,923 S \* 7/2017 Galluzzo ..... D23/343

\* cited by examiner

*Primary Examiner* — Ania Aman  
(74) *Attorney, Agent, or Firm* — David R. Conklin;  
Kirton McConkie

(57) **CLAIM**

The ornamental design for a pellet stove hopper, as shown and described.

**DESCRIPTION**

FIG. 1 is a front elevation view of the pellet stove hopper showing my new design;  
FIG. 2 is a rear elevation view thereof;  
FIG. 3 is a right side elevation view thereof;  
FIG. 4 is a left side elevation view thereof;  
FIG. 5 is a top plan view thereof;  
FIG. 6 is a front elevation view of the hopper removed from the stove base for ease of illustration;  
FIG. 7 is a rear elevation view of the hopper thereof;  
FIG. 8 is a right side elevation view of the hopper thereof;  
FIG. 9 is a left side elevation view thereof;  
FIG. 10 is a top plan view of the hopper thereof;  
FIG. 11 is a bottom elevation view of the hopper thereof;  
FIG. 12 is a cross-sectional view of the hopper taken along lines 12-12 of FIG. 6 and lines 12'-12' of FIG. 10 thereof;  
FIG. 13 is a cross-sectional view of the hopper taken along line 13-13 of FIG. 8 and lines 13'-13' of FIG. 10 thereof; and,  
FIG. 14 is a cross-sectional view of the hopper taken along lines 14-14 of FIG. 6 and lines 14'-14' of FIG. 10 thereof.  
The broken lines shown in the drawings are for the purpose of illustrating portions of the article and form no part of the claimed design.

(56) **References Cited**

**U.S. PATENT DOCUMENTS**

D251,501 S \* 4/1979 Peterman ..... D23/343  
D265,339 S \* 7/1982 Baughman ..... D23/343  
D266,582 S \* 10/1982 Schwartz ..... D23/343  
D267,193 S \* 12/1982 Salce ..... D23/343  
D269,368 S \* 6/1983 Schrader ..... D23/343  
D359,115 S \* 6/1995 Schroeter ..... D23/342  
D377,828 S \* 2/1997 Wilson ..... D23/343  
D384,405 S \* 9/1997 Wilson ..... D23/339  
D397,776 S \* 9/1998 Heger ..... D23/343

**1 Claim, 10 Drawing Sheets**

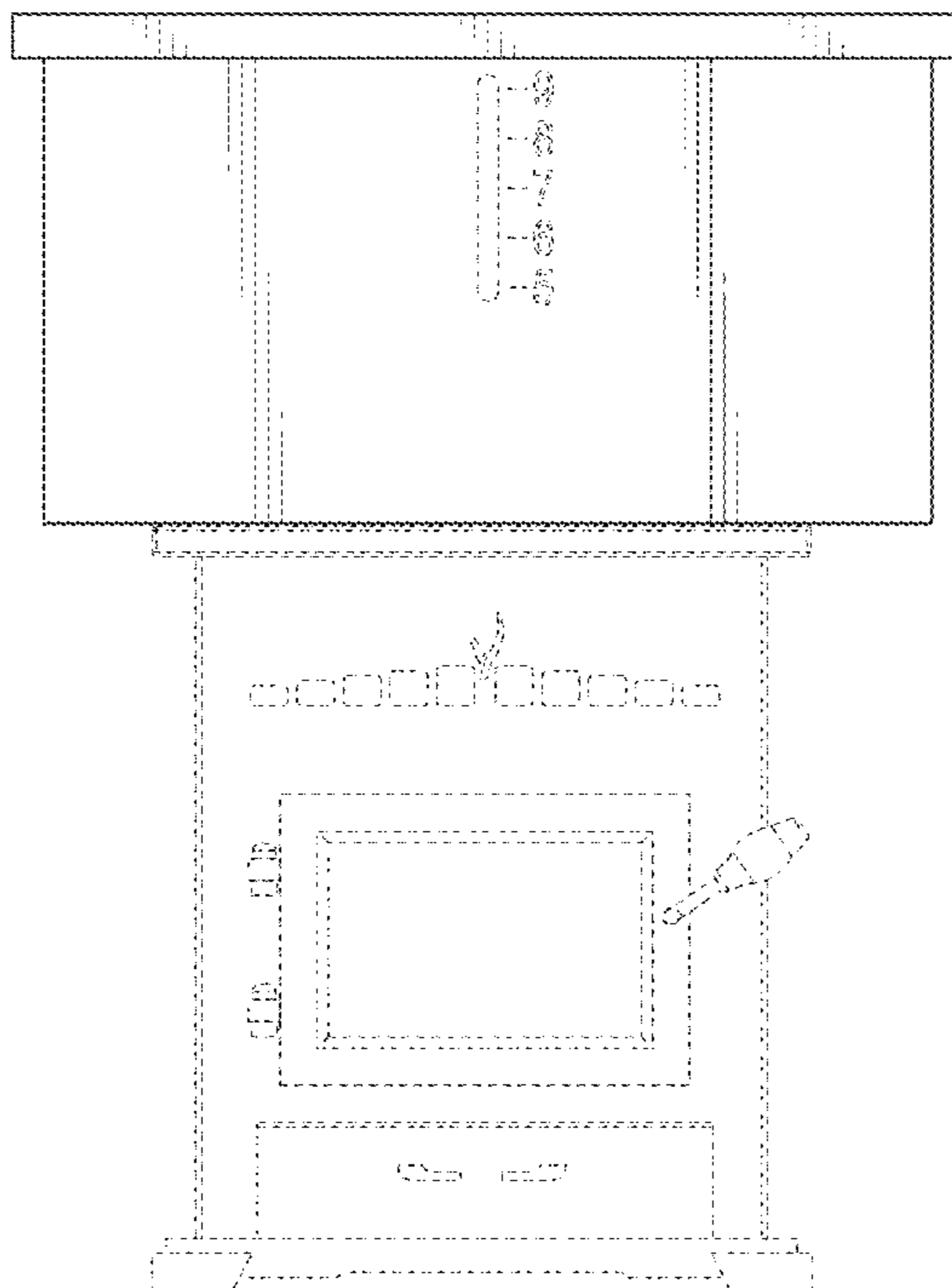

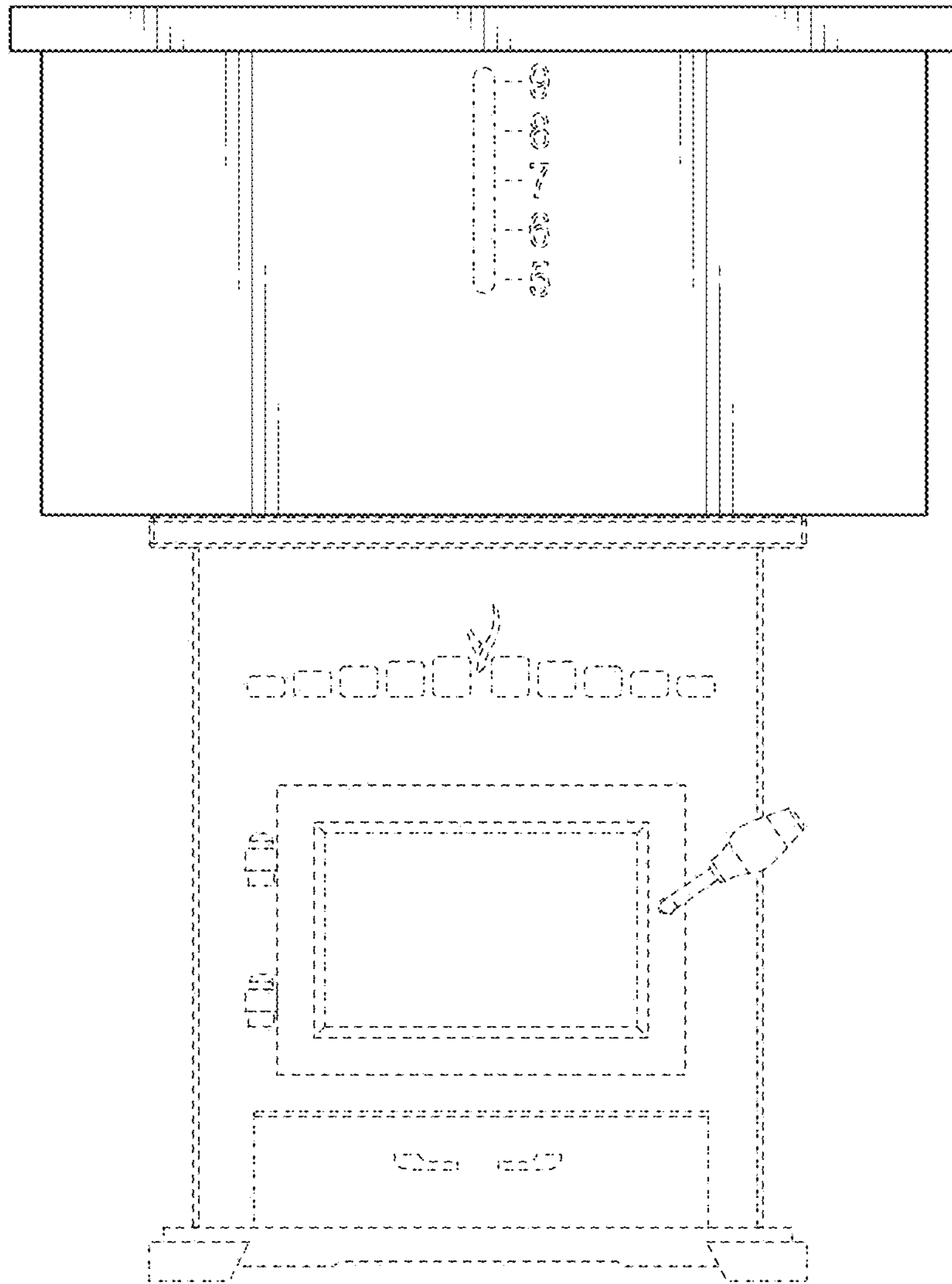

FIG. 1

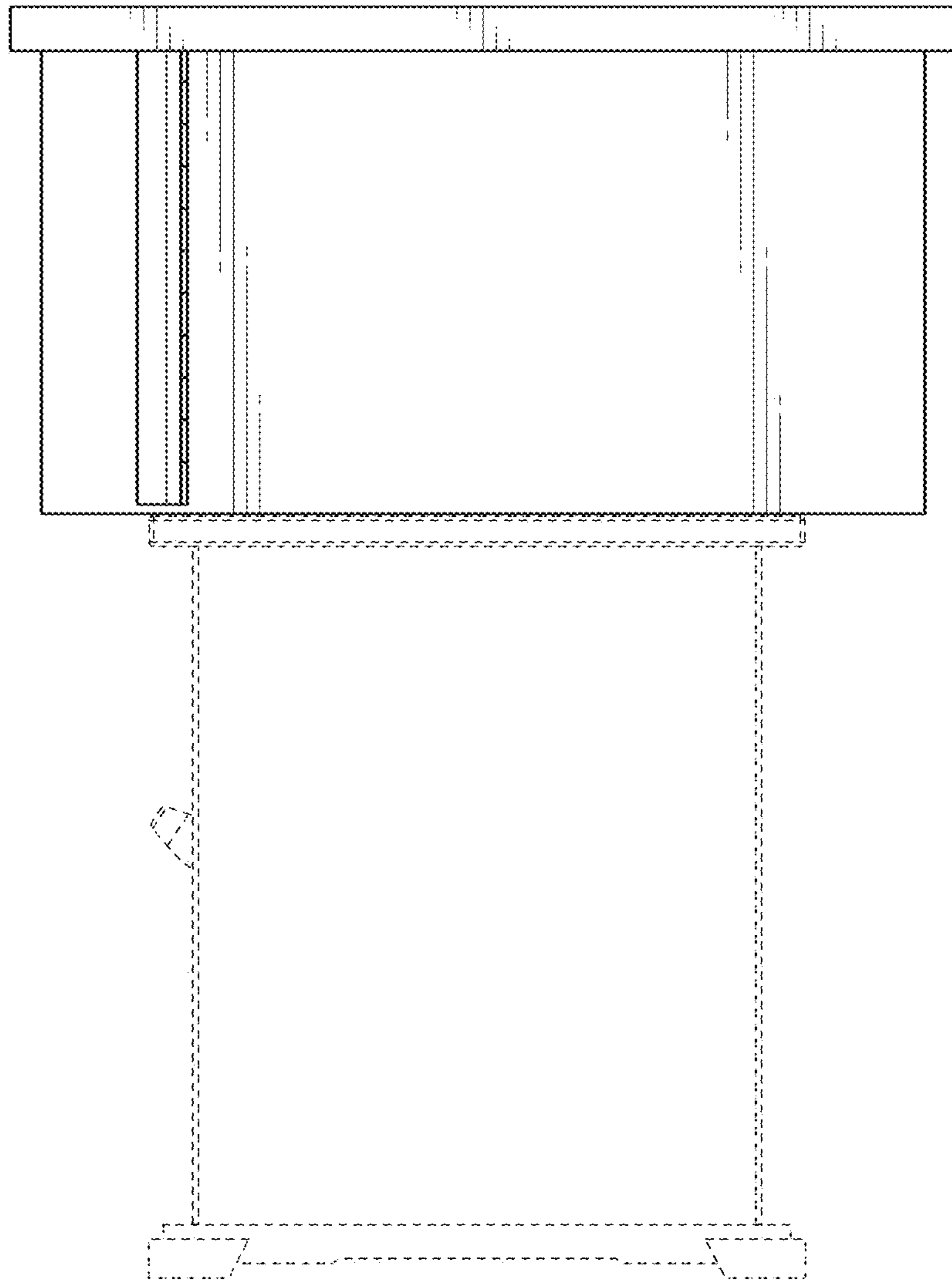

FIG. 2

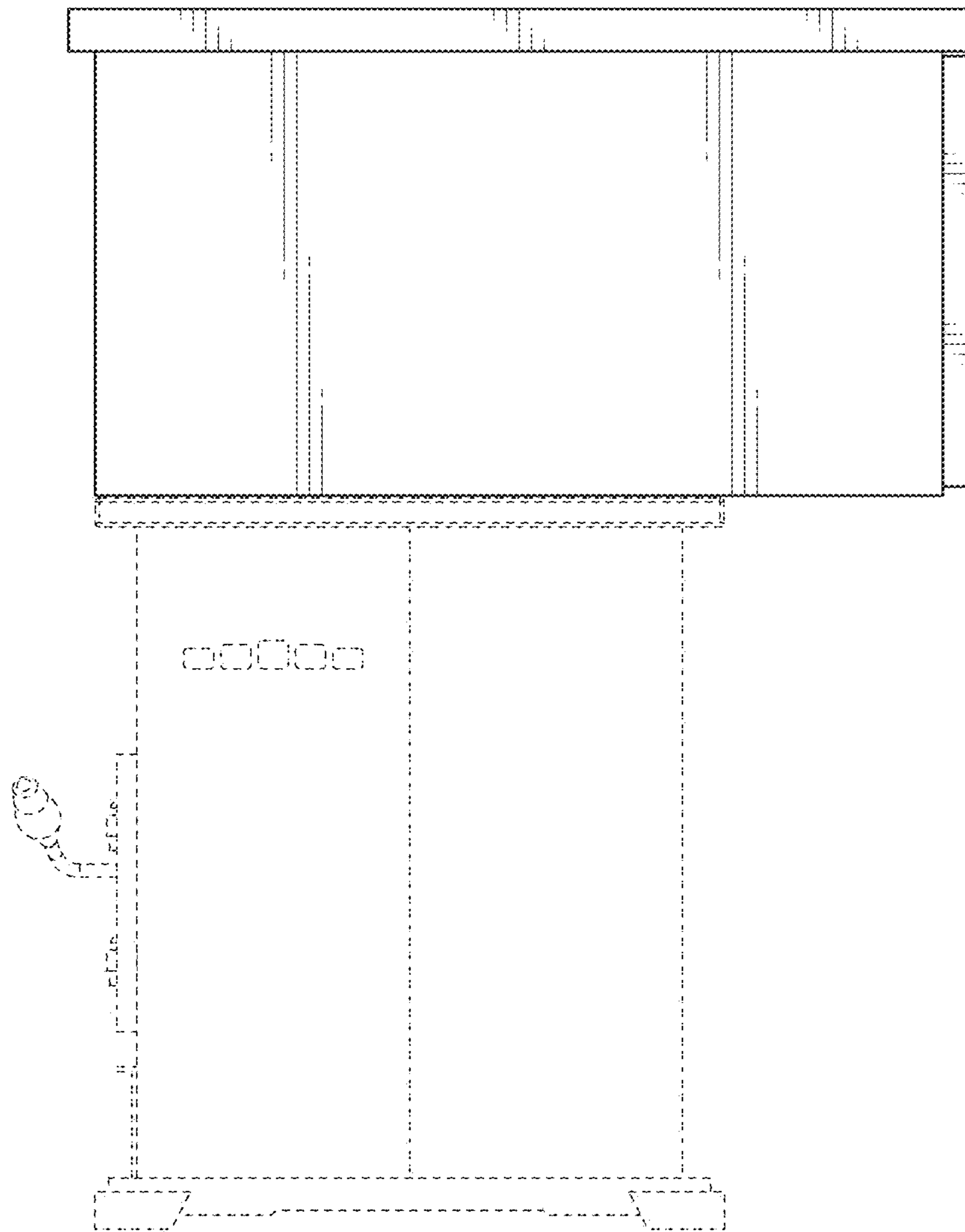

FIG. 3

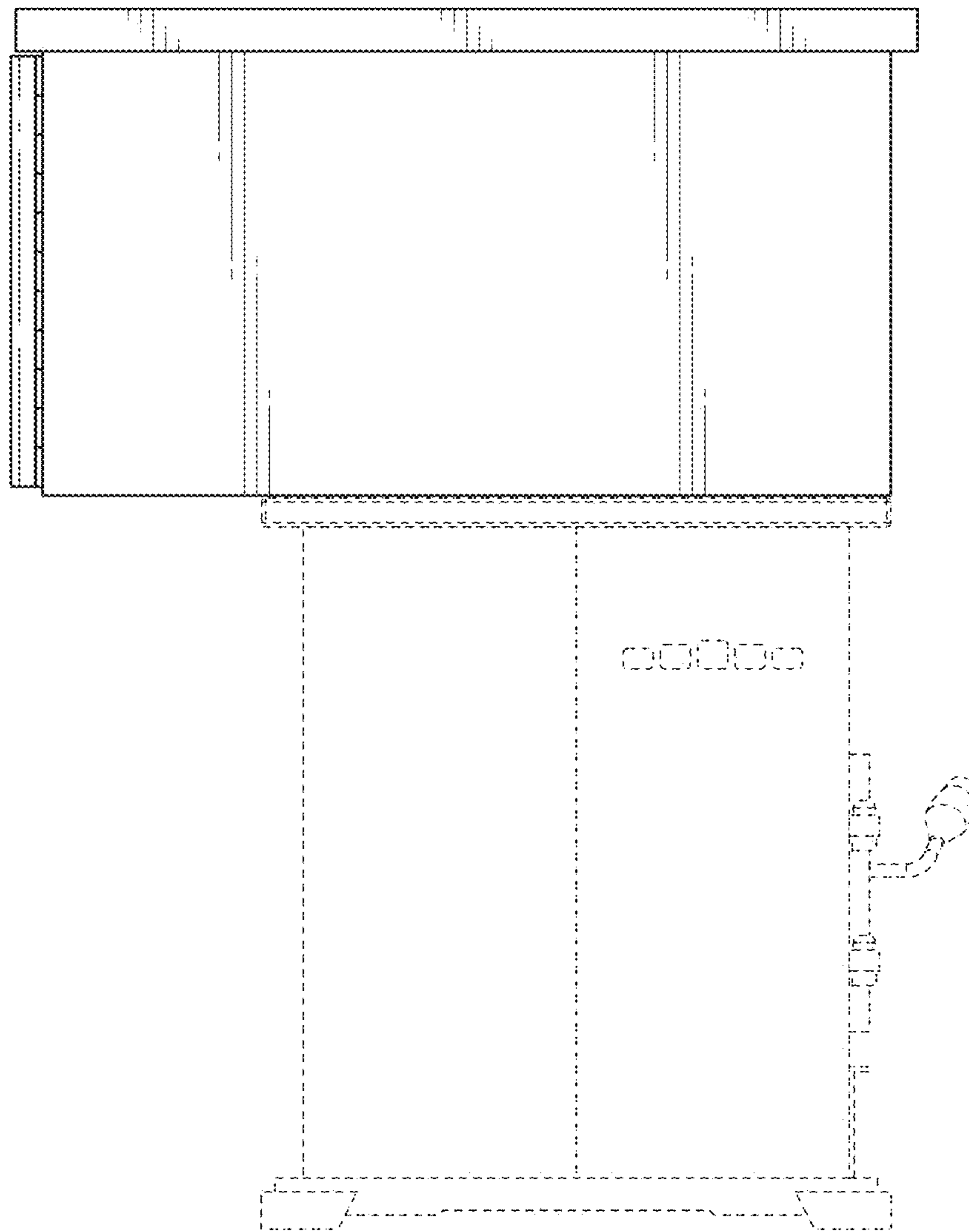

FIG. 4

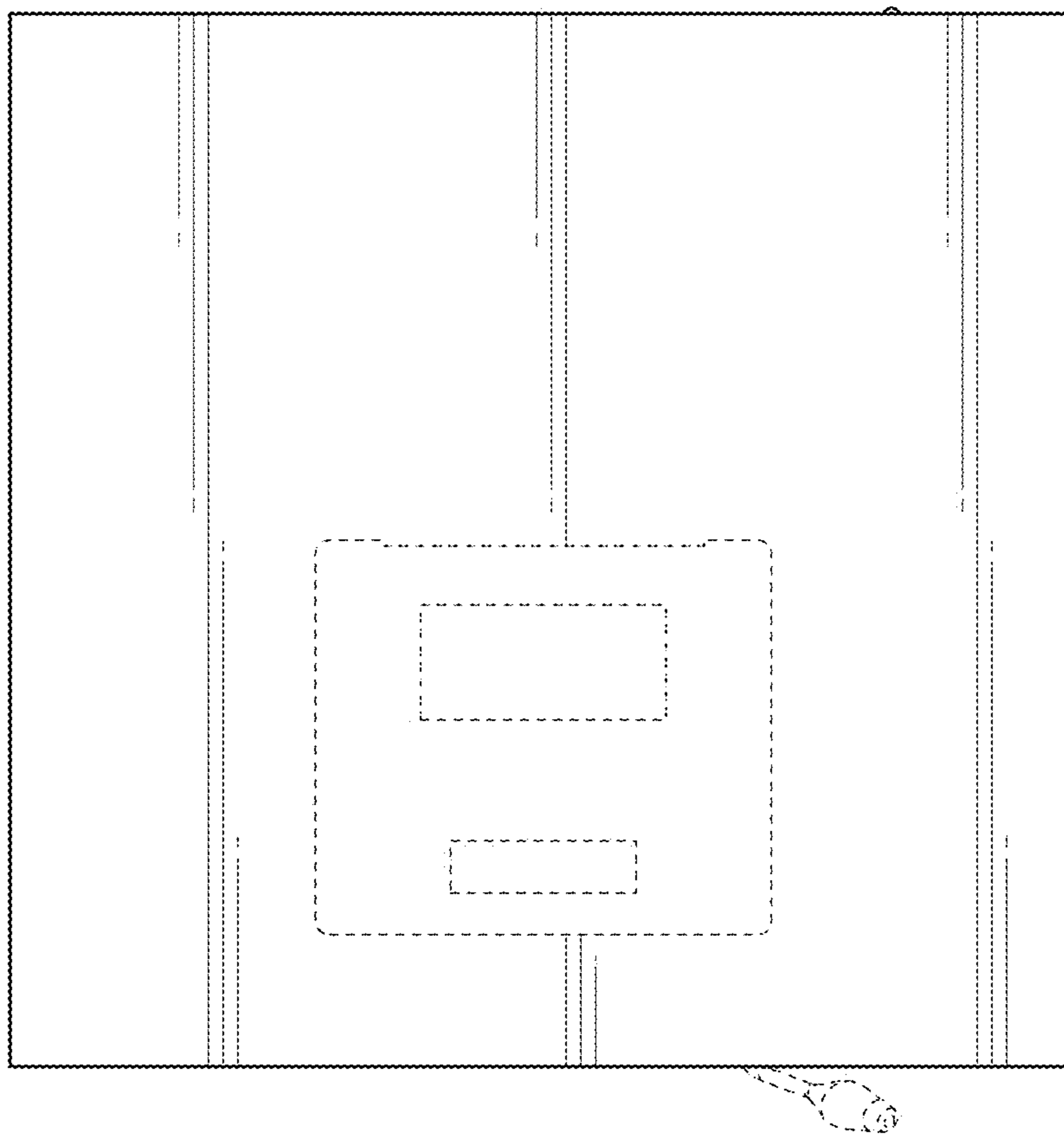

FIG. 5

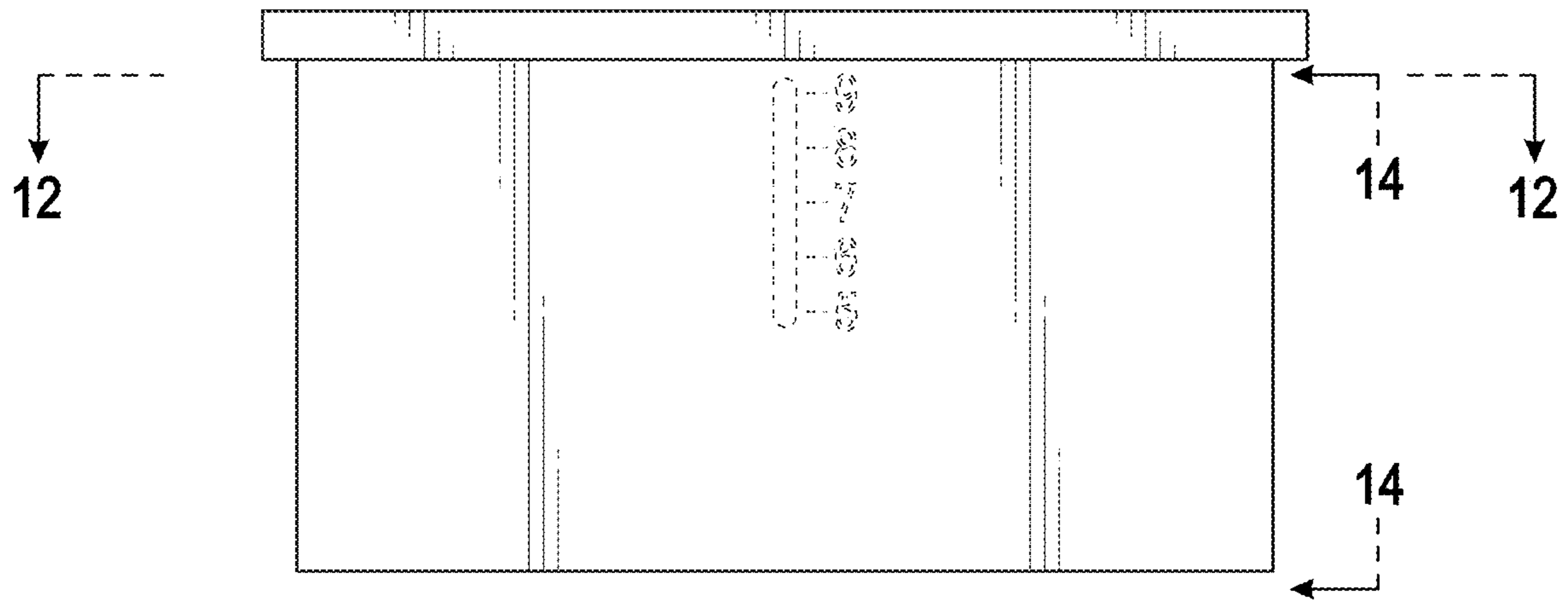

FIG. 6

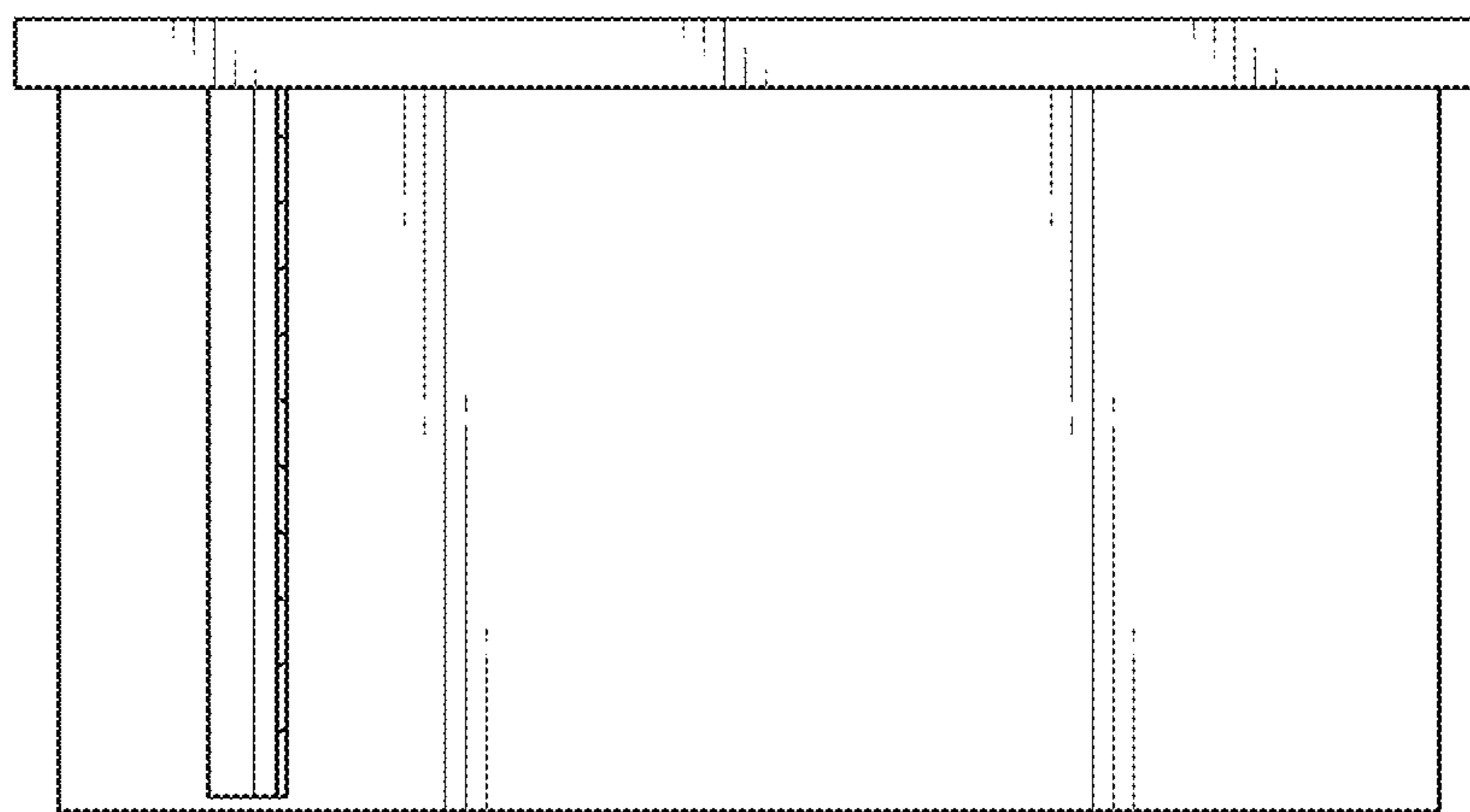

FIG. 7

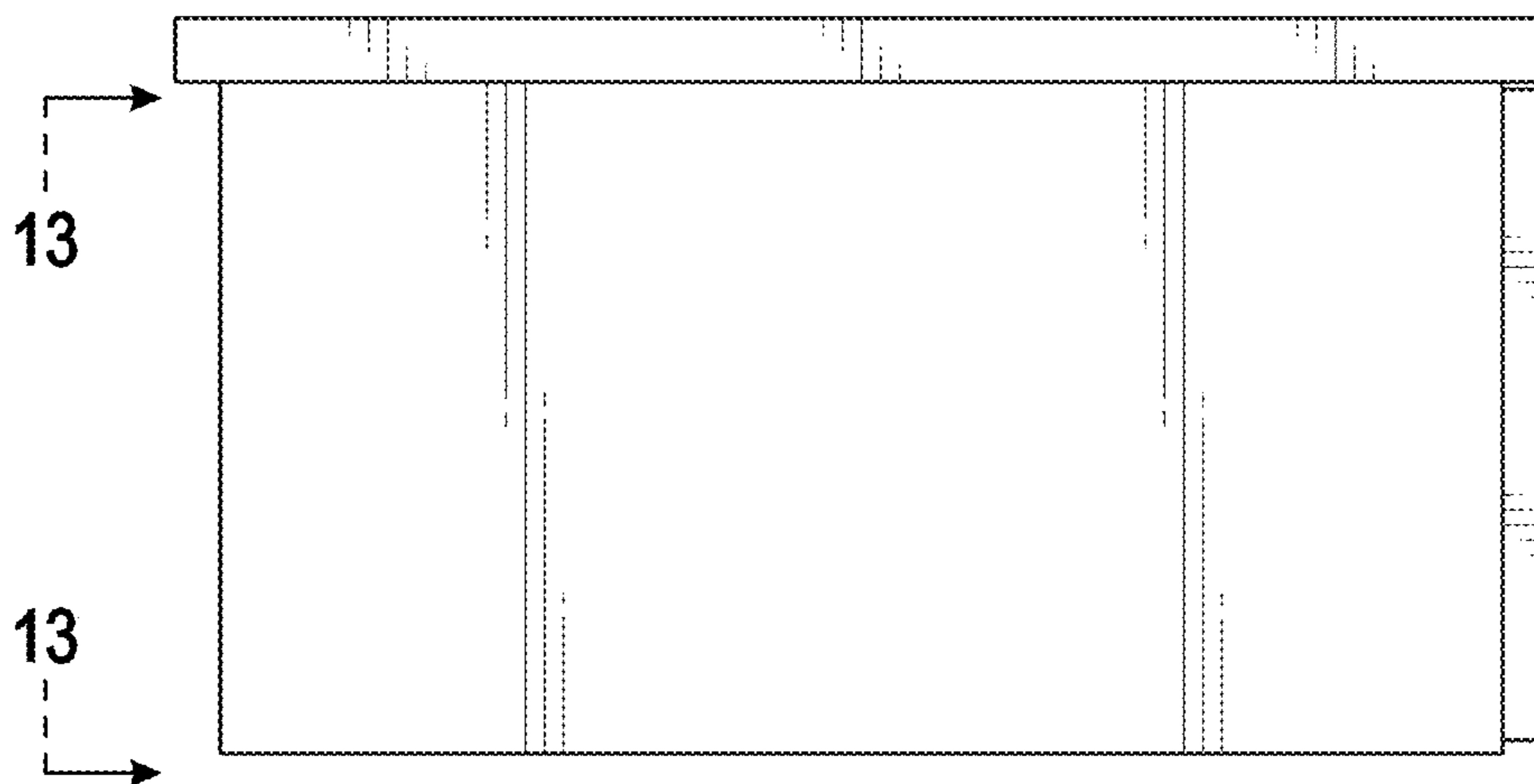

FIG. 8

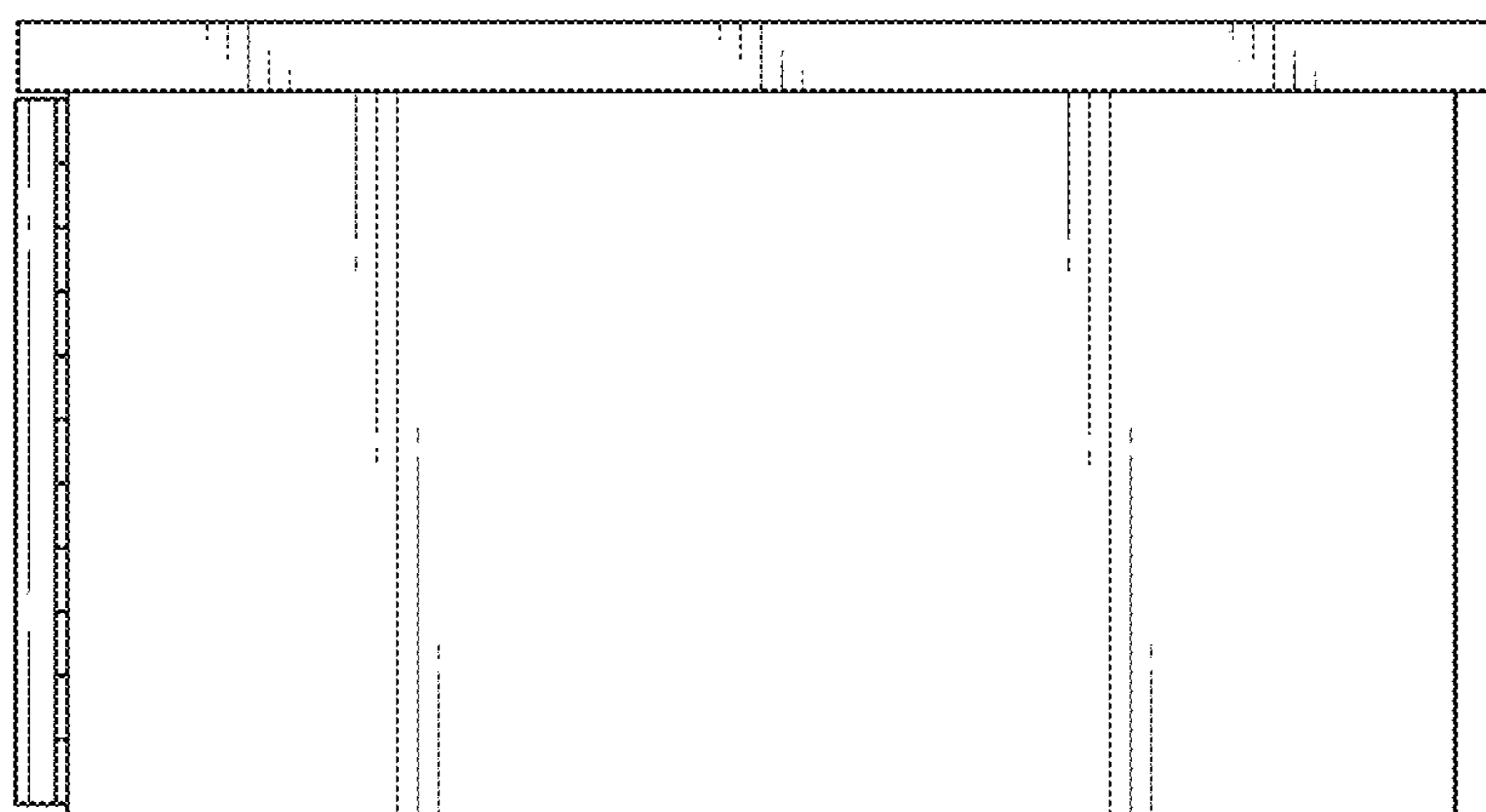

FIG. 9



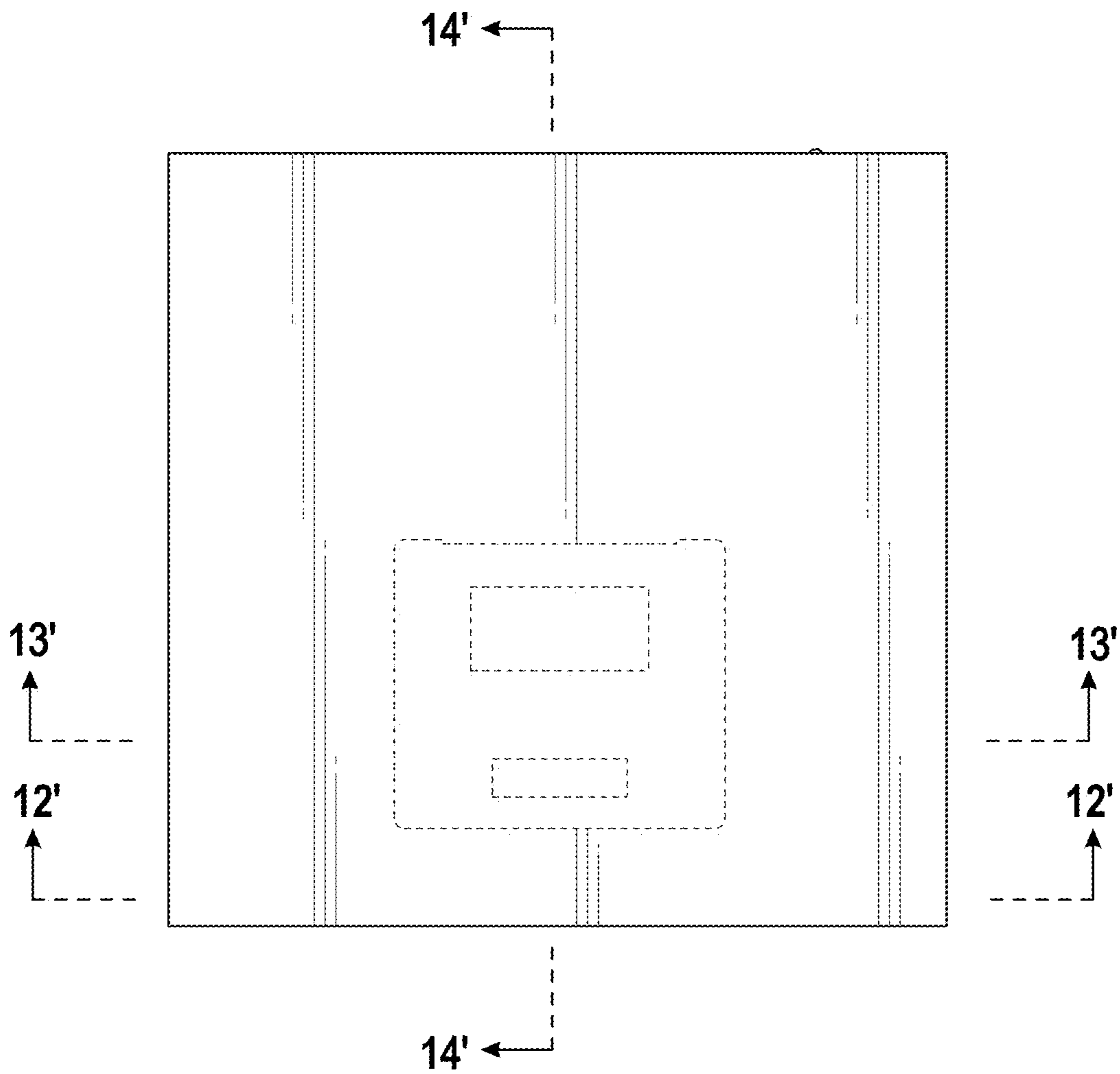

FIG. 10

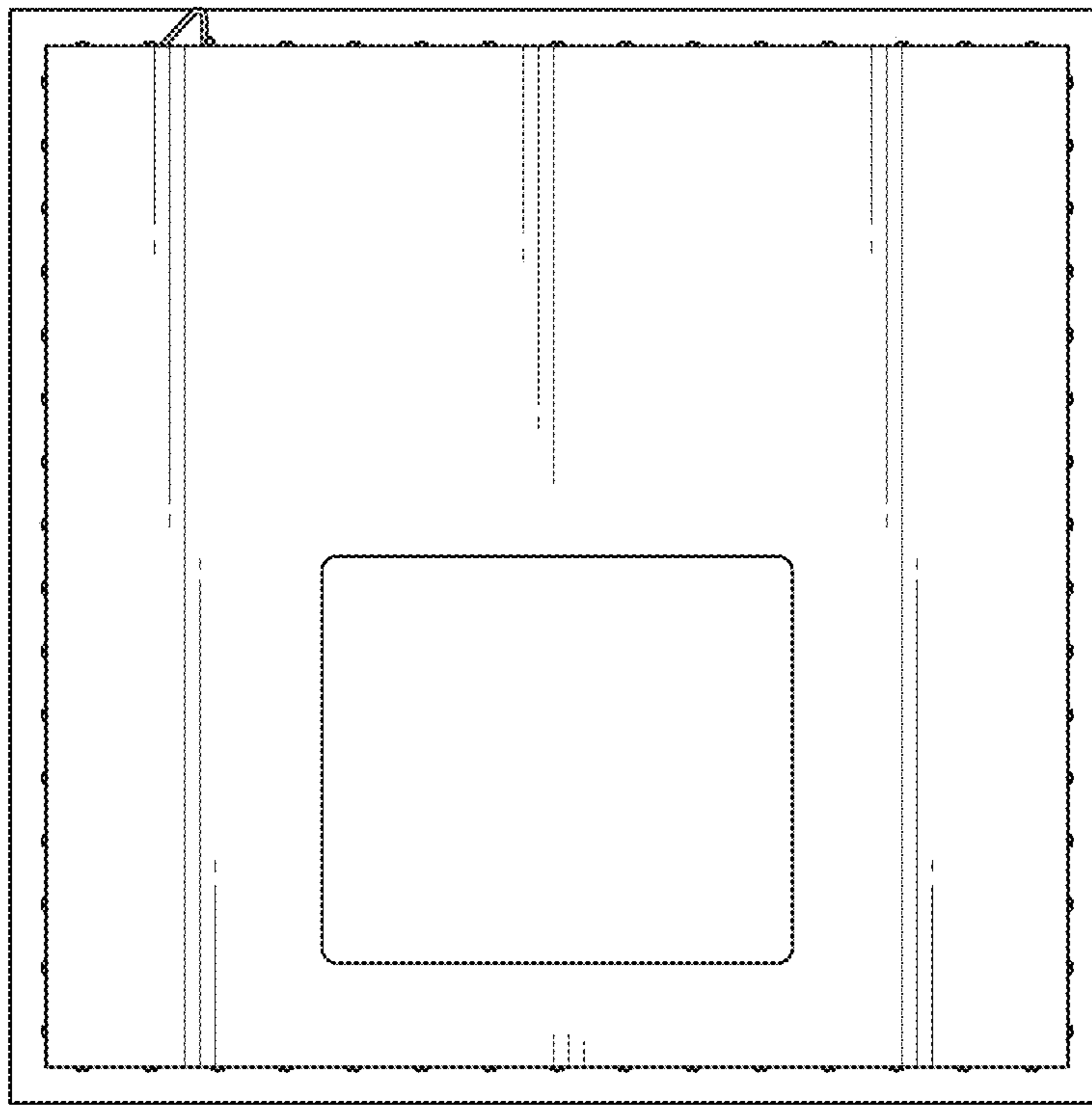

FIG. 11

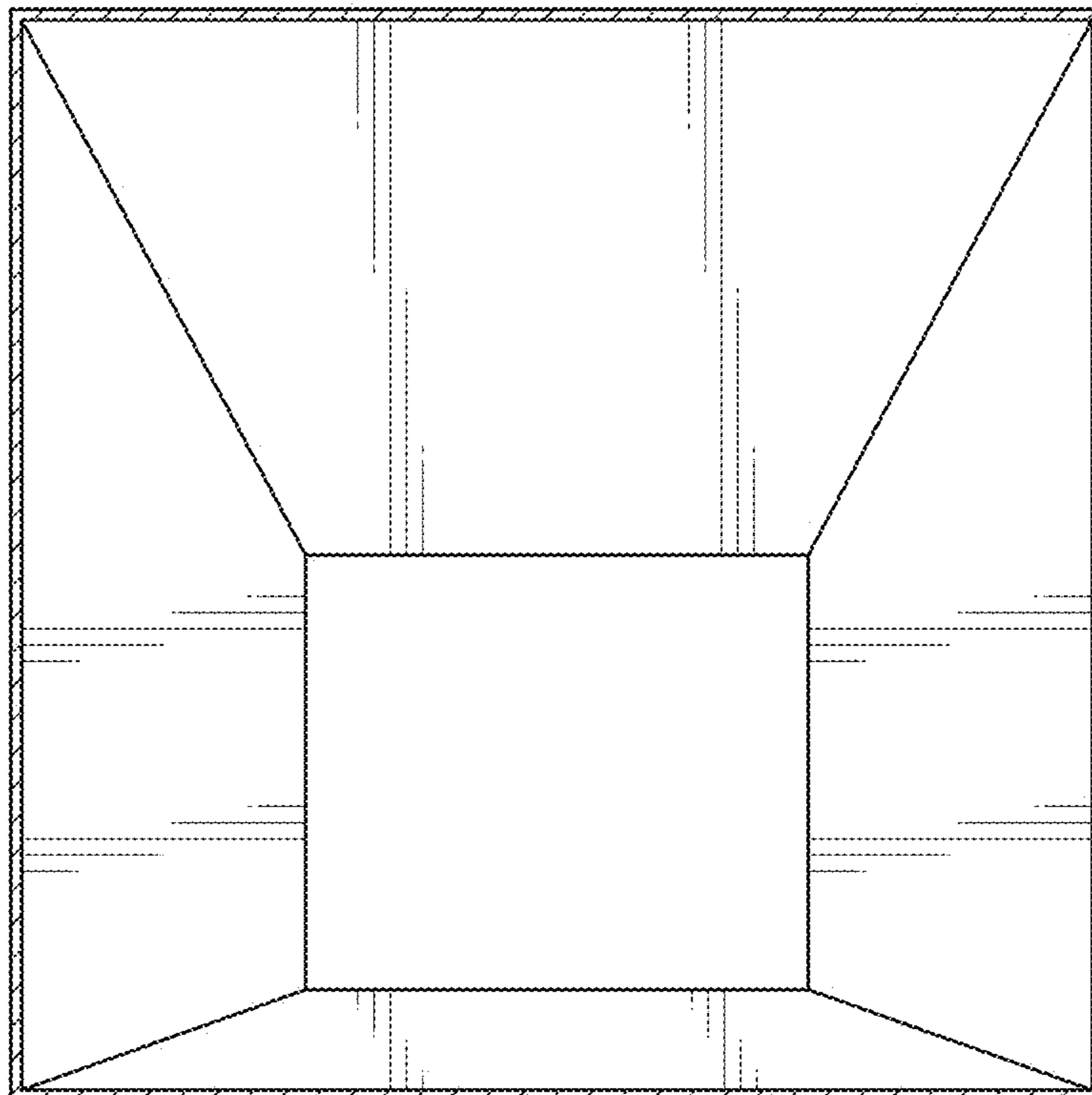

FIG. 12

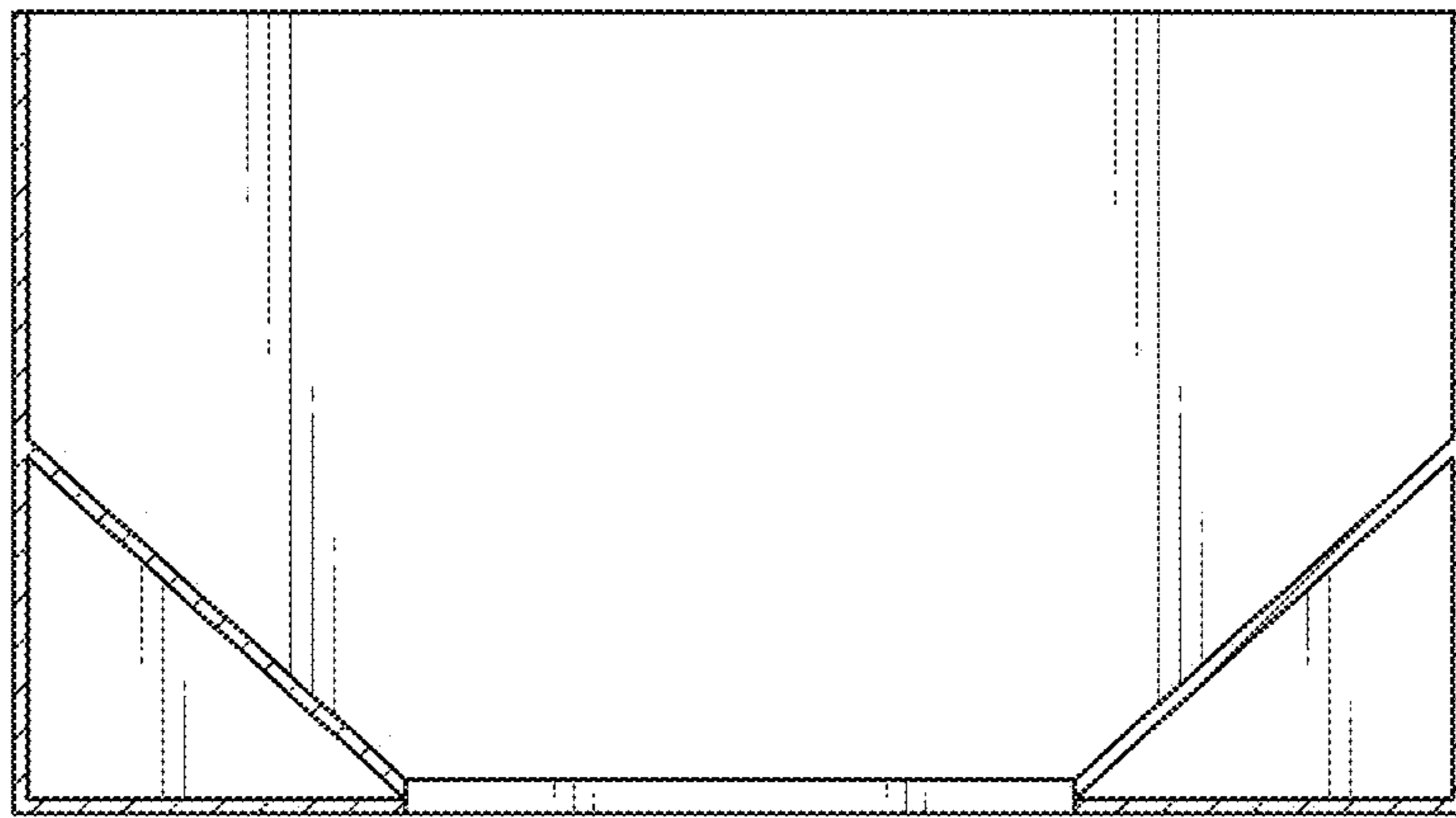

FIG. 13

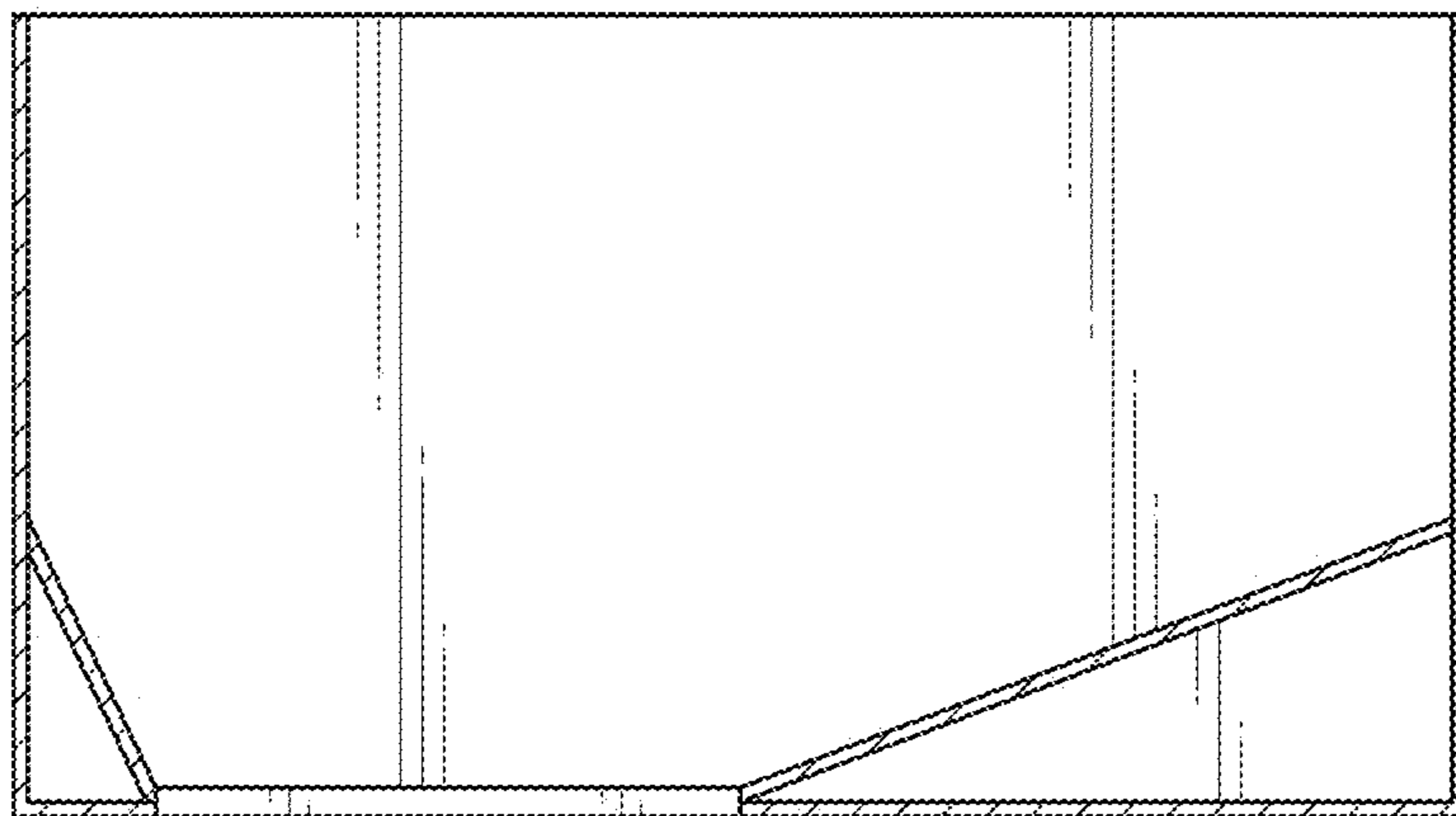

FIG. 14