



US00D933064S

(12) **United States Design Patent**  
**DeMaio**

(10) **Patent No.:** **US D933,064 S**  
(45) **Date of Patent:** **\*\* Oct. 12, 2021**

(54) **CONNECTABLE COMPANION COMPUTING DEVICE**

**DESCRIPTION**

(71) Applicant: **Robert Charles DeMaio**, Incline Village, NV (US)

(72) Inventor: **Robert Charles DeMaio**, Incline Village, NV (US)

(\*\*) Term: **15 Years**

(21) Appl. No.: **29/788,688**

(22) Filed: **Jul. 17, 2021**

**Related U.S. Application Data**

(60) Continuation-in-part of application No. 29/769,530, filed on Feb. 5, 2021, now Pat. No. Des. 928,778, (Continued)

(51) **LOC (13) Cl.** ..... **14-02**

(52) **U.S. Cl.**  
USPC ..... **D14/341**

(58) **Field of Classification Search**  
USPC ..... D14/341, 315–318, 371, 374, 388–389, D14/138 G, 138 R, 138 AD, 138 C, (Continued)

(56) **References Cited**

**U.S. PATENT DOCUMENTS**

7,408,698 B2\* 8/2008 Kuo ..... G02F 1/16757  
359/296  
9,541,962 B2\* 1/2017 Siddiqui ..... E05D 1/00  
(Continued)

*Primary Examiner* — Christian P. McLean

*Assistant Examiner* — Holly M Rodriguez

(74) *Attorney, Agent, or Firm* — Tatonetti IP

(57) **CLAIM**

I claim the ornamental design for a connectable companion computing device, as shown and described.

FIG. 1 is a front, bottom, right perspective view of a connectable companion computing device according to a first embodiment in which the connectors are extended, showing my new design;

FIG. 2 is a rear, bottom, left perspective view thereof;

FIG. 3 is a front elevation view thereof;

FIG. 4 is a rear elevation view thereof;

FIG. 5 is a left elevation view thereof;

FIG. 6 is a right elevation view thereof;

FIG. 7 is a top plan view thereof;

FIG. 8 is a bottom plan view thereof;

FIG. 9 is a front, bottom, right perspective view thereof according to a second embodiment in which the connectors are in a contracted position, showing my new design;

FIG. 10 is a rear, bottom, left perspective view thereof;

FIG. 11 is a front elevation view thereof;

FIG. 12 is a rear elevation view thereof;

FIG. 13 is a left elevation view thereof;

FIG. 14 is a right elevation view thereof;

FIG. 15 is a top plan view thereof;

FIG. 16 is a bottom plan view thereof;

FIG. 17 is a front, bottom, right perspective view thereof according to a third embodiment in which the connectors are extended, showing my new design;

FIG. 18 is a front elevation view thereof;

FIG. 19 is a rear elevation view thereof;

FIG. 20 is a left elevation view thereof;

FIG. 21 is a right elevation view thereof;

FIG. 22 is a top plan view thereof;

FIG. 23 is a bottom plan view thereof;

FIG. 24 is a front, bottom, right perspective view of thereof according to a fourth embodiment in which the connectors are contracted, showing my new design;

FIG. 25 is a front elevation view thereof;

FIG. 26 is a rear elevation view thereof;

FIG. 27 is a left elevation view thereof;

FIG. 28 is a right elevation view thereof;

FIG. 29 is a top plan view thereof; and,

FIG. 30 is a bottom plan view thereof.

(Continued)

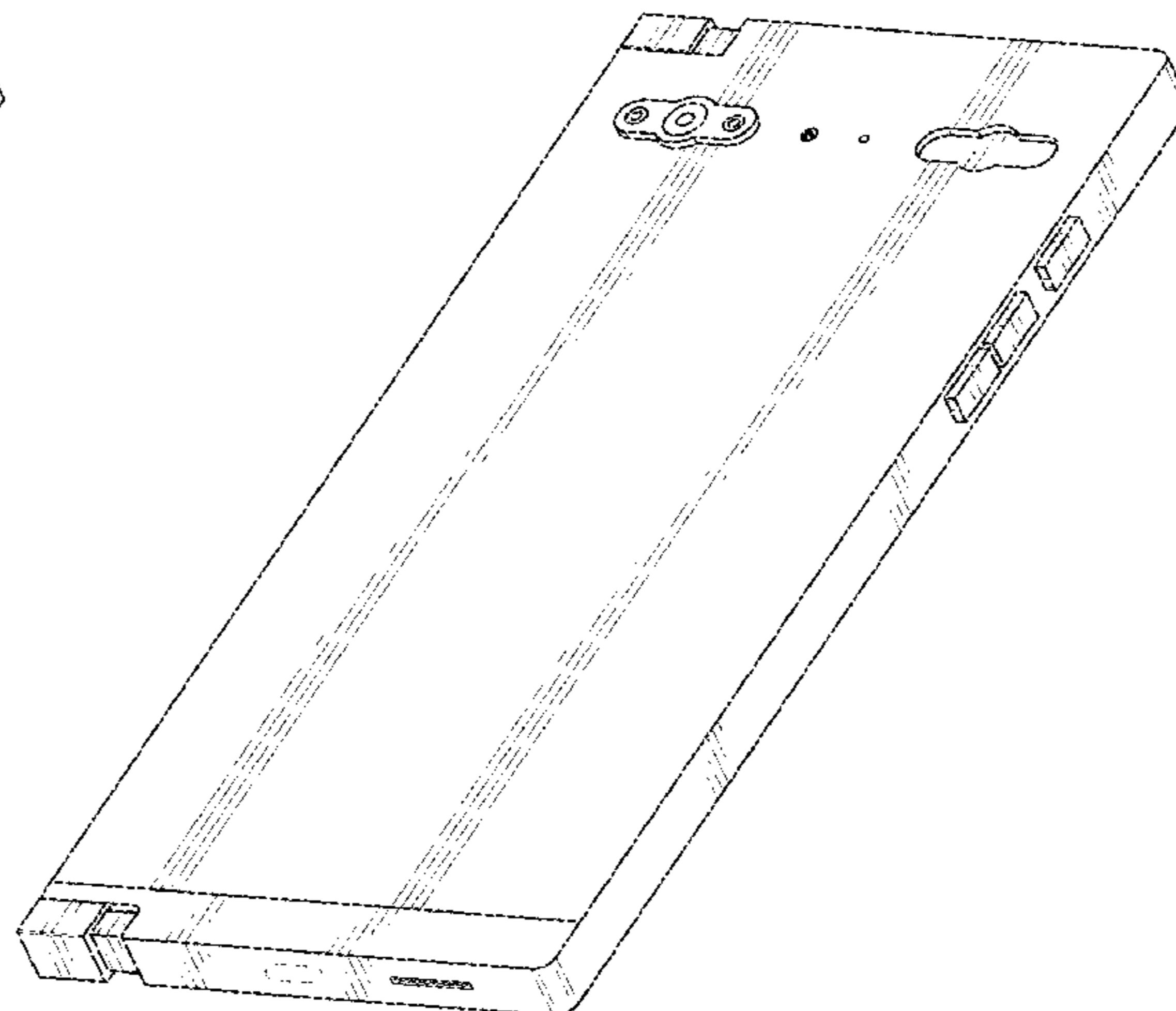
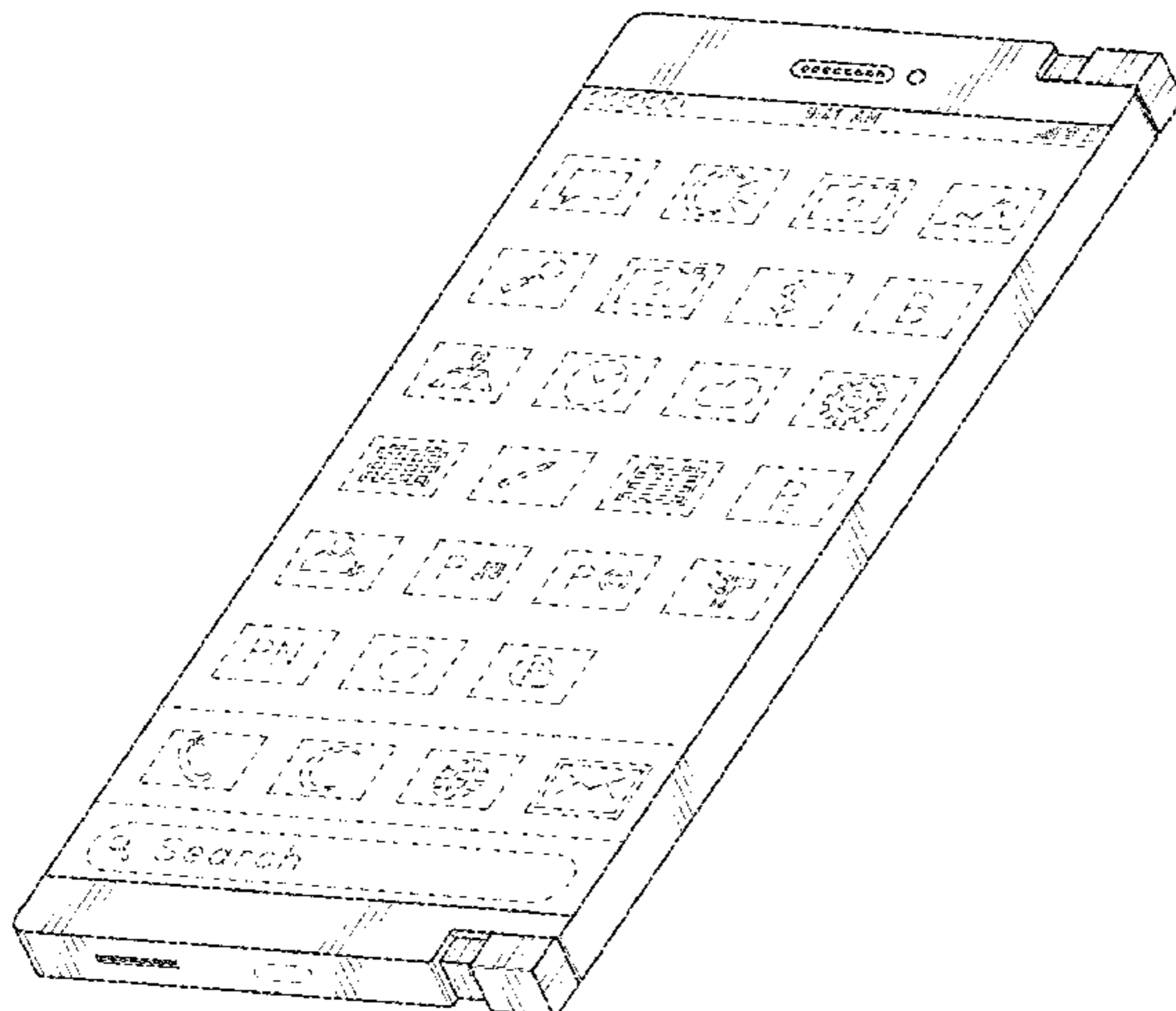

Broken lines, showing graphical user interface elements on a display screen and a charging port, represent environmental matter and design portions that form no part of the claimed design.

**1 Claim, 26 Drawing Sheets**

**Related U.S. Application Data**

which is a division of application No. 29/706,209, filed on Sep. 18, 2019, now Pat. No. Des. 918,898.

(58) **Field of Classification Search**

USPC ..... D14/138 AA, 496, 203; D21/330, 324, D21/329

CPC .... G06F 1/1652; G06F 1/1616; G06F 1/1643; G06F 1/1647; H04M 1/0268; H04M 1/0235; G09F 9/301; H01R 24/68

See application file for complete search history.

(56)

**References Cited**

U.S. PATENT DOCUMENTS

D787,467	S *	5/2017	Xu .....	D14/138	C
D788,773	S *	6/2017	Seo .....	D14/345	
D788,774	S *	6/2017	Seo .....	D14/345	
D851,054	S *	6/2019	Nalbandian .....	D14/138	G
D870,690	S *	12/2019	Xiao .....	D14/138	R
D896,198	S *	9/2020	Nalbandian .....	D14/138	G
10,831,244	B1 *	11/2020	DeMaio .....	G06F 1/1656	
D918,898	S *	5/2021	DeMaio .....	D14/341	
2015/0316959	A1 *	11/2015	Senatori .....	G06F 1/1618	
				345/169	
2015/0378397	A1 *	12/2015	Park .....	G06F 1/1652	
				361/679.27	
2021/0081008	A1 *	3/2021	DeMaio .....	G06F 1/1656	
2021/0173447	A1 *	6/2021	Ku .....	G06F 1/1643	
2021/0216106	A1 *	7/2021	Soh .....	G09F 9/301	

\* cited by examiner

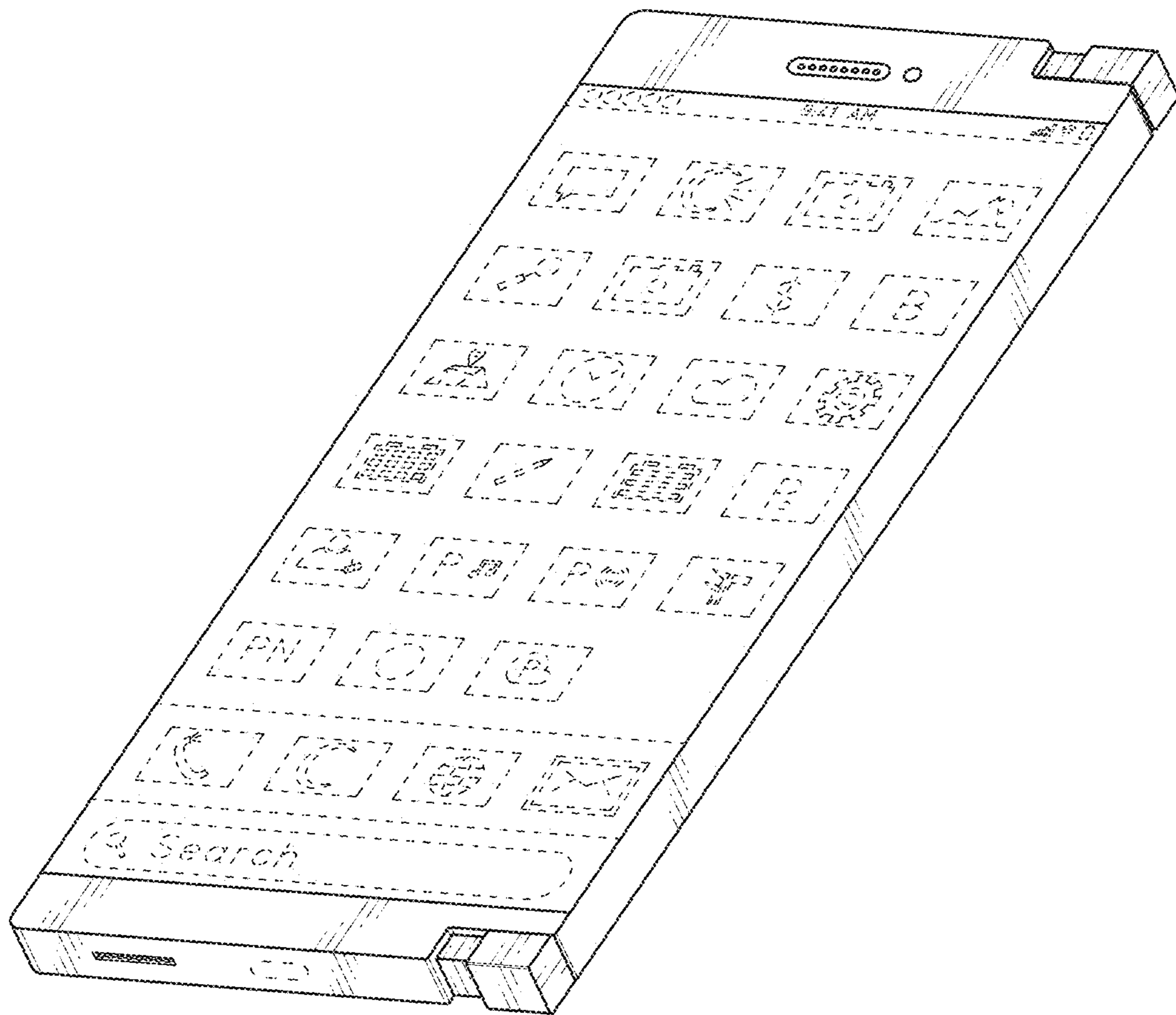

FIG. 1

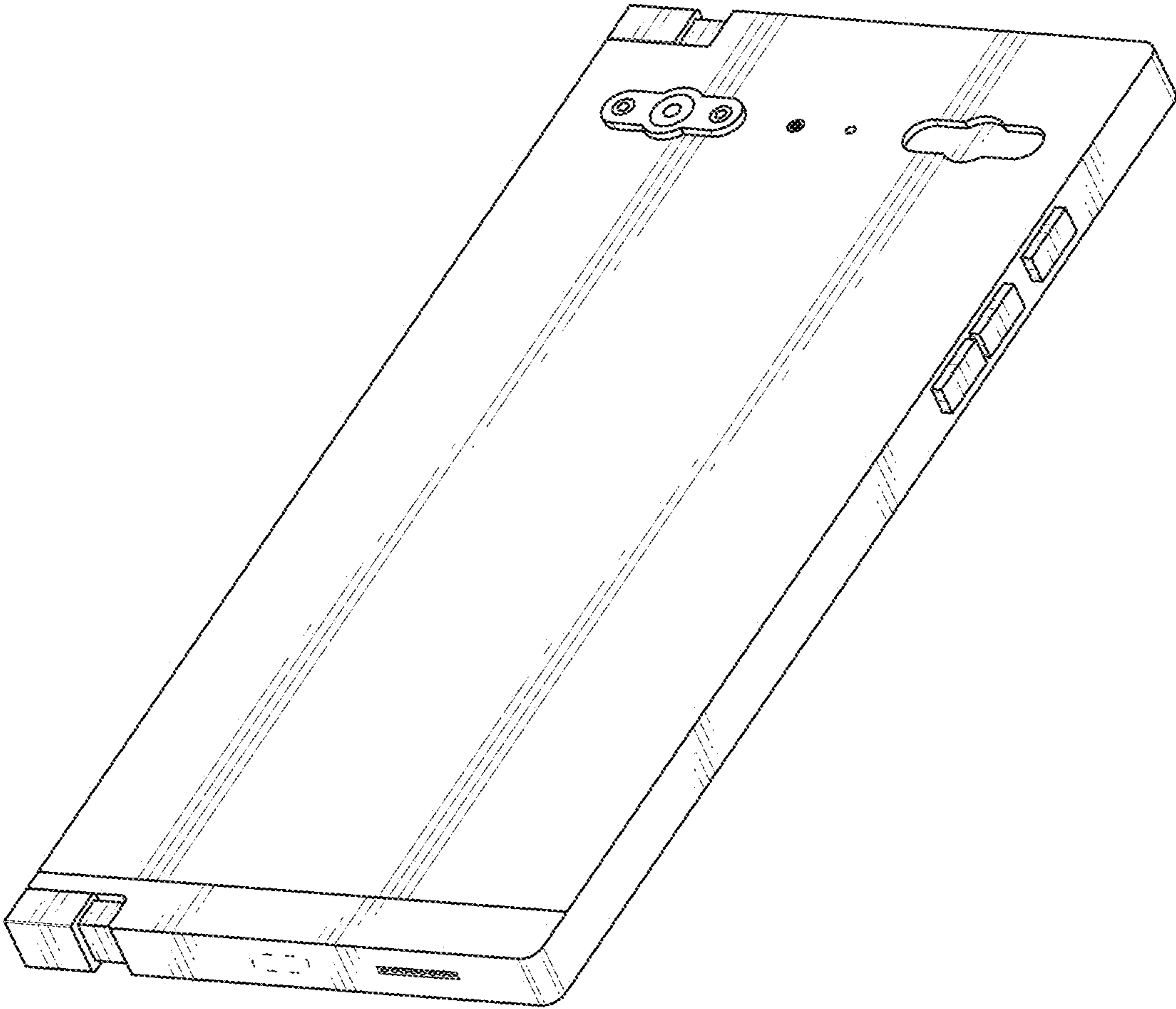

FIG. 2

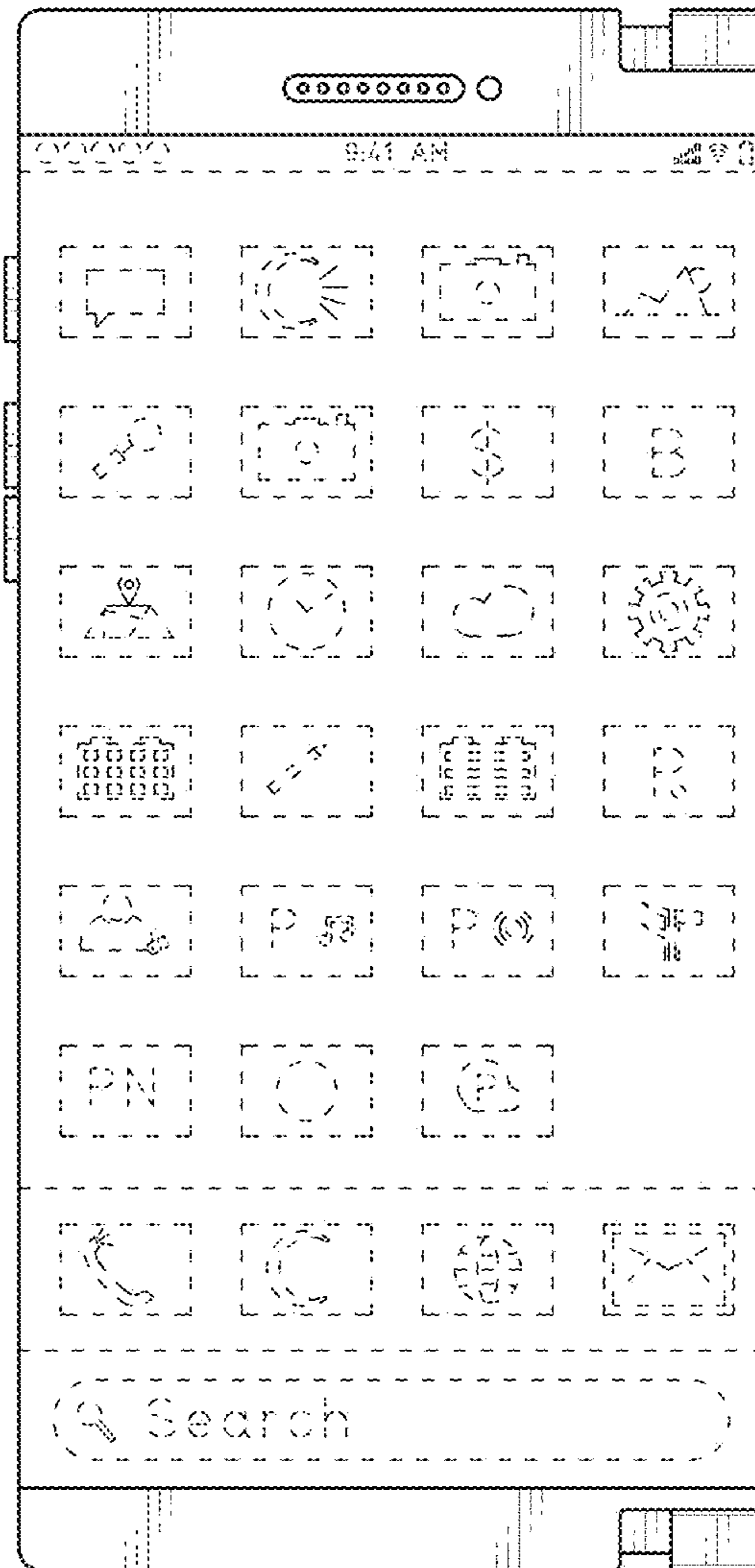

FIG. 3

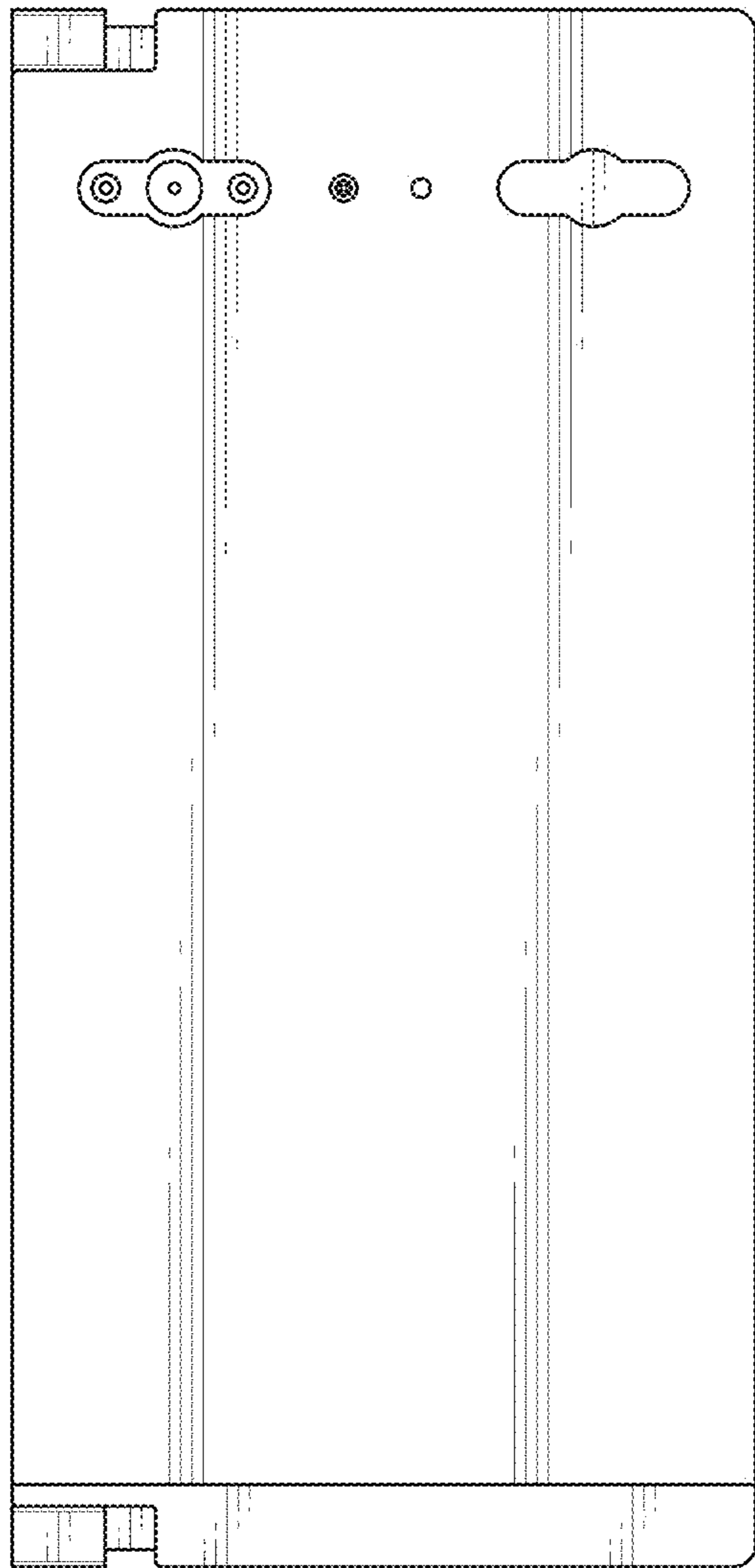

FIG. 4

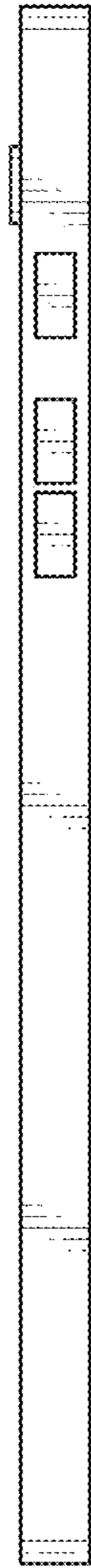

FIG. 5



FIG. 6





FIG. 7



FIG. 8

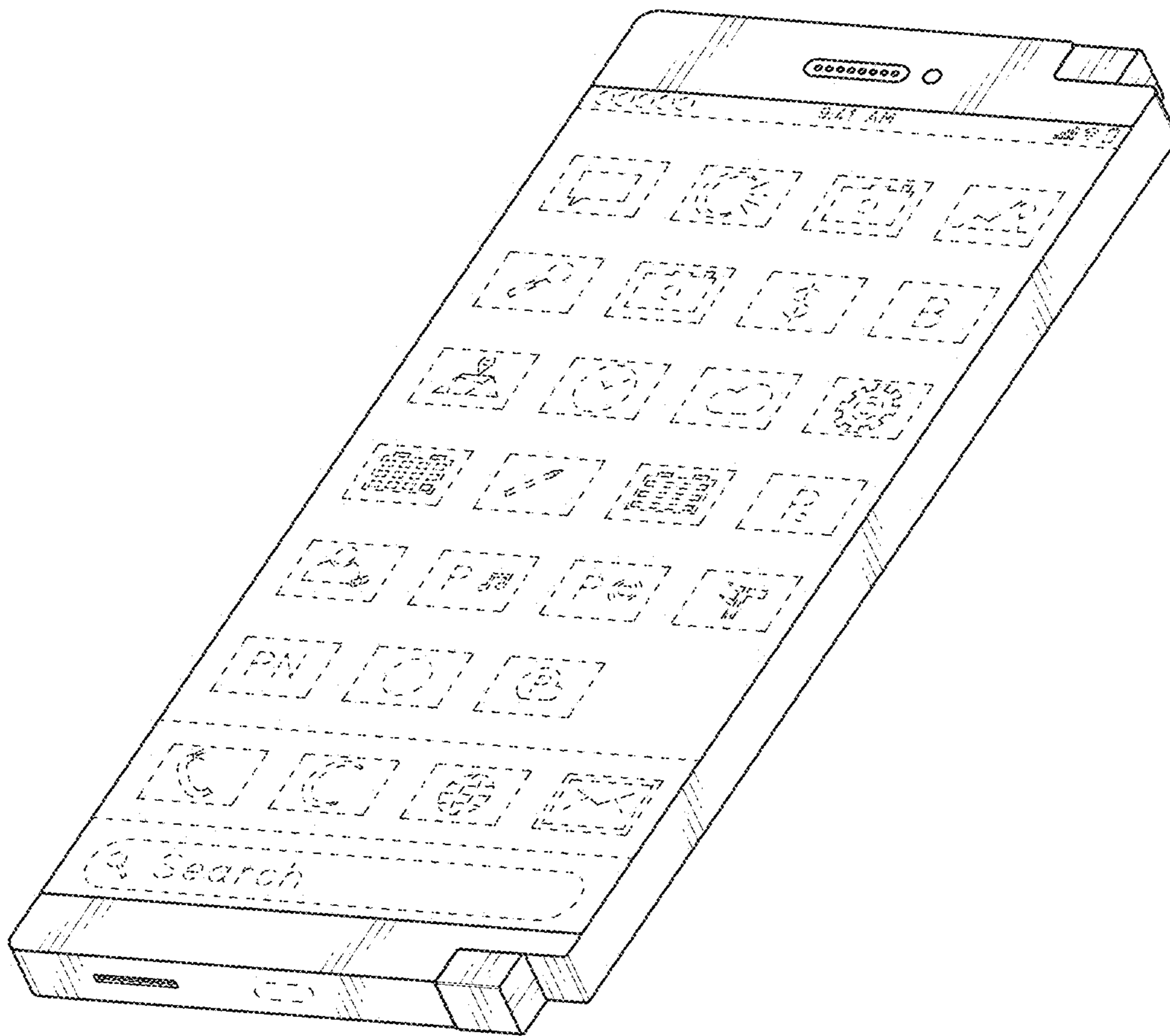

FIG. 9

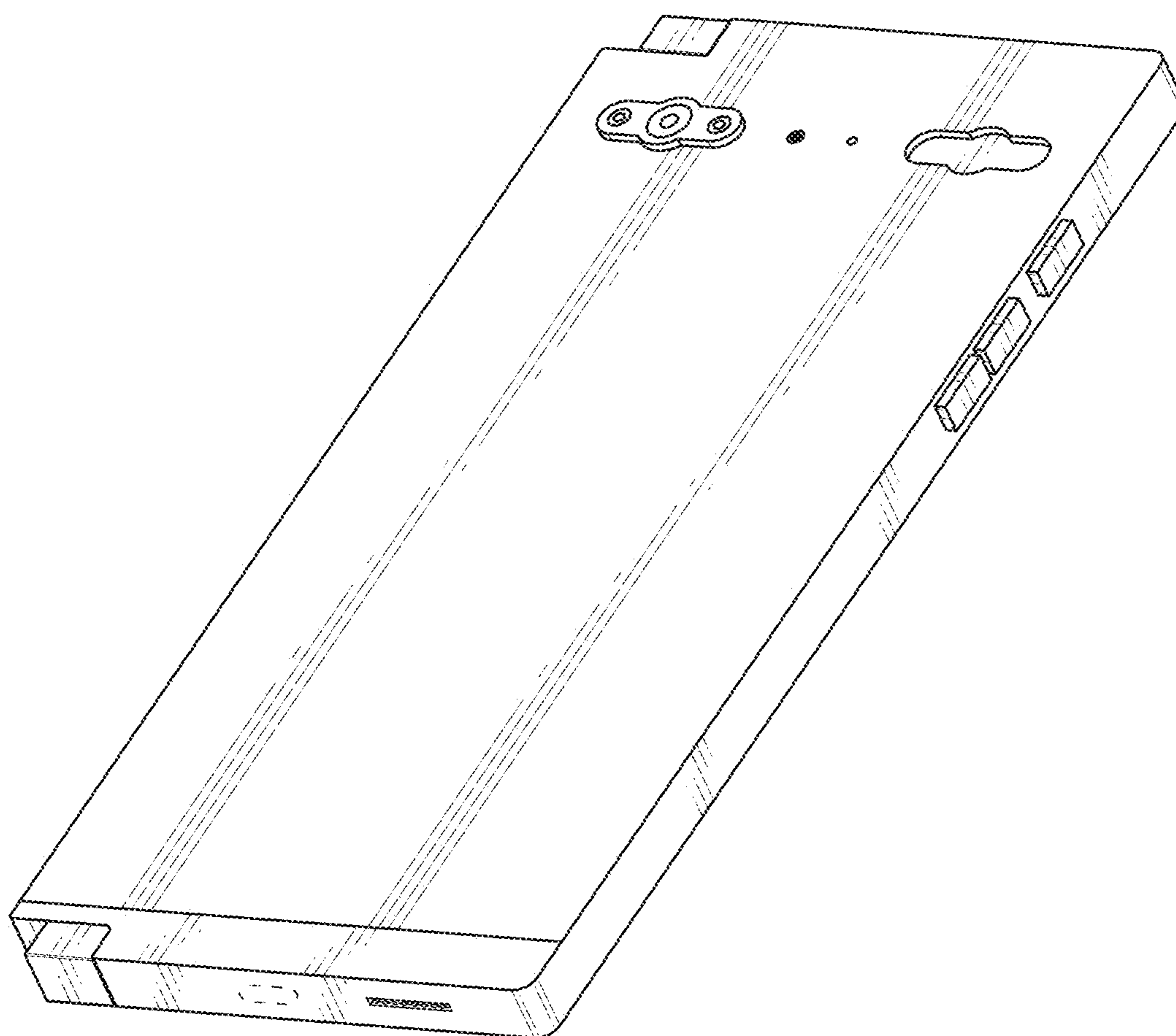

FIG. 10

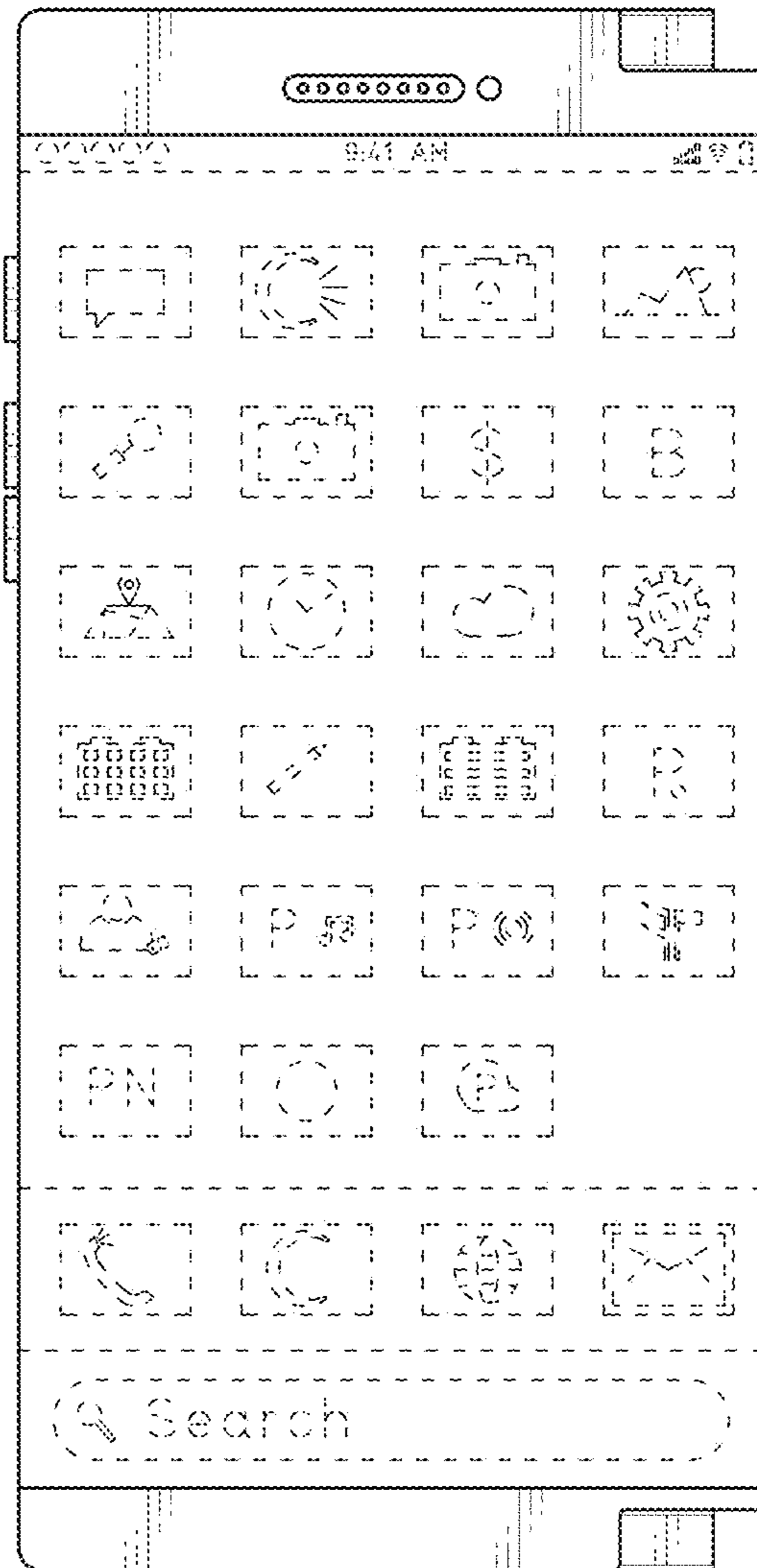

FIG. 11

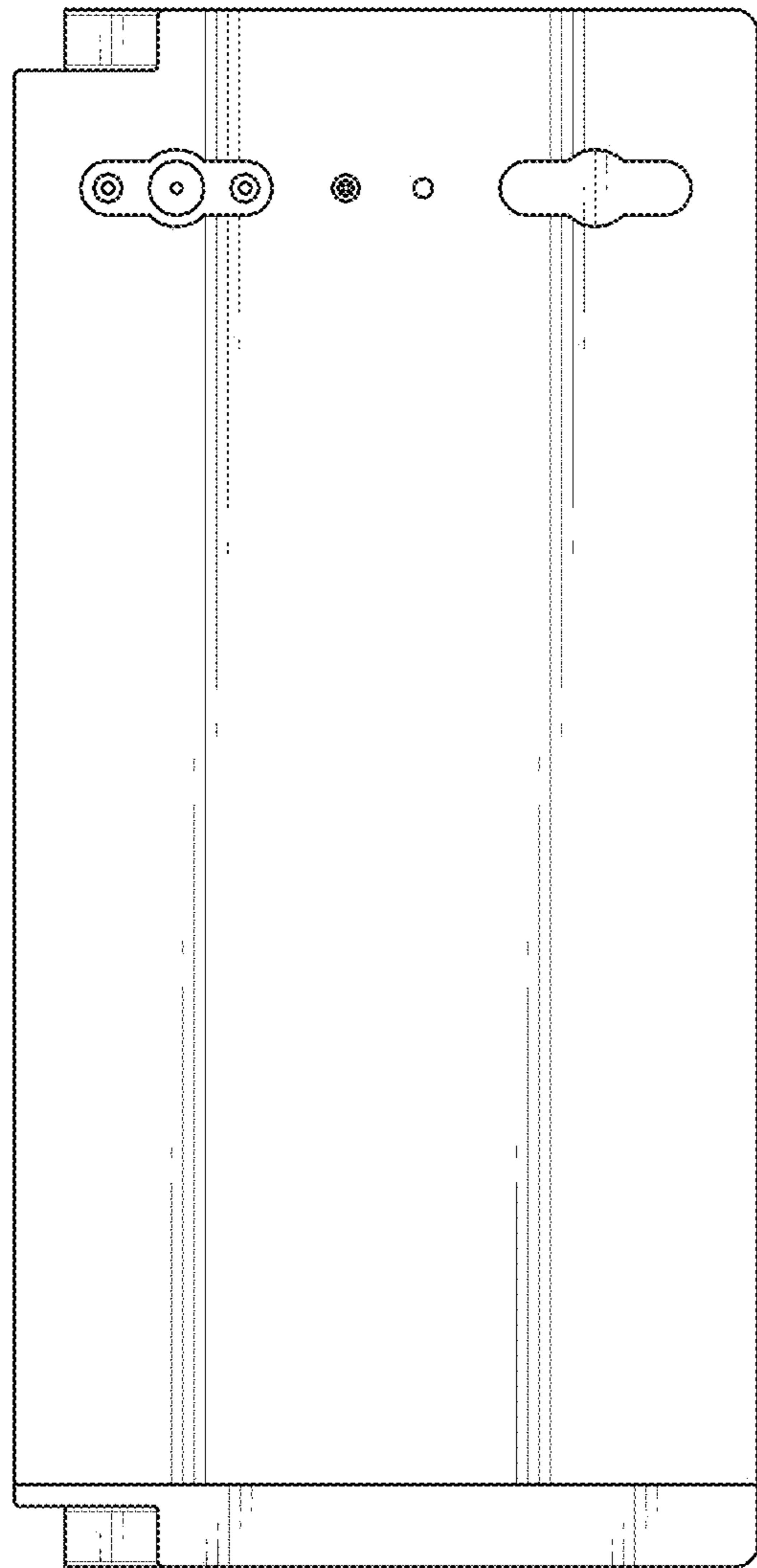

FIG. 12

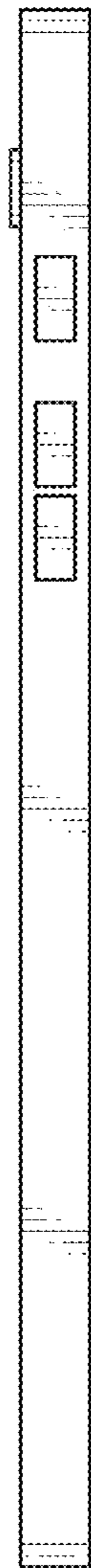

FIG. 13

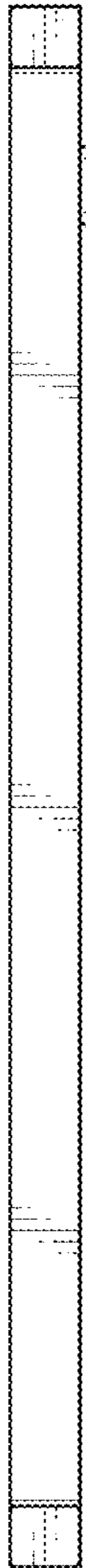

FIG. 14



FIG. 15



FIG. 16



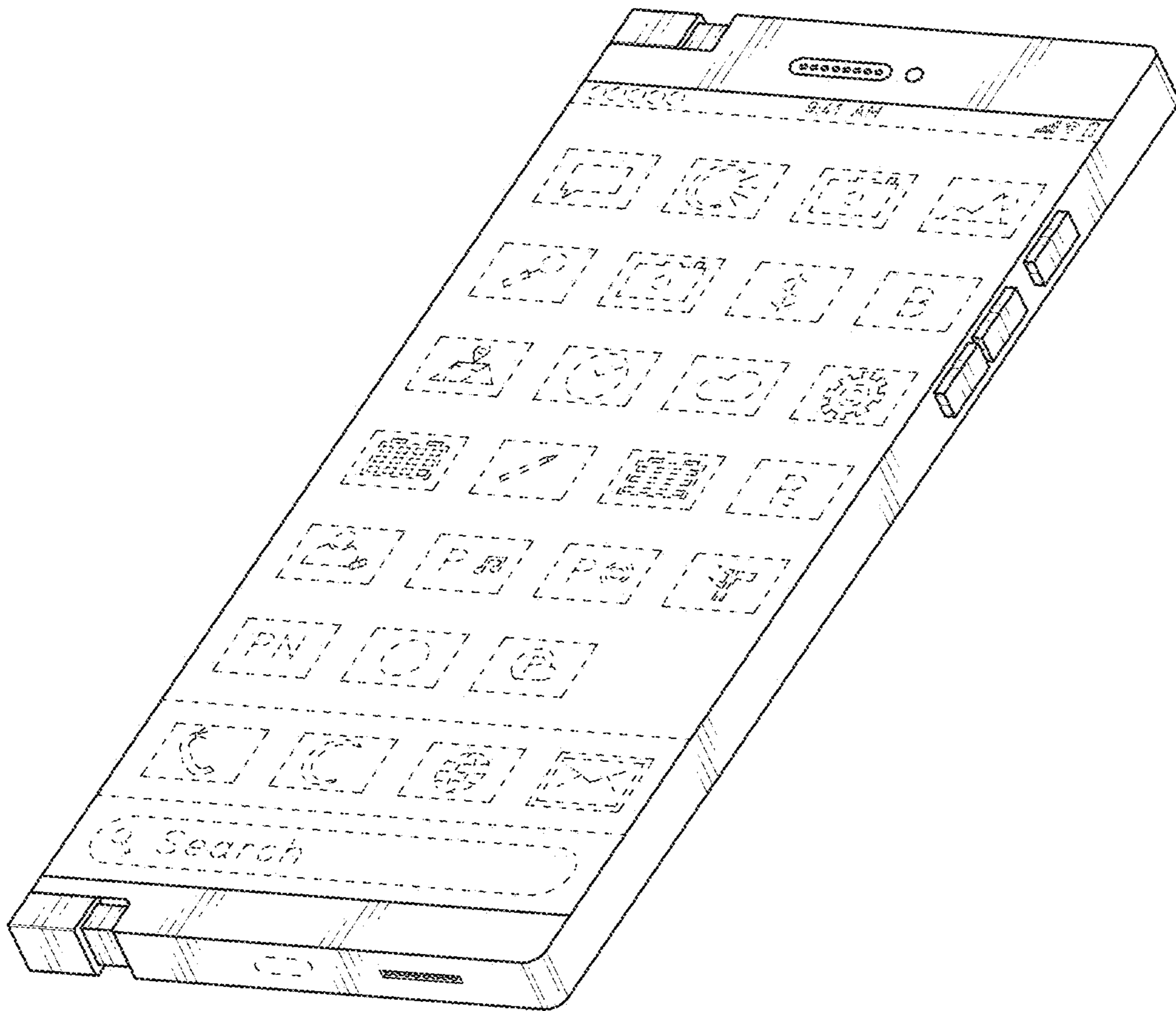

FIG. 17

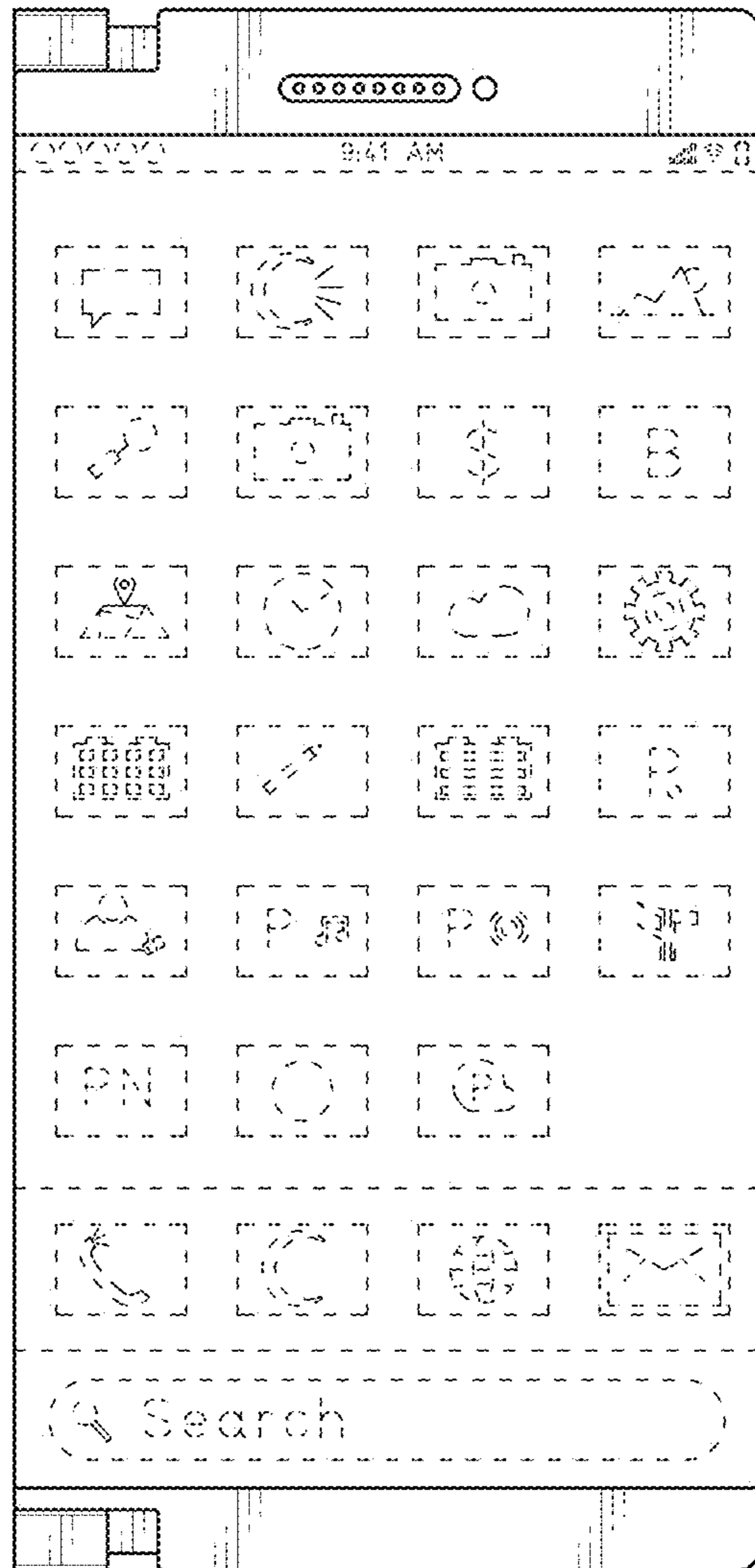

FIG. 18

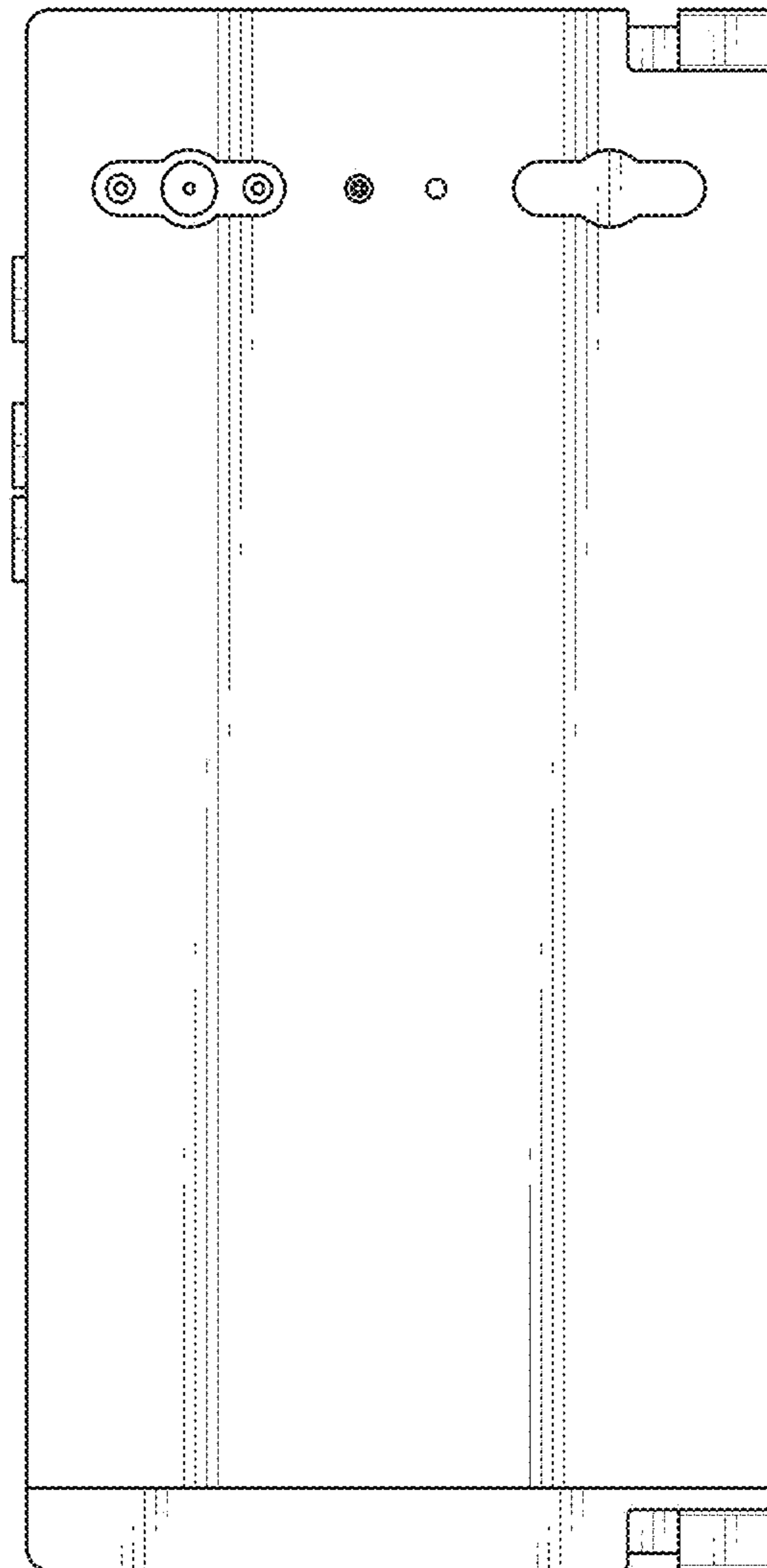

FIG. 19



FIG. 20

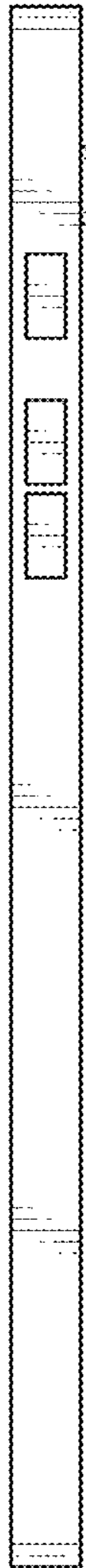

FIG. 21



FIG. 22



FIG. 23

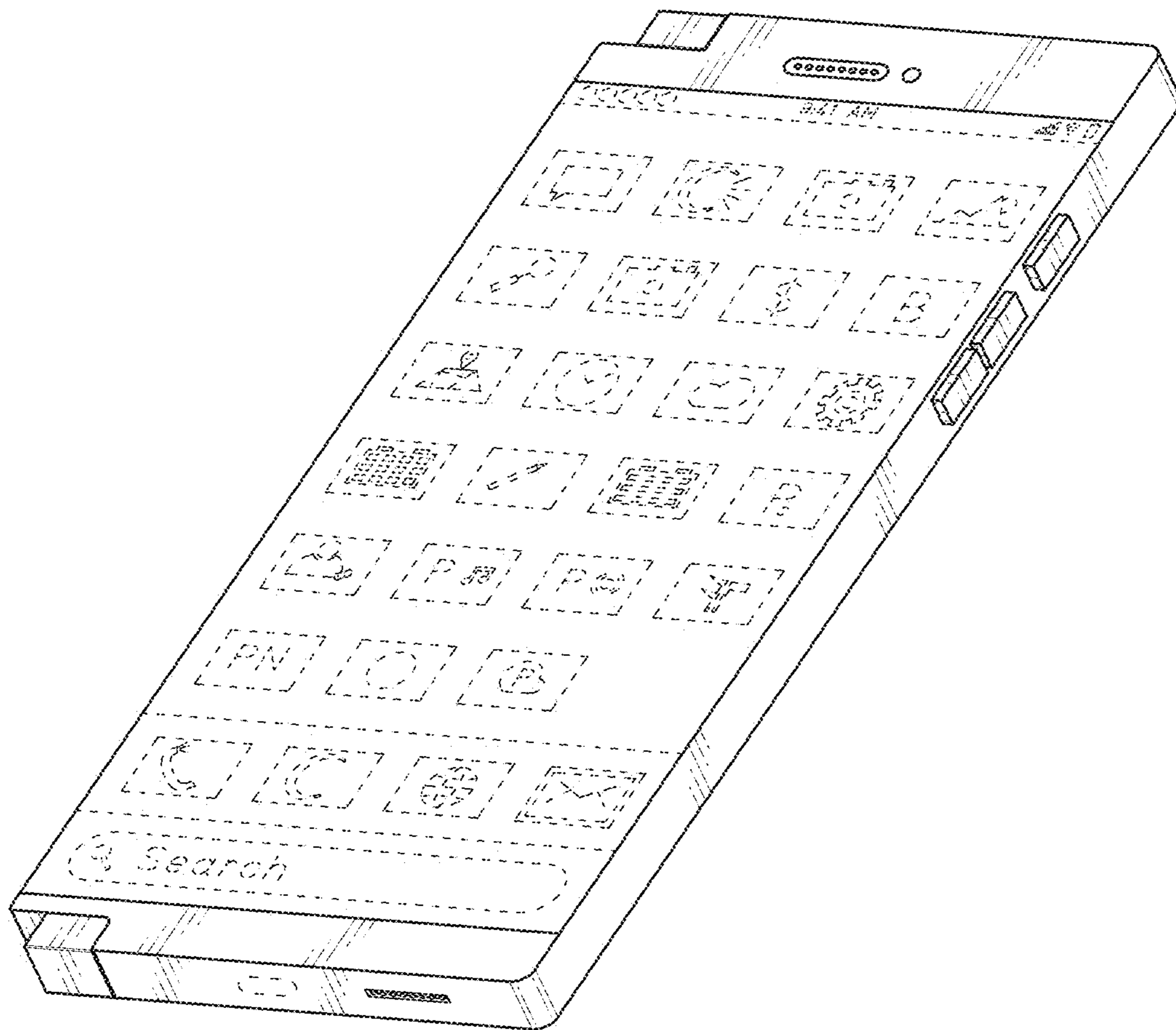

FIG. 24

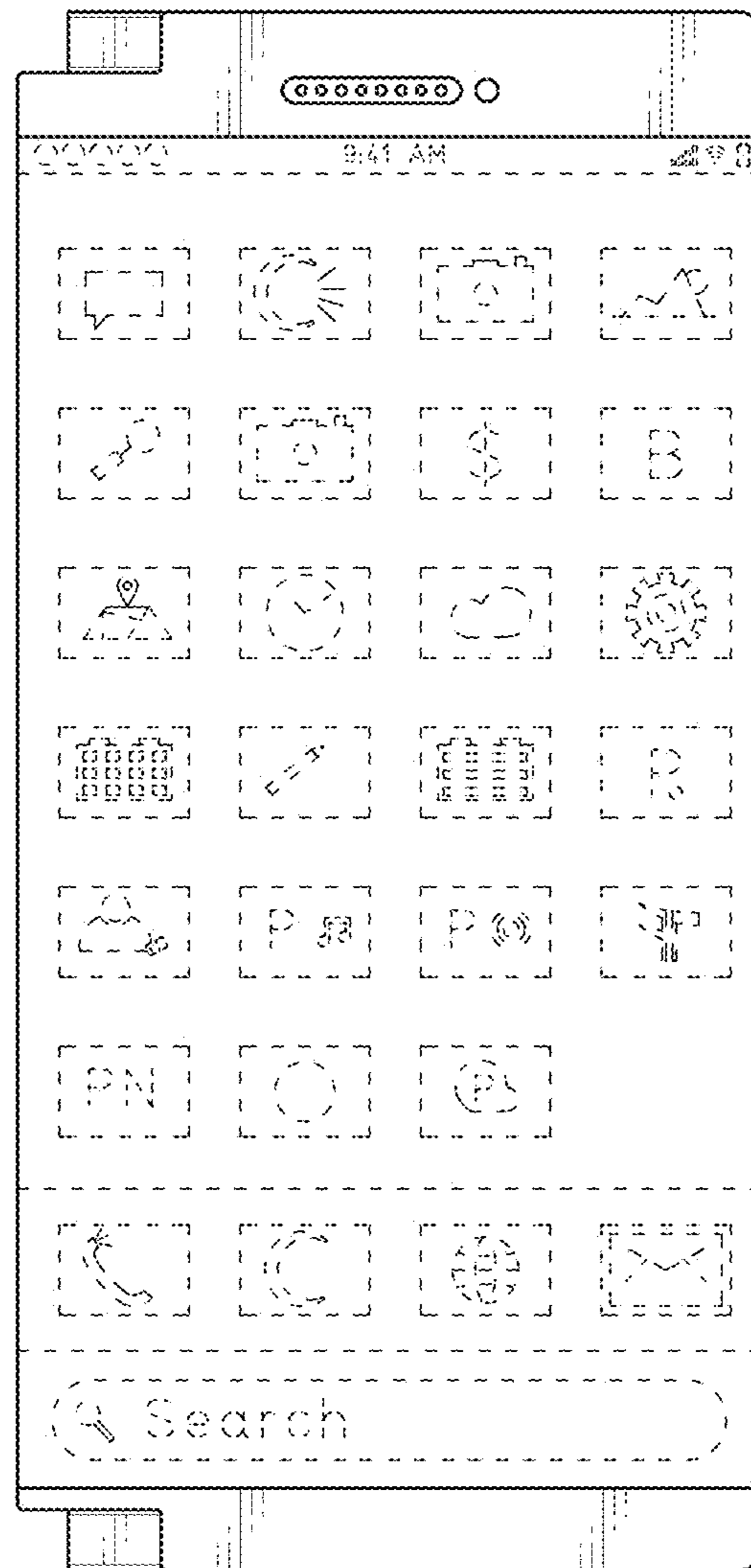

FIG. 25



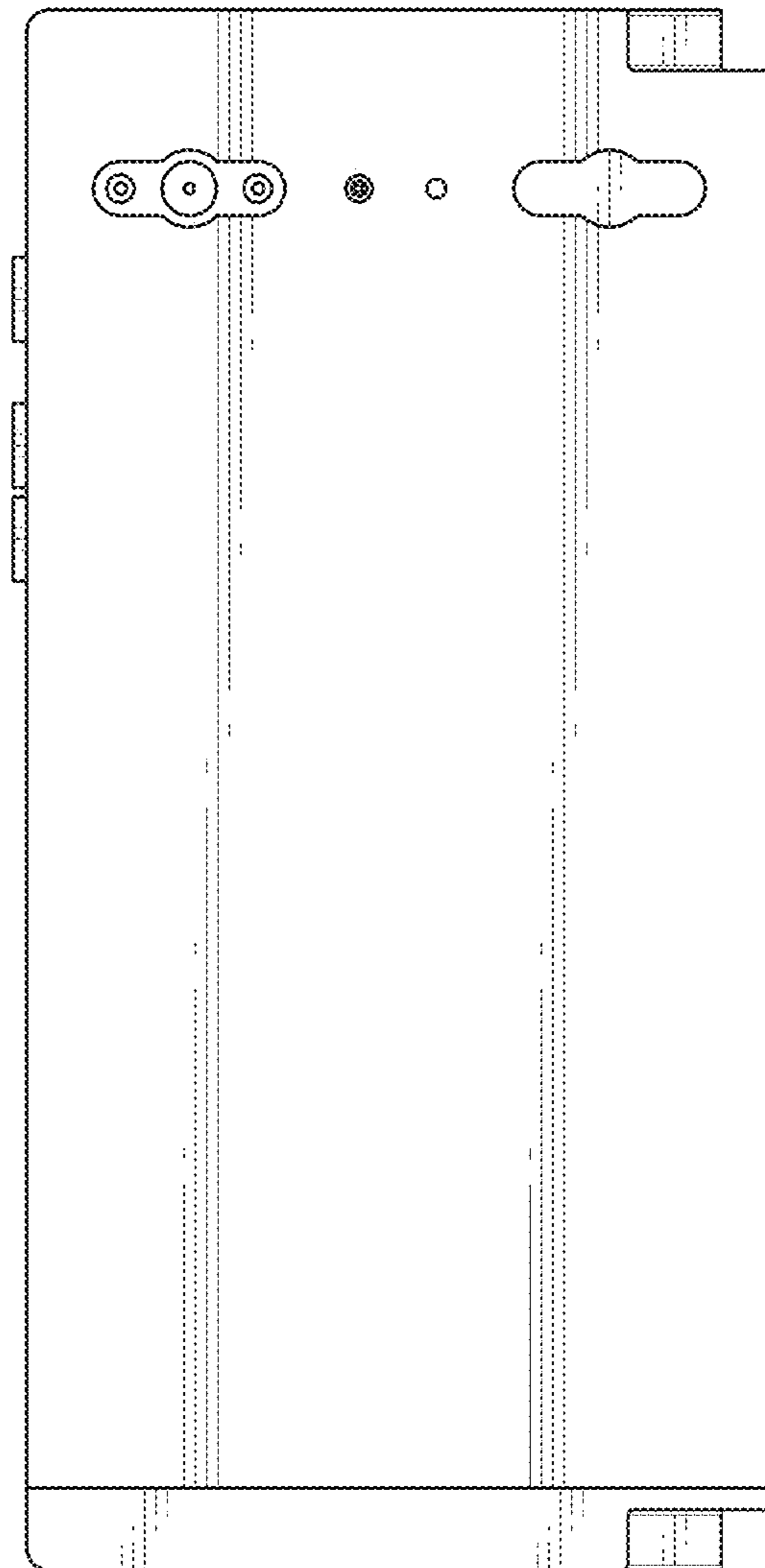

FIG. 26

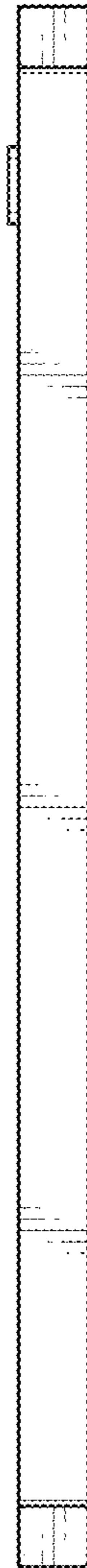

FIG. 27

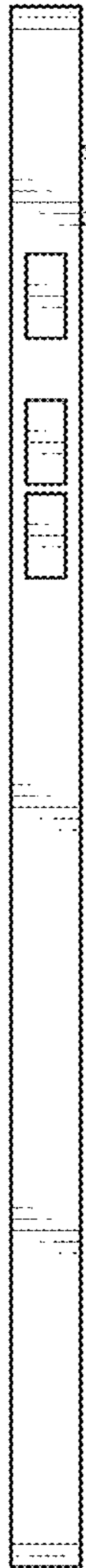

FIG. 28



FIG. 29



FIG. 30