



US00D932919S

(12) **United States Design Patent** (10) **Patent No.:** **US D932,919 S**
Cox et al. (45) **Date of Patent:** **** *Oct. 12, 2021**

(54) **DISPENSING BOTTLE**

(71) Applicant: **Henkel IP & Holding GmbH**,
Duesseldorf (DE)
(72) Inventors: **Peter Cox**, Dublin (IE); **Glenn Doogan**, Dublin (IE); **Peter O'Sullivan**,
Dublin (IE); **Jason Tilk**, Cleveland
Heights, OH (US); **Maynard Payumo**,
Parma, OH (US)
(73) Assignee: **Henkel IP & Holding GmbH**,
Duesseldorf (DE)

(*) Notice: This patent is subject to a terminal disclaimer.

(**) Term: **15 Years**

(21) Appl. No.: **29/718,454**

(22) Filed: **Dec. 24, 2019**

(51) **LOC (13) Cl.** **09-01**

(52) **U.S. Cl.**
USPC **D9/563; D9/550; D9/575**

(58) **Field of Classification Search**
USPC D9/500, 516, 521, 530, 536, 542, 544,
D9/549, 550, 556, 558, 559, 562, 563,
(Continued)

(56) **References Cited**

U.S. PATENT DOCUMENTS

D184,593 S 11/1876 Curtice
1,602,391 A 10/1926 Creaver
(Continued)

FOREIGN PATENT DOCUMENTS

CN 303205468 * 5/2015
CN 305193695 * 6/2019
(Continued)

OTHER PUBLICATIONS

Loctite, Jul. 15, 2020, Loctite Youtube Page Video Post, URL:https://
www.youtube.com/watch?v=2J8vesV5fRU (Year: 2020).*
(Continued)

Primary Examiner — Brett Miller
Assistant Examiner — Rani J Abdallah
(74) *Attorney, Agent, or Firm* — Steven C. Bauman

(57) **CLAIM**

The ornamental design for a dispensing bottle, as shown and described.

DESCRIPTION

FIG. 1 is a front, top, and right side perspective view of a yellow dispensing bottle showing our new design, where the entirety of the claimed surfaces appear at a wavelength in the range 570-590 nm on the visible wavelength spectrum;
FIG. 2 is a front view thereof;
FIG. 3 is a rear view thereof;
FIG. 4 is a left view thereof;
FIG. 5 is a right view thereof;
FIG. 6 is a top view thereof;
FIG. 7 is a bottom view thereof;
FIG. 8 is a front, top, and right side perspective view of a yellow dispensing bottle showing our new design according to another embodiment, where the entirety of the claimed surfaces appear at a wavelength in the range 570-590 nm on the visible wavelength spectrum;
FIG. 9 is a front view thereof;
FIG. 10 is a rear view thereof;
FIG. 11 is a left view thereof;
FIG. 12 is a right view thereof;
FIG. 13 is a top view thereof; and,
FIG. 14 is a bottom view thereof.
The broken lines depict environment and form no part of the claimed design.

1 Claim, 10 Drawing Sheets

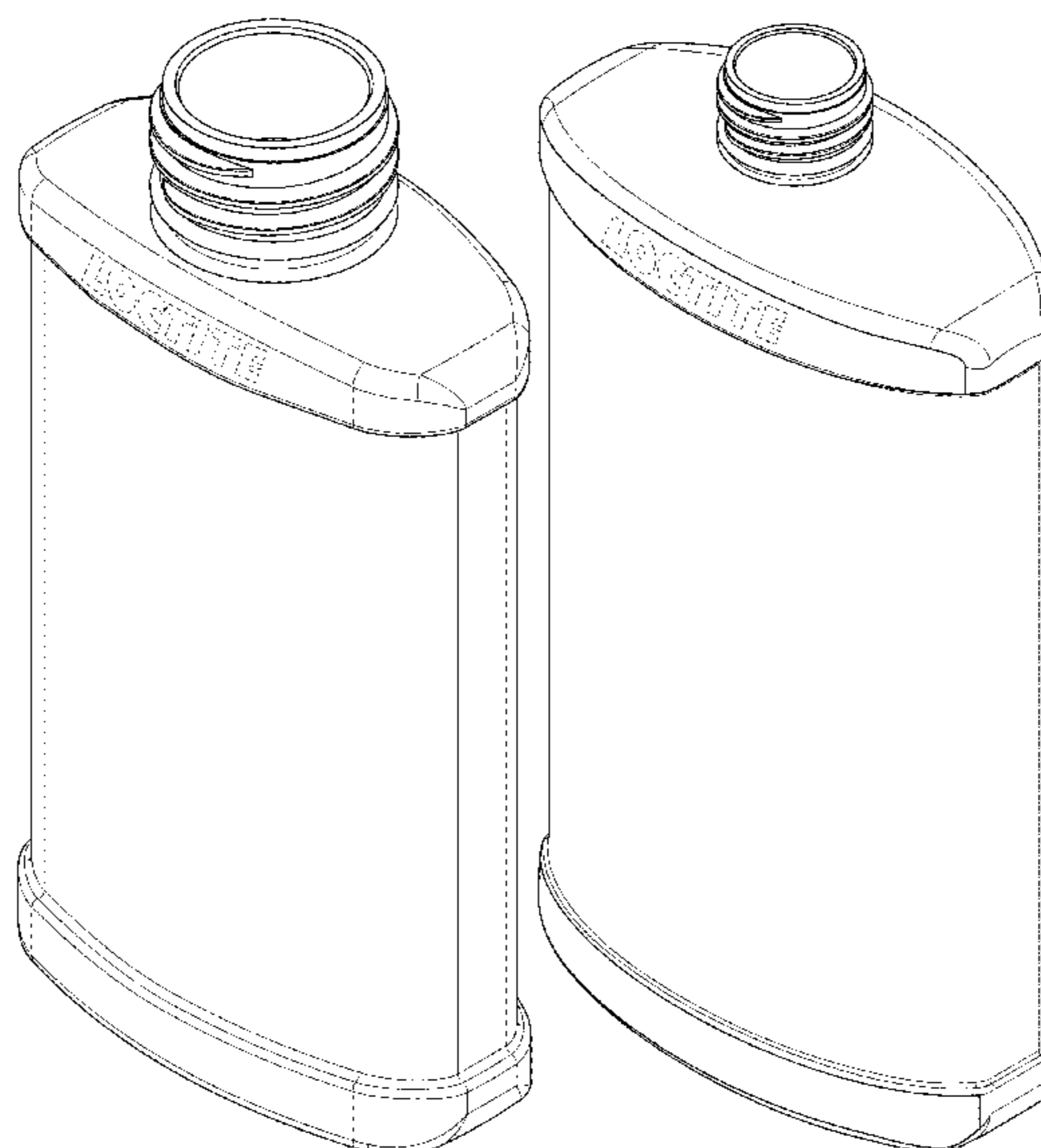

(58) **Field of Classification Search**

USPC D9/565, 572, 573, 574,575, 552, 560,
 D9/571, 557; D4/114; D7/590
 CPC B65D 1/0223; B65D 23/102; B65D
 2501/0081; B65D 2501/0036; B65D
 79/005; B65D 1/44; C08L 33/08; A61J
 1/03; A61J 1/00

See application file for complete search history.

6,129,802	A	10/2000	Key	
6,536,977	B1	3/2003	Hammel	
D505,078	S	5/2005	Fischer et al.	
6,913,405	B2	7/2005	Fischer et al.	
6,997,337	B1	2/2006	Wurster	
D528,429	S	9/2006	Bartel	
D529,814	S *	10/2006	Winkler	D9/563
D533,456	S	12/2006	Schuller et al.	
D614,036	S	4/2010	Gedanke	
D619,471	S *	7/2010	Graunstadt	D9/556
2001/0022291	A1	9/2001	Shimada et al.	
2005/0189314	A1	9/2005	Carbone	
2007/0090083	A1	10/2007	Trude	
2009/0255893	A1	10/2009	Zummo et al.	
2013/0008913	A1	1/2013	Boukoba	
2015/0158620	A1	6/2015	Sekiguchi et al.	
2020/0198826	A1	6/2020	Xoy et al.	

(56) **References Cited**

U.S. PATENT DOCUMENTS

D109,928	S	5/1938	Williams	
D176,975	S	2/1956	Chilton	
D254,773	S *	4/1980	Kretz	D9/542
D260,367	S *	8/1981	Grip	D9/573
D278,515	S *	4/1985	Adams	D9/573
D279,261	S *	6/1985	Blocksom	D9/573
D286,986	S *	12/1986	Rader	D9/573
D290,342	S *	6/1987	Lyons	D9/571
D309,714	S *	8/1990	Biesecker	D9/542
D316,225	S	4/1991	Edstrom et al.	
D319,582	S *	9/1991	Crawford	D9/575
5,156,285	A	10/1992	Zogg et al.	
D333,435	S *	2/1993	Blair	D9/574
D348,613	S *	7/1994	Gonda	D9/574
5,435,451	A	7/1995	Dyer	
D367,010	S *	2/1996	Moore	D9/542
D372,675	S *	8/1996	Pollard	D9/542
D394,211	S	5/1998	Kuzma et al.	

FOREIGN PATENT DOCUMENTS

KR	300423334.0000	*	9/2006	
KR	3020180001616	*	12/2018	

OTHER PUBLICATIONS

New Pocking, Feb. 28, 2020, Henkel website post, URL:https://www.henkel-adhesives.com/uk/en/product/threadlockers/loctite_222.html (Year: 2020).*

* cited by examiner

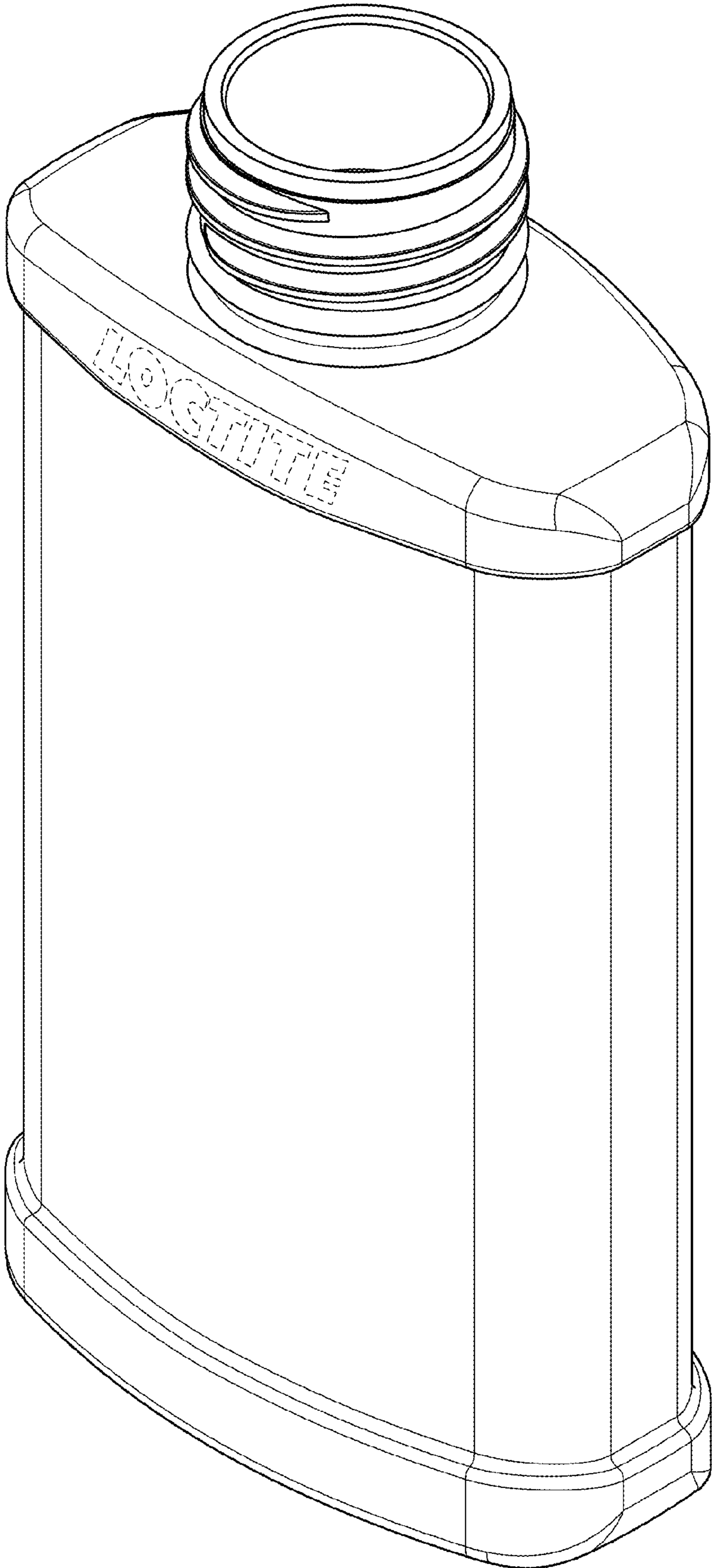

FIG. 1

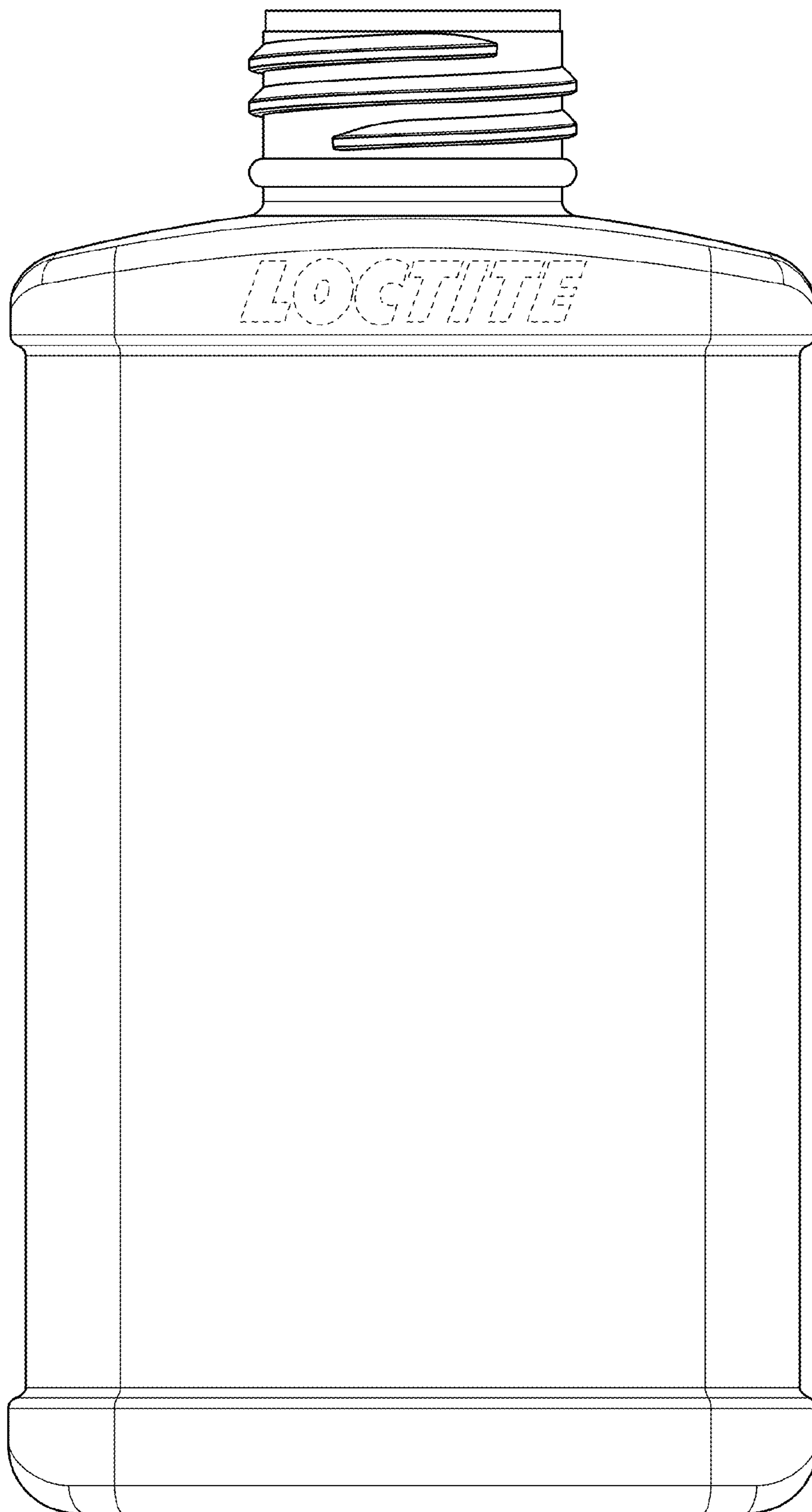

FIG. 2

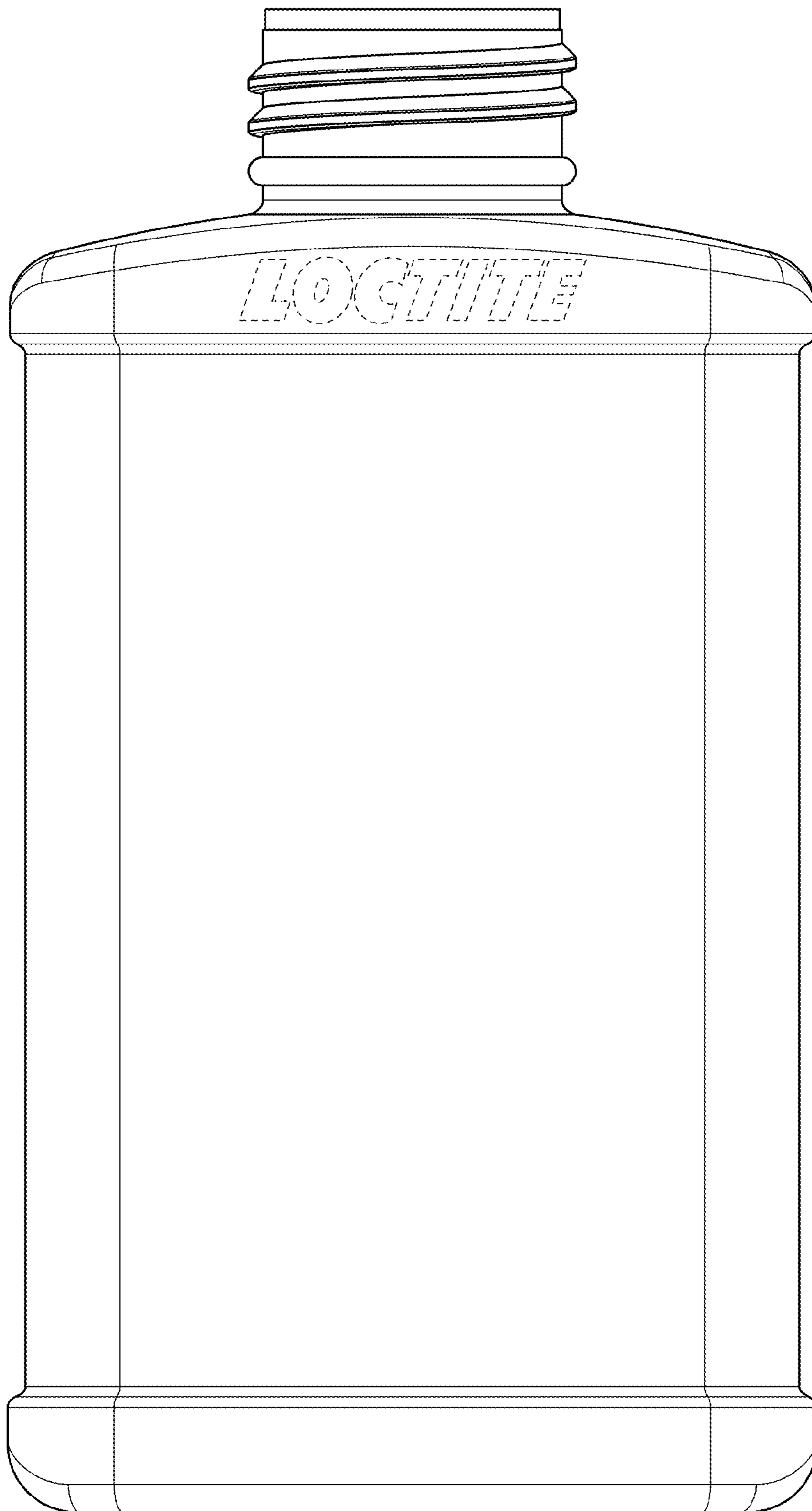

FIG. 3

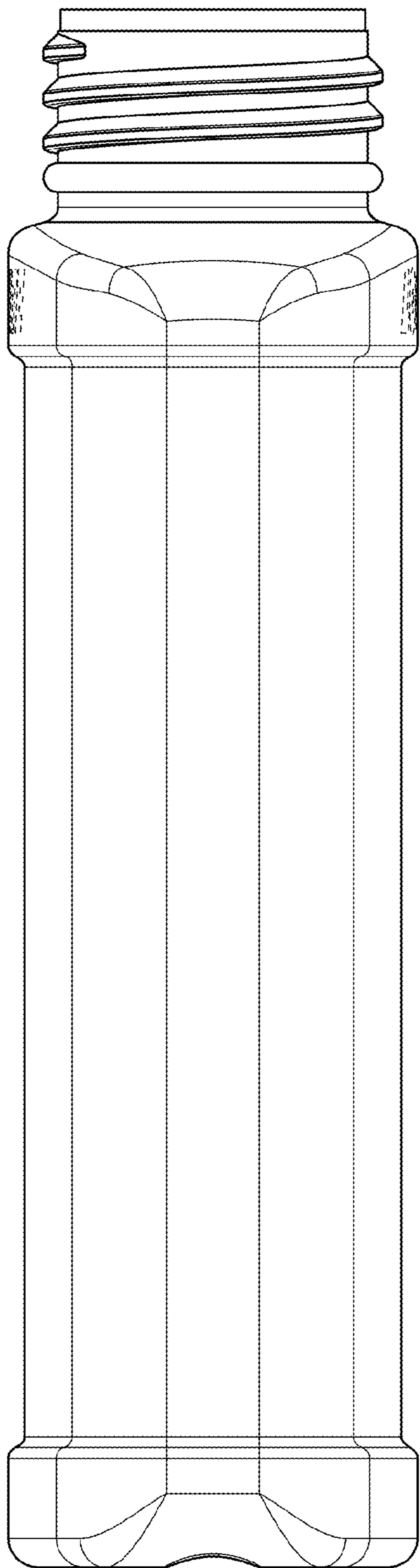

FIG. 4

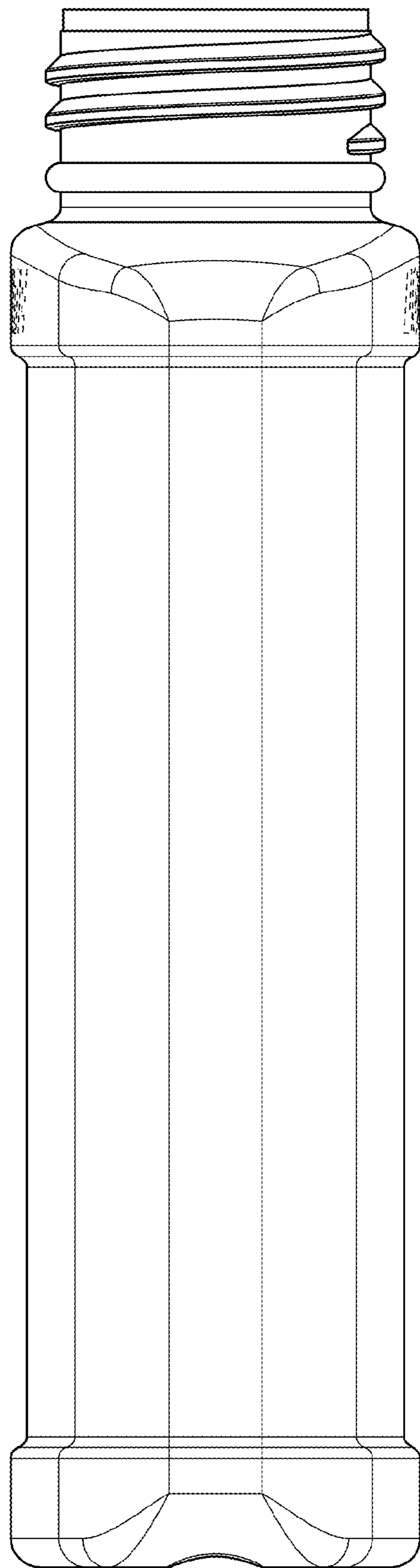

FIG. 5

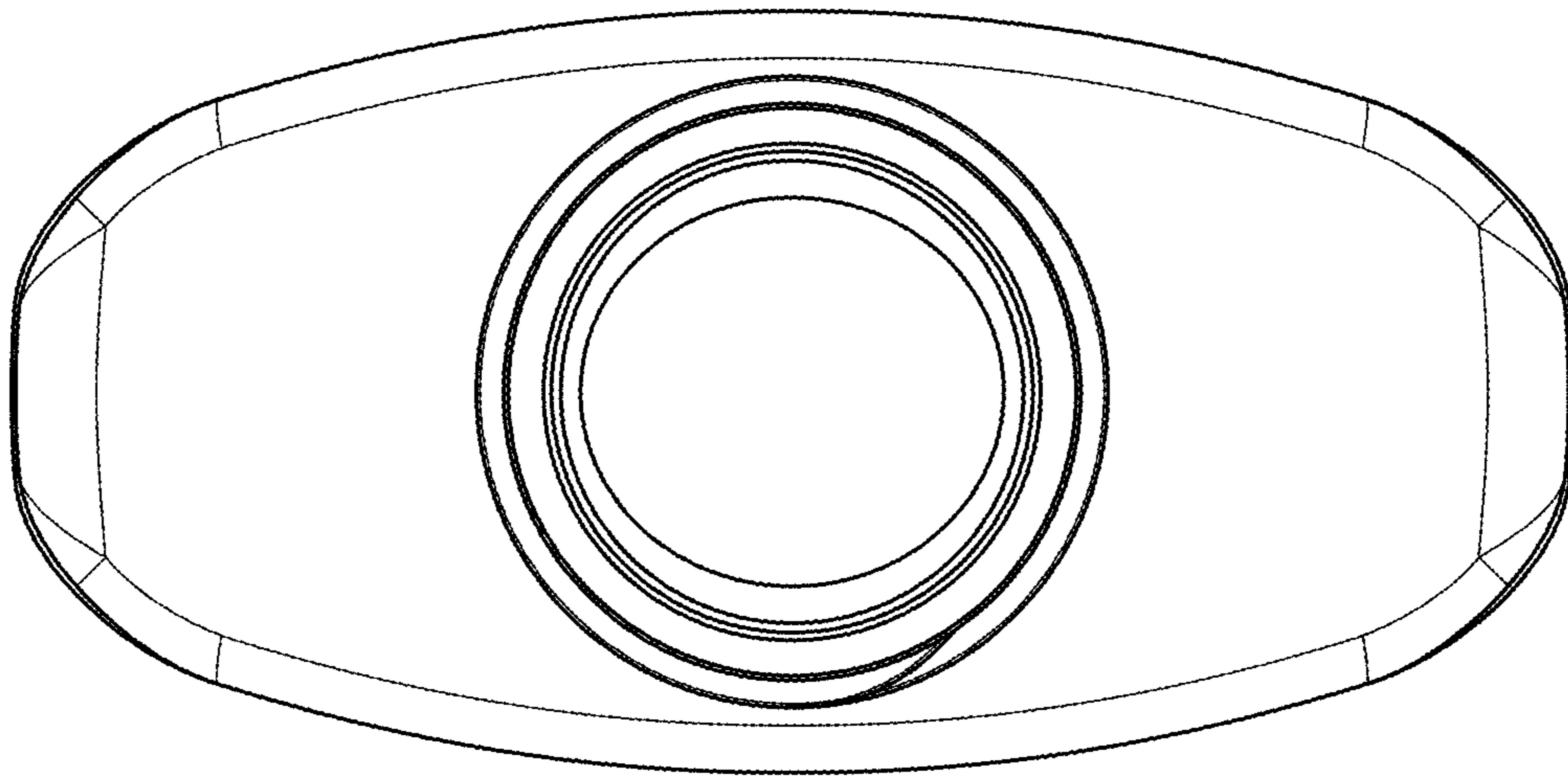

FIG. 6

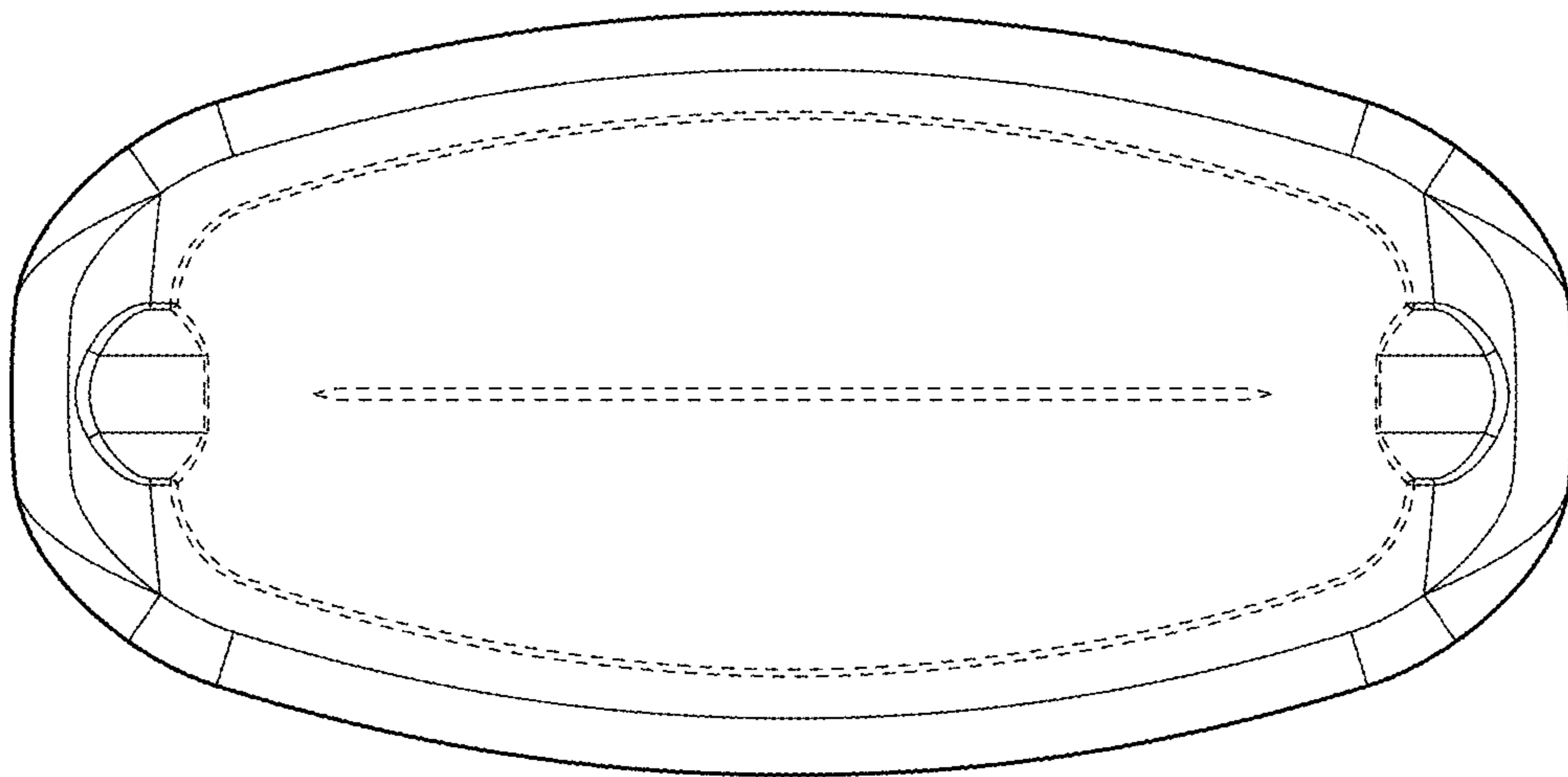

FIG. 7

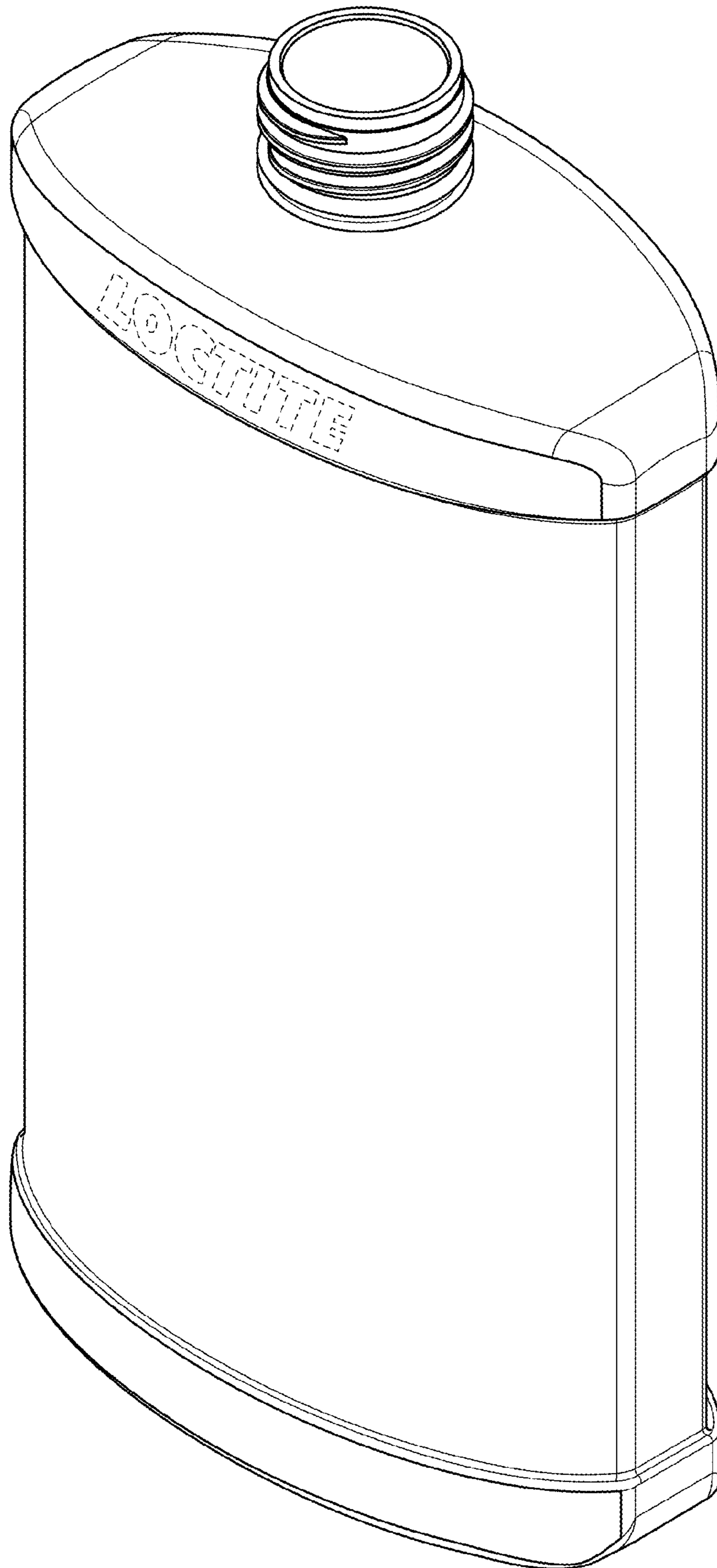

FIG. 8

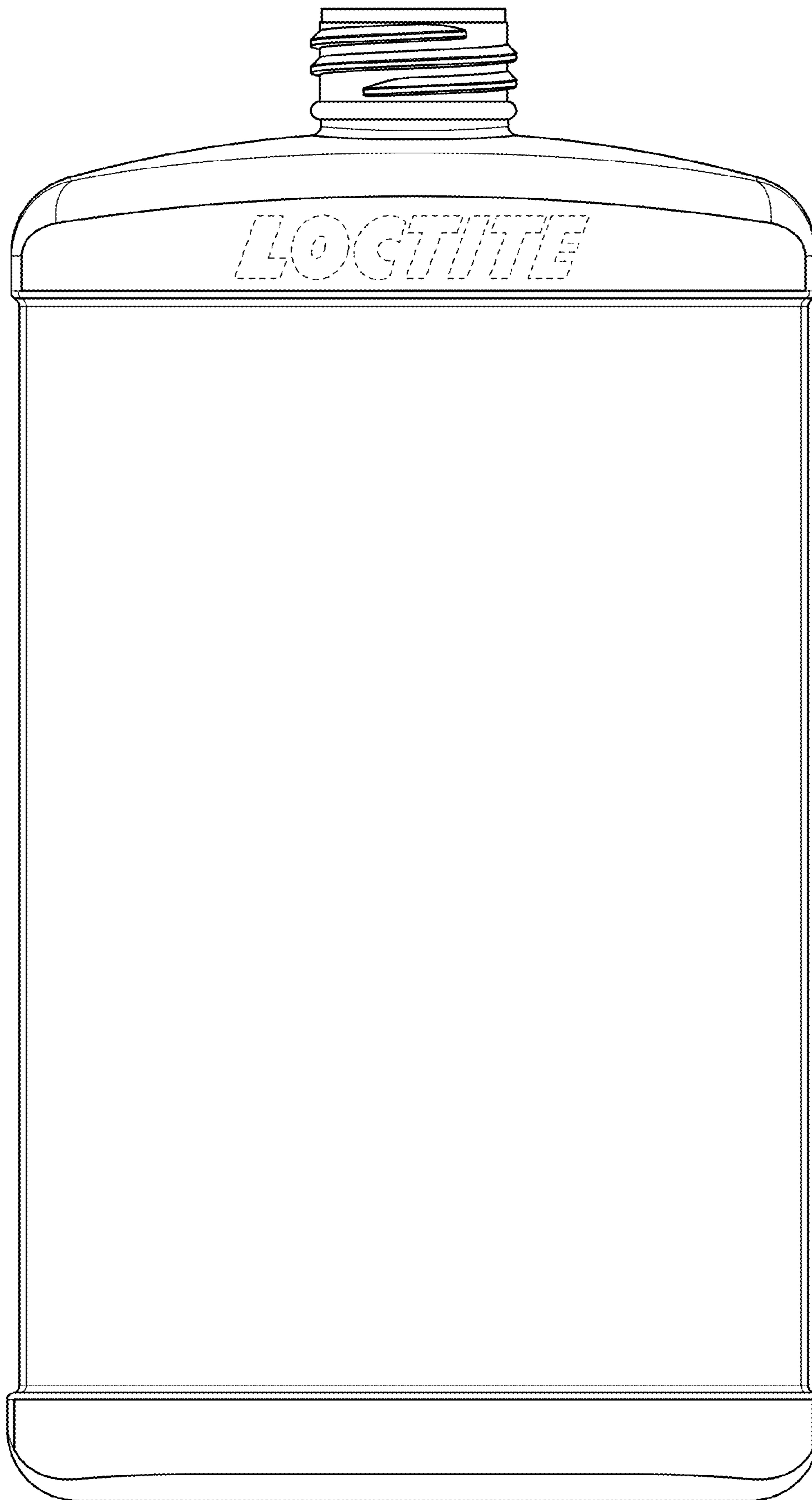

FIG. 9

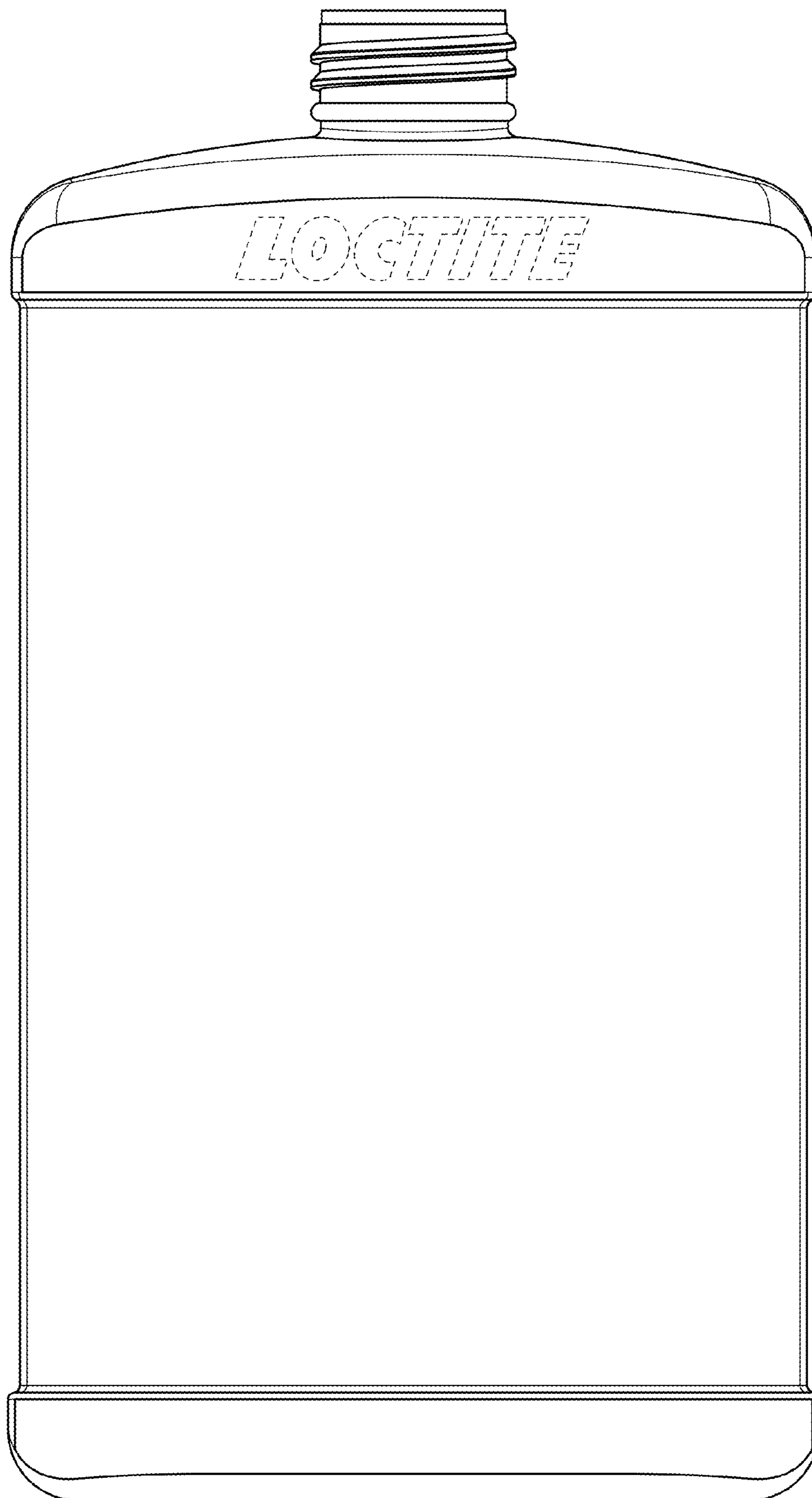

FIG. 10

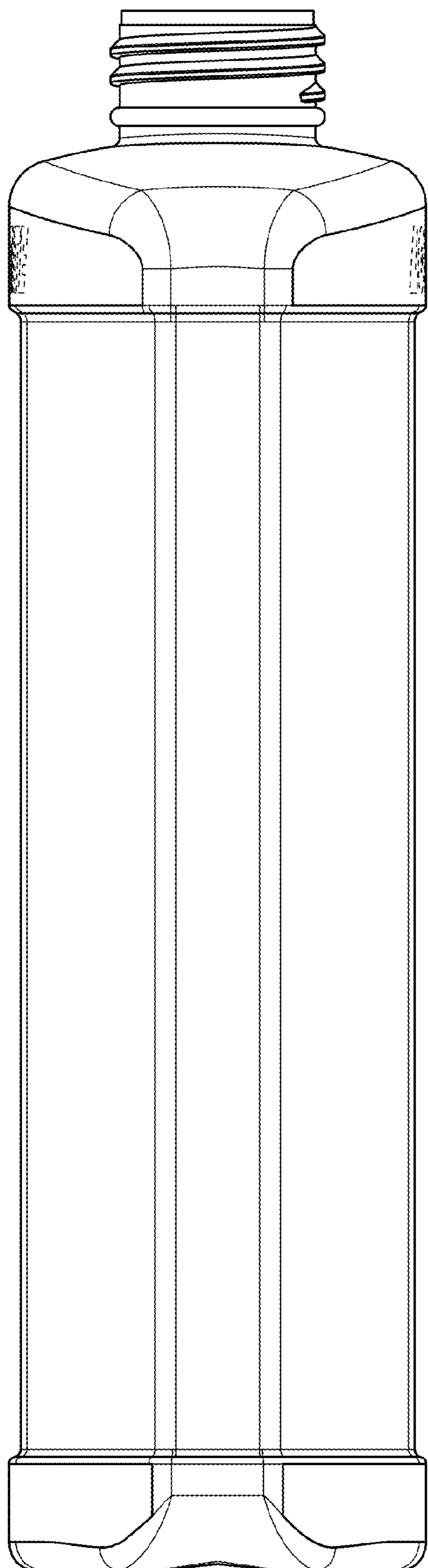

FIG. 11

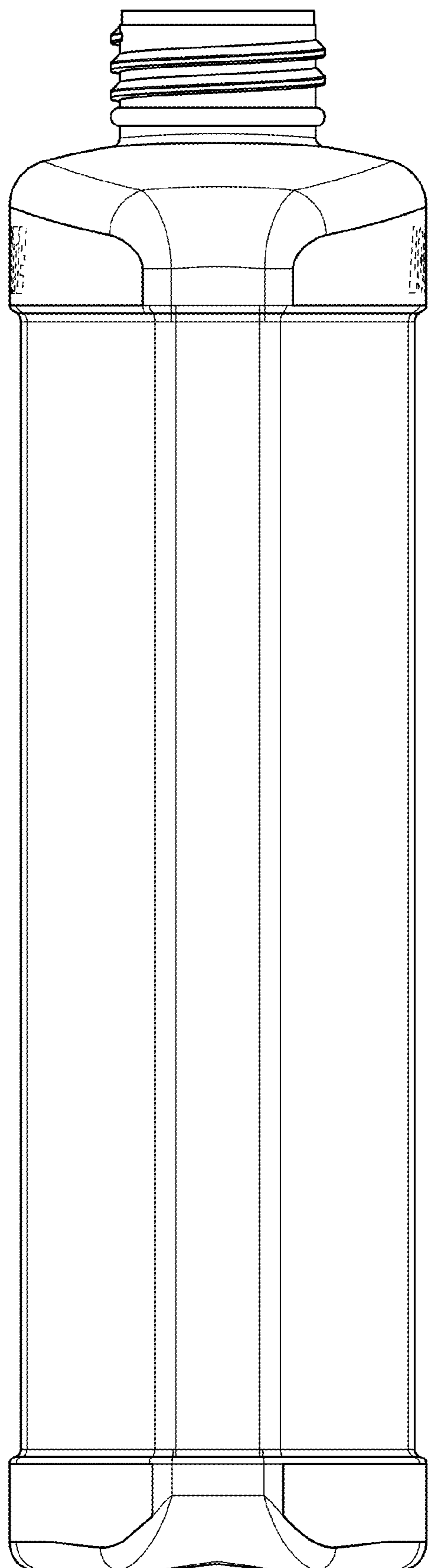

FIG. 12

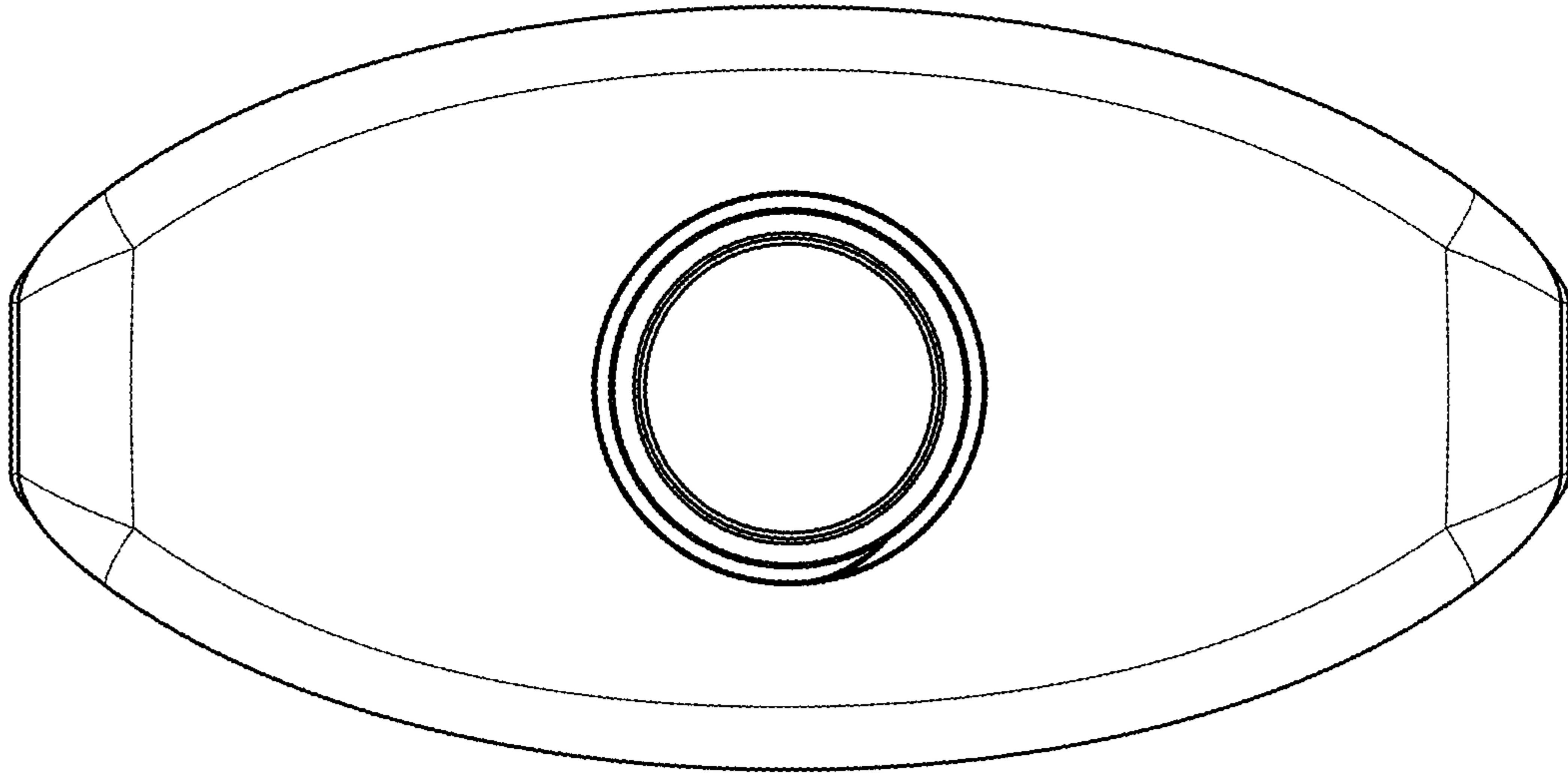

FIG. 13

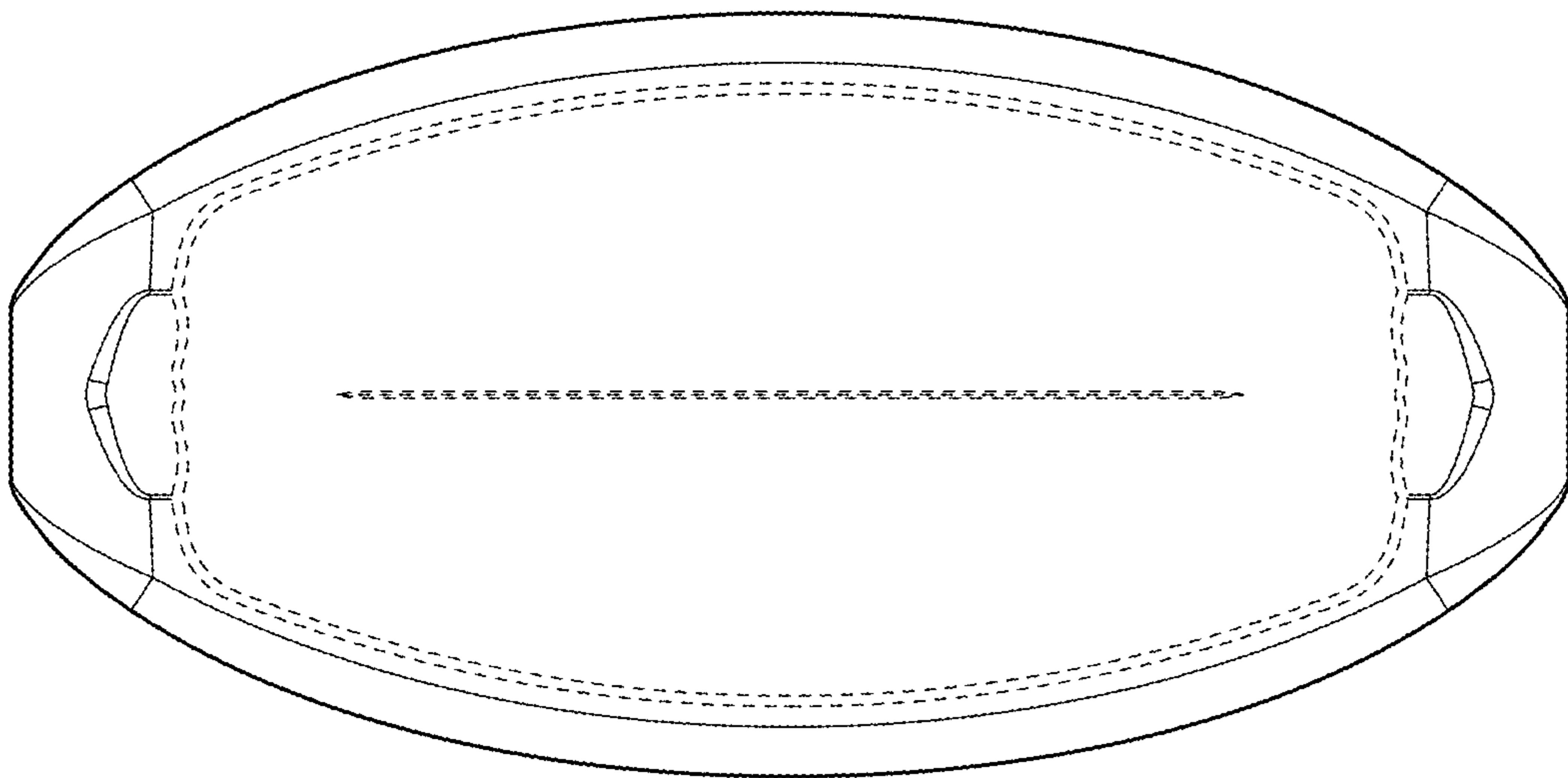

FIG. 14