



US00D932887S

(12) **United States Design Patent**  
**Kattan et al.**

(10) **Patent No.:** **US D932,887 S**

(45) **Date of Patent:** **\*\* Oct. 12, 2021**

(54) **PACKAGING FOR FRAGRANCE BOTTLE**

(71) Applicant: **Huda Beauty Limited**, Tortola (VG)

(72) Inventors: **Huda H. Kattan**, Dubai (AE); **Mona Kattan**, Dubai (AE); **Marine Malak**, Dubai (AE); **Charlotte Haberer**, Dubai (AE)

(73) Assignee: **Huda Beauty Limited**, Tortola (VG)

(\*\*) Term: **15 Years**

(21) Appl. No.: **29/689,298**

(22) Filed: **Apr. 29, 2019**

(51) **LOC (13) Cl.** ..... **09-03**

(52) **U.S. Cl.**  
USPC ..... **D9/430**

(58) **Field of Classification Search**  
USPC ..... D9/414-423, 430-433, 434, 456, 457,  
D9/711, 713, 721-722, 737, 756, 758,  
D9/759, 760; D20/10, 22, 27, 40, 42  
CPC ... B65D 5/00; B65D 5/02; B65D 5/18; B65D  
5/20

See application file for complete search history.

(56) **References Cited**

**U.S. PATENT DOCUMENTS**

D21,372 S *	3/1892	Meinecke	.....	D9/737
1,636,306 A *	7/1927	Keeler, Jr.	.....	B65D 5/00 229/104
1,702,945 A *	2/1929	Meisner	.....	B65D 5/00 229/104
D92,782 S *	7/1934	Tourtois	.....	D9/721
2,405,564 A *	8/1946	Evans	.....	B65D 5/18 229/110
D332,399 S *	1/1993	Neff	.....	D9/423
D344,234 S *	2/1994	Kaplan	.....	D3/294
D344,676 S *	3/1994	Newman	.....	D9/423
D360,581 S *	7/1995	Dikowitz	.....	D3/302

D380,153 S *	6/1997	Riddell	.....	D21/392
D683,241 S *	5/2013	Ghini	.....	D9/721
D693,675 S *	11/2013	Staller	.....	D9/430
8,584,926 B2 *	11/2013	Bull	.....	B65D 5/2033 229/109
D726,532 S *	4/2015	Lee	.....	D9/426
D762,123 S *	7/2016	de Baschmakoff	.....	D9/636
D784,805 S *	4/2017	Perkins	.....	D9/430
D804,301 S *	12/2017	Aono	.....	D9/430
D843,831 S *	3/2019	Poorman	.....	D9/431
2007/0228119 A1 *	10/2007	Barner	.....	B65D 5/48014 229/109

**OTHER PUBLICATIONS**

Kayali Miniature Set. [online] Retrieved Jul. 30, 20 from URL:  
[https://hudabeauty.com/US/en\\_US/shop/kayali-miniature-set-KY00009.html](https://hudabeauty.com/US/en_US/shop/kayali-miniature-set-KY00009.html).\*

(Continued)

*Primary Examiner* — Vy N Koenig

(74) *Attorney, Agent, or Firm* — Boyle Fredrickson, S.C.

(57) **CLAIM**

The ornamental design for a packaging for fragrance bottle, as shown and described.

**DESCRIPTION**

FIG. 1 is a front perspective view of a packaging for fragrance bottle showing our new design; FIG. 2 is a front view of the packaging of FIG. 1; FIG. 3 is a rear side view of the packaging of FIG. 1; FIG. 4 is right side view of the packaging of FIG. 1; FIG. 5 is a left side view of the packaging of FIG. 1; FIG. 6 is a top view of the packaging of FIG. 1; and, FIG. 7 is a front perspective view of the packaging of FIG. 1, shown in an open position. The evenly dashed broken lines in the drawings depict surface treatment of the packaging which form no part of the claimed design.

**1 Claim, 7 Drawing Sheets**

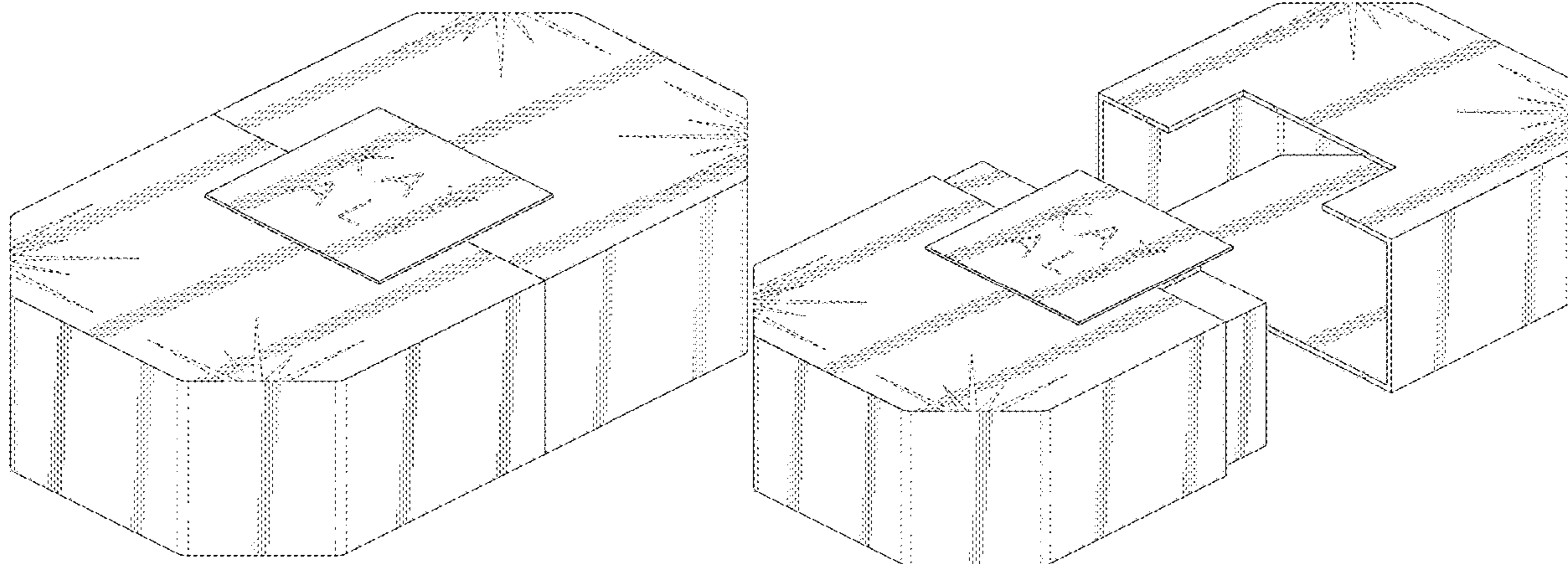

(56)

**References Cited**

OTHER PUBLICATIONS

Kayali Collection | 01. [online] Retrieved Jul. 30 from URL: [https://hudabeauty.com/US/en\\_US/shop/kayali-vanilla-28-50ml-KY00007.html](https://hudabeauty.com/US/en_US/shop/kayali-vanilla-28-50ml-KY00007.html).\*

Paper Mache Rectangular Octagon Box Set. [online] Retrieved Jun. 25, 2020 from URL: [https://factorydirectcraft.com/catalog/products/1302\\_2533\\_1475-55588-paper\\_mache\\_rectangular\\_octagon\\_box\\_set.html#](https://factorydirectcraft.com/catalog/products/1302_2533_1475-55588-paper_mache_rectangular_octagon_box_set.html#).\*

\* cited by examiner

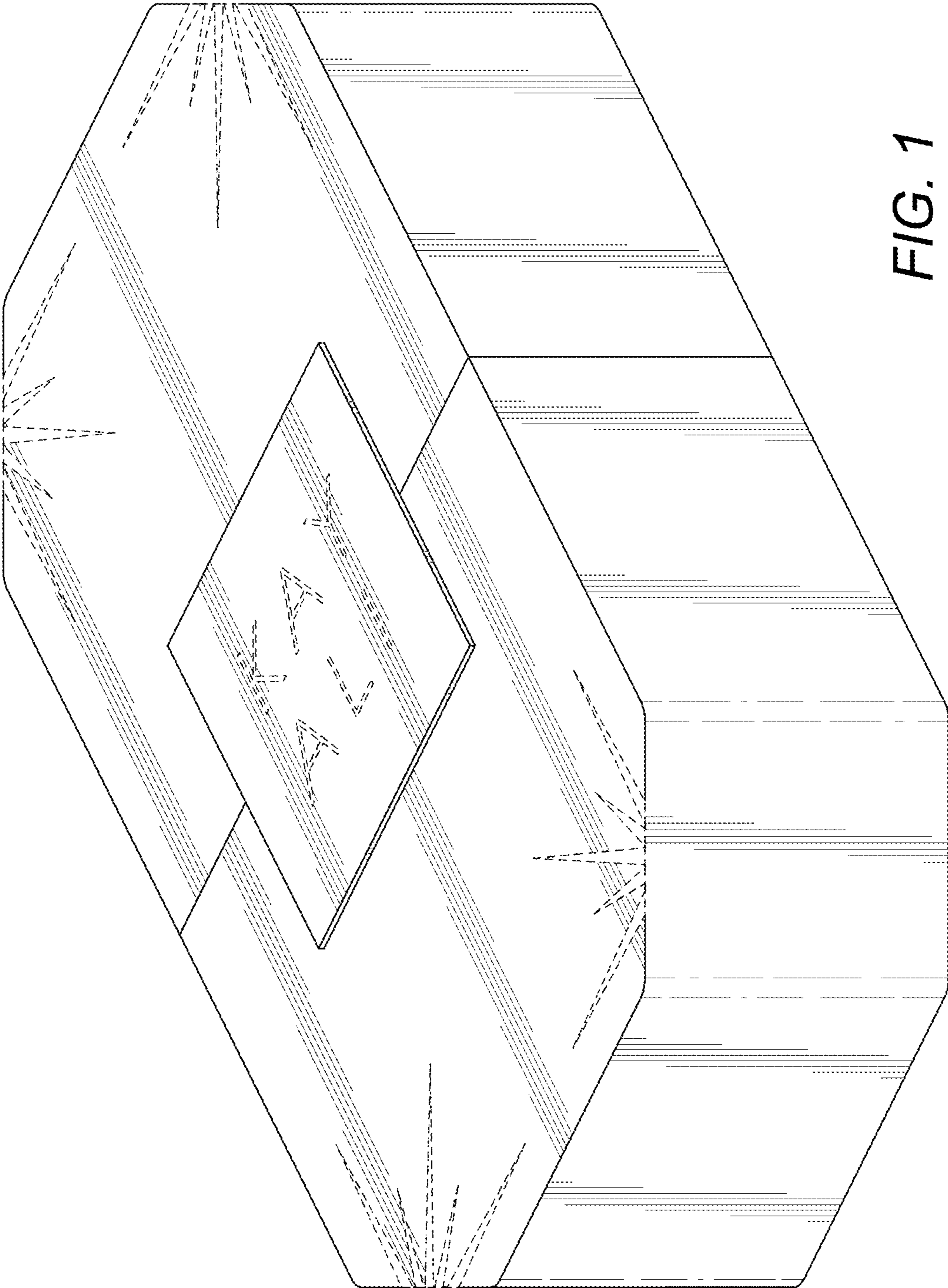

FIG. 1

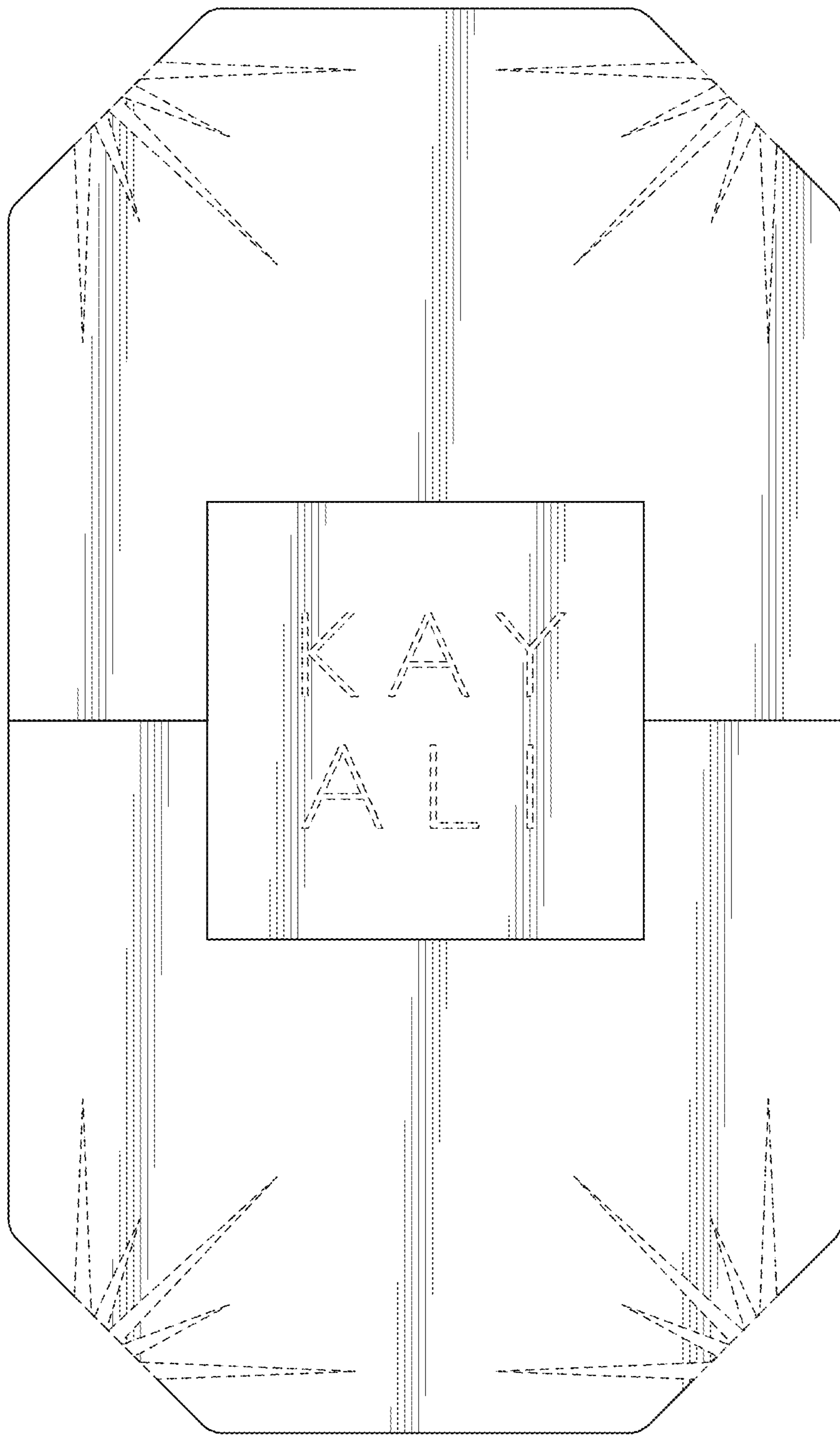
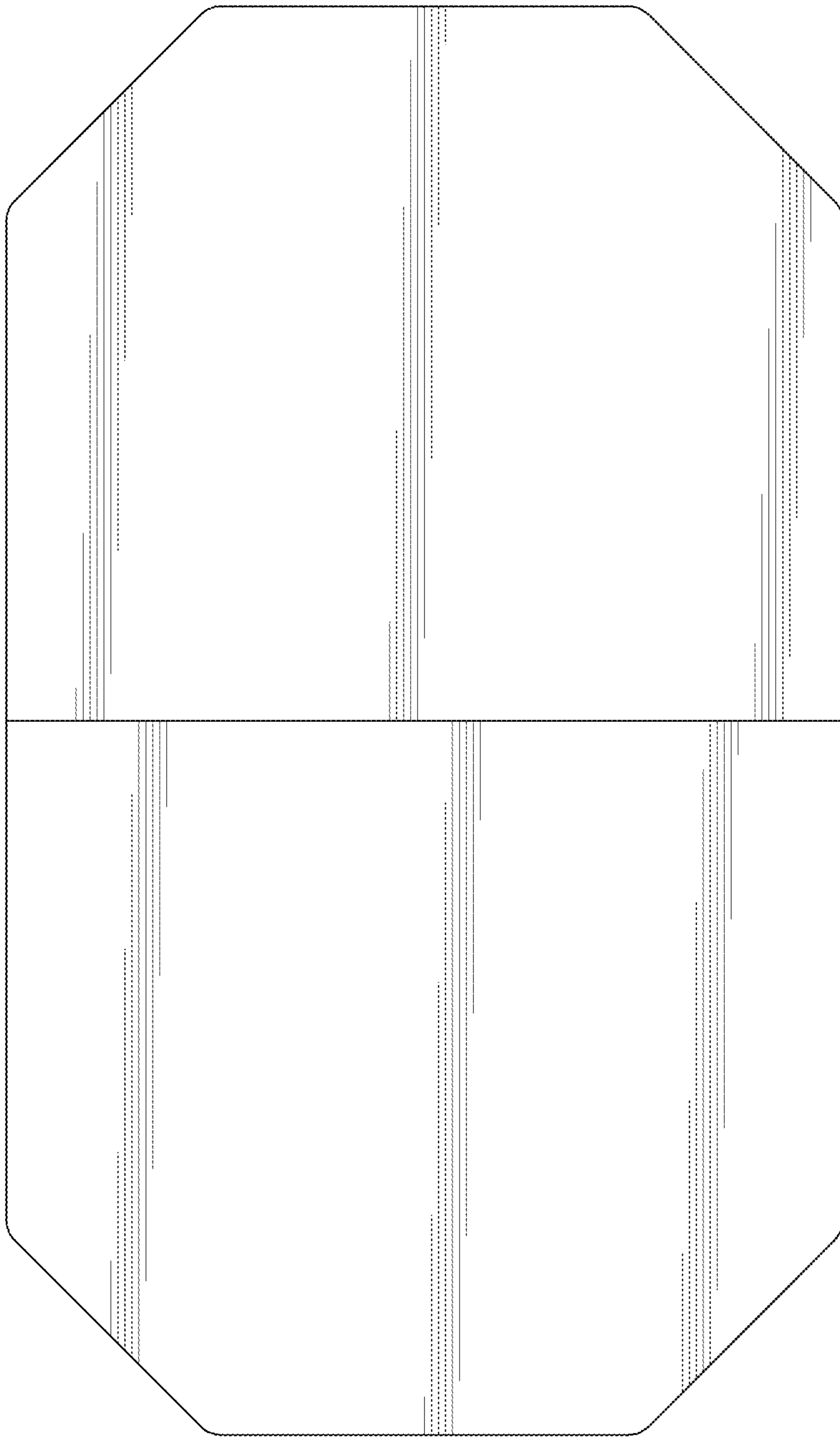
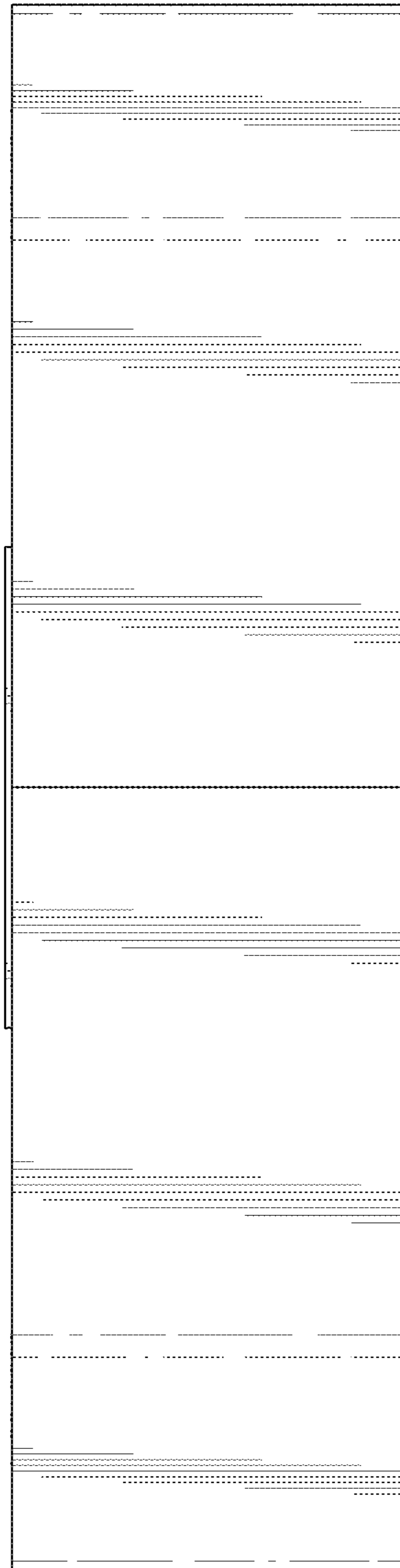

FIG. 2



*FIG. 3*



*FIG. 4*

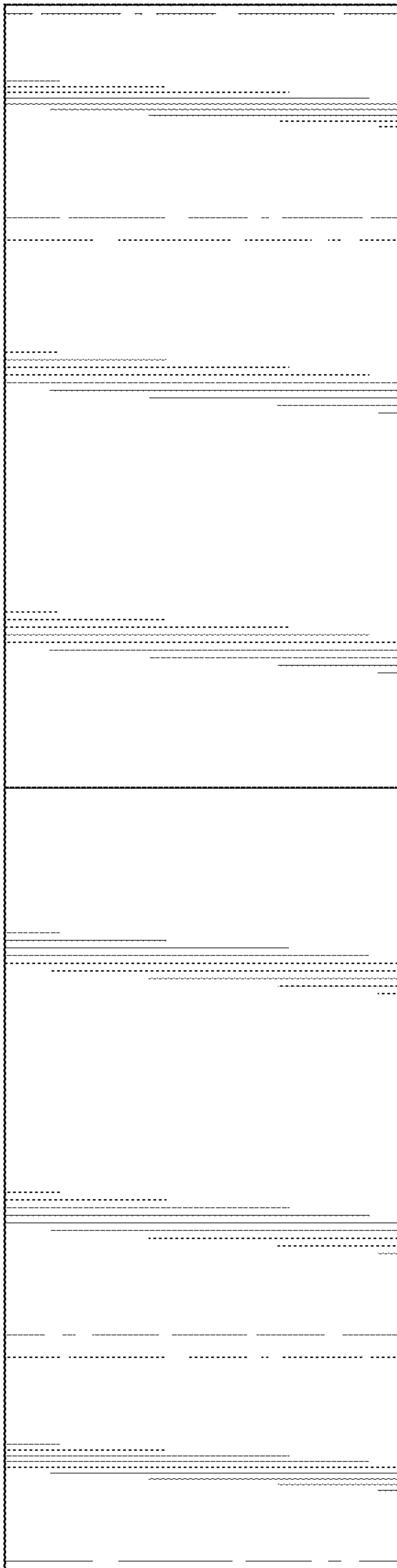

*FIG. 5*

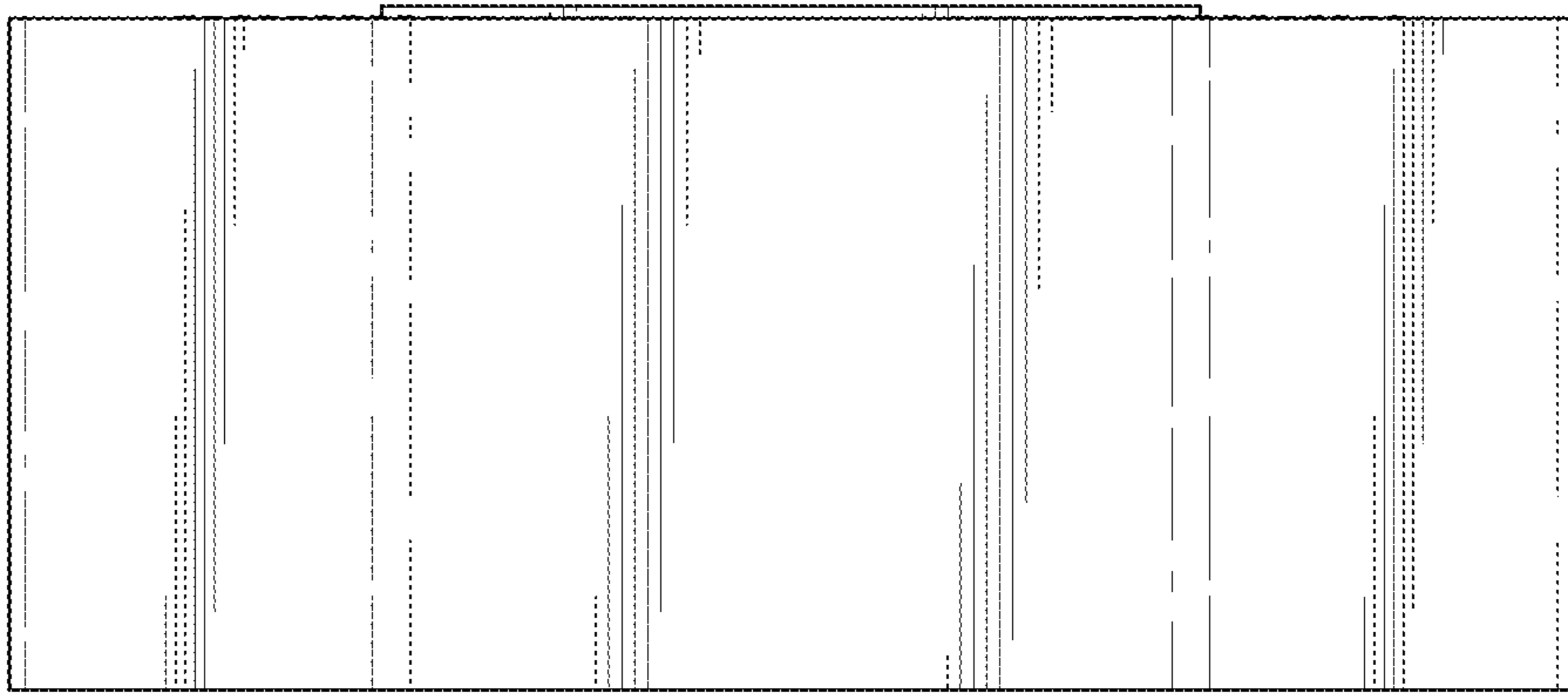

*FIG. 6*



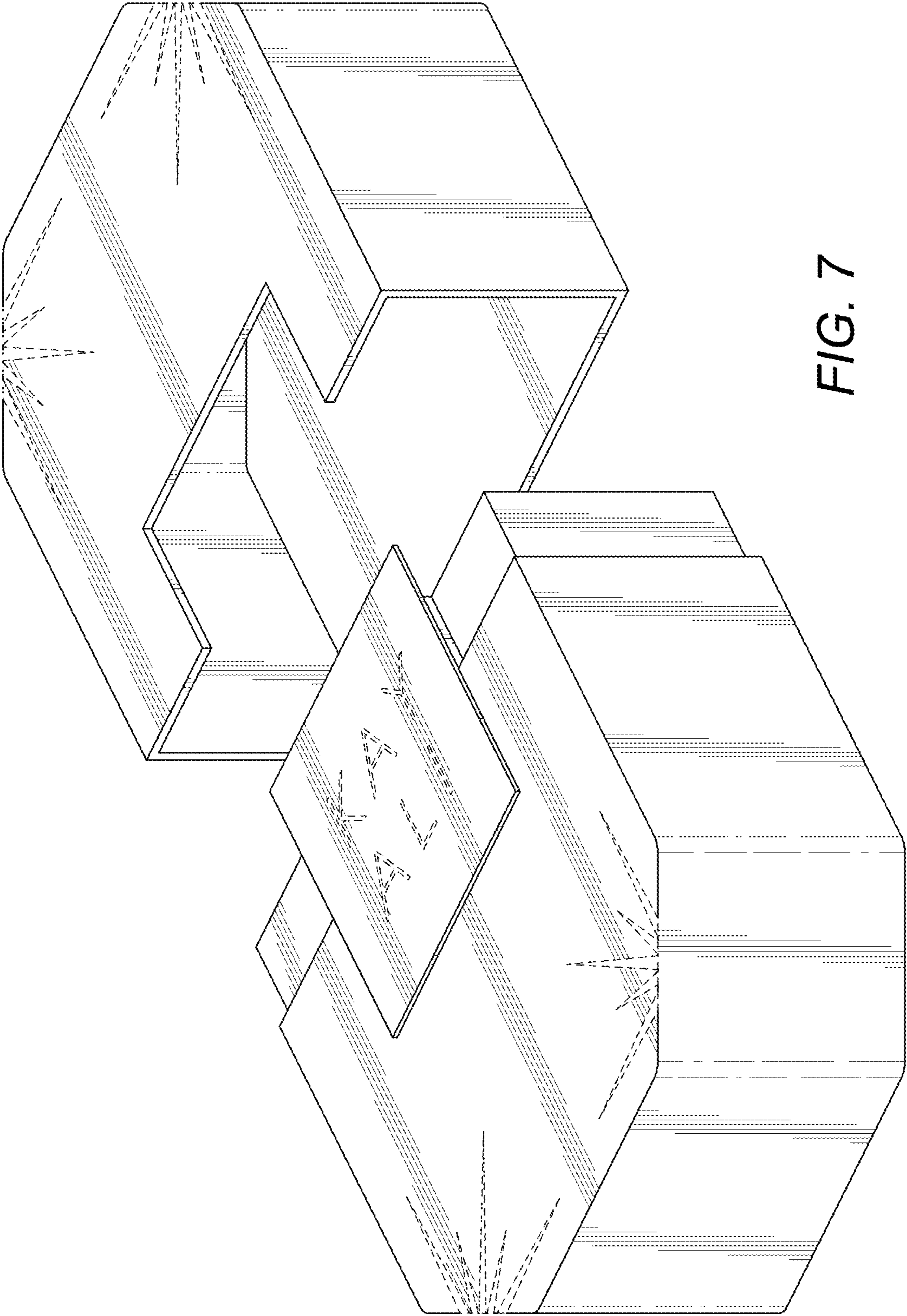

FIG. 7

UNITED STATES PATENT AND TRADEMARK OFFICE  
**CERTIFICATE OF CORRECTION**

PATENT NO. : D932,887 S  
APPLICATION NO. : 29/689298  
DATED : October 12, 2021  
INVENTOR(S) : Huda H. Kattan et al.

Page 1 of 1

It is certified that error appears in the above-identified patent and that said Letters Patent is hereby corrected as shown below:

On the Title Page

Insert item (30), --European Design Application EM 005834603, filed November 26, 2018--.

Signed and Sealed this  
Eighth Day of November, 2022  
*Katherine Kelly Vidal*

Katherine Kelly Vidal  
*Director of the United States Patent and Trademark Office*