



US00D932853S

(12) **United States Design Patent** (10) **Patent No.:** **US D932,853 S**
Roberts et al. (45) **Date of Patent:** **** Oct. 12, 2021**

(54) **ENGINE VALVE LIFTER HAVING ANTI-ROTATION PLUG**

FOREIGN PATENT DOCUMENTS

WO 2015106051 A1 7/2015

(71) Applicant: **Eaton Corporation**, Cleveland, OH (US)

OTHER PUBLICATIONS

(72) Inventors: **Leighton Roberts**, Kalamazoo, MI (US); **Kevin Matson**, Marshall, MI (US); **Douglas Wright**, Nottawa, MI (US); **James E. McCarthy, Jr.**, Kalamazoo, MI (US); **Matthew Vance**, Kalamazoo, MI (US); **Otto Schultheis**, Albion, MI (US)

International Search Report and Written Opinion for International Application No. PCT/US2017/018247 dated May 29, 2017, 14 pages.

Primary Examiner — Michael C Stout
Assistant Examiner — Fritzgerald L Butac
(74) *Attorney, Agent, or Firm* — RMCK Law Group PLC

(73) Assignee: **Eaton Intelligent Power Limited**, Dublin (IE)

(57) **CLAIM**

(**) Term: **15 Years**

The ornamental design for an engine valve lifter having anti-rotation plug, as shown and described.

(21) Appl. No.: **29/631,218**

(22) Filed: **Dec. 28, 2017**

DESCRIPTION

Related U.S. Application Data

(63) Continuation-in-part of application No. 29/594,307, filed on Feb. 17, 2017, now Pat. No. Des. 885,439.

(51) **LOC (13) Cl.** **08-05**

(52) **U.S. Cl.**
USPC **D8/14**

(58) **Field of Classification Search**
USPC D8/21–29, 51, 88, 89, 107; D15/1–7, D15/148, 149
CPC F01B 25/10; F02D 9/08; F02K 9/58; F01L 1/143; F01L 1/181
See application file for complete search history.

FIG. 1 is a front perspective view of an engine valve lifter having anti-rotation plug in accordance with the present teachings.
FIG. 2 is a rear perspective view of the engine valve lifter having anti-rotation plug of FIG. 1.
FIG. 3 is a first side view of the engine valve lifter having anti-rotation plug of FIG. 1.
FIG. 4 is a front view of the engine valve lifter having anti-rotation plug of FIG. 1.
FIG. 5 is a second side view of the engine valve lifter having anti-rotation plug of FIG. 1.
FIG. 6 is a rear view of the engine valve lifter having anti-rotation plug of FIG. 1.
FIG. 7 is a bottom view of the engine valve lifter having anti-rotation plug of FIG. 1; and,
FIG. 8 is a top view of the engine valve lifter having anti-rotation plug of FIG. 1.

The broken line showing portions of the engine valve lifter having anti-rotation plug form no part of the claimed design.

(56) **References Cited**

U.S. PATENT DOCUMENTS

D301,298 S * 5/1989 Porrello D8/14
D429,978 S * 8/2000 Fallandy D8/14
D636,645 S * 4/2011 Bell D8/14

(Continued)

1 Claim, 7 Drawing Sheets

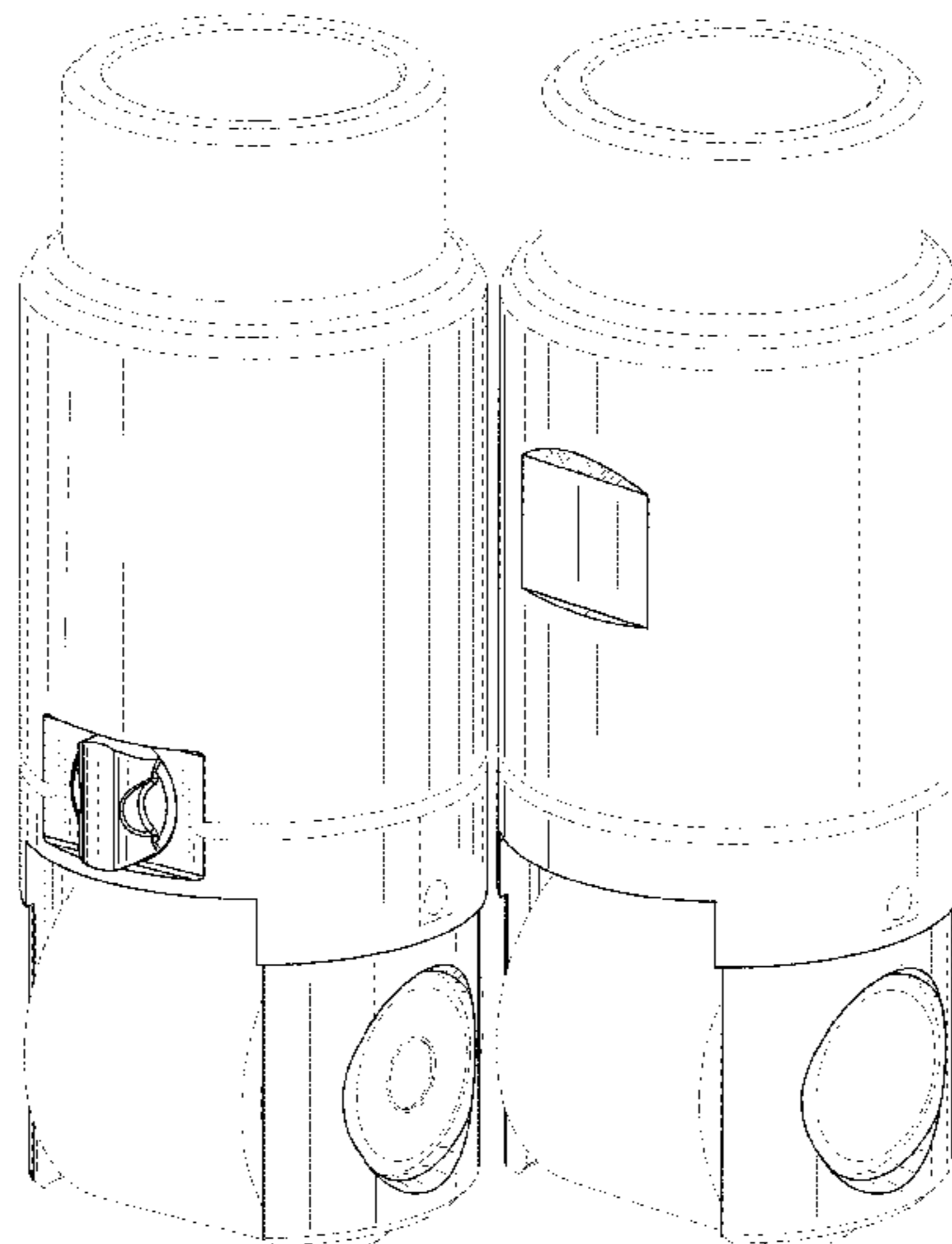

(56)

References Cited

U.S. PATENT DOCUMENTS

D749,382 S * 2/2016 Matsuoka D8/14
D847,595 S * 5/2019 Hampton D8/14
D875,494 S * 2/2020 Widner D8/51
D885,439 S * 5/2020 Roberts 15/5
2011/0259142 A1 10/2011 Copper et al.
2018/0363513 A1* 12/2018 Roberts F01L 1/2405

* cited by examiner

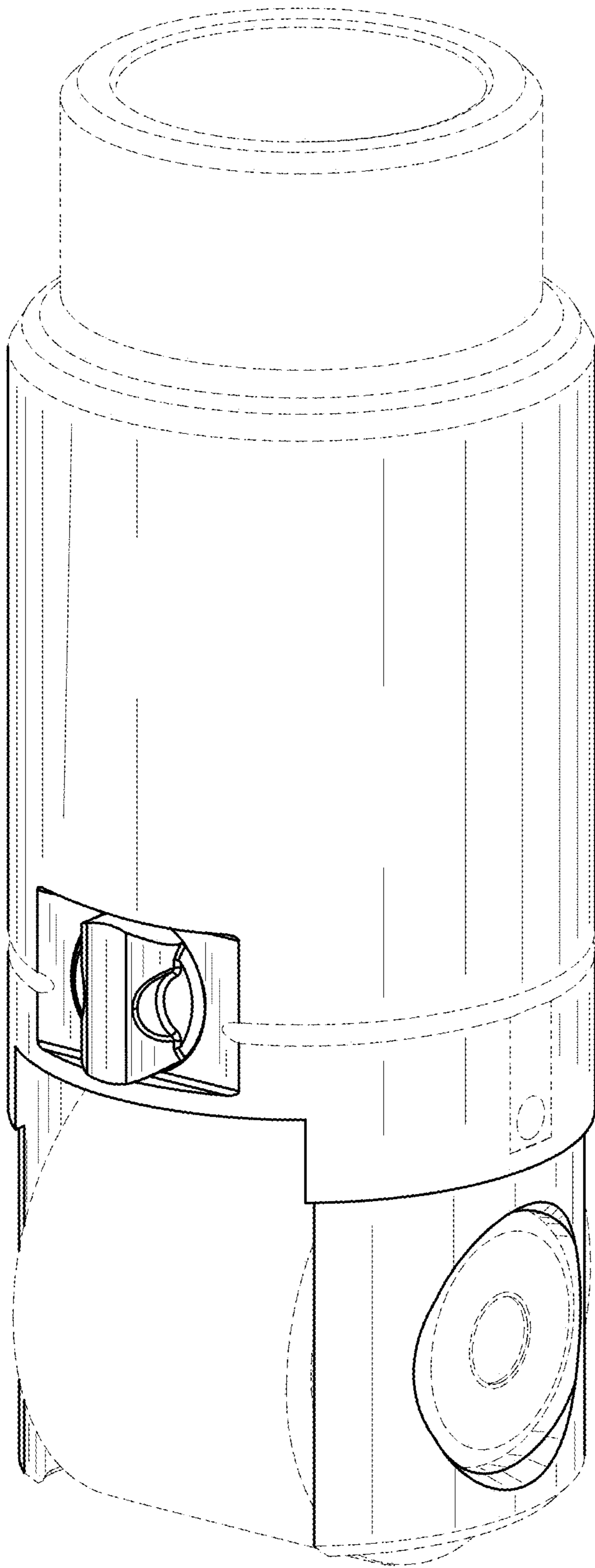

FIG - 1

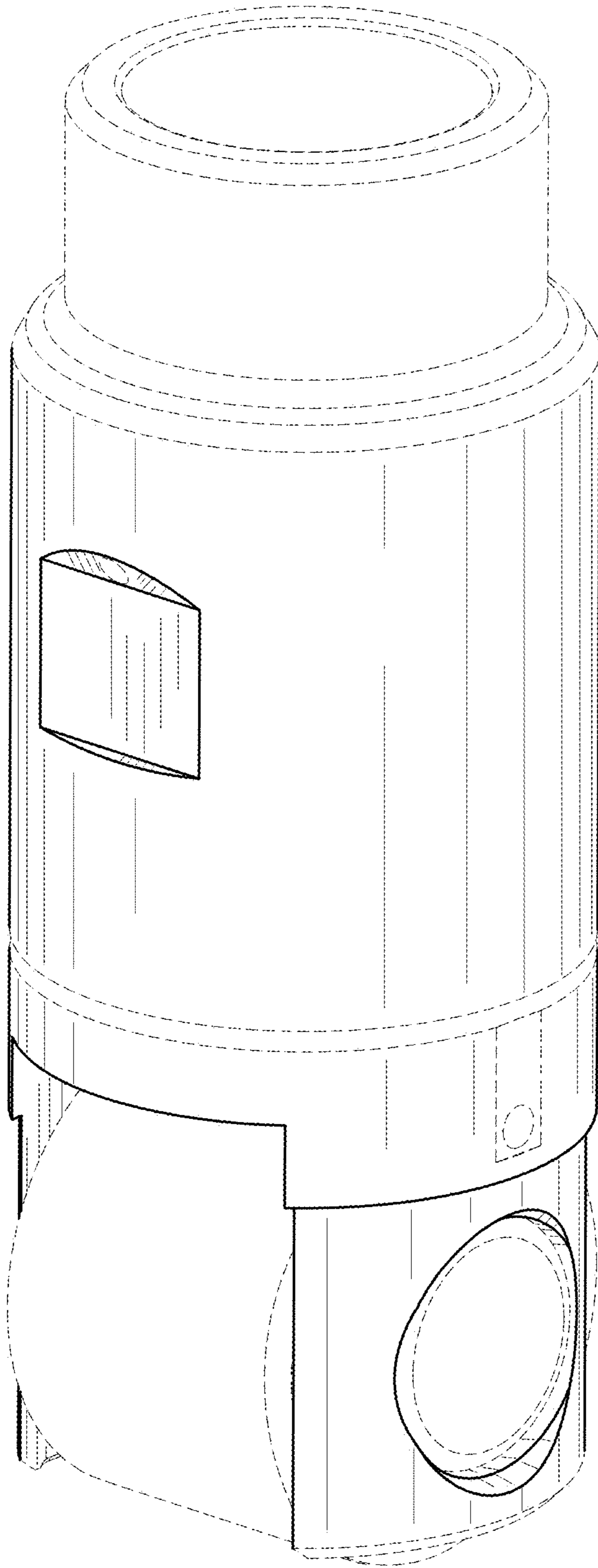

FIG - 2

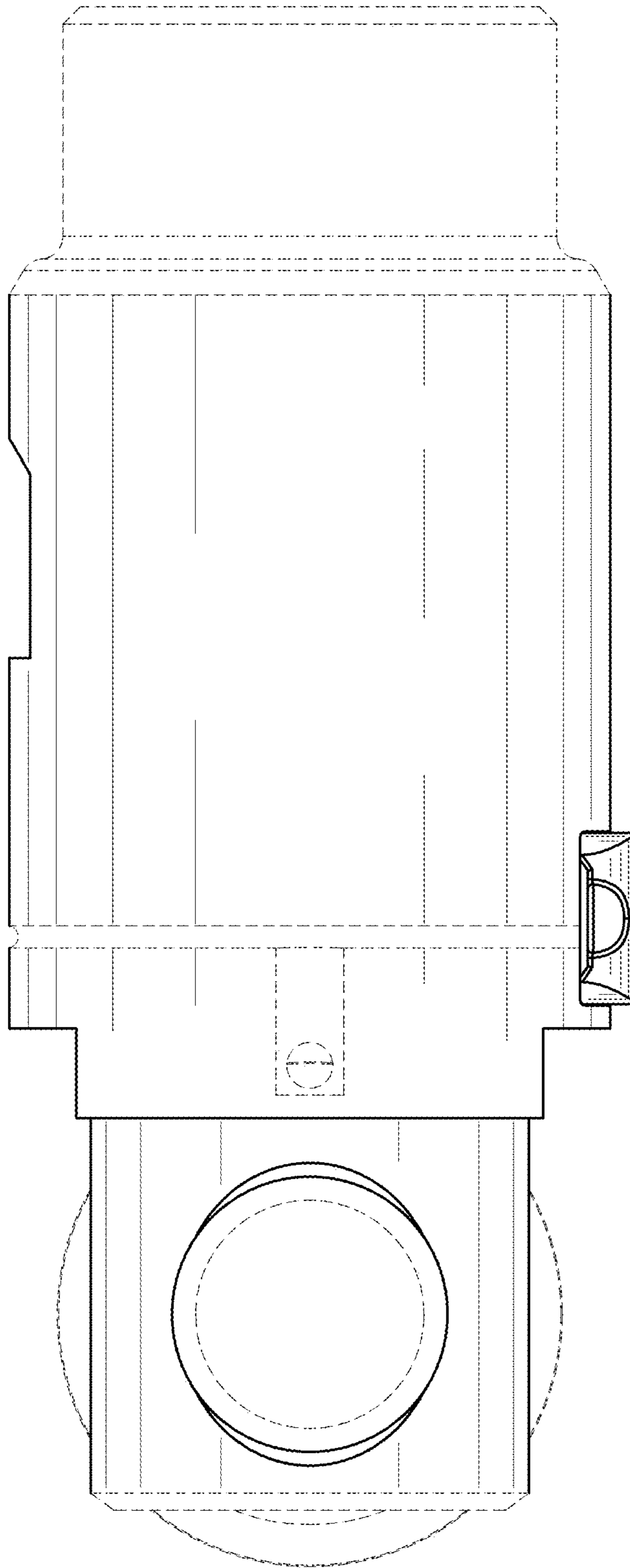

FIG - 3

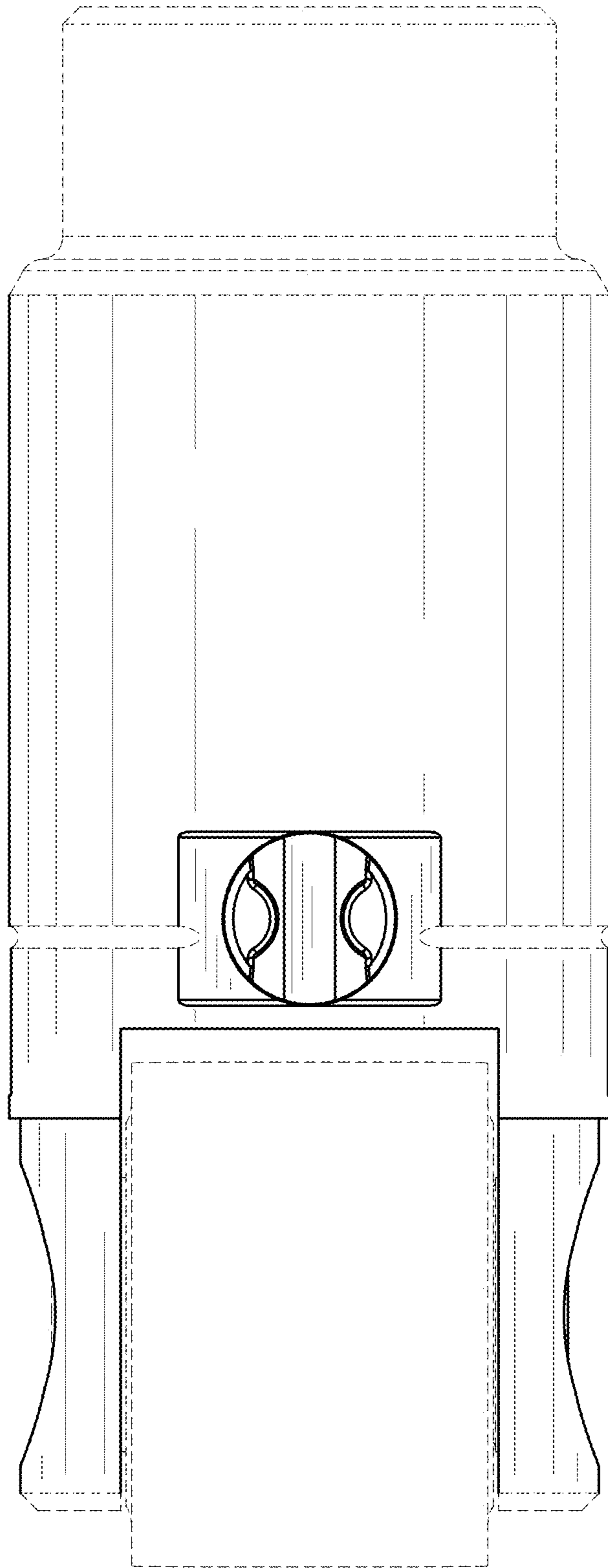

FIG - 4

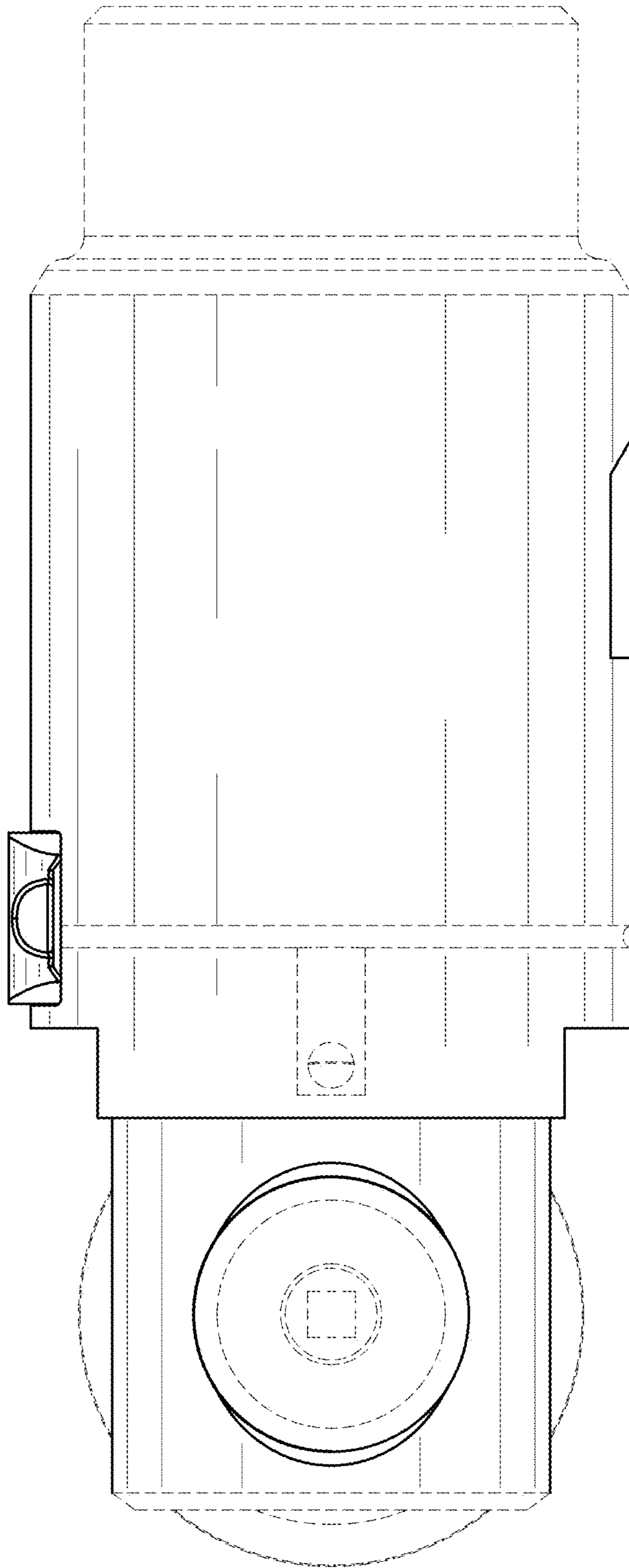

FIG - 5

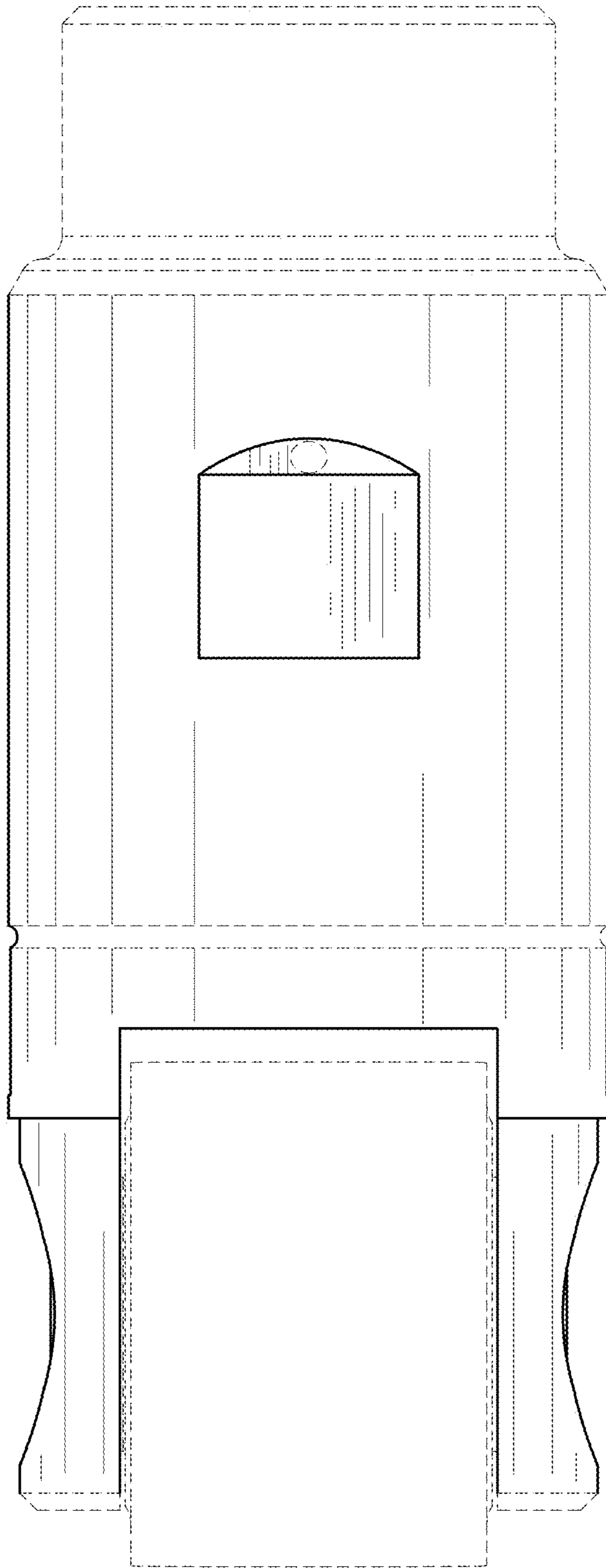

FIG - 6

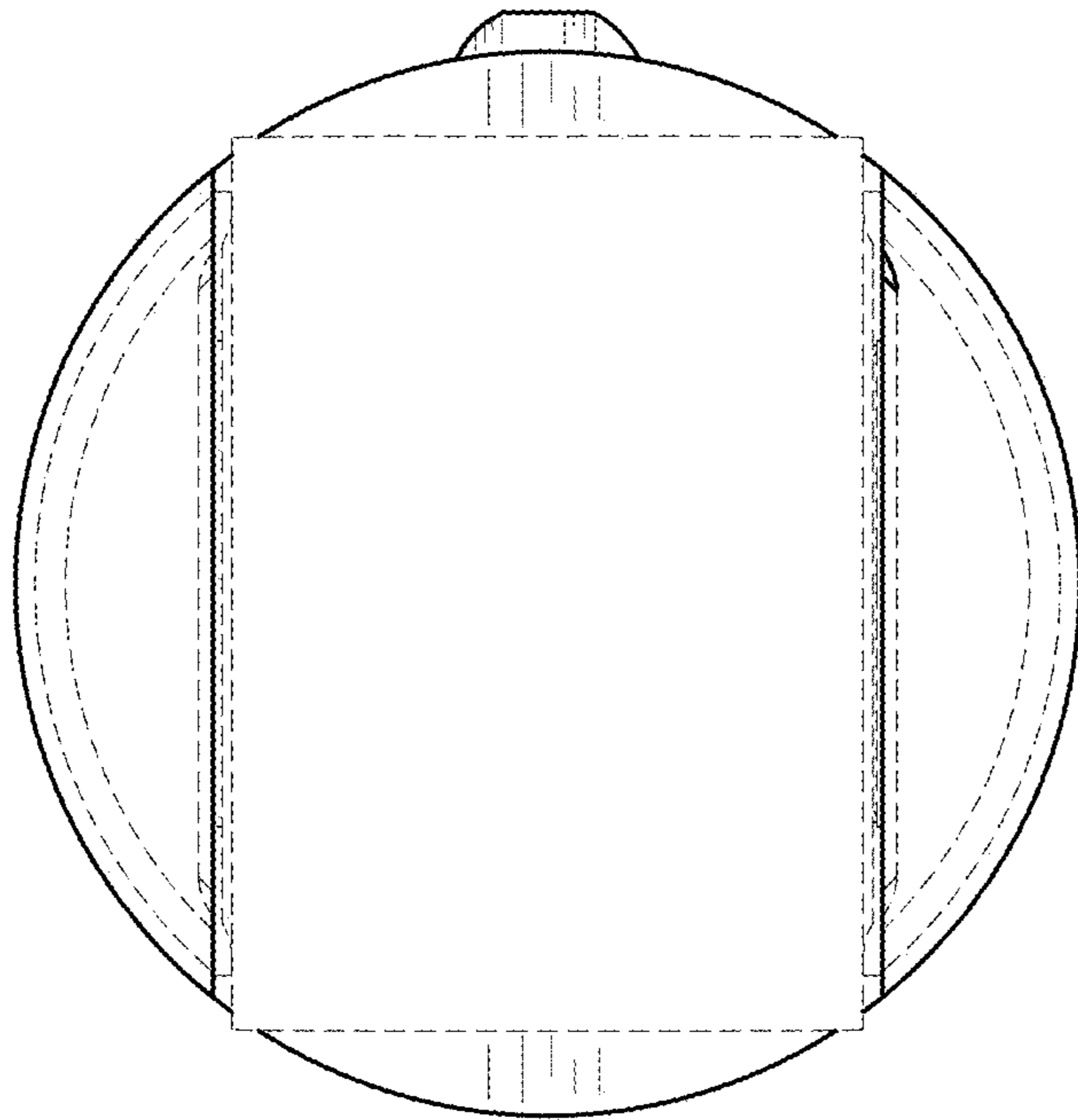

FIG - 7

FIG - 8

