



US00D932843S

(12) **United States Design Patent** (10) **Patent No.:** **US D932,843 S**  
**Ames** (45) **Date of Patent:** **\*\* Oct. 12, 2021**

(54) **FOOD JAR**  
(71) Applicant: **Real Value LLC**, Norman, OK (US)  
(72) Inventor: **Micah Ames**, Oklahoma City, OK (US)  
(73) Assignee: **Real Value LLC**, Moore, OK (US)  
(\*\*) Term: **15 Years**  
(21) Appl. No.: **29/676,572**  
(22) Filed: **Jan. 11, 2019**  
(51) **LOC (13) Cl.** ..... **07-07**  
(52) **U.S. Cl.**  
USPC ..... **D7/608; D7/511**  
(58) **Field of Classification Search**  
USPC ..... D7/590, 589, 630, 511, 608, 629;  
239/13; D9/522, 682; 222/146.5;  
215/200; 220/228  
CPC ..... A47G 19/26; B05B 9/002; B05B 9/005  
See application file for complete search history.

D790,920 S 7/2017 Goodwin et al.  
D791,579 S 7/2017 Goodwin et al.  
D805,852 S \* 12/2017 Seiders ..... D7/608  
D808,220 S 1/2018 Burns et al.  
D809,344 S \* 2/2018 Guthrie ..... D7/511  
(Continued)

*Primary Examiner* — Cynthia R Underwood  
(74) *Attorney, Agent, or Firm* — Hall Estill Law Firm

(57) **CLAIM**

The ornamental design for a food jar, as shown and described.

**DESCRIPTION**

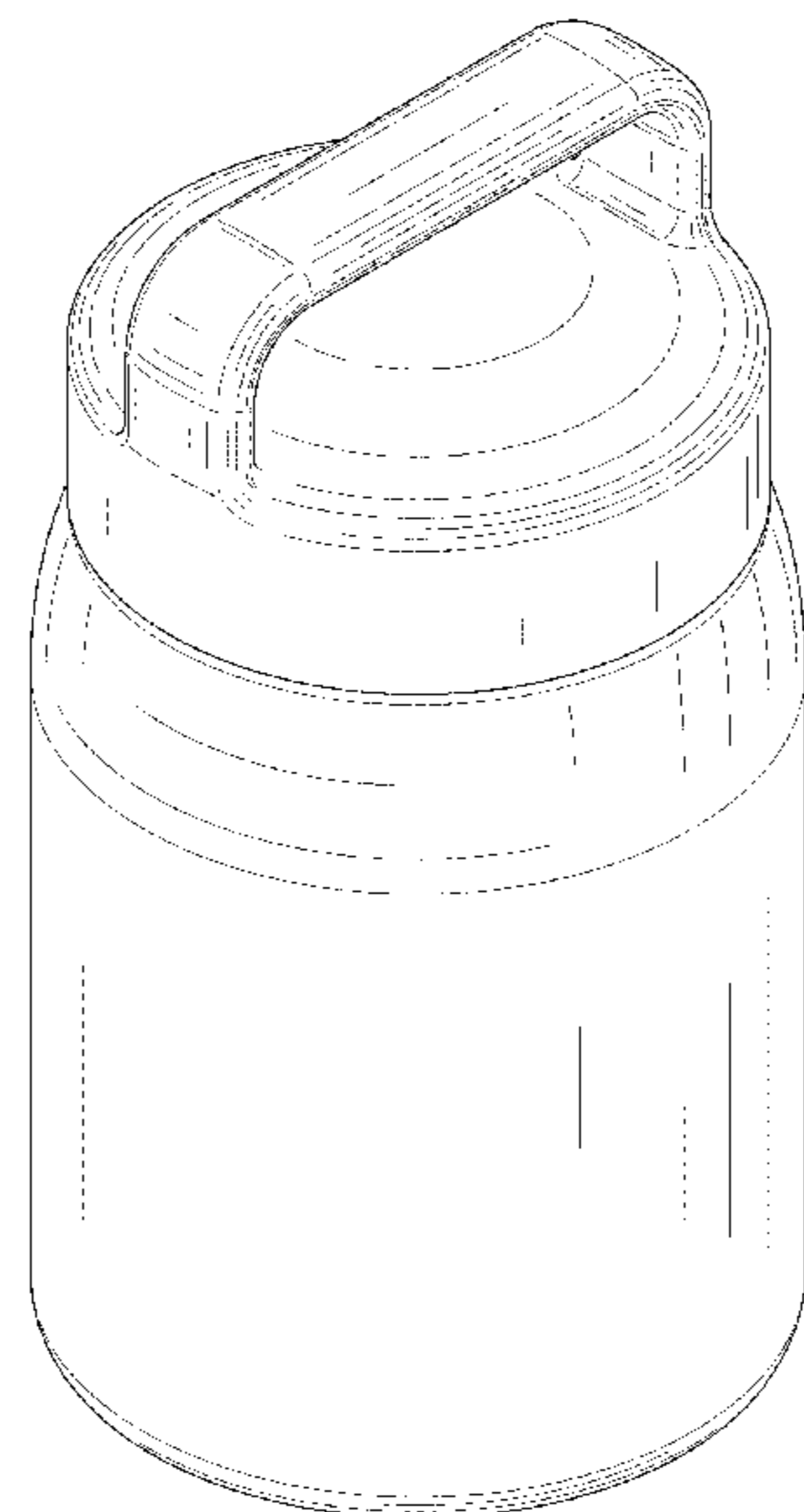
FIG. 1 is a top, perspective view showing a first embodiment of my new design for a food jar.  
FIG. 2 is a front side elevation view of FIG. 1.  
FIG. 3 is a rear side elevation of view of FIG. 1.  
FIG. 4 is a left side elevation view of FIG. 1.  
FIG. 5 is right side elevation view of FIG. 1.  
FIG. 6 is a top view of FIG. 1.  
FIG. 7 is a bottom view of FIG. 1.  
FIG. 8 is a top, perspective view showing a second embodiment of my new design for a food jar.  
FIG. 9 is a front side elevation view of FIG. 8.  
FIG. 10 is a rear side elevation of view of FIG. 8.  
FIG. 11 is a left side elevation view of FIG. 8.  
FIG. 12 is right side elevation view of FIG. 8.  
FIG. 13 is a top view of FIG. 8.  
FIG. 14 is a bottom view of FIG. 8.  
FIG. 15 is a top, perspective view showing a third embodiment of my new design for a food jar.  
FIG. 16 is a front side elevation view of FIG. 15.  
FIG. 17 is a rear side elevation of view of FIG. 15.  
FIG. 18 is a left side elevation view of FIG. 15.  
FIG. 19 is right side elevation view of FIG. 15.  
FIG. 20 is a top view of FIG. 15; and,  
FIG. 21 is a bottom view of FIG. 15.

(56) **References Cited**

U.S. PATENT DOCUMENTS

4,399,926 A \* 8/1983 Eidels-Dubovoy .... B65D 25/32  
220/284  
4,537,044 A \* 8/1985 Putnam ..... A45C 11/20  
220/902  
D620,357 S 7/2010 Jewett et al.  
D627,601 S \* 11/2010 Eyal ..... D7/510  
D648,177 S 11/2011 Eyal  
D672,238 S 12/2012 Aziz et al.  
D672,609 S \* 12/2012 Aziz ..... D7/510  
D696,079 S \* 12/2013 Meyers ..... D7/629  
D700,012 S 2/2014 Hurley et al.  
D713,365 S \* 9/2014 Green ..... D13/183  
D723,333 S 3/2015 Lin  
D724,385 S 3/2015 Hurley et al.  
D736,744 S \* 8/2015 Liu ..... D14/216  
D782,881 S \* 4/2017 Seiders ..... D7/608  
D787,935 S 5/2017 Kaiser  
D790,285 S \* 6/2017 Seiders ..... D7/608

**1 Claim, 21 Drawing Sheets**



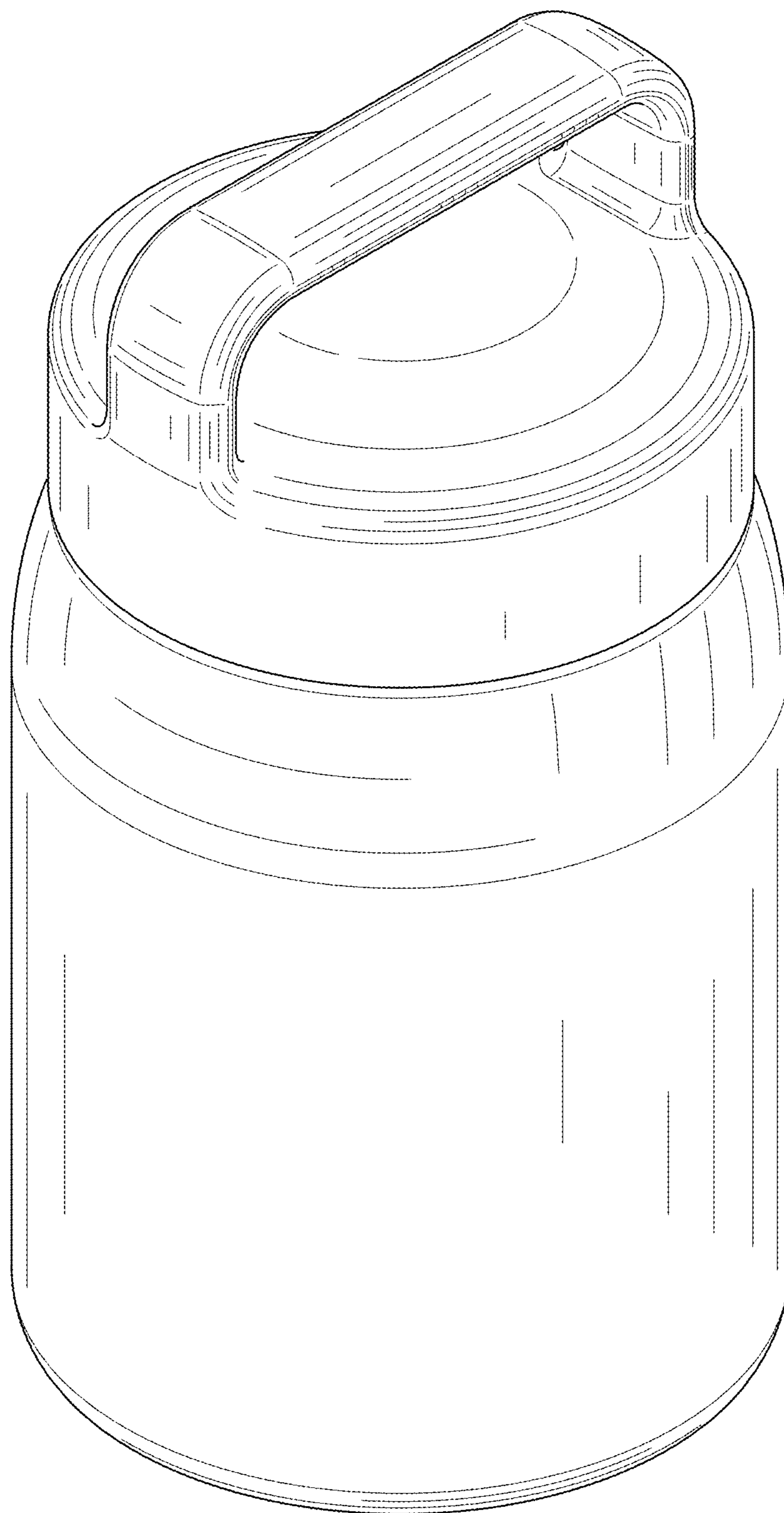
(56)

## References Cited

## U.S. PATENT DOCUMENTS

D809,920 S 2/2018 Maple  
D810,504 S 2/2018 Goodwin et al.  
D811,818 S \* 3/2018 Wu ..... D7/510  
D812,428 S \* 3/2018 Wu ..... D7/510  
D815,908 S 4/2018 Kauss et al.  
D818,775 S \* 5/2018 Woodruff ..... D7/510  
D819,396 S \* 6/2018 Seiders ..... D7/392.1  
D822,439 S 7/2018 Spivey et al.  
D839,054 S \* 1/2019 Rane ..... D7/608  
D839,055 S \* 1/2019 Rane ..... D7/608  
D856,757 S \* 8/2019 Seiders ..... D7/608  
D865,448 S \* 11/2019 Jacobsen ..... D7/511  
D865,449 S \* 11/2019 Jacobsen ..... D7/511  
D865,450 S \* 11/2019 Jacobsen ..... D7/511  
D866,258 S \* 11/2019 Jacobsen ..... D7/511  
D866,259 S \* 11/2019 Jacobsen ..... D7/511  
D866,260 S \* 11/2019 Jacobsen ..... D7/511  
D866,261 S \* 11/2019 Jacobsen ..... D7/511  
D867,067 S \* 11/2019 Jacobsen ..... D7/511  
D867,068 S \* 11/2019 Jacobsen ..... D7/511  
D867,820 S \* 11/2019 Jacobsen ..... D7/511  
D868,537 S \* 12/2019 Jacobsen ..... D7/511  
D868,538 S \* 12/2019 Jacobsen ..... D7/511  
D878,874 S \* 3/2020 Seiders ..... D7/608  
D897,782 S \* 10/2020 Lane ..... D7/608  
D899,859 S \* 10/2020 Jacobsen ..... D7/511  
D899,860 S \* 10/2020 Jacobsen ..... D7/511  
2017/0119212 A1 \* 5/2017 Petrillo ..... A47J 41/02

\* cited by examiner



**FIG. 1**

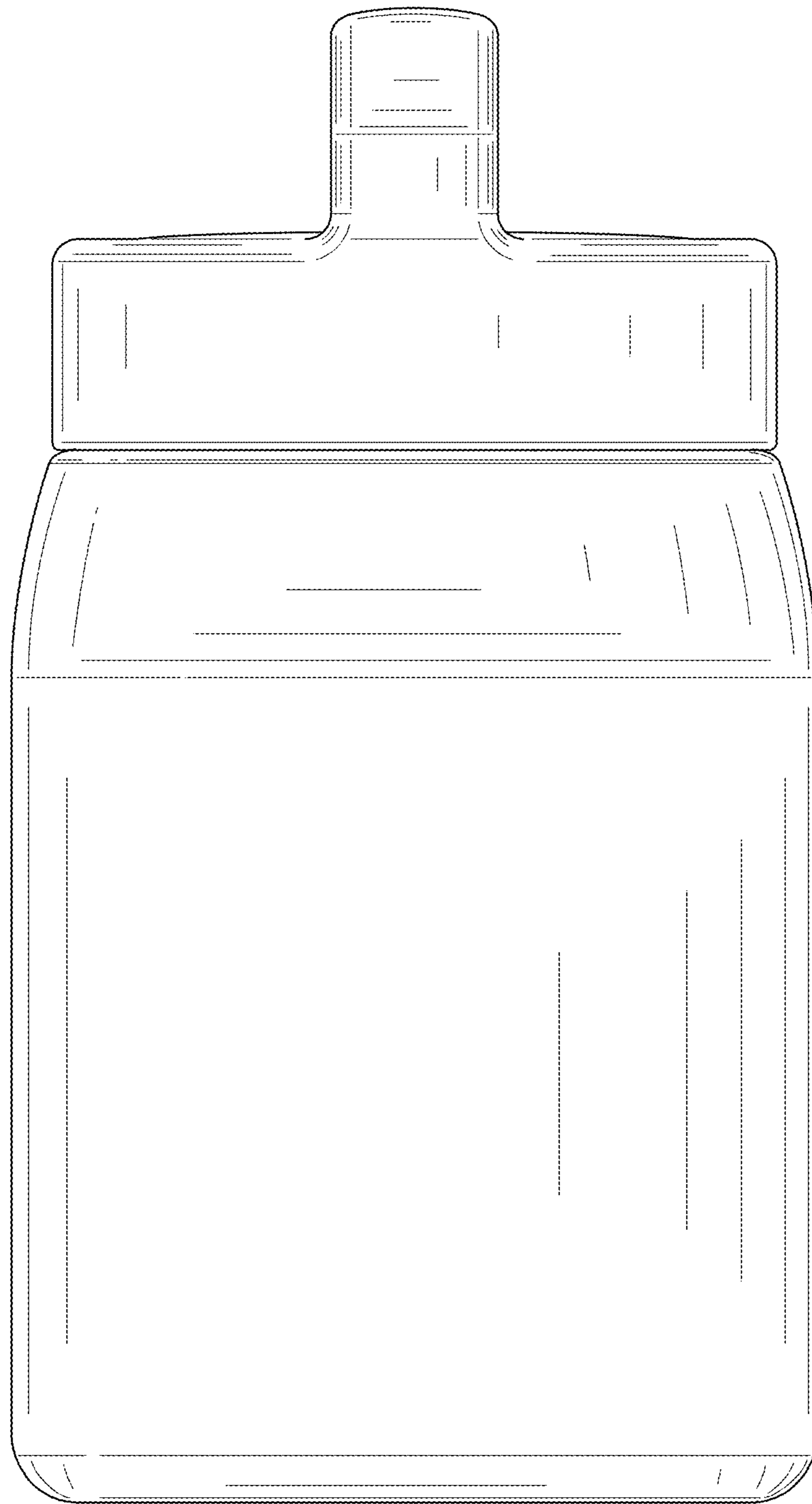
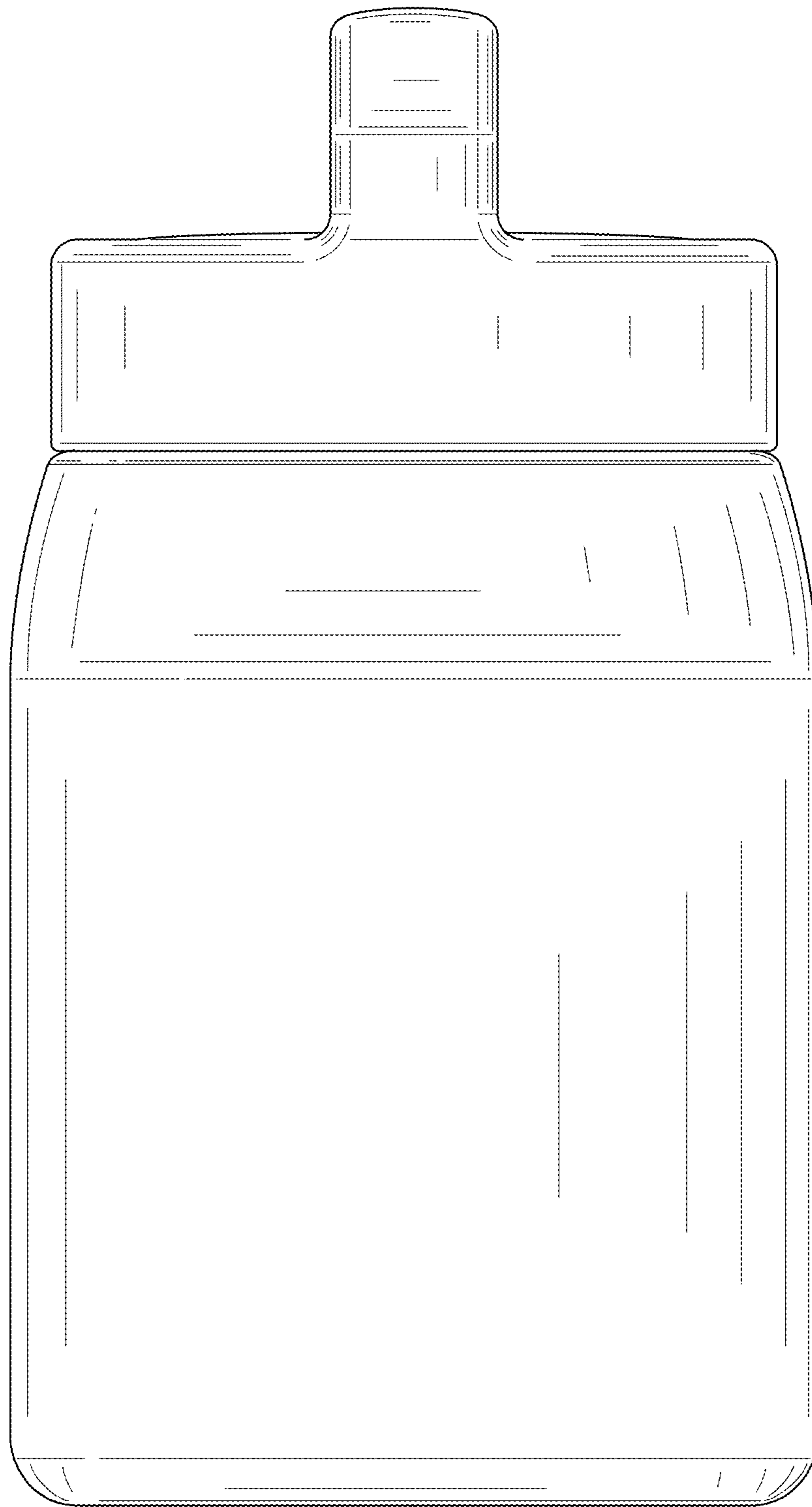
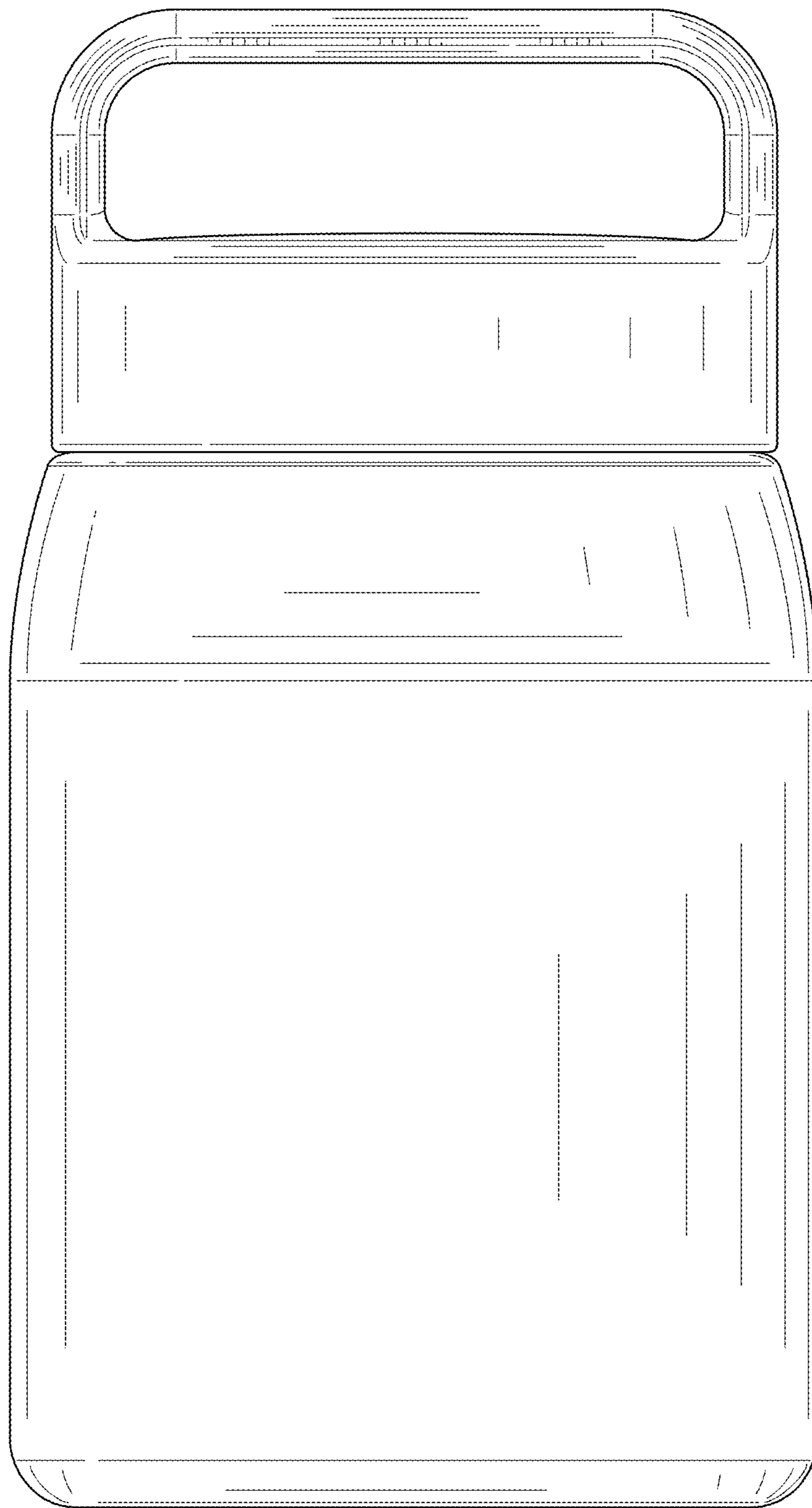


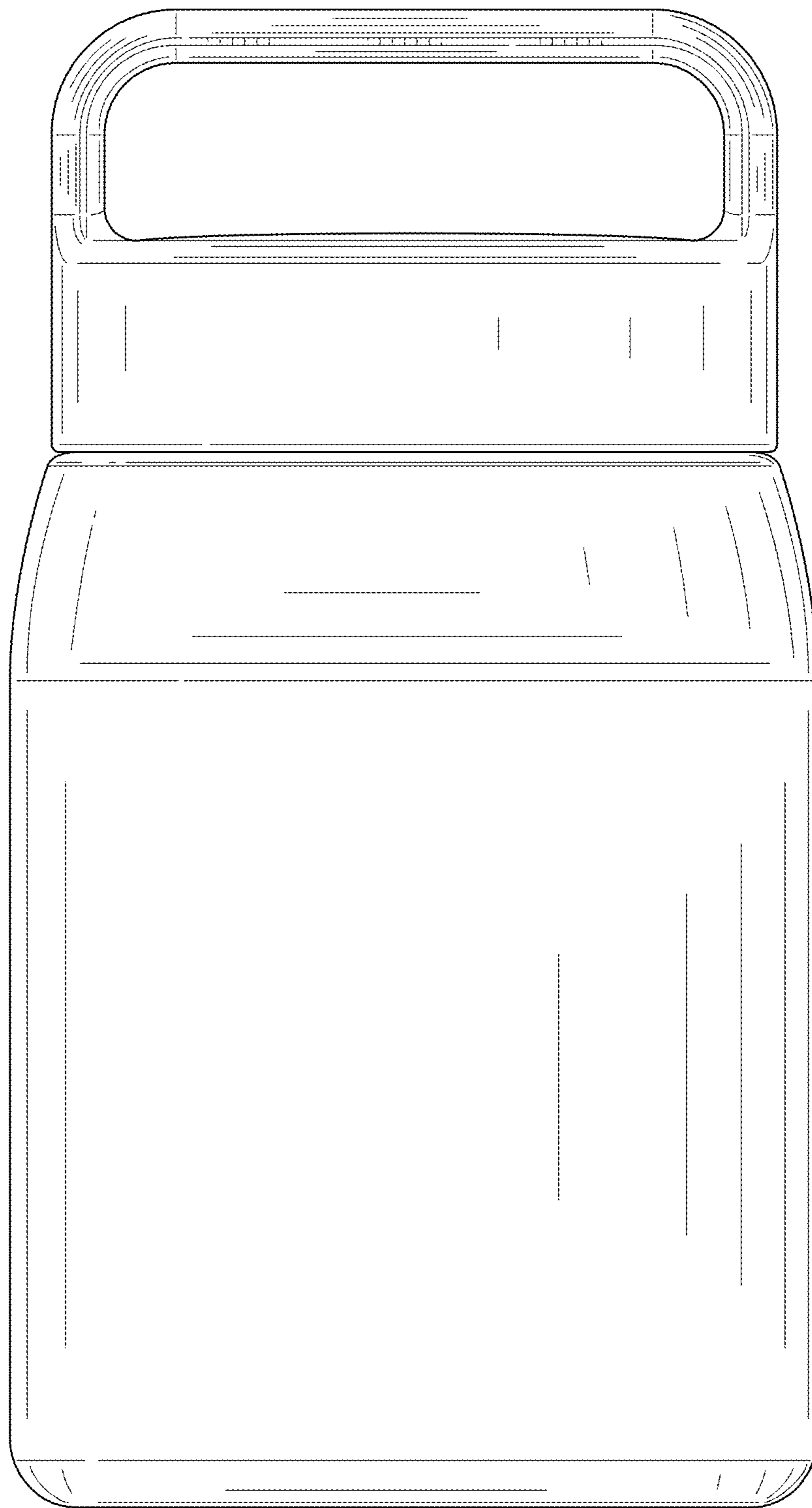
FIG. 2



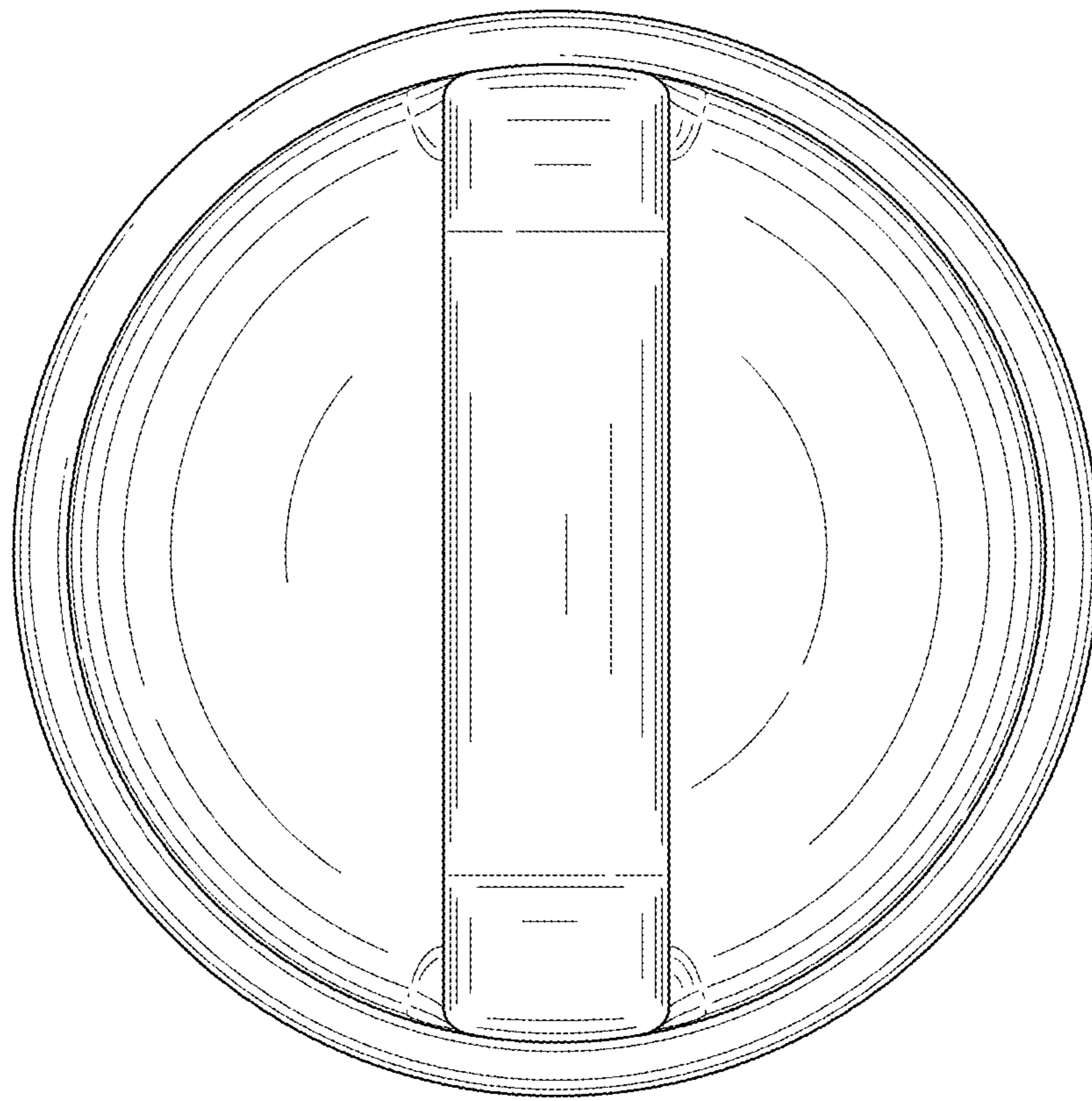
**FIG. 3**



**FIG. 4**

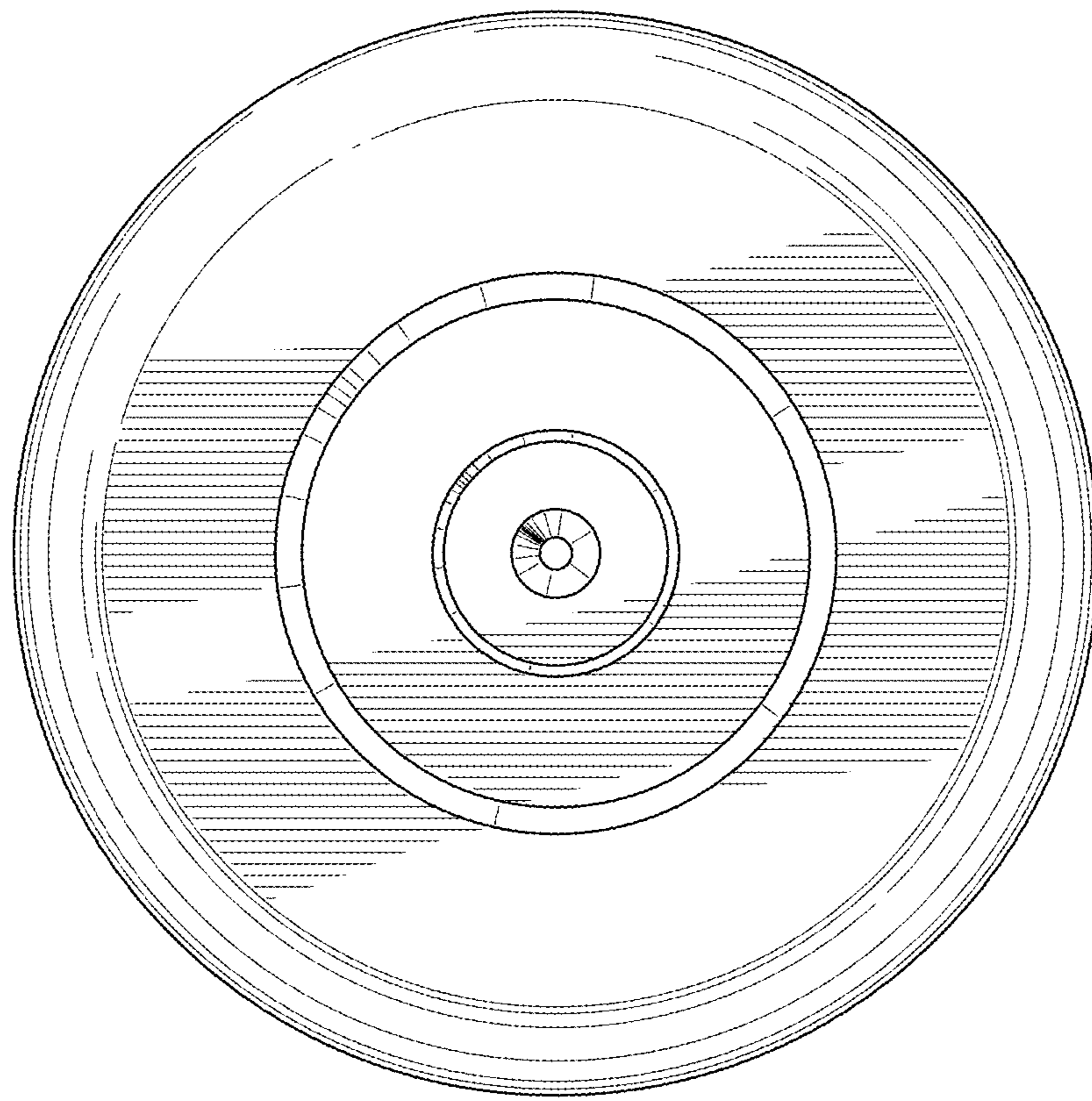


**FIG. 5**



**FIG. 6**





**FIG. 7**

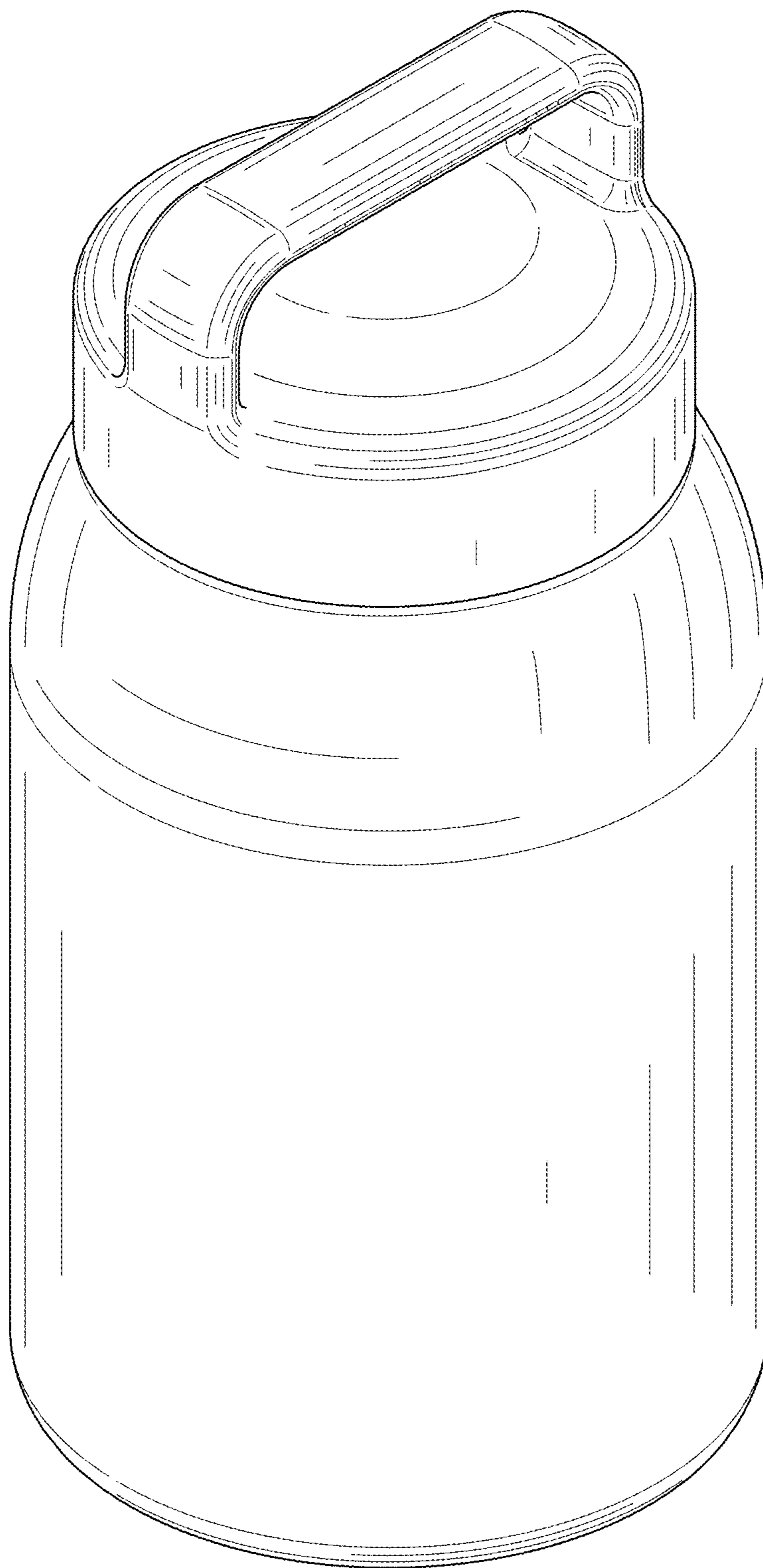


FIG. 8

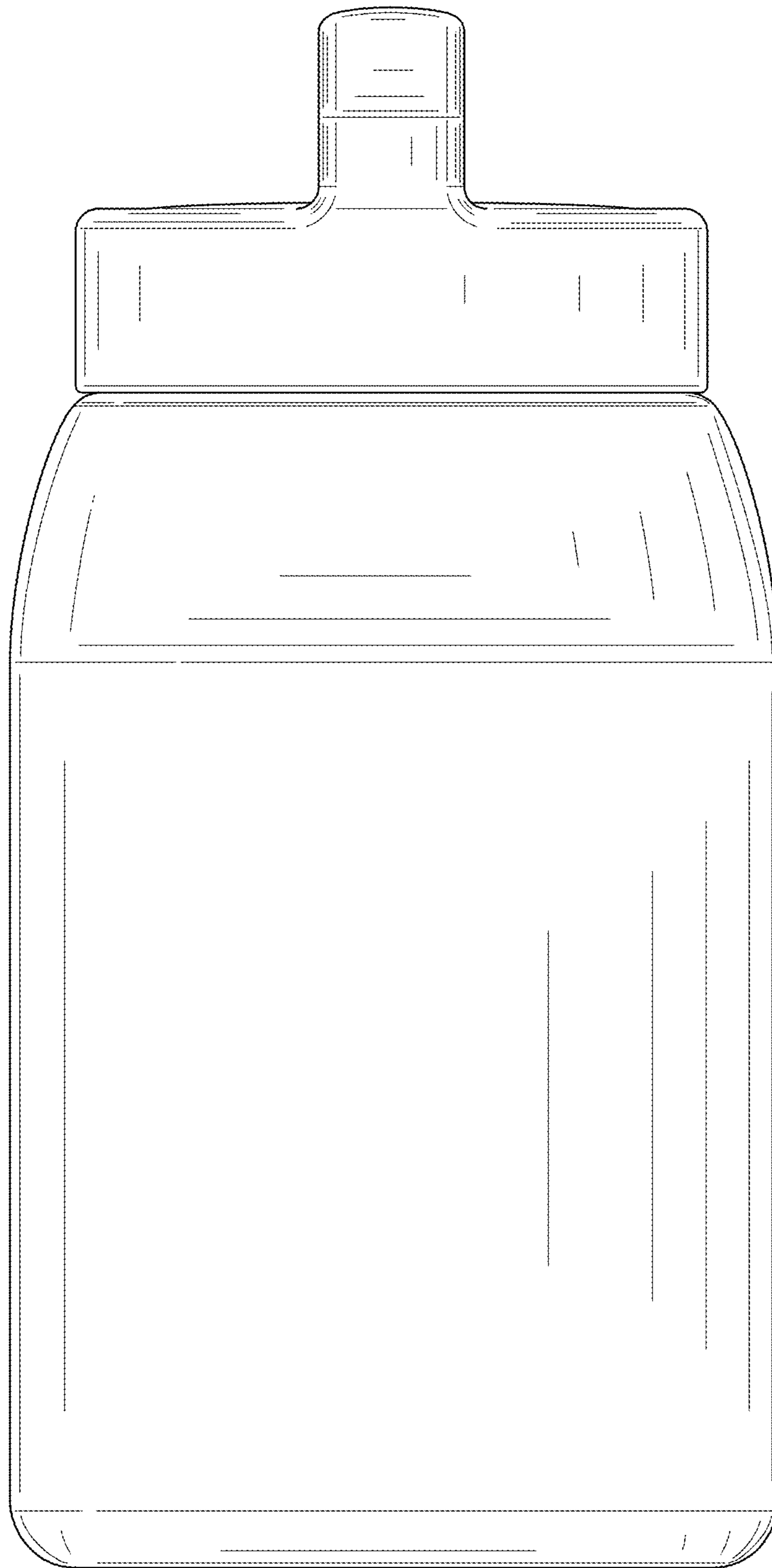


FIG. 9

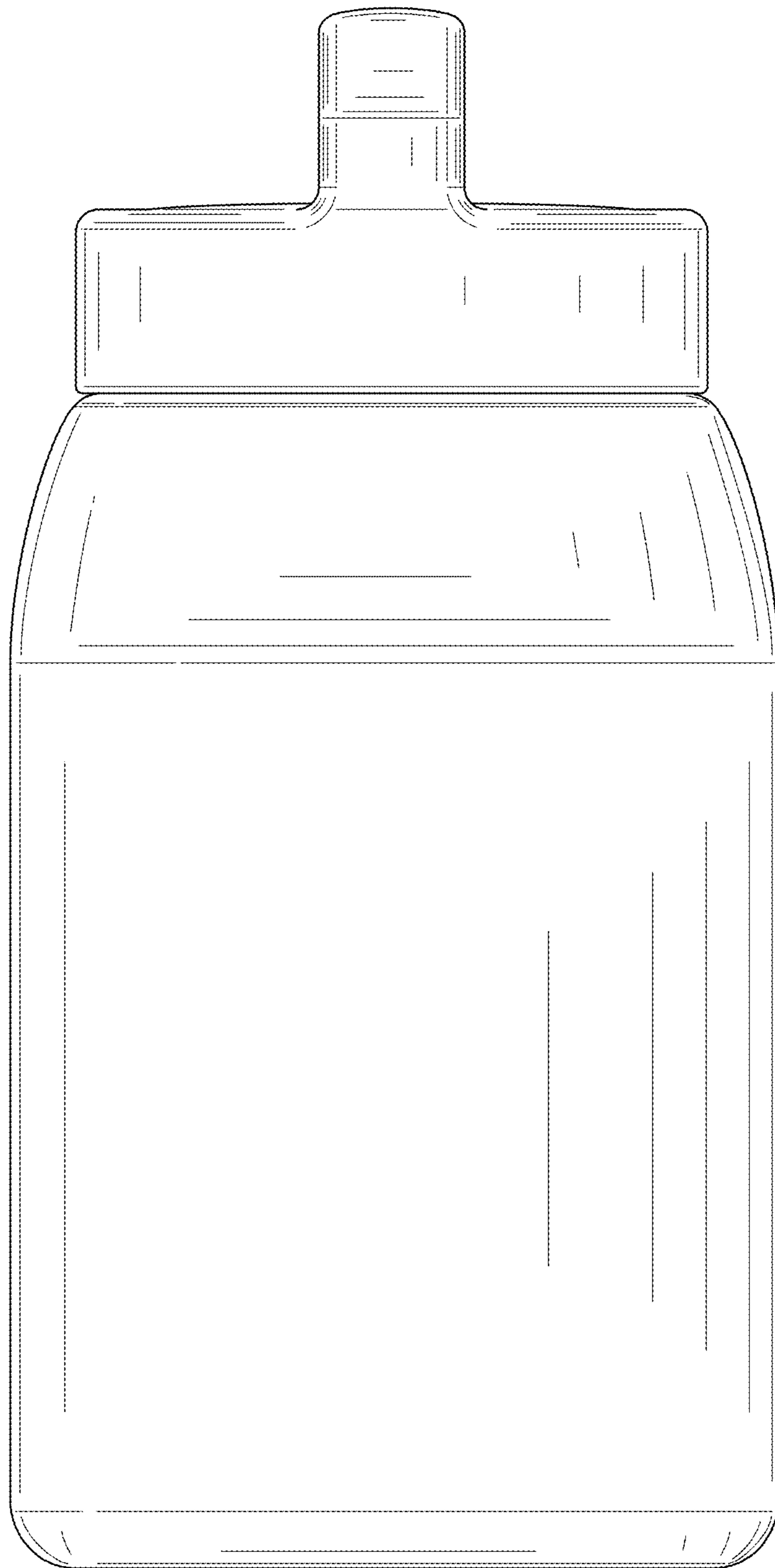


FIG. 10

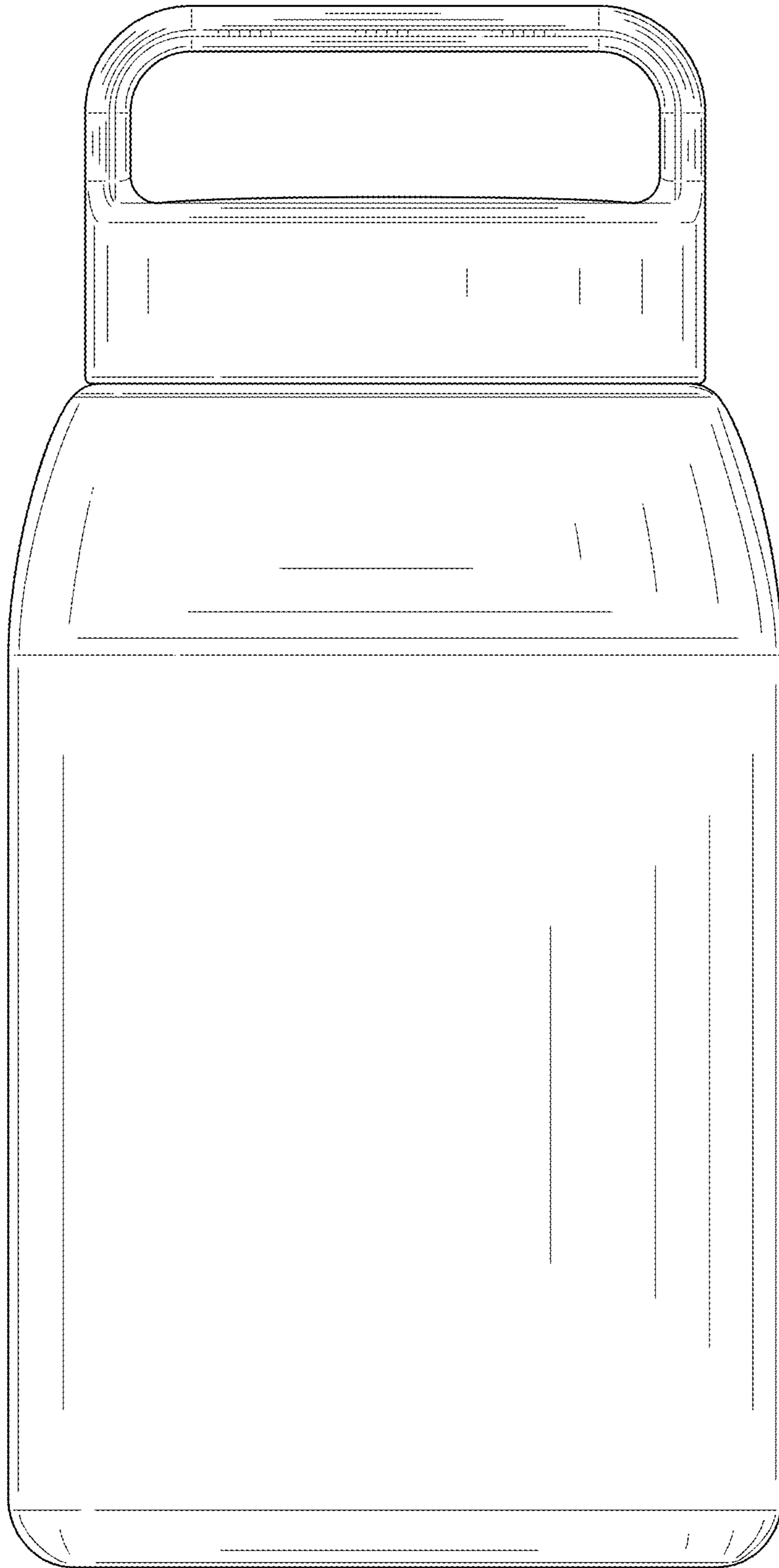


FIG. 11

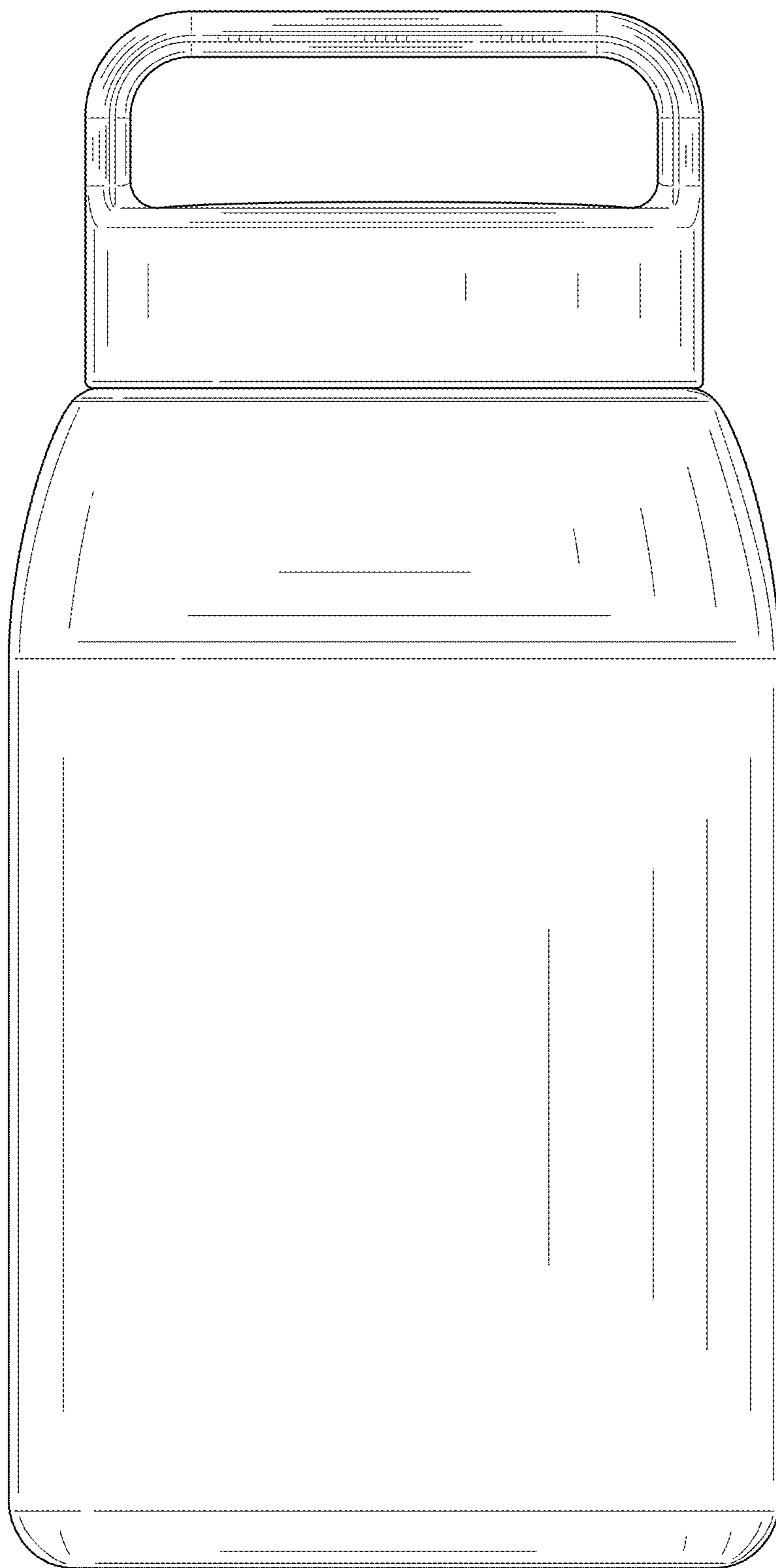


FIG. 12

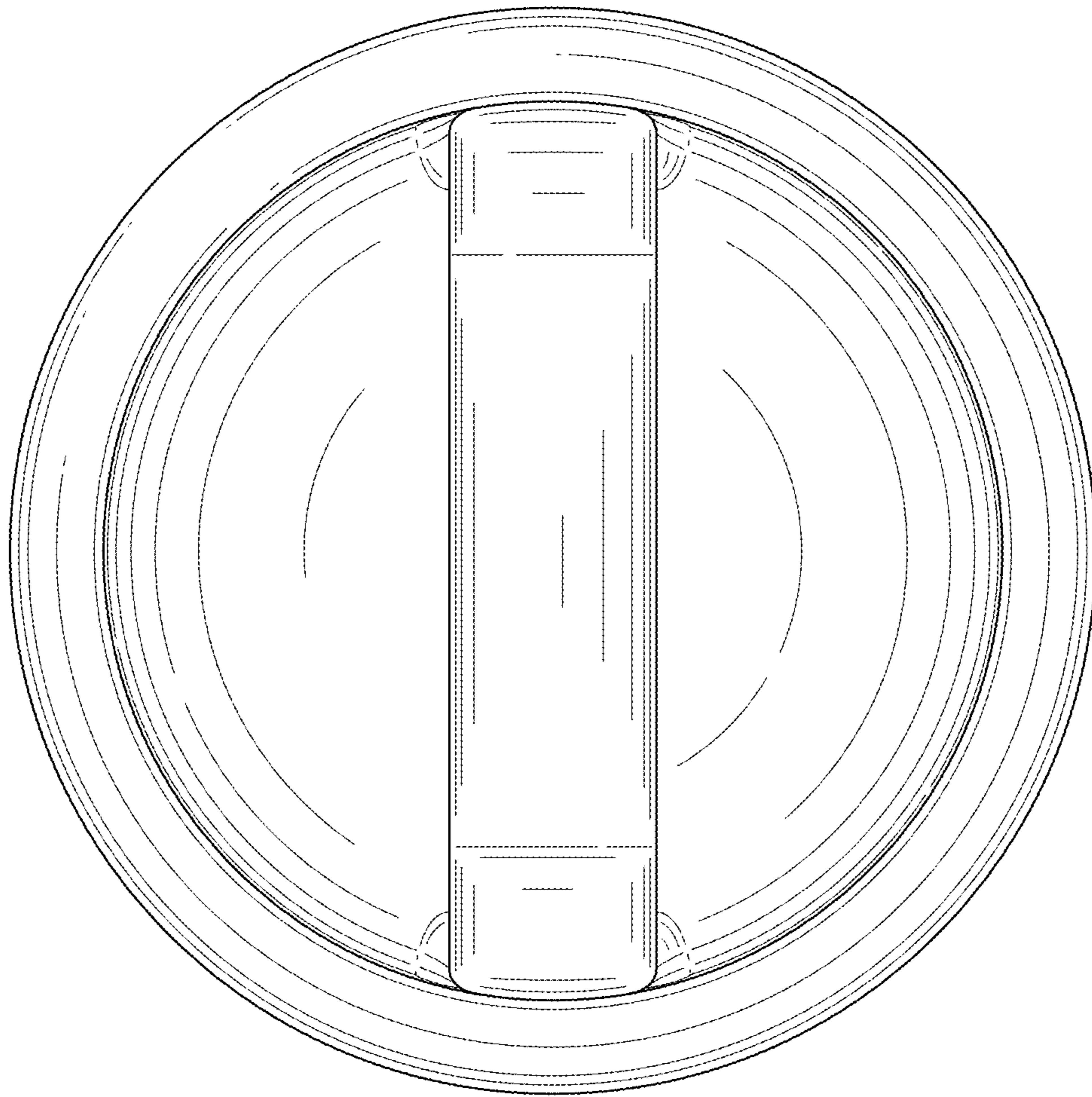
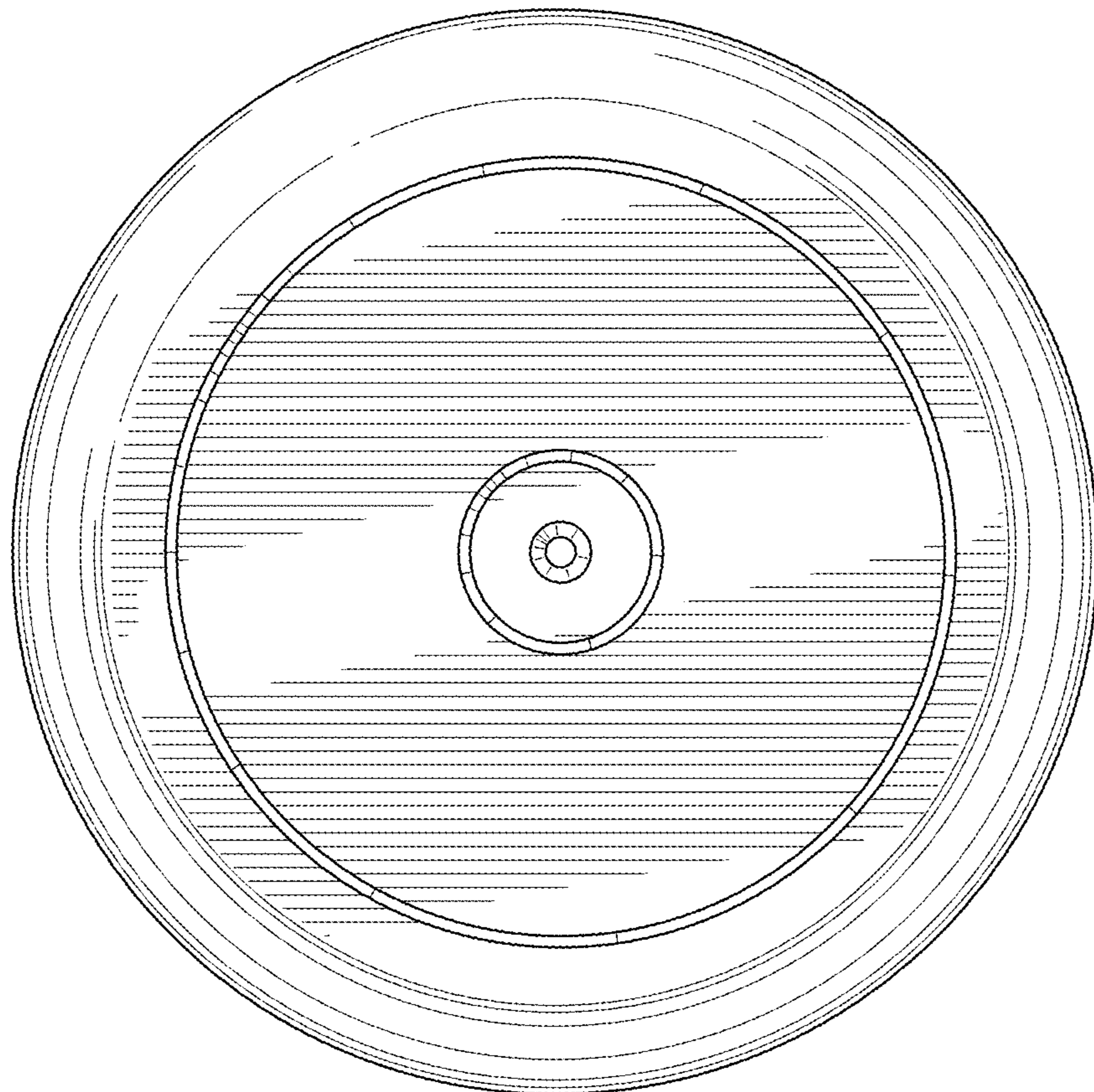


FIG. 13



**FIG. 14**



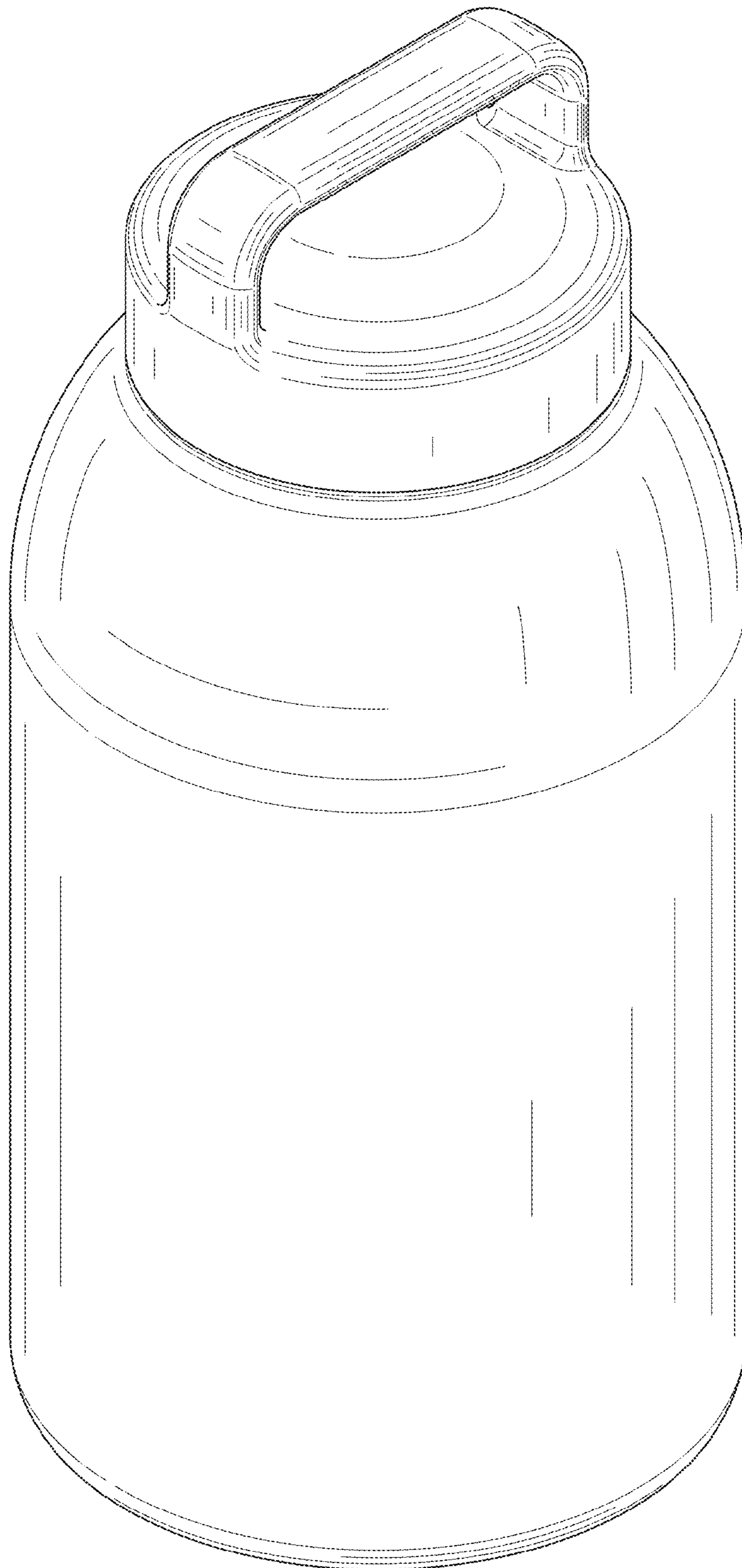


FIG. 15

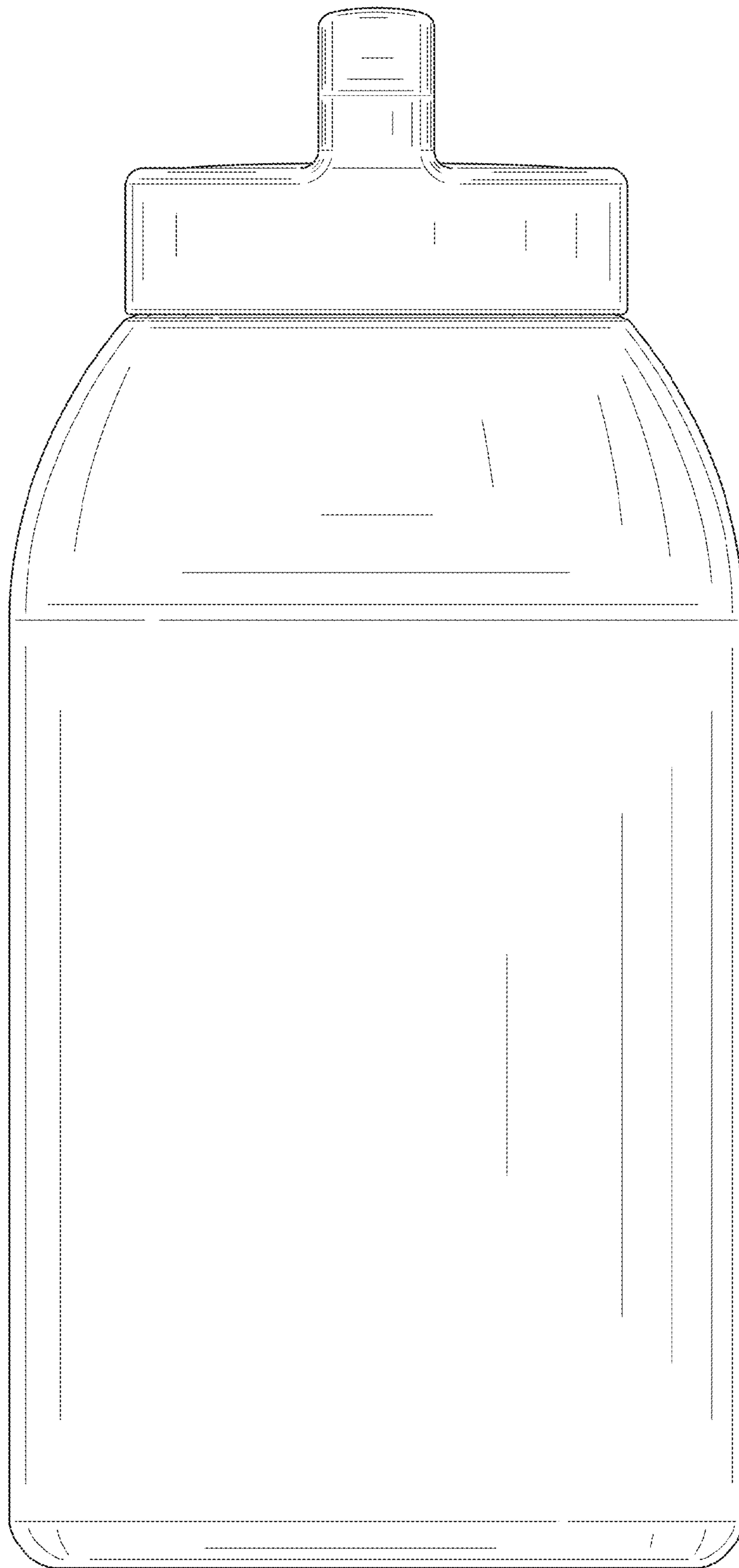


FIG. 16

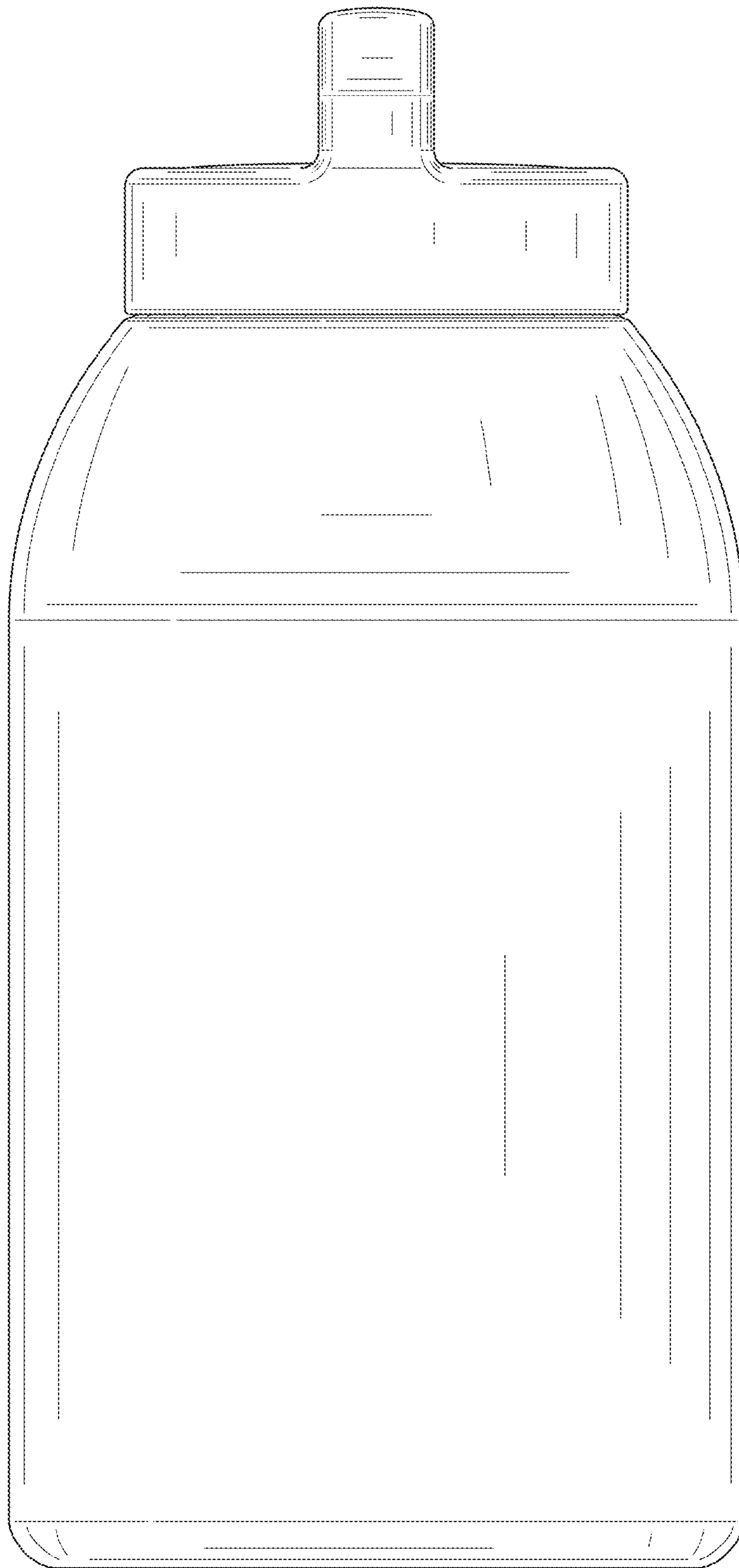


FIG. 17

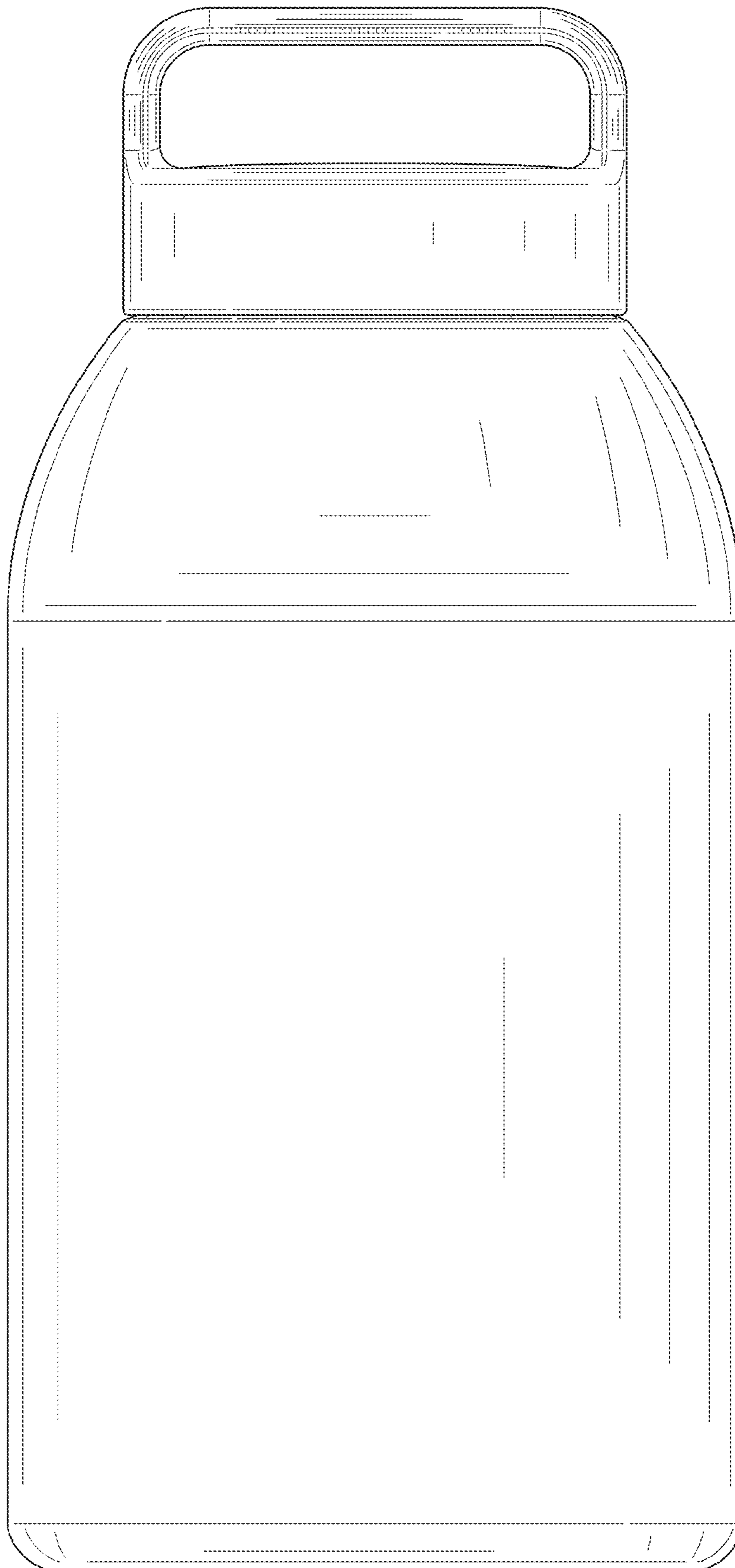


FIG. 18

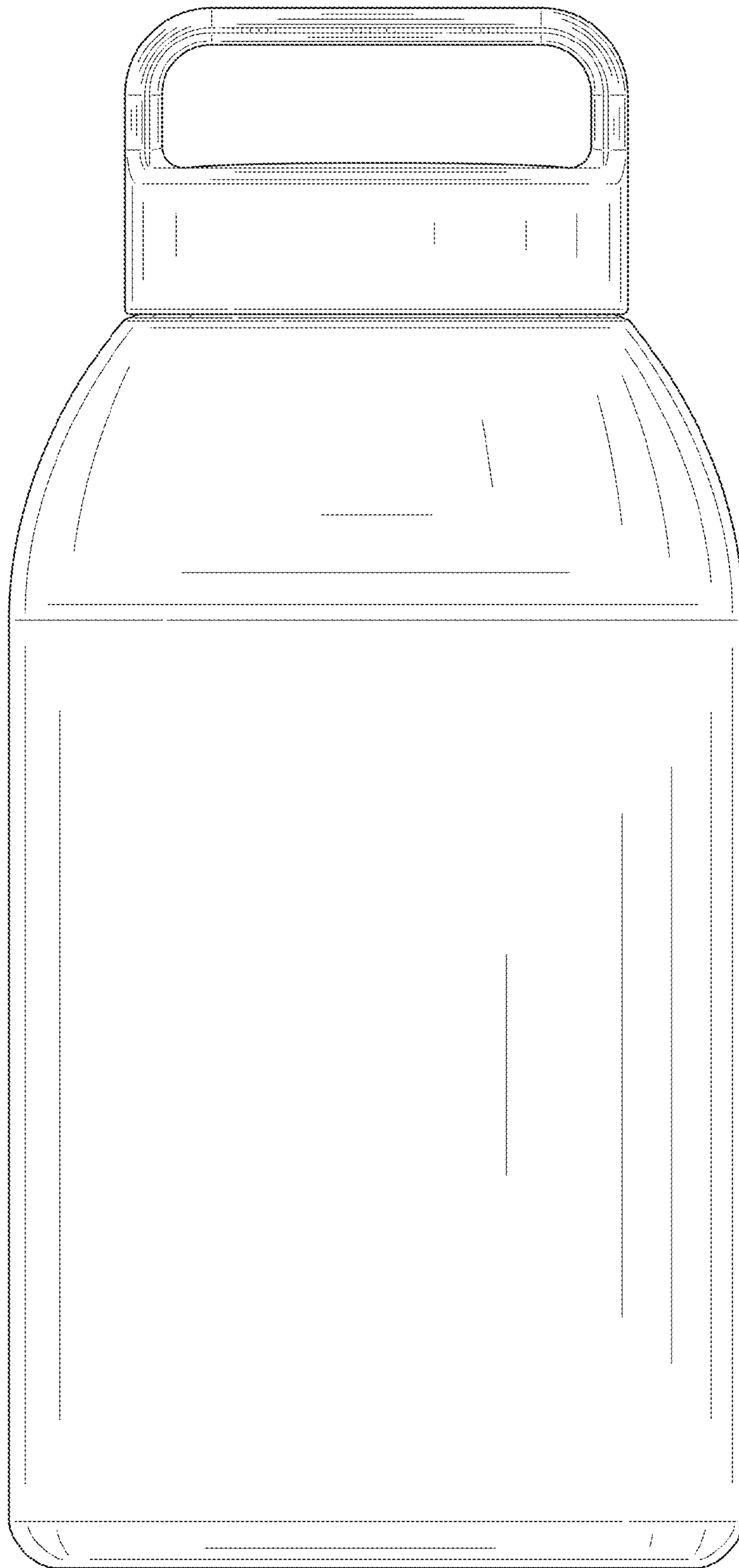


FIG. 19

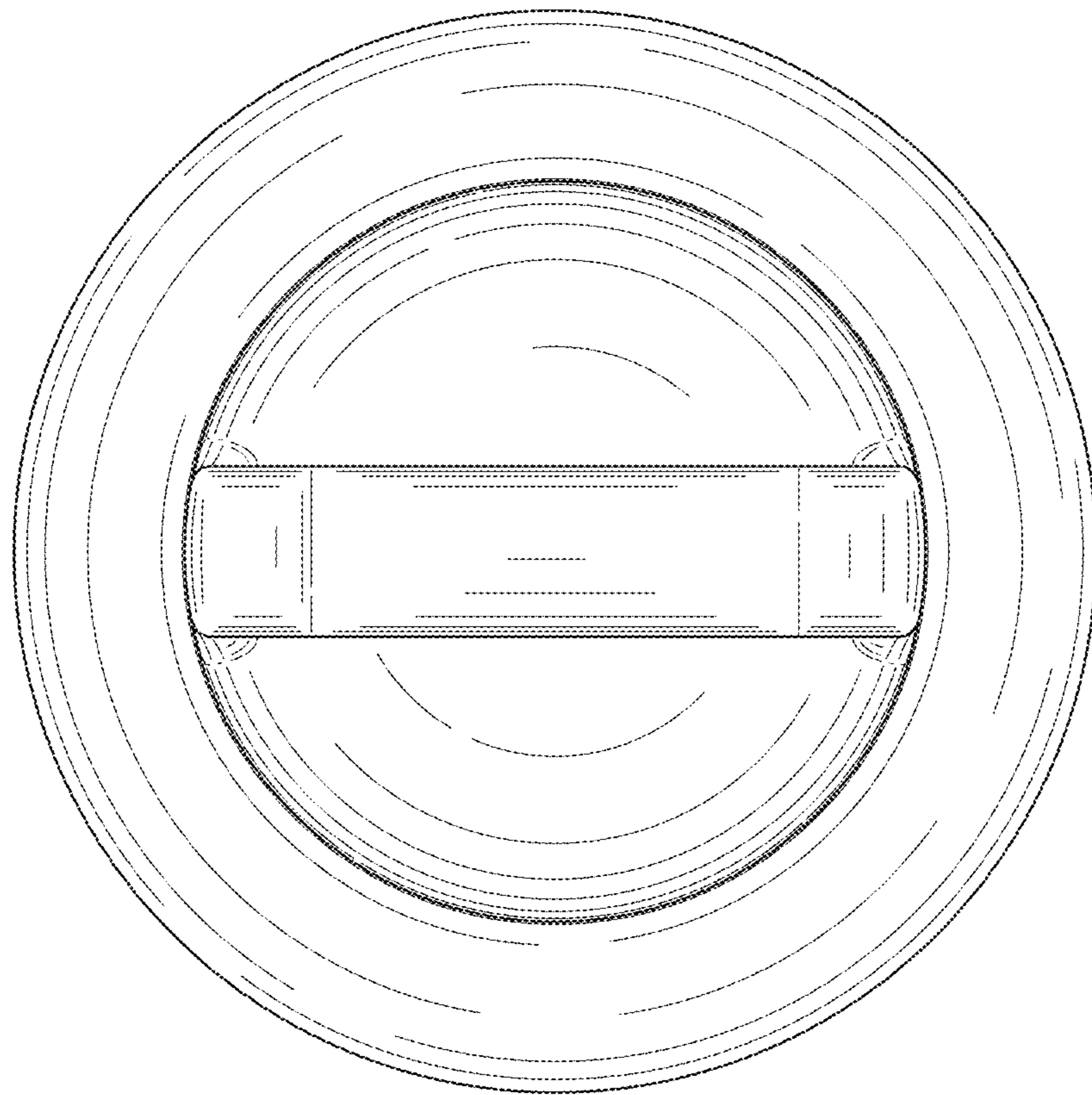


FIG. 20

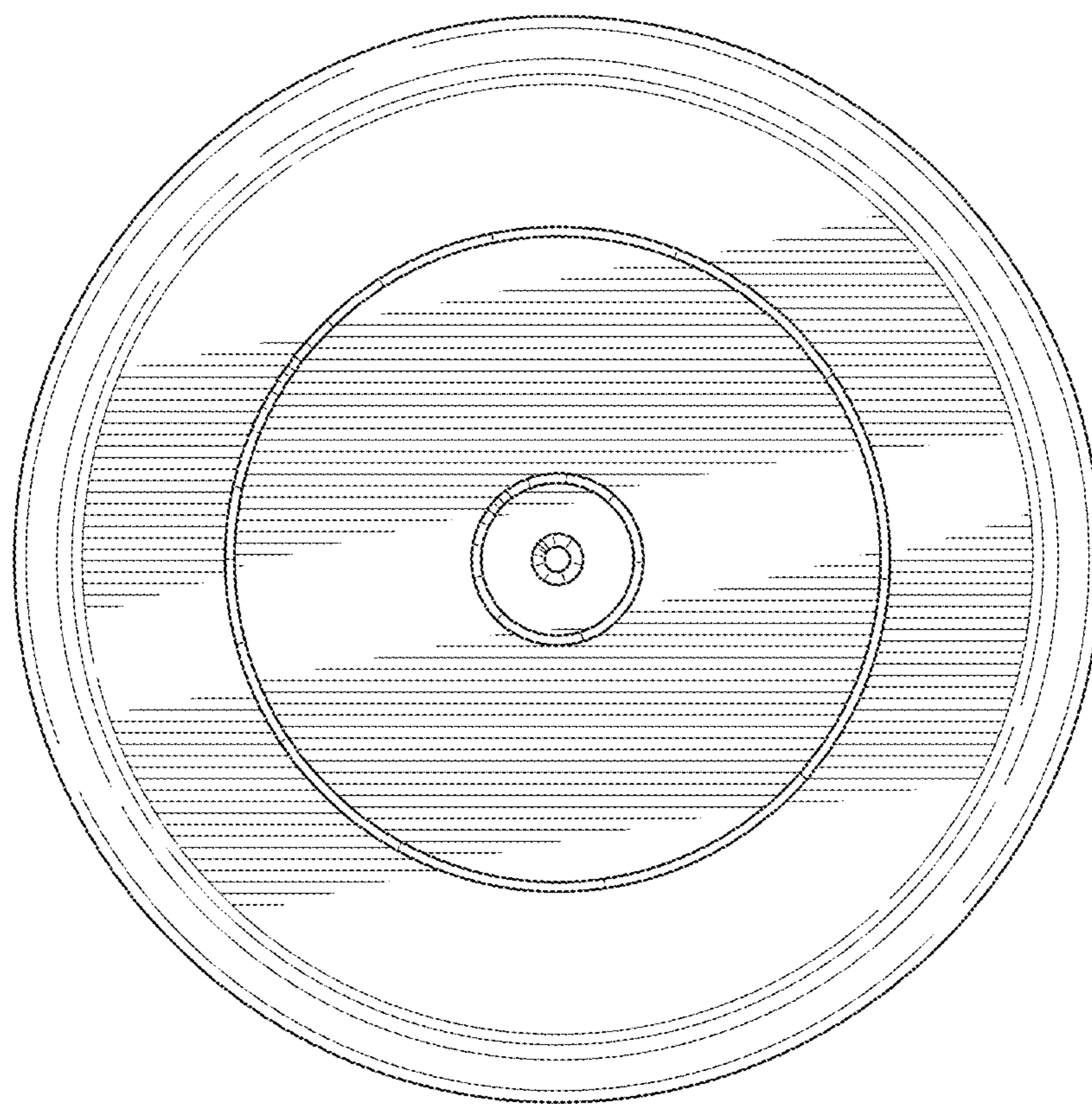


FIG. 21