



US00D932821S

(12) **United States Design Patent** (10) **Patent No.:** **US D932,821 S**
Wu (45) **Date of Patent:** **** Oct. 12, 2021**

(54) **TOASTER**
(71) Applicant: **SHENZHEN QIANHAI PATUOXUN NETWORK AND TECHNOLOGY CO., LTD**, Shenzhen (CN)
(72) Inventor: **Fafeng Wu**, Shenzhen (CN)
(73) Assignee: **SHENZHEN QIANHAI PATUOXUN NETWORK AND TECHNOLOGY CO., LTD**, Shenzhen (CN)

D765,456 S * 9/2016 Lee D7/330
D791,526 S * 7/2017 Rose et al.
D807,677 S * 1/2018 Ho D7/330
D814,223 S * 4/2018 Barquin D7/330
D838,132 S * 1/2019 Kowalewski D7/330
D838,534 S * 1/2019 Bodum
D843,769 S * 3/2019 Chen D7/330
D886,505 S * 6/2020 Thun D7/330
D886,506 S * 6/2020 Thun D7/330

(**) Term: **15 Years**

(21) Appl. No.: **29/754,986**

(22) Filed: **Oct. 16, 2020**

(51) **LOC (13) Cl.** **07-02**

(52) **U.S. Cl.**
USPC **D7/330**

(58) **Field of Classification Search**
USPC D7/323, 328-330, 390
CPC ... A21B 2/00; A47J 37/00; A47J 37/06; A47J 37/0611; A47J 37/08; A47J 37/0807; A47J 37/0814; A47J 37/0835; A47J 37/0842; A47J 37/085; A47J 37/0864; A47J 37/0878; A47J 37/0885; A47J 37/0892; F24C 15/10; F24C 15/102
See application file for complete search history.

(56) **References Cited**

U.S. PATENT DOCUMENTS

D460,655 S 7/2002 Piret
D492,536 S * 7/2004 Wong D7/330
D502,839 S * 3/2005 Cuffaro D7/330
D644,473 S * 9/2011 Pantaleo D7/330
D724,885 S * 3/2015 Kunz D7/330

OTHER PUBLICATIONS

IKICH Toaster 2 Slice, LCD Screen Stainless Steel Toaster. Date First Available on Amazon.com Jan. 16, 2020. <https://www.amazon.com/IKICH-Settings-Toasters-Stainless-Function/dp/B086W76R3C/ref> (Year: 2020).*

* cited by examiner

Primary Examiner — Ricky Pham

(57) **CLAIM**

The ornamental design for a toaster, as shown and described.

DESCRIPTION

FIG. 1 is a perspective view of a toaster showing my new design;
FIG. 2 is another perspective view thereof;
FIG. 3 is a front elevational view thereof;
FIG. 4 is a rear elevational view thereof;
FIG. 5 is a left side elevational view thereof;
FIG. 6 is a right side elevational view thereof;
FIG. 7 is a top plan view thereof; and,
FIG. 8 is a bottom plan view thereof.
The broken lines in the drawings depict portions of the toaster that form no part of the claimed design.

1 Claim, 8 Drawing Sheets

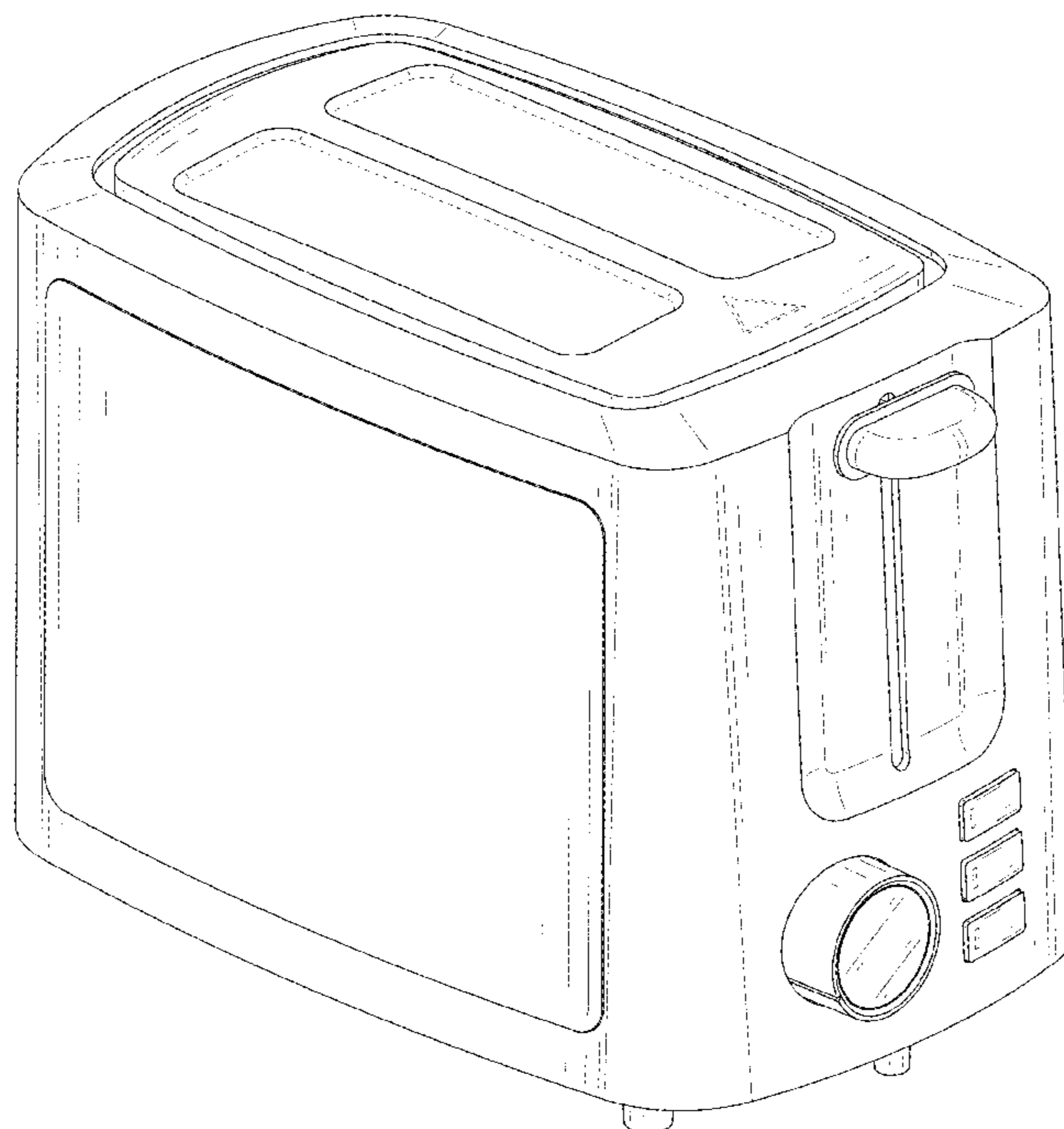

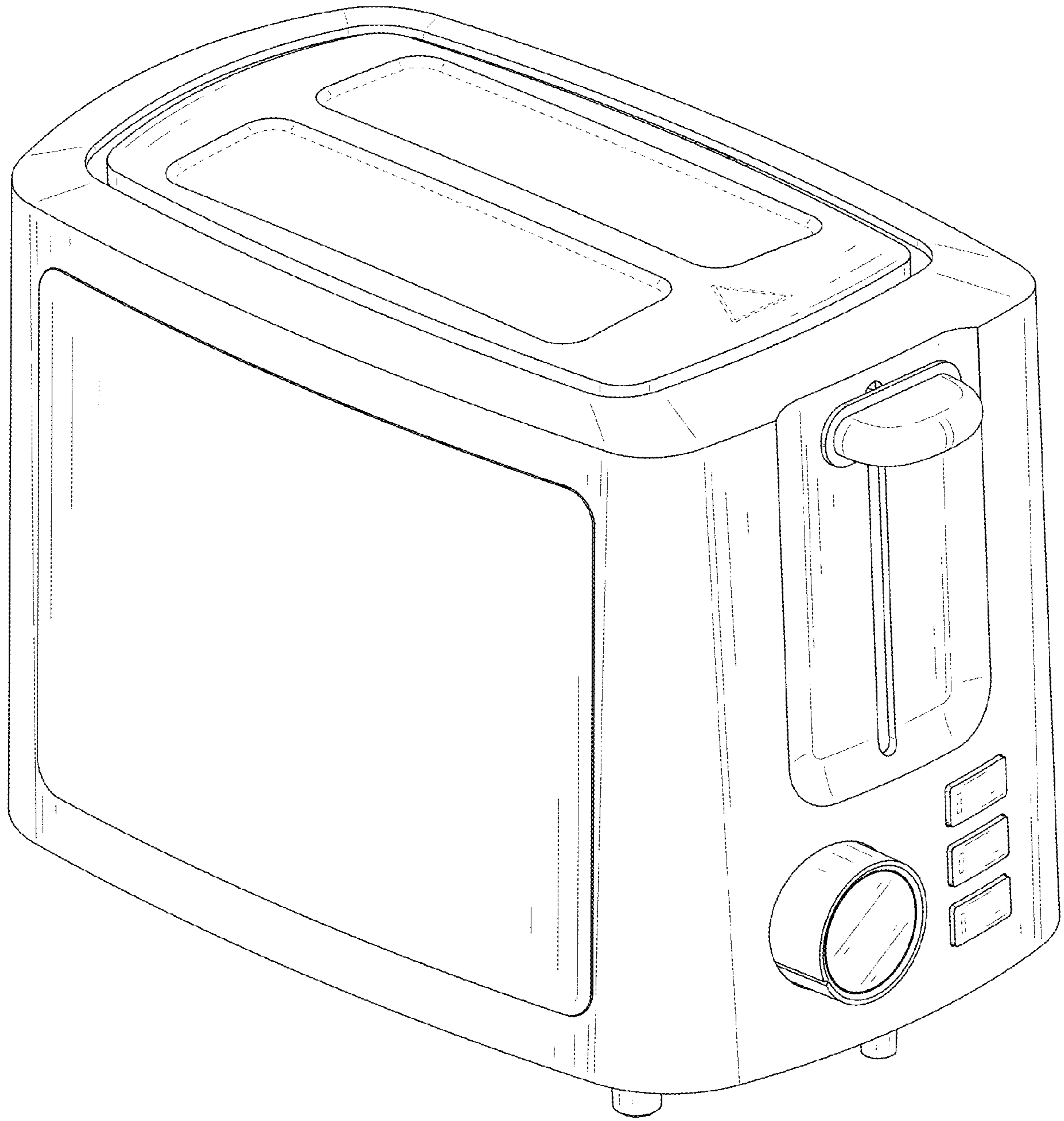

FIG. 1

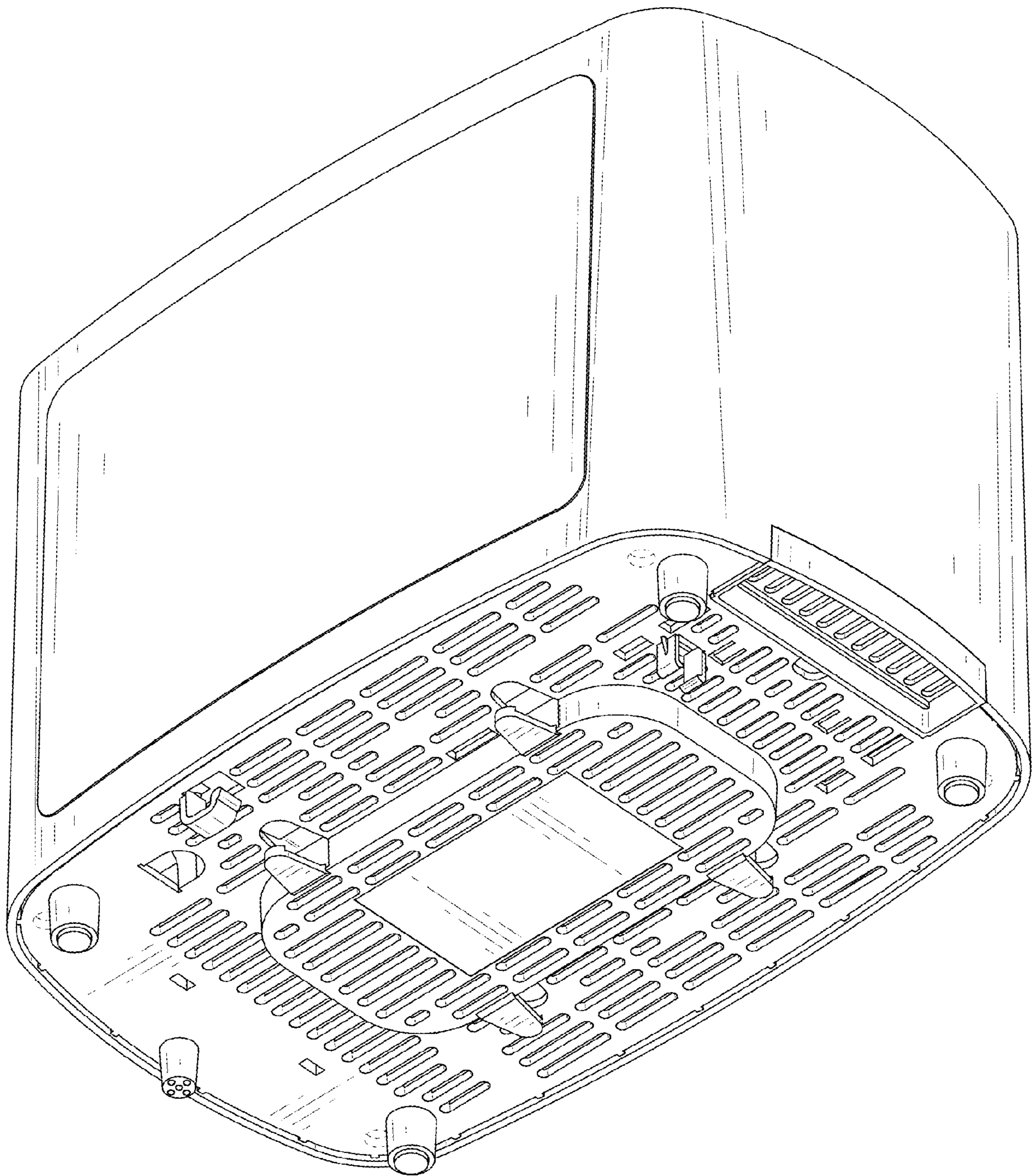

FIG. 2

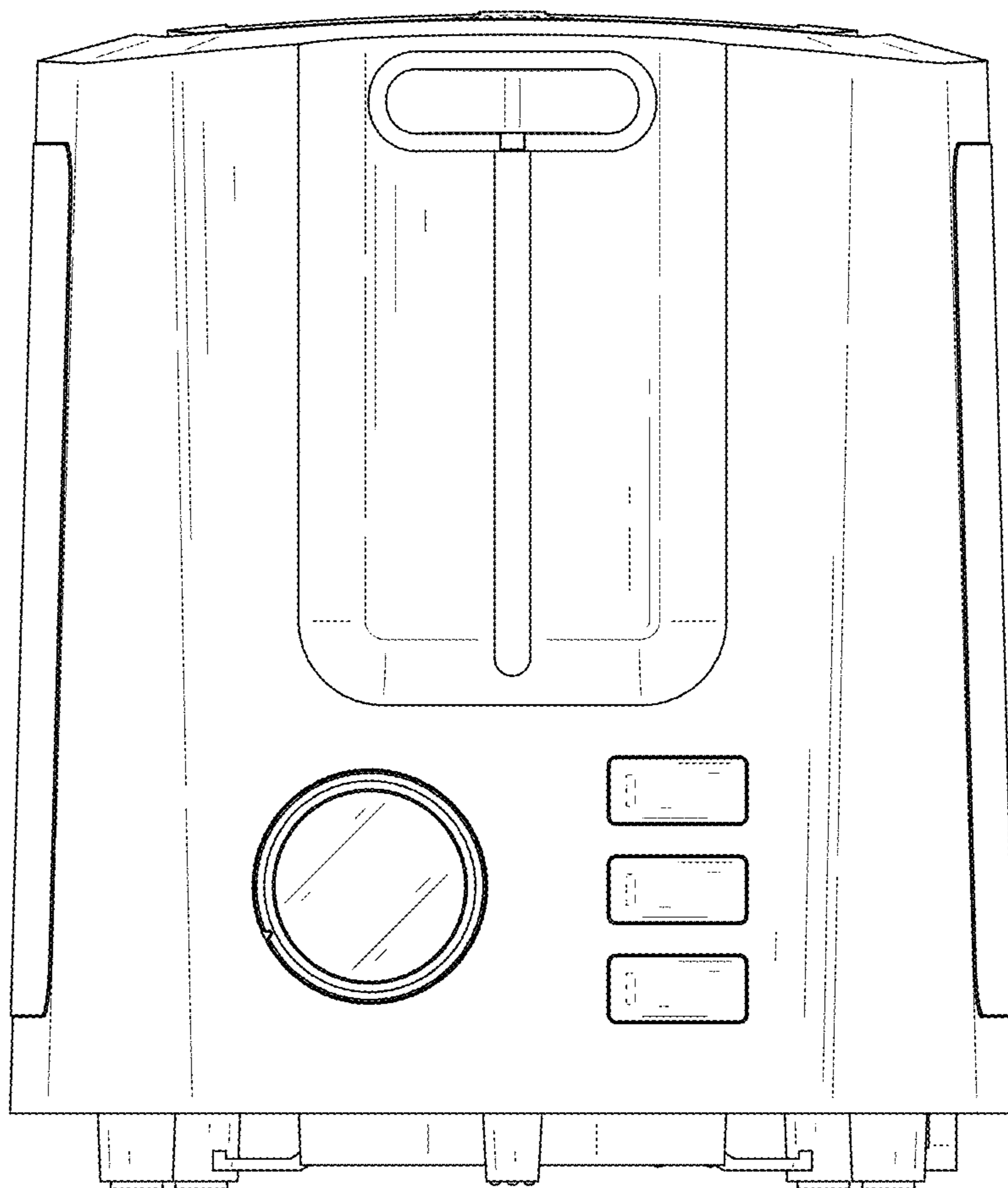

FIG. 3

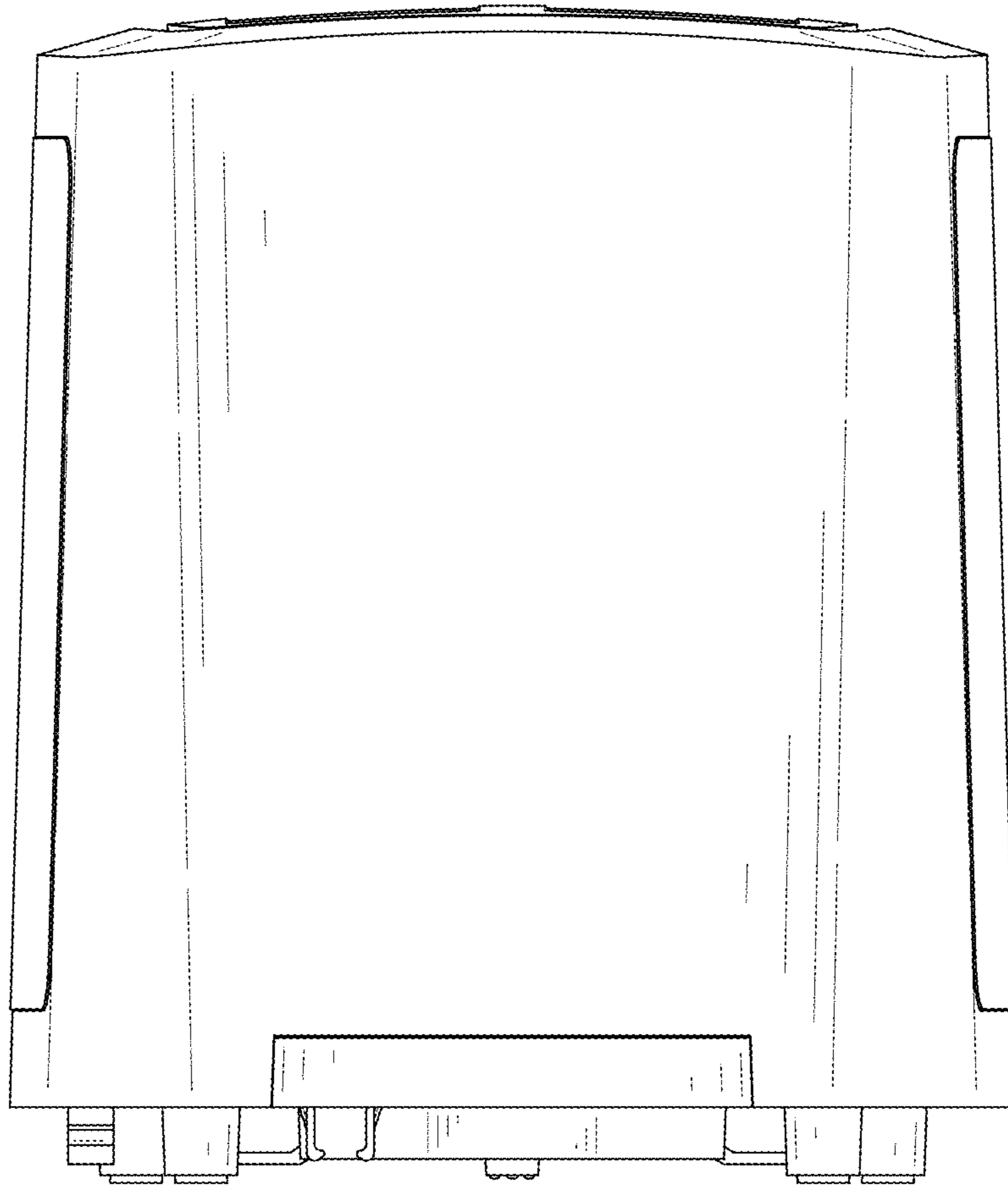

FIG. 4

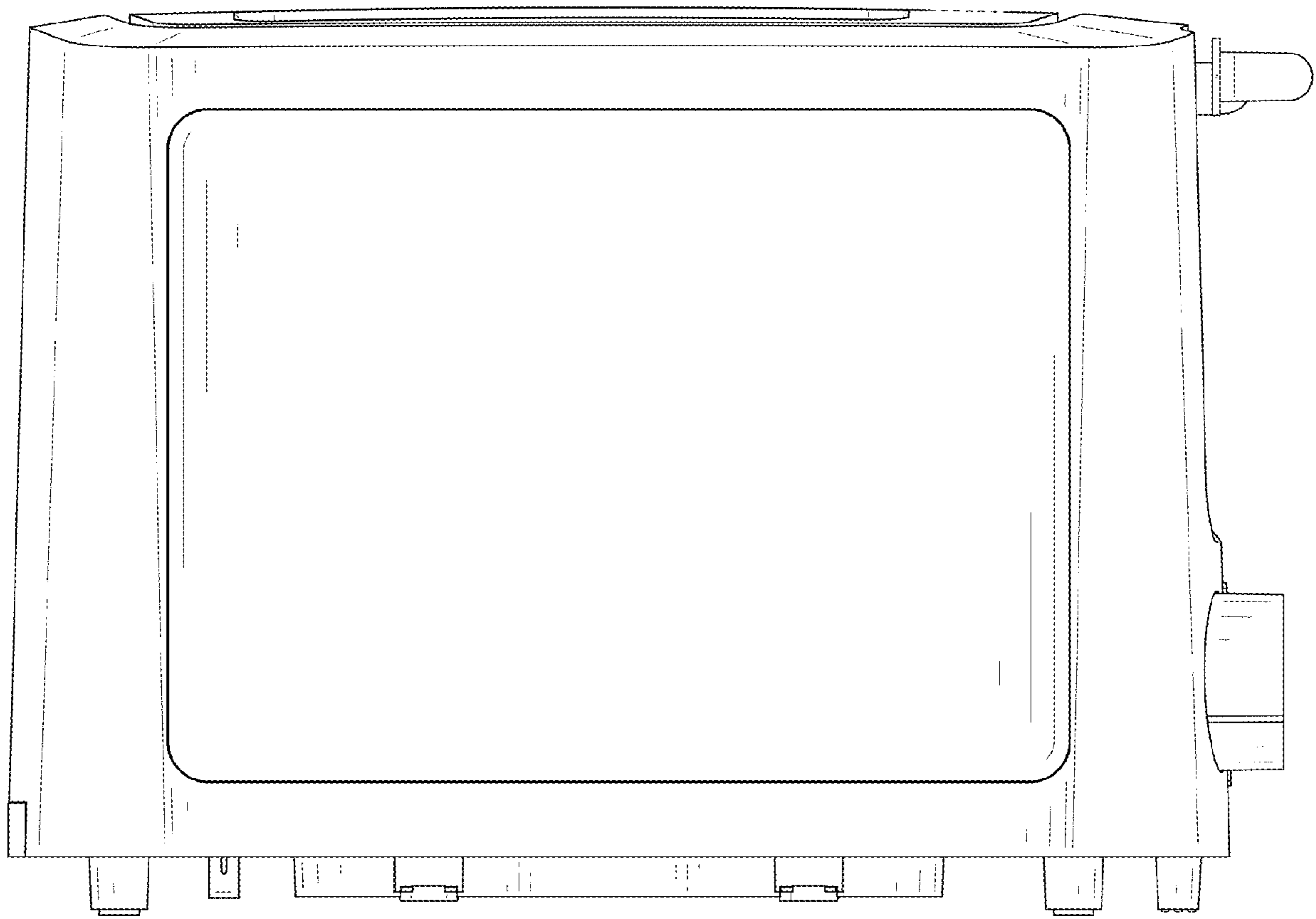

FIG. 5

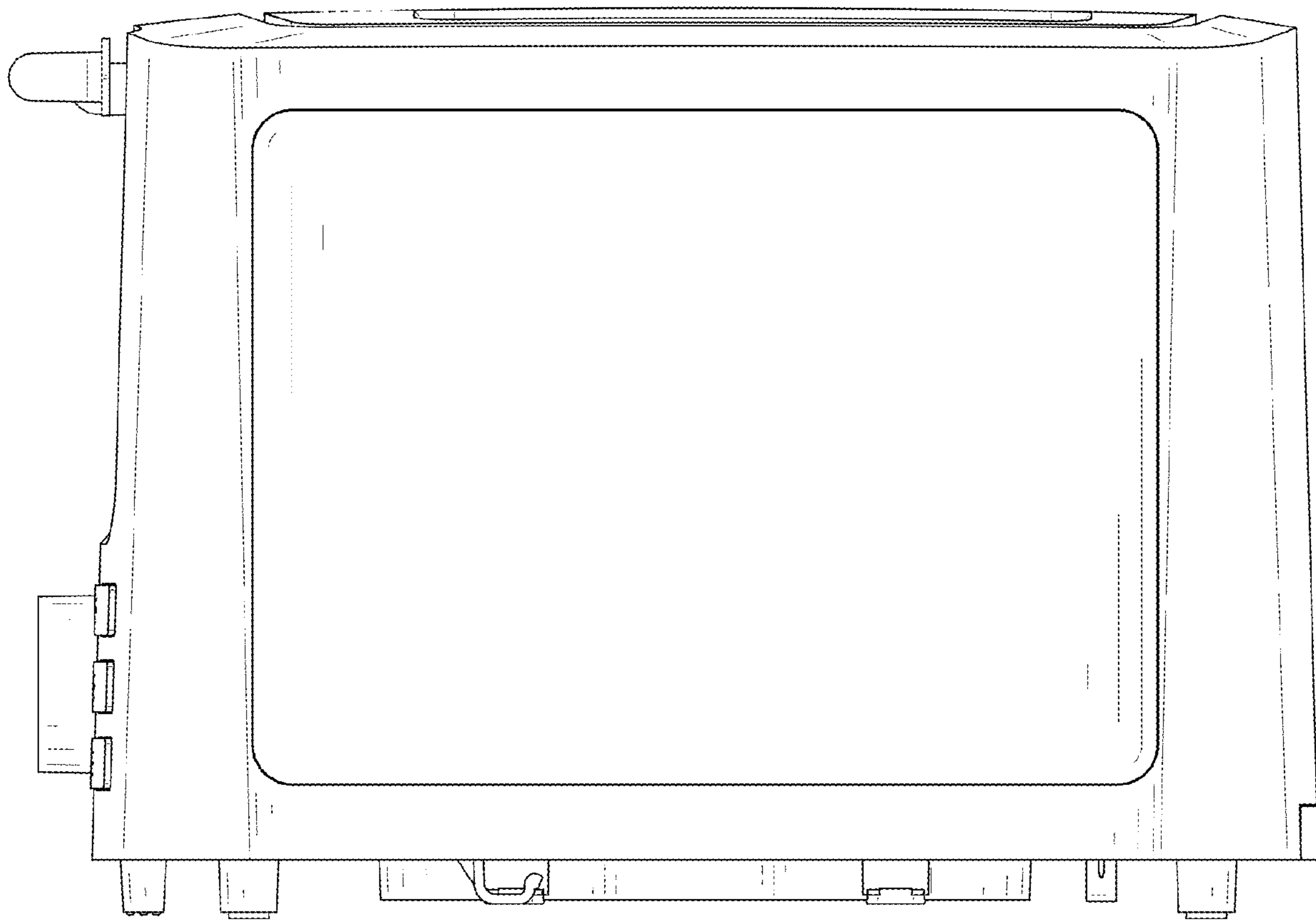

FIG. 6

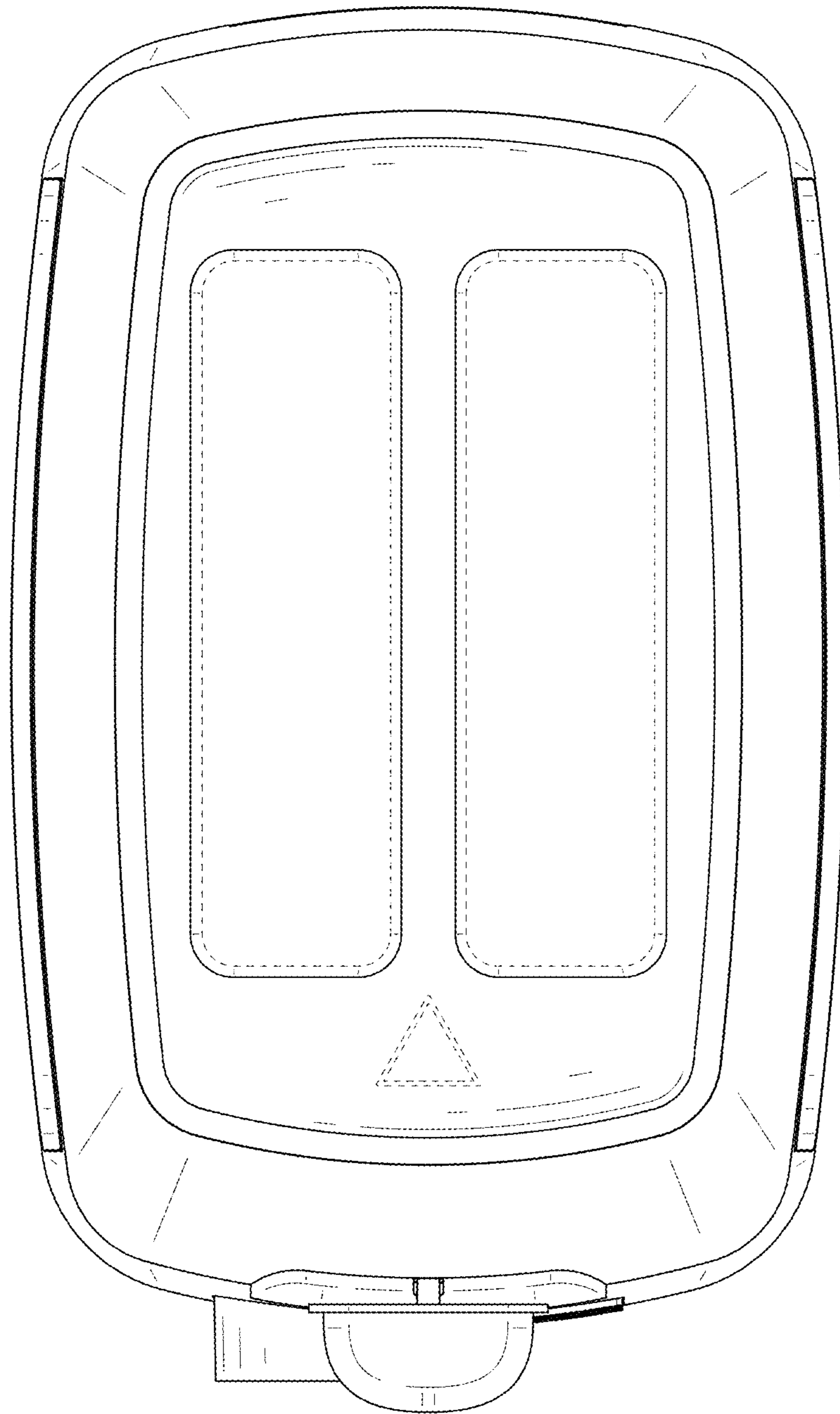

FIG. 7

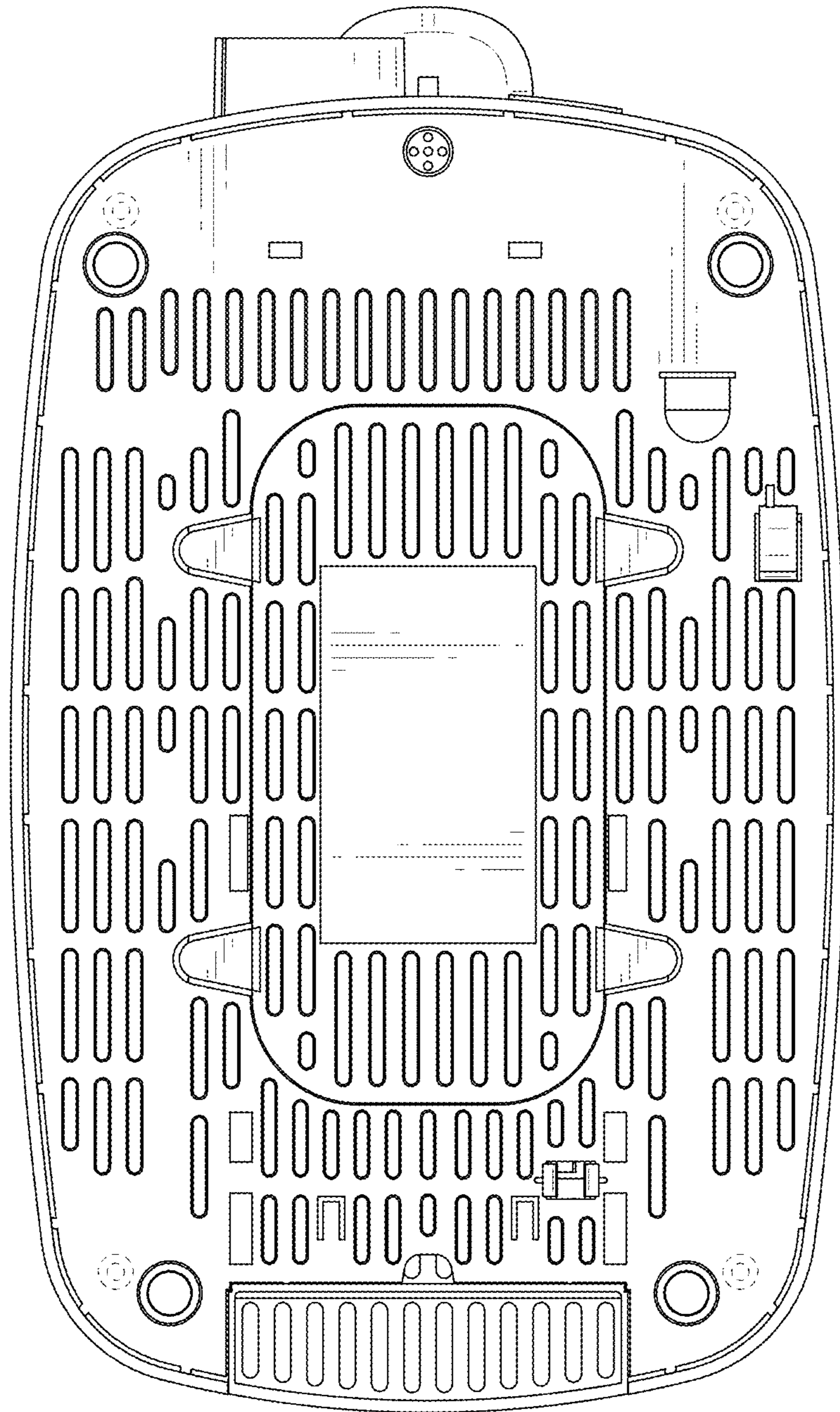

FIG. 8