



US00D932765S

(12) **United States Design Patent**  
**Li**

(10) **Patent No.:** **US D932,765 S**

(45) **Date of Patent:** **\*\* Oct. 12, 2021**

(54) **UMBRELLA BASE**

(71) Applicant: **Biyun Li**, Zhejiang (CN)

(72) Inventor: **Biyun Li**, Zhejiang (CN)

(\*\*) Term: **15 Years**

(21) Appl. No.: **29/766,730**

(22) Filed: **Jan. 18, 2021**

(51) **LOC (13) Cl.** ..... **03-03**

(52) **U.S. Cl.**  
USPC ..... **D3/10**

(58) **Field of Classification Search**  
USPC ..... D3/5, 10; D6/708.2, 708.15  
CPC ..... A47G 25/12; A47G 33/12; E04H 12/22;  
E04H 12/2269; E04H 12/2238

See application file for complete search history.

(56) **References Cited**

**U.S. PATENT DOCUMENTS**

- 4,591,126 A \* 5/1986 Berney ..... E04H 12/2246  
248/524
- D285,883 S \* 9/1986 Tegze ..... D3/10
- D286,116 S \* 10/1986 Tegze ..... D3/10
- D305,702 S \* 1/1990 Taliani ..... D3/10
- 5,354,031 A \* 10/1994 Bilotti ..... E04H 12/2238  
248/511
- 5,497,972 A \* 3/1996 Sofy ..... A47F 5/04  
248/523
- D447,649 S \* 9/2001 Mason ..... D6/708
- 6,446,930 B1 \* 9/2002 Li ..... E04H 12/2238  
135/15.1
- D470,305 S \* 2/2003 Clarke ..... D3/10
- D485,055 S \* 1/2004 Taylor ..... D3/10
- D487,163 S \* 2/2004 Humphrey ..... D26/142
- 6,755,311 B2 \* 6/2004 Berry ..... B25H 3/04  
211/65
- D495,536 S \* 9/2004 Lucht ..... D6/708
- D516,297 S \* 3/2006 Smith ..... D3/10
- D550,950 S \* 9/2007 Vanderminden ..... D3/10
- D568,603 S \* 5/2008 Smith ..... D3/10
- D573,786 S \* 7/2008 Smith ..... D3/10
- 7,614,600 B1 \* 11/2009 Smith ..... G09F 23/00  
135/16

- D609,899 S \* 2/2010 Lai ..... D3/10
- 7,784,761 B2 \* 8/2010 Ma ..... E04H 12/2246  
248/523
- D641,435 S \* 7/2011 Coote ..... D21/694
- D697,705 S \* 1/2014 Ma ..... D3/10

(Continued)

**OTHER PUBLICATIONS**

Doifun Patio Umbrella Stand, amazon.com, [https://www.amazon.com/dp/B09161KJBZ/ref=sspa\\_dk\\_detail\\_2?pd\\_rd\\_i=B09161C2X5&pd\\_rd\\_w=sai58&pf\\_rd\\_p=887084a2-5c34-4113-a4f8-b7947847c308&pd\\_rd\\_wg=07mw5&pf\\_rd\\_r=7H1VHBP0BR799KVR9QRR&pd\\_rd\\_r=c9a6a3f9-e4a6-4105-ac8e-018cece9acd&spLa=ZW5jcnlwdGVkUXVhbGlmaWVyPUEyMEVUVDBYVVM0U0pSJMmVuY3J5cHRIZEikPUEwMDAwMDE2MzRYRFpVSzYwRFczUCZlbnNyeXB0ZW50ZWRBZEikPUEwMzU4MDYzMDURUNUJKRIJGUIBXOSZ3aWRnZXROYWlIPXNwX2RldGFpbCZlY3Rpb249Y2xpY2tSZWRpcmVjdCZkb05vdExvZ0NsaWNrPXRydWU&th=1](https://www.amazon.com/dp/B09161KJBZ/ref=sspa_dk_detail_2?pd_rd_i=B09161C2X5&pd_rd_w=sai58&pf_rd_p=887084a2-5c34-4113-a4f8-b7947847c308&pd_rd_wg=07mw5&pf_rd_r=7H1VHBP0BR799KVR9QRR&pd_rd_r=c9a6a3f9-e4a6-4105-ac8e-018cece9acd&spLa=ZW5jcnlwdGVkUXVhbGlmaWVyPUEyMEVUVDBYVVM0U0pSJMmVuY3J5cHRIZEikPUEwMDAwMDE2MzRYRFpVSzYwRFczUCZlbnNyeXB0ZW50ZWRBZEikPUEwMzU4MDYzMDURUNUJKRIJGUIBXOSZ3aWRnZXROYWlIPXNwX2RldGFpbCZlY3Rpb249Y2xpY2tSZWRpcmVjdCZkb05vdExvZ0NsaWNrPXRydWU&th=1) (Year: 2021).\*

(Continued)

*Primary Examiner* — Steven J Czyz  
 (74) *Attorney, Agent, or Firm* — ScienBiziP, P.C.

(57) **CLAIM**

The ornamental design for an umbrella base, as shown and described.

**DESCRIPTION**

FIG. 1 is a front, right, and top perspective view of an umbrella base, showing my design.  
 FIG. 2 is a rear, left, and bottom perspective view thereof.  
 FIG. 3 is a front elevation view thereof.  
 FIG. 4 is a rear elevation view thereof.  
 FIG. 5 is a left side elevation view thereof.  
 FIG. 6 is a right side elevation view thereof.  
 FIG. 7 is a top plan view thereof; and,  
 FIG. 8 is a bottom plan view thereof.  
 The broken lines shown in the drawings are included for the purpose of illustrating portions of the umbrella base that form no part of the claimed design.

**1 Claim, 8 Drawing Sheets**

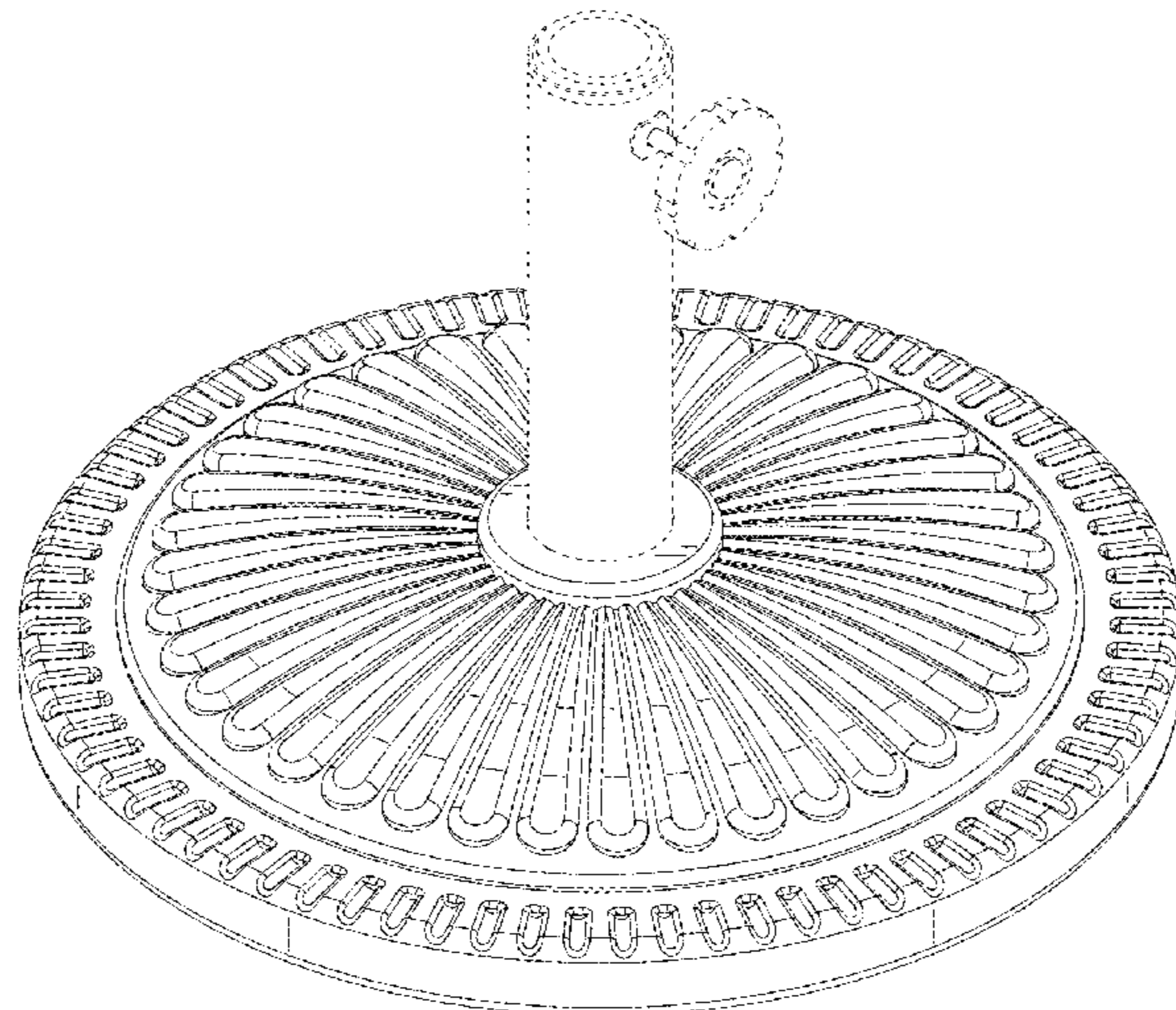

(56)

References Cited

U.S. PATENT DOCUMENTS

8,632,045 B2 \* 1/2014 Ma ..... A45B 23/00  
248/519  
D724,309 S \* 3/2015 Ma ..... D3/10  
D732,817 S \* 6/2015 Elstow ..... D3/10  
D740,546 S \* 10/2015 DeVaney ..... D3/10  
9,200,655 B2 \* 12/2015 Pan ..... F16B 9/056  
D752,335 S \* 3/2016 Stedman ..... D3/10  
9,376,832 B2 \* 6/2016 Deering ..... E04F 11/1865  
D768,978 S \* 10/2016 Ma ..... D3/10  
9,463,850 B2 \* 10/2016 Lovett ..... A43B 7/144  
D771,935 S \* 11/2016 Ma ..... D3/10  
D775,461 S \* 1/2017 Ma ..... D3/10  
D817,631 S \* 5/2018 Weng ..... D3/10  
10,017,955 B2 \* 7/2018 Ye ..... A45B 11/00  
10,100,969 B1 \* 10/2018 Zhu ..... B62B 5/04  
D833,023 S \* 11/2018 Maletic ..... D24/186  
D833,136 S \* 11/2018 Ma ..... D3/10  
D855,967 S \* 8/2019 Ma ..... D3/10  
D866,949 S \* 11/2019 Siegenthaler ..... D3/10  
D868,449 S \* 12/2019 Siegenthaler ..... D3/10  
D876,811 S \* 3/2020 Vanderminden ..... D3/10  
2003/0111657 A1 \* 6/2003 Green ..... E01F 9/692  
256/45  
2004/0069922 A1 \* 4/2004 Wu ..... E04H 12/2246  
248/519  
2006/0054206 A1 \* 3/2006 Bilotti ..... E04H 12/2238  
135/16  
2007/0080277 A1 \* 4/2007 Chen ..... E04H 15/28  
248/354.3  
2011/0232704 A1 \* 9/2011 Li ..... F16M 13/02  
135/16

OTHER PUBLICATIONS

Upivitle Patio Umbrella Stand, amazon.com, [https://www.amazon.com/dp/B097DM4VVZ/ref=sspa\\_dk\\_detail\\_6?psc=1&pd\\_rd\\_i=B097DM4VVZ&pd\\_rd\\_w=P4aZ6&pf\\_rd\\_p=887084a2-5c34-4113-a4f8-b7947847c308&pd\\_rd\\_wg=vp4hS&pf\\_rd\\_r=K5P2V6951V1EJ78KF9ZR&pd\\_rd\\_r=c51df6de-ad8c-44d1-8666-62c7795c0dcc&spLa=ZW5jcnlwdGVkUXVhbGlmaWVyPUFaMU NMRVE0TEcxM04mZW5jcnlwdGVkSWQ9QTAYMTI0NDFWNz JVSknVNMkhQQzEmZW5jcnlwdGVkQWRJZD1BMDUwNzA5O TFXtKpVRVc4NENYUTQmd2lkZ2V0TmFtZT1zcF9kZXRhaWw mYWN0aW9uPWNsaWNrUmVkaXJlY3QmZG9Ob3RMb2dDbG ljaz10cnVI](https://www.amazon.com/dp/B097DM4VVZ/ref=sspa_dk_detail_6?psc=1&pd_rd_i=B097DM4VVZ&pd_rd_w=P4aZ6&pf_rd_p=887084a2-5c34-4113-a4f8-b7947847c308&pd_rd_wg=vp4hS&pf_rd_r=K5P2V6951V1EJ78KF9ZR&pd_rd_r=c51df6de-ad8c-44d1-8666-62c7795c0dcc&spLa=ZW5jcnlwdGVkUXVhbGlmaWVyPUFaMU NMRVE0TEcxM04mZW5jcnlwdGVkSWQ9QTAYMTI0NDFWNz JVSknVNMkhQQzEmZW5jcnlwdGVkQWRJZD1BMDUwNzA5O TFXtKpVRVc4NENYUTQmd2lkZ2V0TmFtZT1zcF9kZXRhaWw mYWN0aW9uPWNsaWNrUmVkaXJlY3QmZG9Ob3RMb2dDbG ljaz10cnVI) (Year: 2021).\*

Fruiteam Patio Umbrella Stand, amazon.com, [https://www.amazon.com/dp/B08PNWR9Y2/ref=sspa\\_dk\\_detail\\_4?pd\\_rd\\_i=B08PNWR9Y2&pd\\_rd\\_w=P4aZ6&pf\\_rd\\_p=887084a2-5c34-4113-a4f8-b7947847c308&pd\\_rd\\_wg=vp4hS&pf\\_rd\\_r=K5P2V6951V1EJ78KF9ZR&pd\\_rd\\_r=c51df6de-ad8c-44d1-8666-62c7795c0dcc&spLa=ZZW5jcnlwdGVkUXVhbGlmaWVyPUEzUVpDTDhXRzFGRURTJmVuY3J5cH RIZEIkPUExMDE1NzY2MTU2ODJPNDhYM0w3TSZlbnNyeX B0ZWRBZEIkPUExODQ0Mzg3M0gwTVFaN1RFRjJmRyZ3aW RnZXROYW1lPXNwX2RldGFpbCZlY3Rpb249Y2xpY2tSZWRp cmVjdCZkb05vdExvZ0NsaWNrPXRydWU&th=1](https://www.amazon.com/dp/B08PNWR9Y2/ref=sspa_dk_detail_4?pd_rd_i=B08PNWR9Y2&pd_rd_w=P4aZ6&pf_rd_p=887084a2-5c34-4113-a4f8-b7947847c308&pd_rd_wg=vp4hS&pf_rd_r=K5P2V6951V1EJ78KF9ZR&pd_rd_r=c51df6de-ad8c-44d1-8666-62c7795c0dcc&spLa=ZZW5jcnlwdGVkUXVhbGlmaWVyPUEzUVpDTDhXRzFGRURTJmVuY3J5cH RIZEIkPUExMDE1NzY2MTU2ODJPNDhYM0w3TSZlbnNyeX B0ZWRBZEIkPUExODQ0Mzg3M0gwTVFaN1RFRjJmRyZ3aW RnZXROYW1lPXNwX2RldGFpbCZlY3Rpb249Y2xpY2tSZWRp cmVjdCZkb05vdExvZ0NsaWNrPXRydWU&th=1) (Year: 2021).\*

Hooyeatlin HDPE Umbrella Stand, amazon.com, [https://www.amazon.com/Umbrella-Stand-Market-Outdoor-Holder/dp/B09582WLHK/ref=pd\\_di\\_sccai\\_49/141-0917367-9493832?pd\\_rd\\_w=OMt7t&pf\\_rd\\_p=c9443270-b914-4430-a90b-72e3e7e784e0&pf\\_rd\\_r=K5P2V6951V1EJ78KF9ZR&pd\\_rd\\_r=c51df6de-ad8c-44d1-8666-62c7795c0dcc&pd\\_rd\\_wg=vp4hs&pd\\_rd\\_i=B09582WLHK&psc=1](https://www.amazon.com/Umbrella-Stand-Market-Outdoor-Holder/dp/B09582WLHK/ref=pd_di_sccai_49/141-0917367-9493832?pd_rd_w=OMt7t&pf_rd_p=c9443270-b914-4430-a90b-72e3e7e784e0&pf_rd_r=K5P2V6951V1EJ78KF9ZR&pd_rd_r=c51df6de-ad8c-44d1-8666-62c7795c0dcc&pd_rd_wg=vp4hs&pd_rd_i=B09582WLHK&psc=1) (Year: 2021).\*

\* cited by examiner

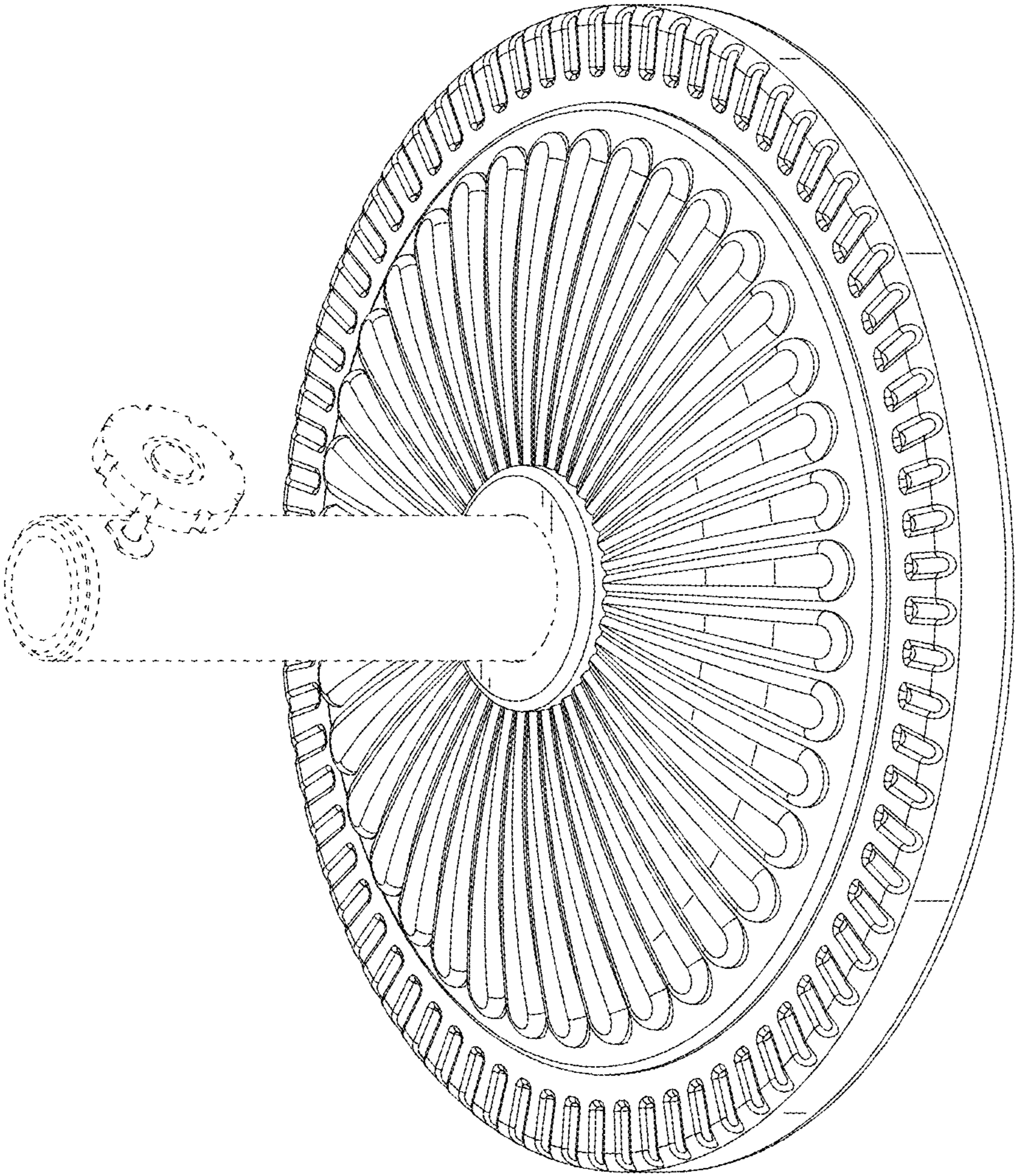

FIG.1

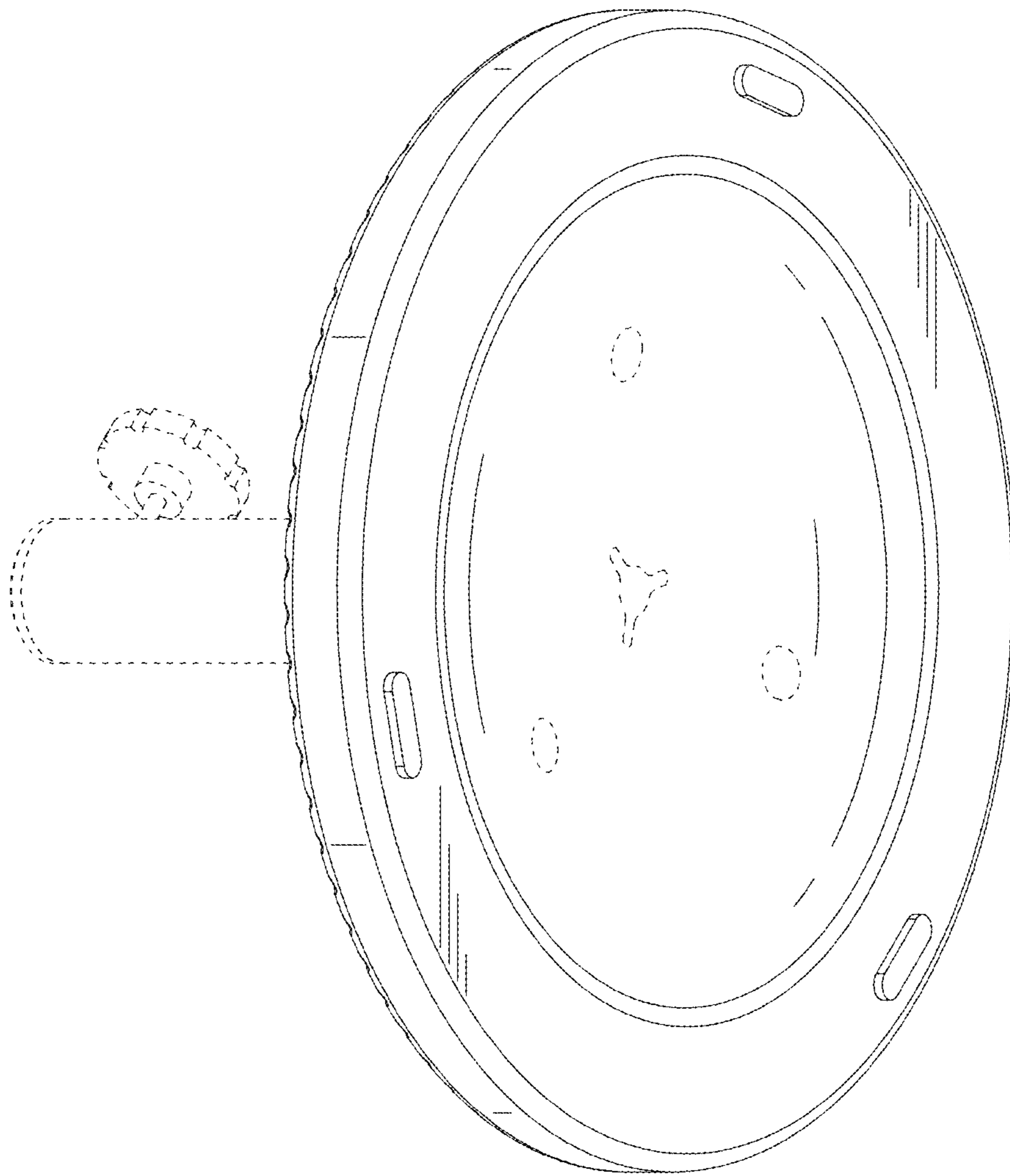

FIG. 2

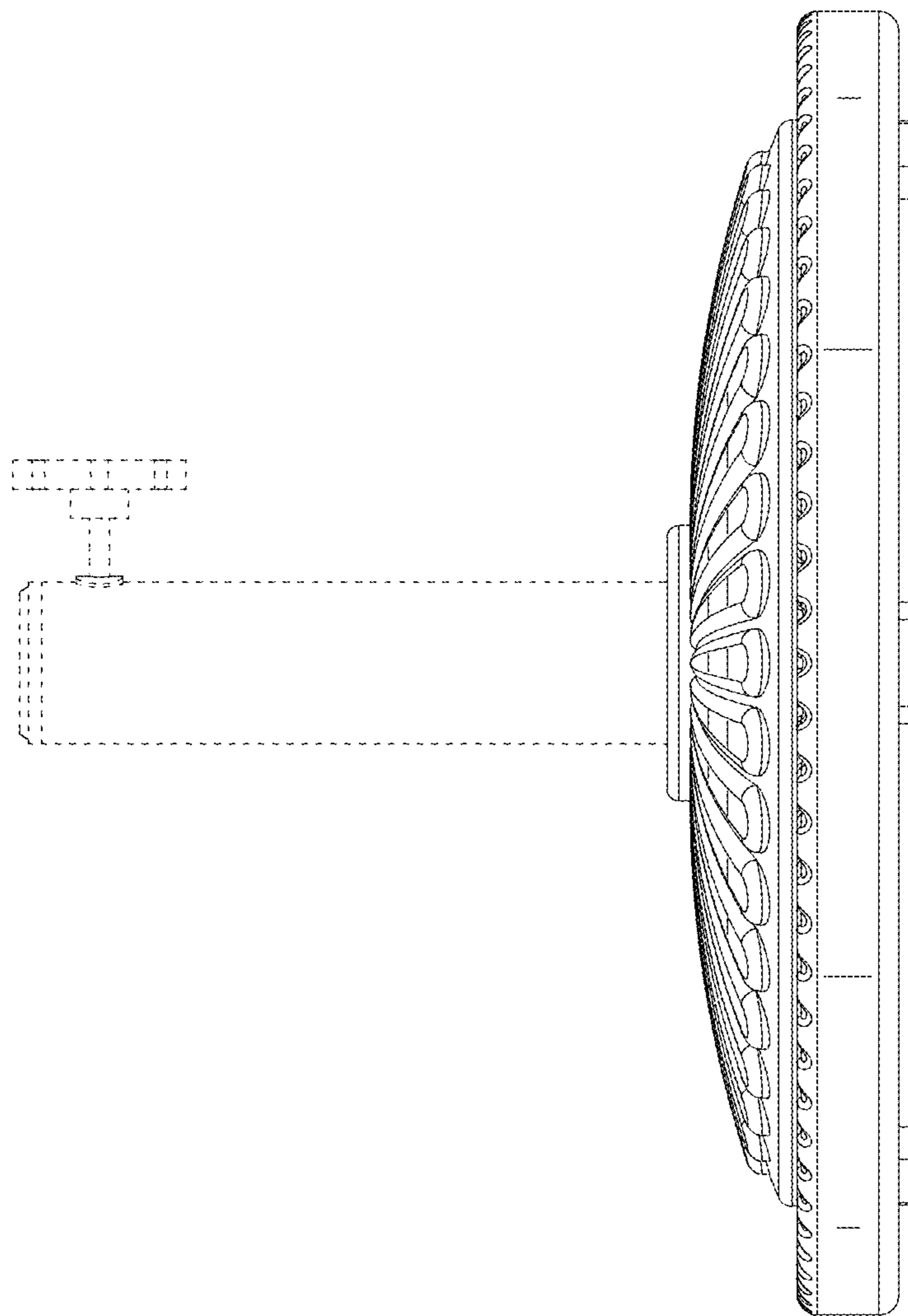

FIG. 3

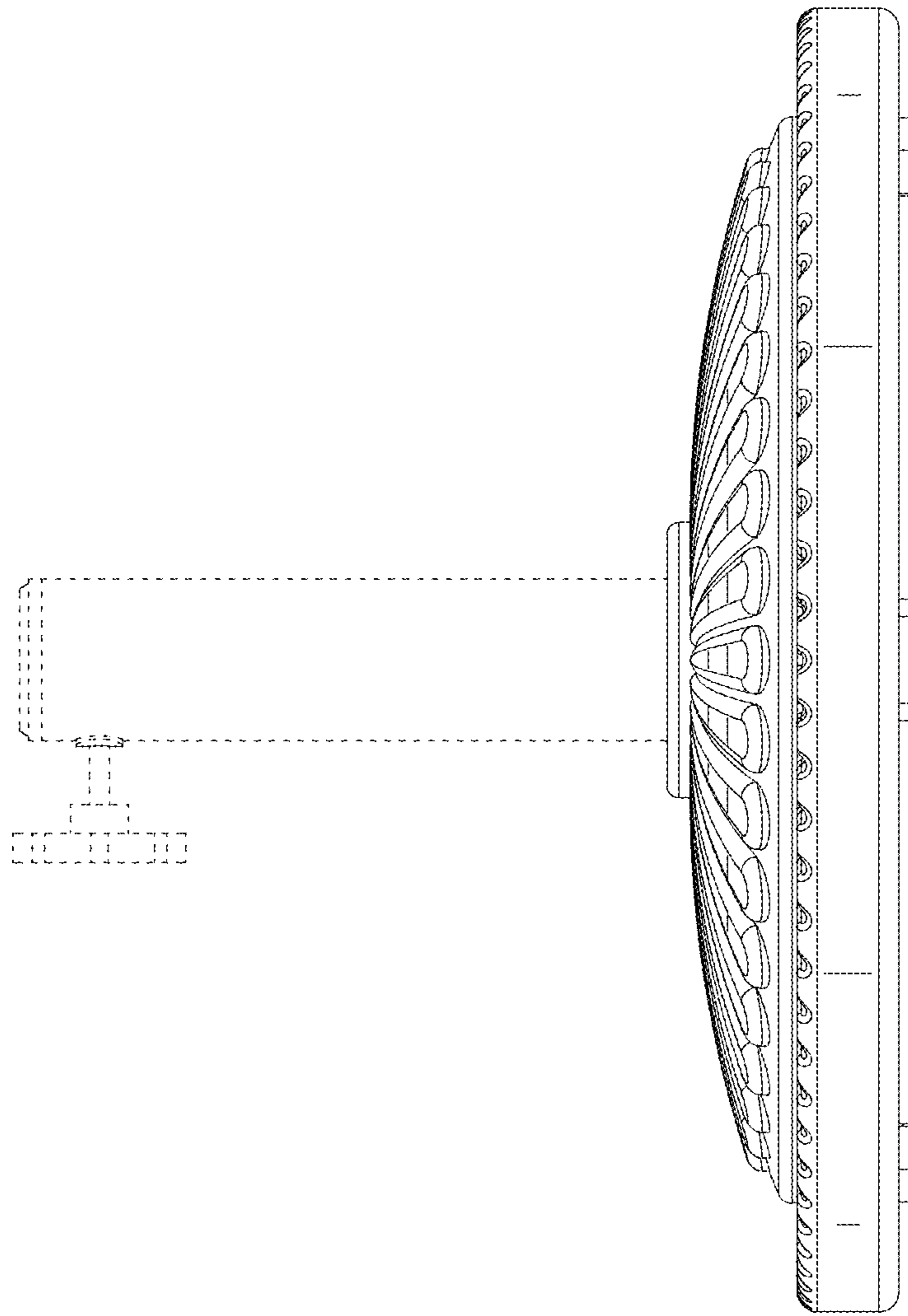

FIG. 4

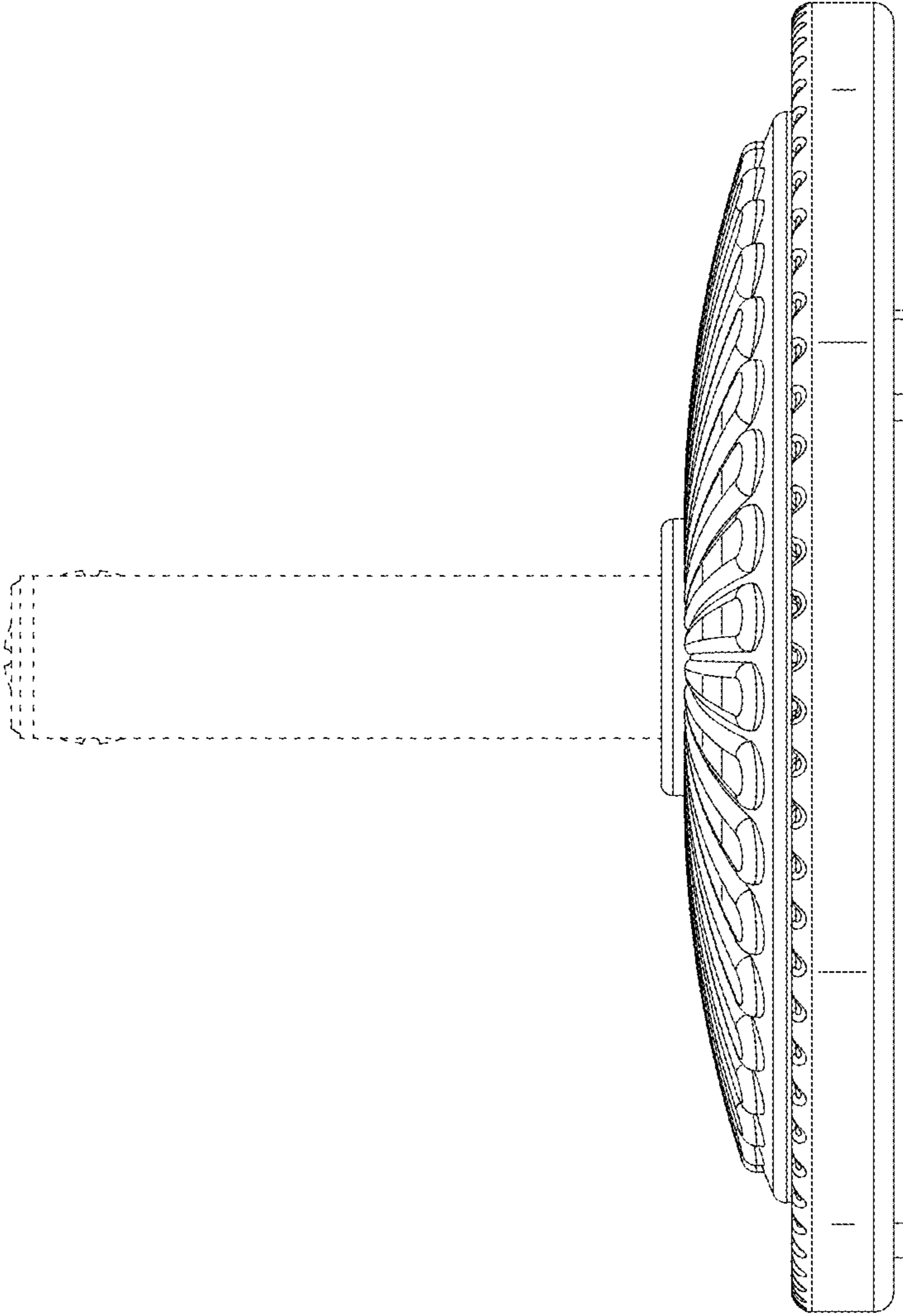

FIG. 5

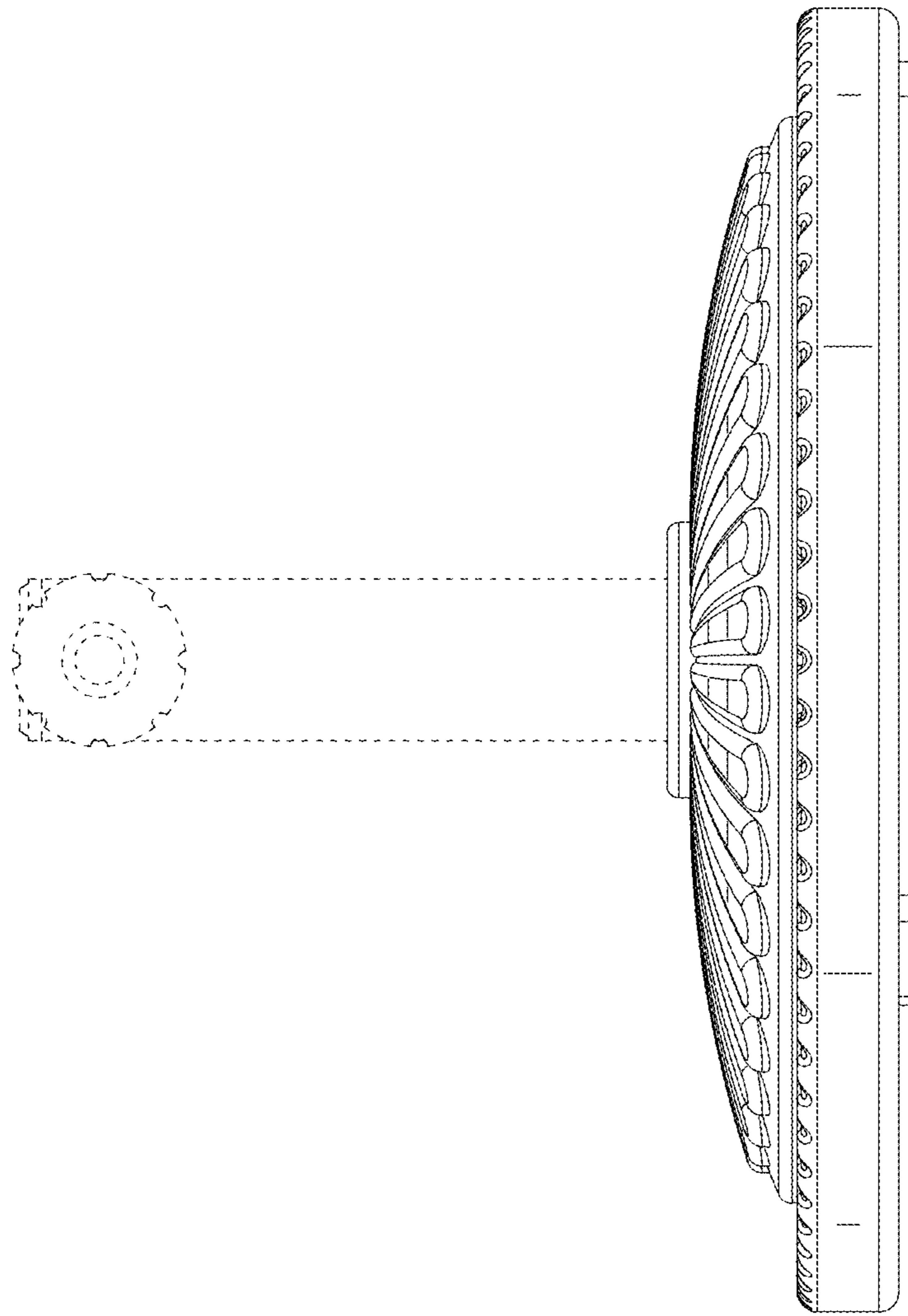

FIG.6



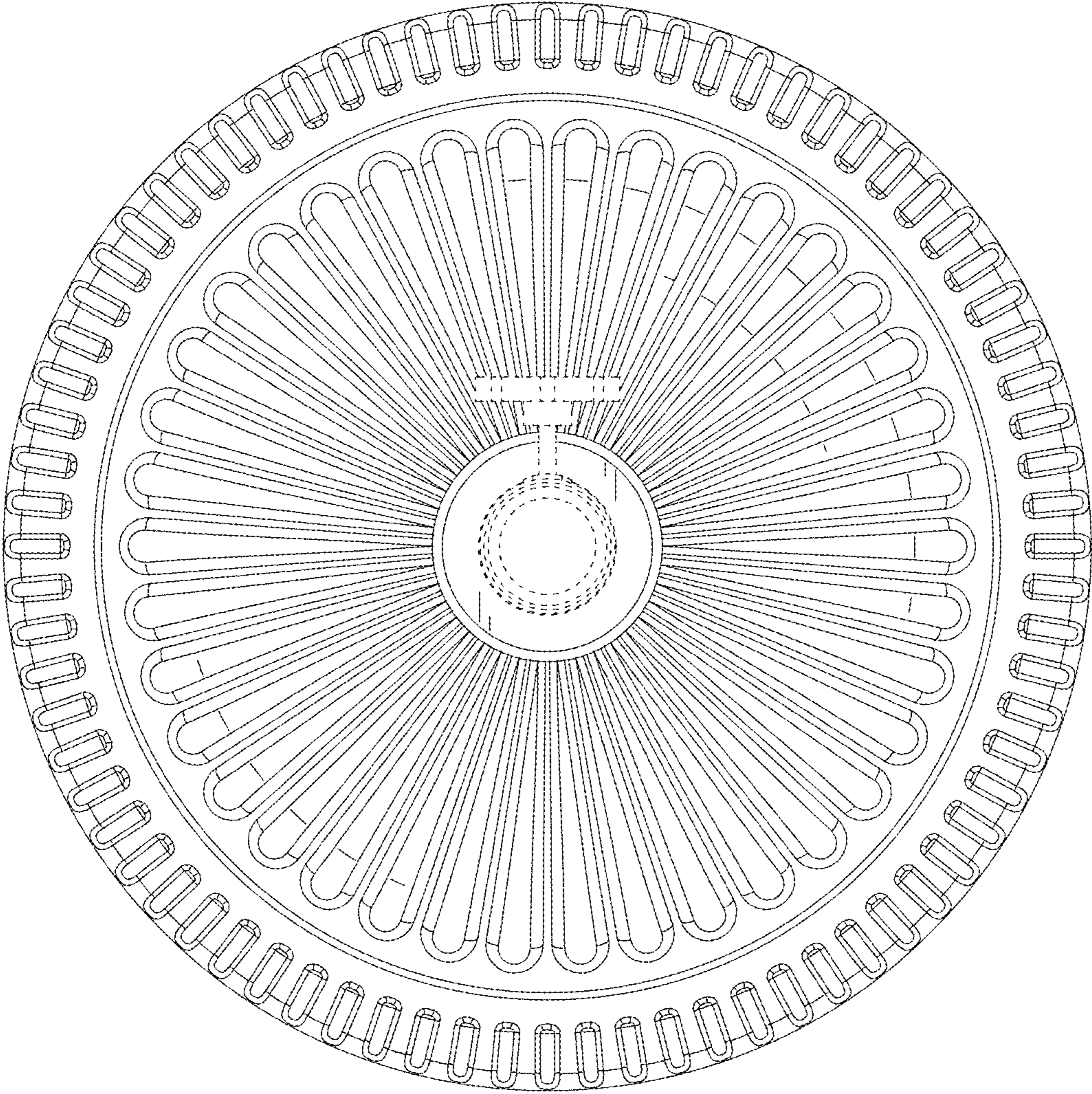

FIG. 7

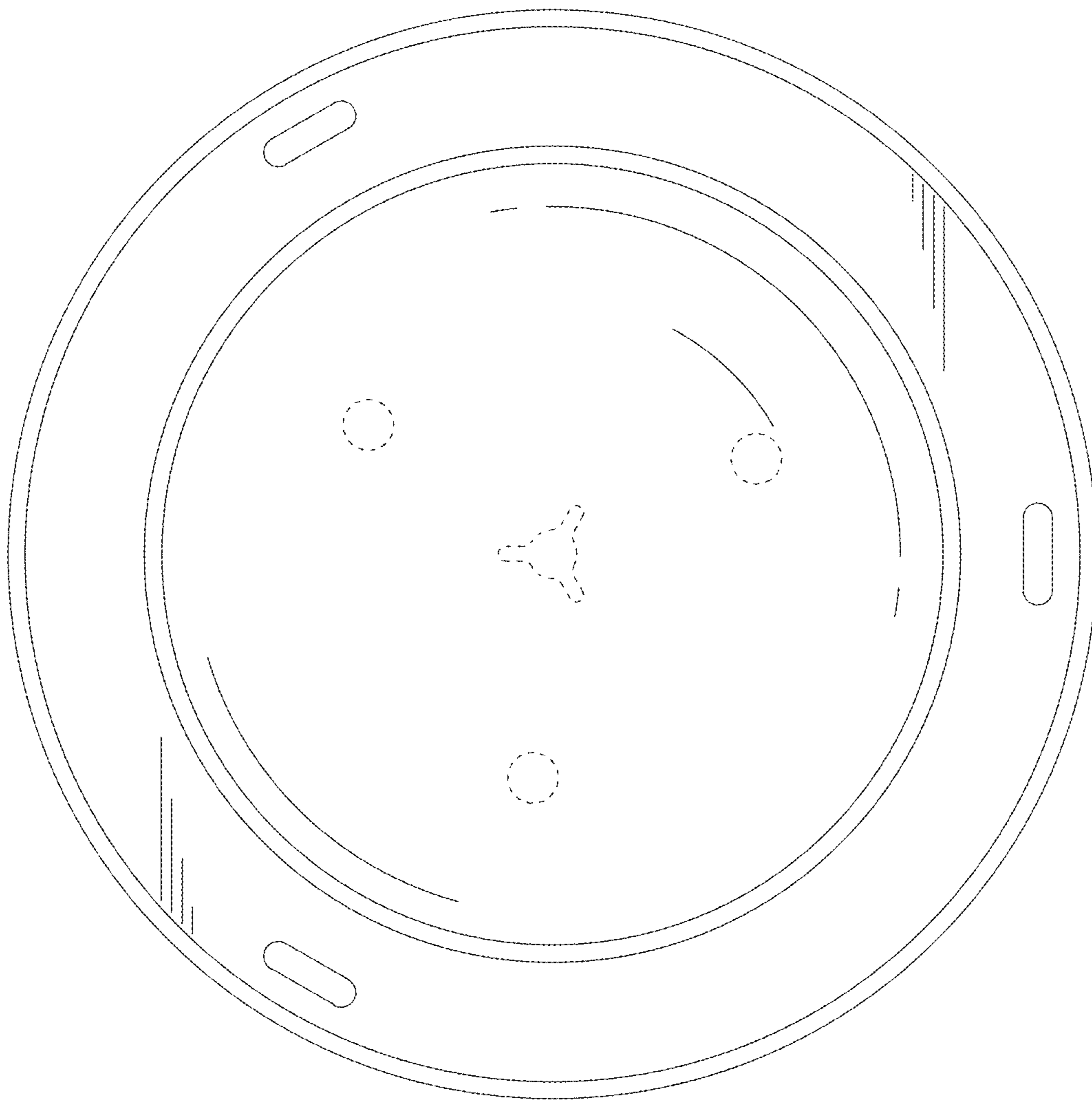

FIG. 8