



US00D932763S

(12) **United States Design Patent** (10) **Patent No.:** **US D932,763 S**
Gibson (45) **Date of Patent:** **** Oct. 12, 2021**

(54) **SHOE**
(71) Applicant: **NIKE, Inc.**, Beaverton, OR (US)
(72) Inventor: **Lee Gibson**, Beaverton, OR (US)
(73) Assignee: **NIKE, Inc.**, Beaverton, OR (US)
(**) Term: **15 Years**

D317,824 S * 7/1991 Hatfield D2/970
D322,505 S 12/1991 Hatfield
D322,712 S * 12/1991 Aveni D2/973
D325,291 S 4/1992 Hatfield
5,276,983 A * 1/1994 Hatfield A43B 23/26
36/1

(Continued)

(21) Appl. No.: **29/714,179**
(22) Filed: **Nov. 21, 2019**
(51) **LOC (13) Cl.** **02-04**
(52) **U.S. Cl.**
USPC **D2/978**; D2/973
(58) **Field of Classification Search**
USPC D2/896, 902-908, 909-912, 928, 929,
D2/943-944, 946-947, 951, 960, 969,
D2/970, 972-975, 976-978; 36/53, 57,
36/3 A; D12/203
CPC B60N 3/044; B60N 3/048; A43C 11/00;
A43C 11/02; A43C 11/04; A43C 11/12;
A43C 11/24; A43C 1/00; A43B 23/00;
A43B 23/0205; A43B 23/021; A43B
23/0215; A43B 23/04; A43B 23/24; A43B
5/06; A43B 5/08; A43B 5/10; A43B 5/14;
A43B 5/00; A43B 5/008; A43B 5/04;
A43B 5/0401; A43B 5/0447; A43B
5/049; A43B 5/1675; A43B 7/08; A43B
7/085; A43B 7/10
See application file for complete search history.

OTHER PUBLICATIONS

Justfreshkicks.Com, "Undeafated x Air Jordan 4", announced Mar. 6, 2018 [online], [site visited Feb. 8, 2021]. Available from internet, URL:https://justfreshkicks.com/undftd-jordan-4-sample-2018/ (Year: 2018).*

(Continued)

Primary Examiner — Marissa J Cash
Assistant Examiner — Yelizaveta Y Masalimova
(74) *Attorney, Agent, or Firm* — Banner & Witcoff, Ltd.

(57) **CLAIM**

The ornamental design for a shoe, as shown and described.

DESCRIPTION

FIG. 1 is a front perspective view of a shoe showing my new design;
FIG. 2 is a side view thereof;
FIG. 3 is an opposite side view thereof;
FIG. 4 is a rear perspective view thereof;
FIG. 5 is an opposite side front perspective view thereof;
and,
FIG. 6 is an enlarged view of Region 6 identified in FIG. 2. The racetrack shaped areas formed by broken lines and the unshaded areas therein represent eyelets that form no part of the claimed design. The broken lines depicting the remainder of the shoe form no part of the claimed design. The evenly spaced broken lines in FIGS. 2 and 6 illustrating the enlarged view are for annotation purposes only and form no part of the claimed design.

(56) **References Cited**
U.S. PATENT DOCUMENTS

D301,657 S * 6/1989 Brown D2/972
D307,210 S 4/1990 Hatfield
D310,290 S * 9/1990 Ringel D2/969
D311,092 S 10/1990 Hatfield
D316,323 S * 4/1991 Hatfield D2/972

1 Claim, 6 Drawing Sheets

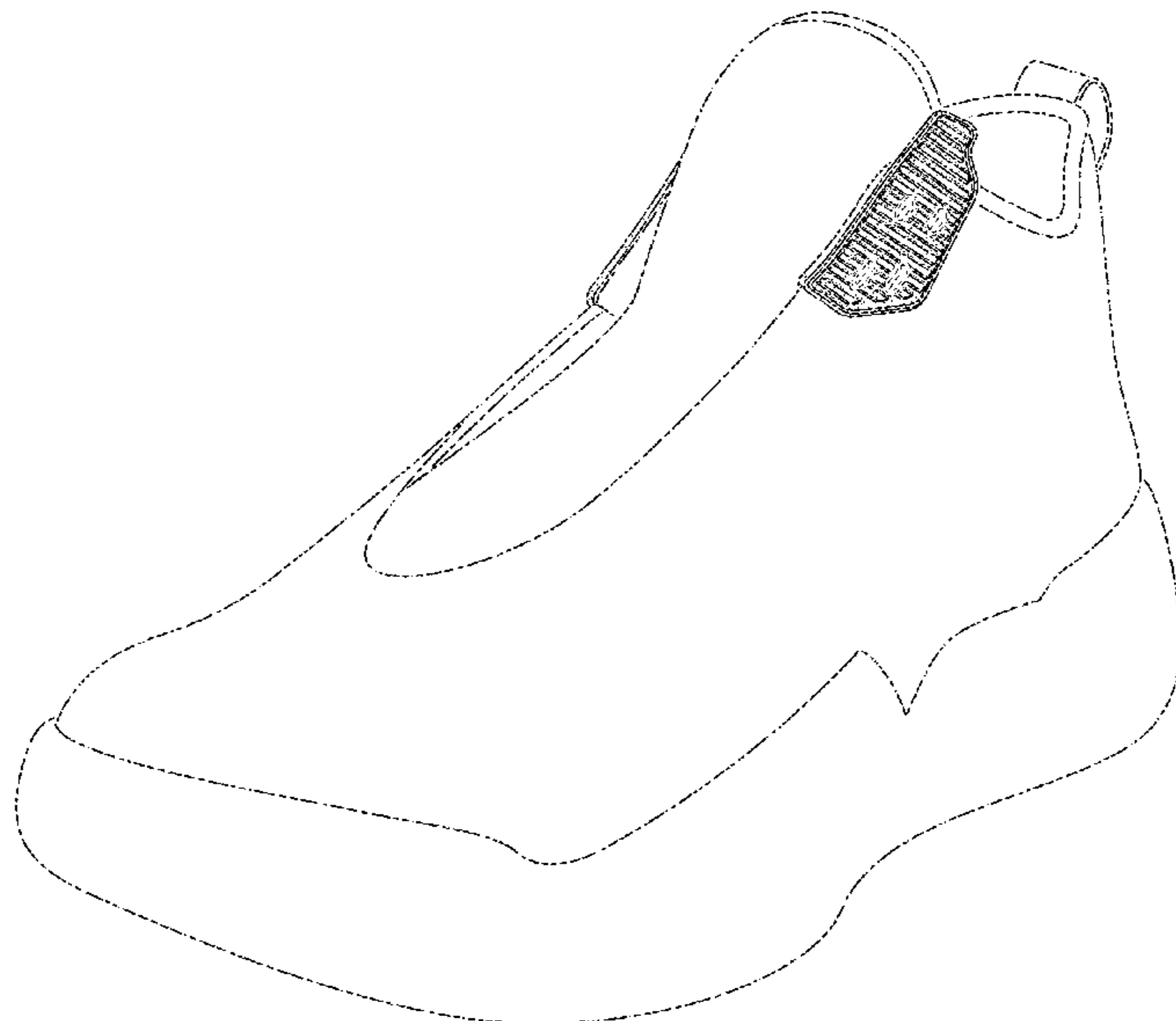

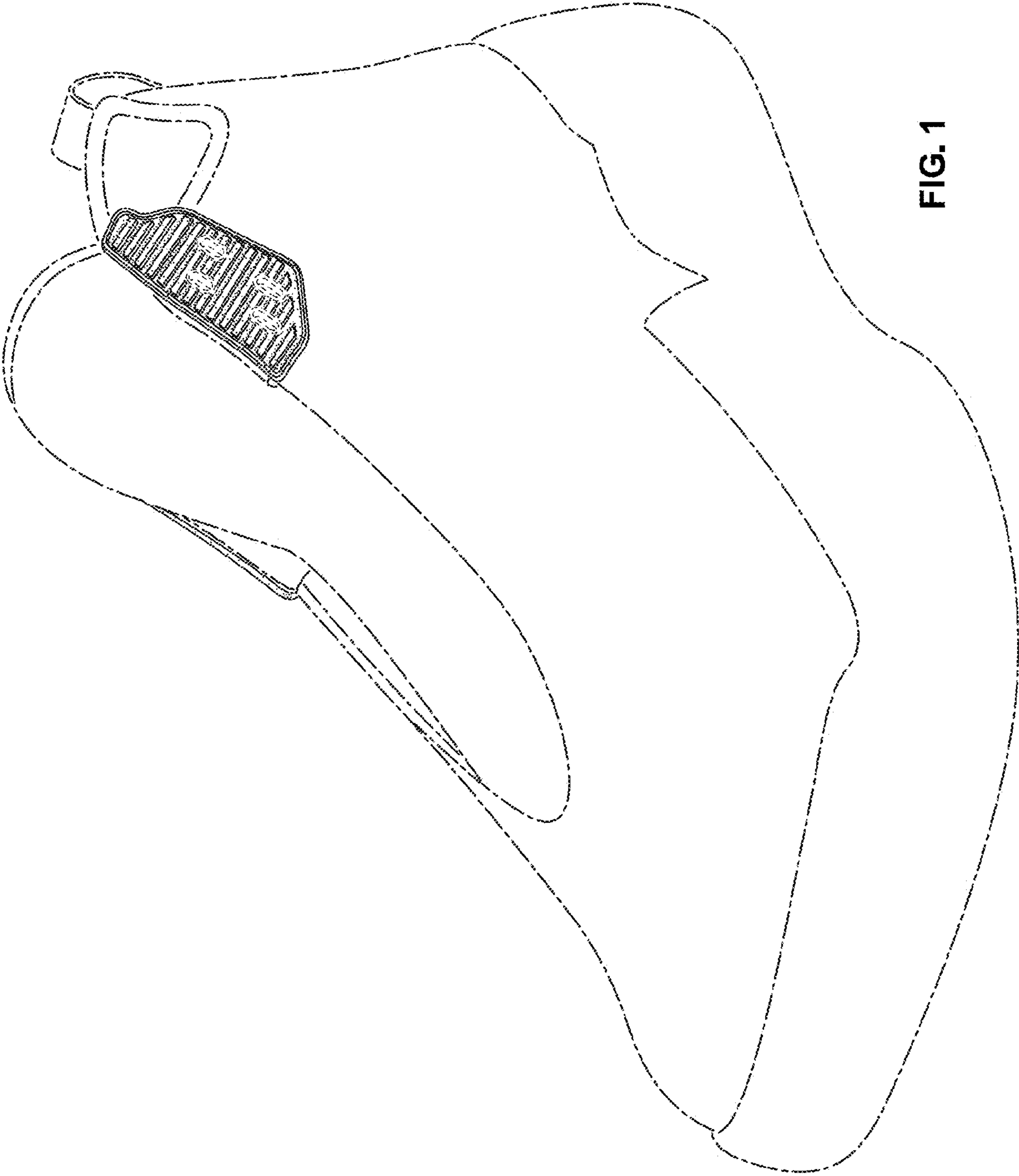

FIG. 1

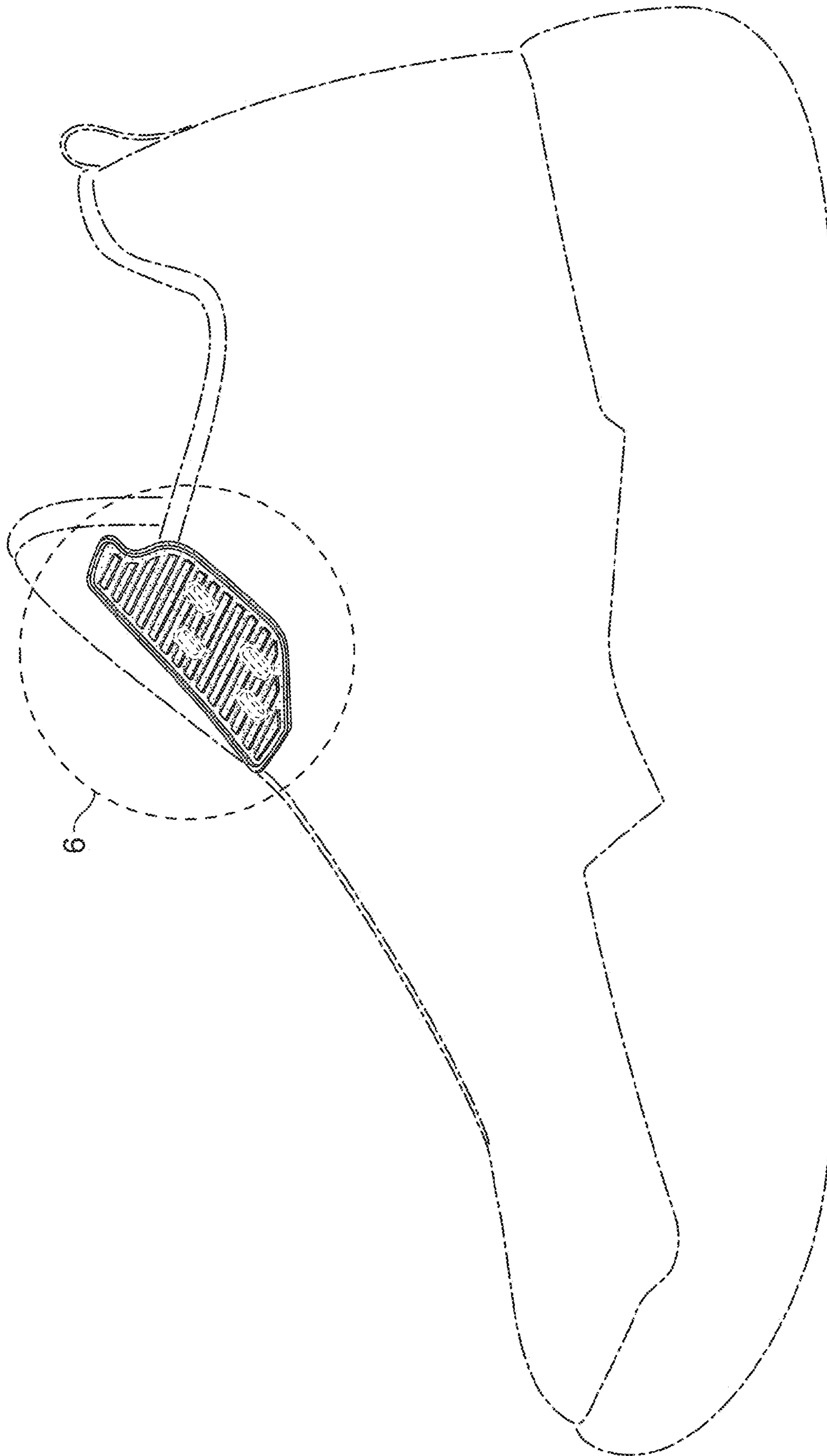

FIG. 2

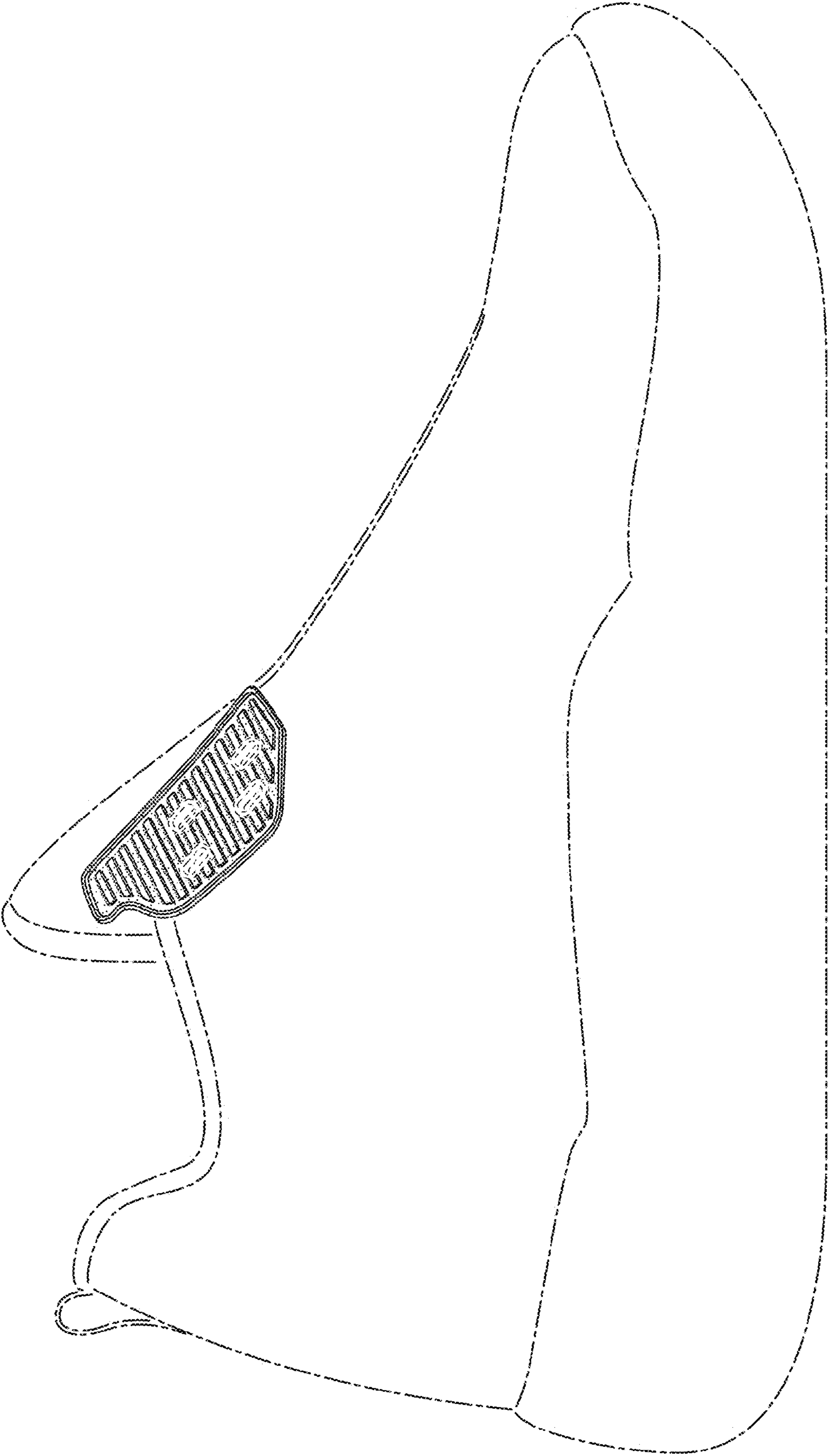

FIG. 3

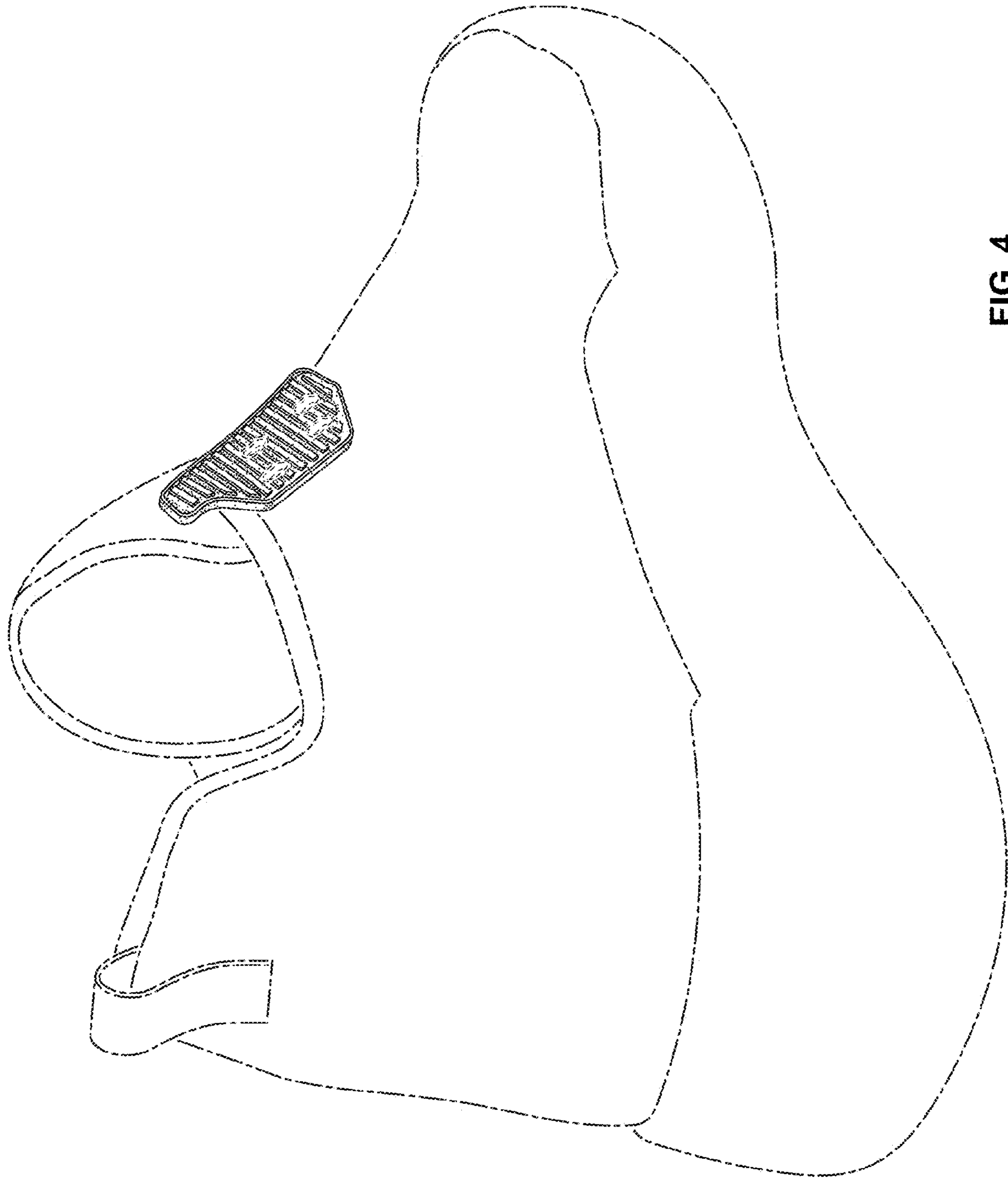

FIG. 4

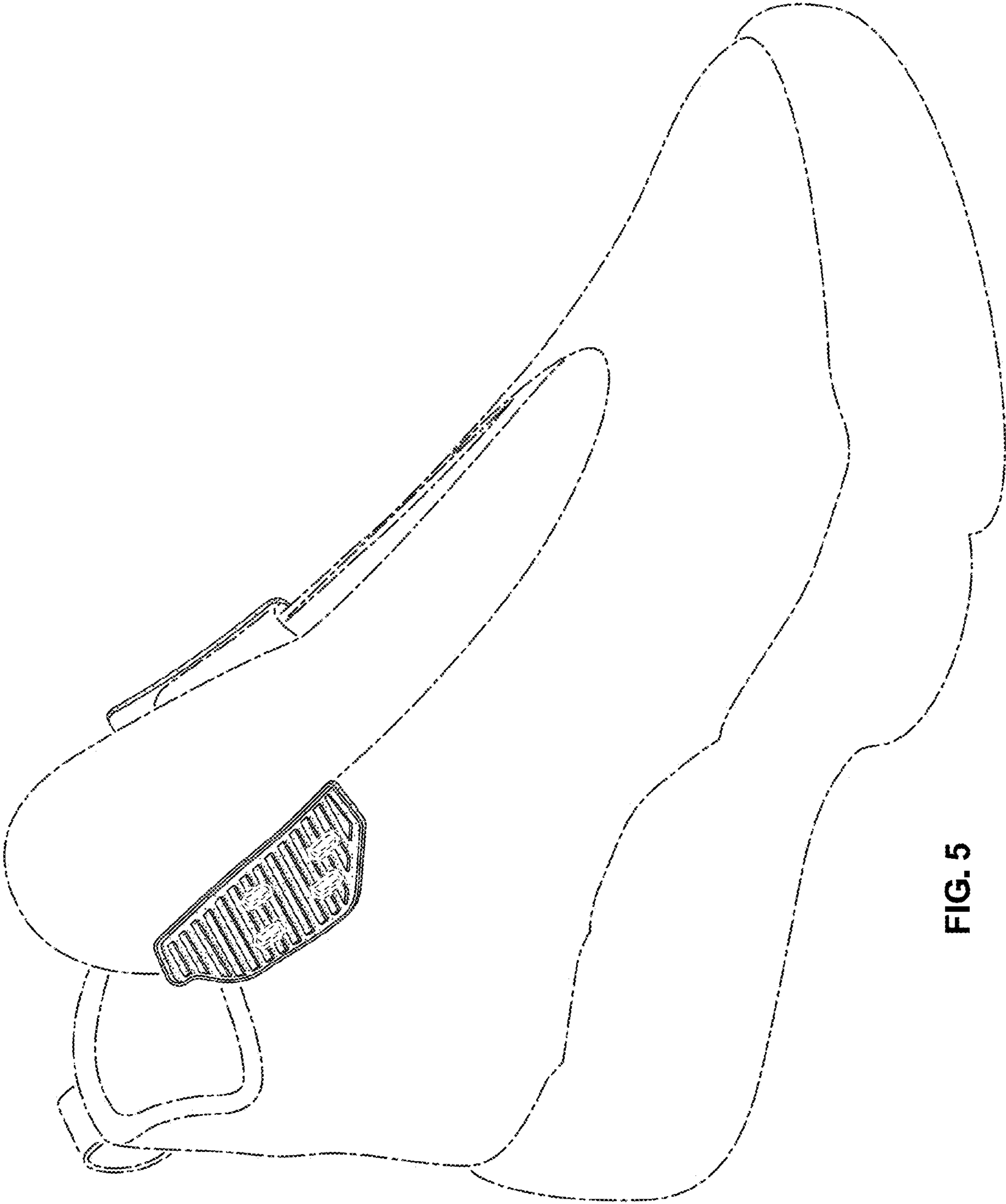

FIG. 5

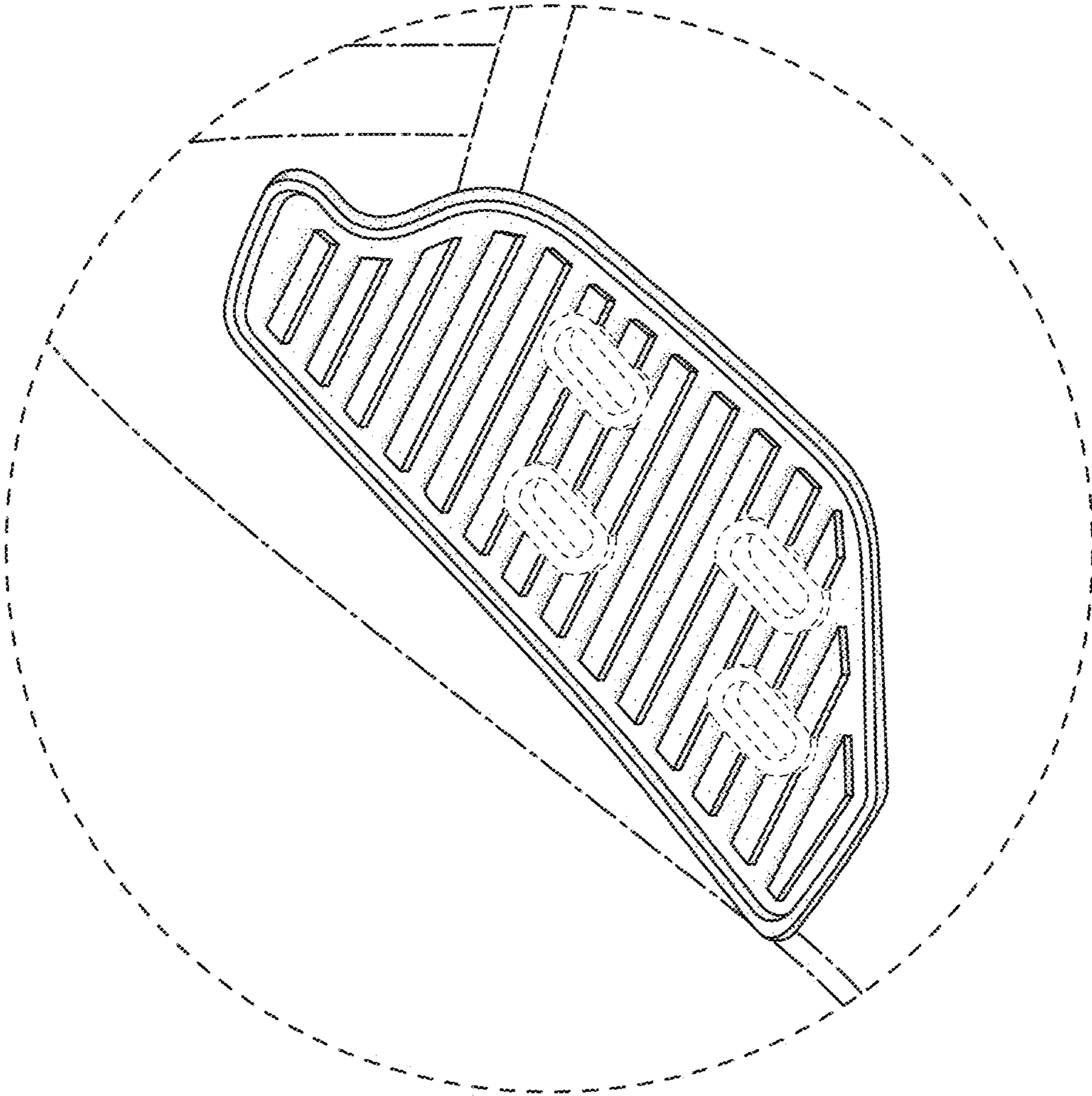

FIG. 6