



US00D932710S

(12) **United States Design Patent**
Jenni

(10) **Patent No.:** **US D932,710 S**

(45) **Date of Patent:** **** Oct. 5, 2021**

(54) **GYMNASTICS HAND GRIP**

(71) Applicant: **Jenang Pty Ltd**, New Town (AU)

(72) Inventor: **Angela Jenni**, New Town (AU)

(73) Assignee: **Jenong Pty. Ltd.**, New Town (AU)

(**) Term: **15 Years**

(21) Appl. No.: **29/722,243**

(22) Filed: **Jan. 28, 2020**

(51) **LOC (13) Cl.** **02-06**

(52) **U.S. Cl.**

USPC **D29/113**

(58) **Field of Classification Search**

USPC D29/113, 114, 116.2, 117.1, 117.2, 120.1

CPC A41D 19/015; A41D 2600/20; A41D

2600/10; A41D 19/0044; A41D 19/00;

A41D 19/0055; A41D 19/0003; A41D

13/087; A41D 31/04; A41D 31/10; A63B

71/143; A63B 71/146; A63B 21/4019

See application file for complete search history.

(56) **References Cited**

U.S. PATENT DOCUMENTS

D267,129 S * 12/1982 Kneisley D29/113

D285,821 S * 9/1986 Kneisley D11/5

5,298,001 A * 3/1994 Goodson A63B 21/4021

2/161.1

D459,772 S * 7/2002 Meldeau D21/662

D741,974 S * 10/2015 Lung D21/797

D751,771 S * 3/2016 Hunter D29/117.1

D806,956 S * 1/2018 Hunter D29/117.1

D824,112 S * 7/2018 Picon D29/117.2

D863,464 S * 10/2019 Rhodes D21/662

D868,387 S * 11/2019 Picon D29/117.2

D869,094 S * 12/2019 Picon D29/117.2

D869,095 S * 12/2019 Picon D29/117.2

2003/0199364 A1* 10/2003 Mah A63B 21/4021

482/23

2005/0081273 A1* 4/2005 Ota A63B 71/14

2/17

2017/0348584 A1* 12/2017 Rhodes A41D 13/0568

OTHER PUBLICATIONS

Reisport Ladies Hook and Loop Uneven Bar Grips, posted at amazon.com, posting date by Dec. 10, 2015, [online], [site visited May 7, 2021]. Available from Internet, URL: <https://www.amazon.com/Reisport-Ladies-Hook-Uneven-Grips/dp/B06Y2FFPY2/> (Year: 2015).*

CrazyFox Gymnastics Hand Grips, posted at amazon.com, posting date Jan. 19, 2019, [online], [site visited May 7, 2021]. Available from Internet, URL: <https://www.amazon.com/Gymnastics-Protection-Training-Kettlebells-Powerlifting/dp/B07MY7H4JM?th=1&psc=1> (Year: 2019).*

(Continued)

Primary Examiner — George D. Kirschbaum

Assistant Examiner — Maria J. Edwards

(74) *Attorney, Agent, or Firm* — Eric Karich; Karich & Associates

(57)

CLAIM

The ornamental design for a gymnastics hand grip, as shown and described.

DESCRIPTION

FIG. 1 is a perspective view of a gymnastics hand grip, showing my new design;

FIG. 2 is a front elevational view thereof;

FIG. 3 is a rear elevational view thereof;

FIG. 4 is a left side elevational view thereof;

FIG. 5 is a right side elevational view thereof;

FIG. 6 is a top plan view thereof; and,

FIG. 7 is a bottom plan view thereof.

1 Claim, 5 Drawing Sheets

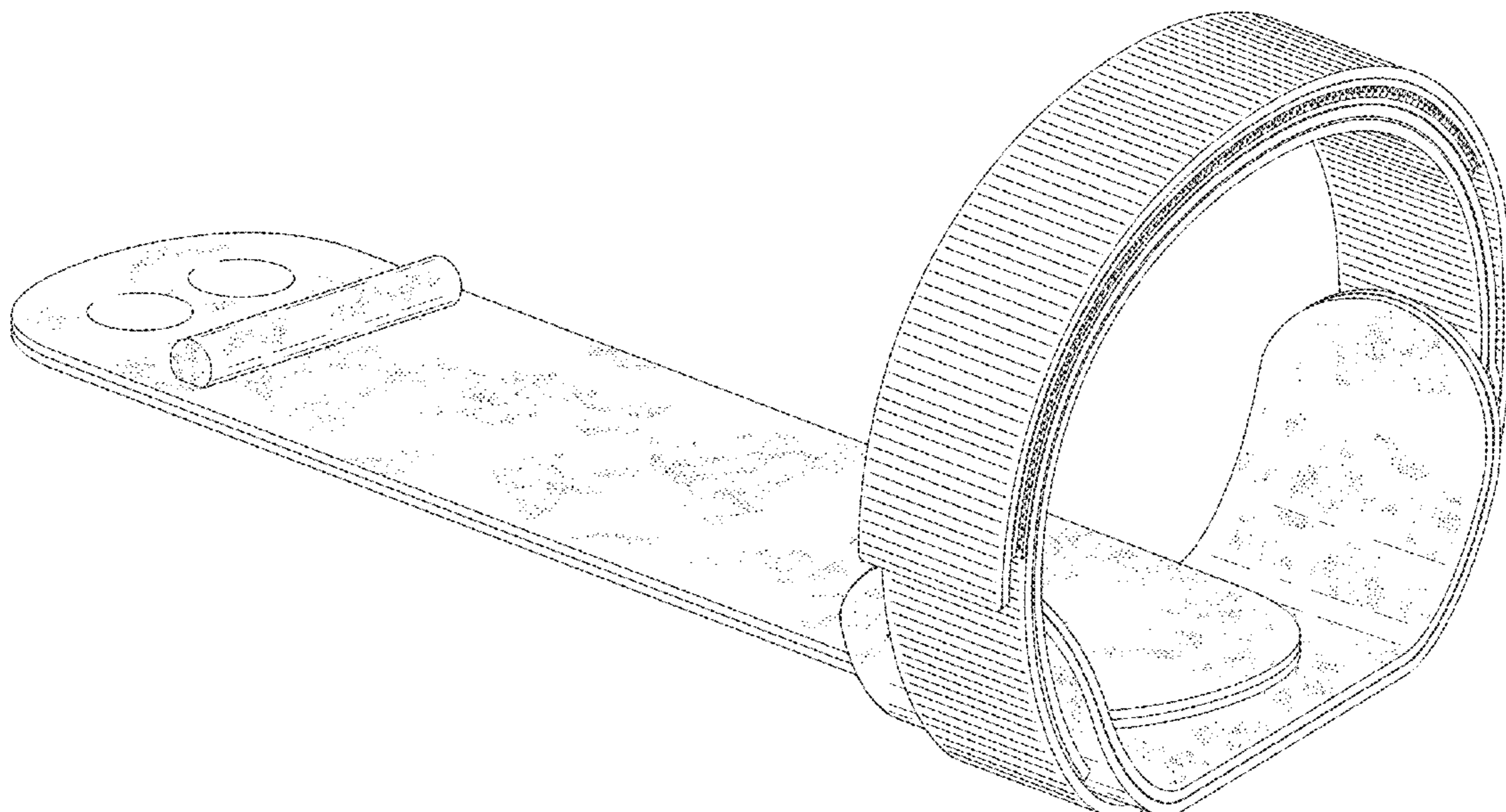

(56)

References Cited

OTHER PUBLICATIONS

US Glove Women Regular Uneven Bar Grips, posted at amazon.com, posting date Oct. 5, 2020, [online], [site visited May 7, 2021]. Available from Internet, URL: <https://www.amazon.com/US-Glove-Regular-Uneven-Gymnastics/dp/B08KPLMJ1Z/?th=1> (Year: 2020).*

Leviero Gymnastics Grips, posted at amazon.com, posting date by Dec. 18, 2019, [online], [site visited May 7, 2021]. Available from Internet, URL: <https://www.amazon.com/dp/B07YFT34GD/> (Year: 2019).*

* cited by examiner

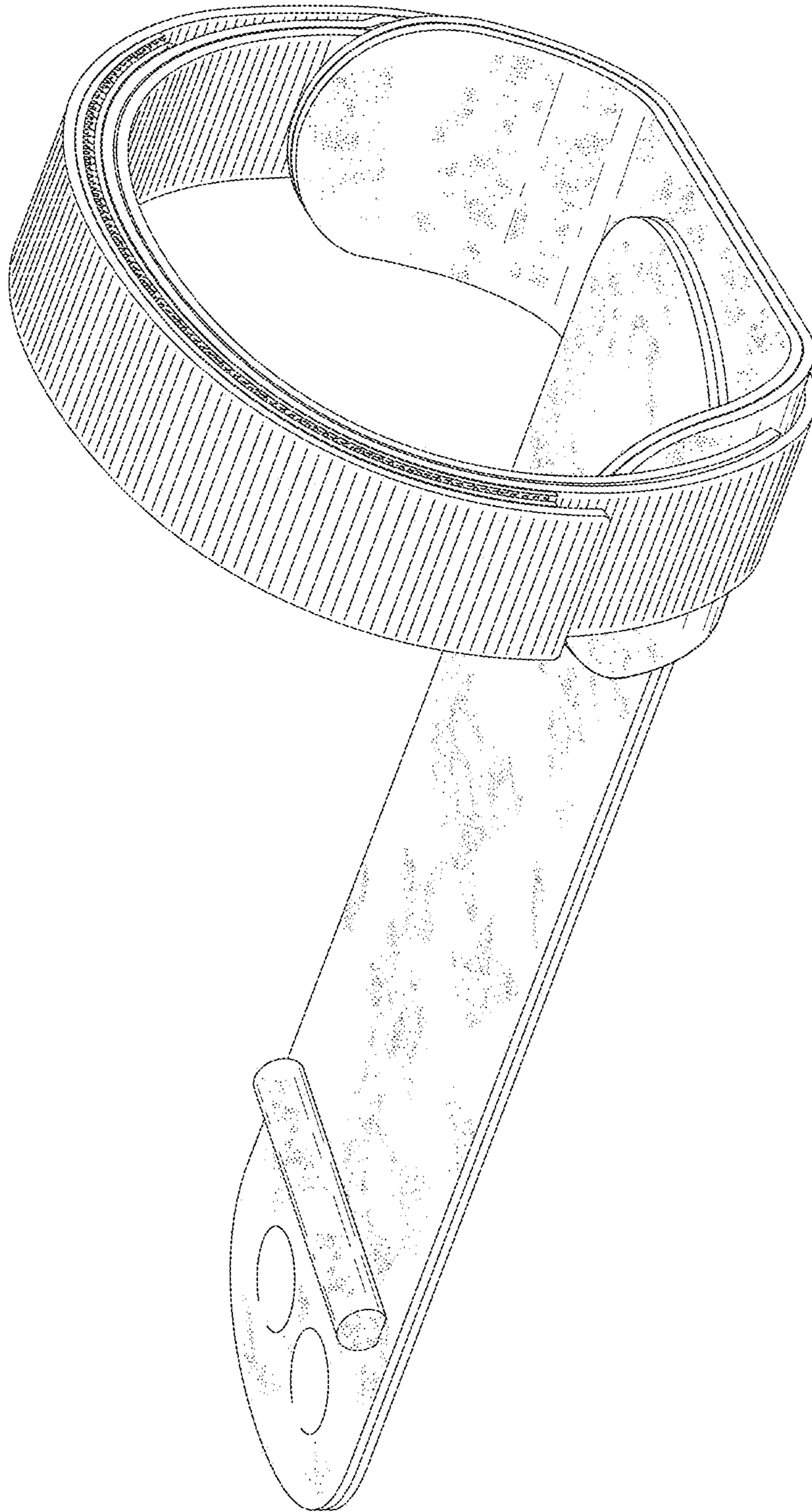

Fig. 1

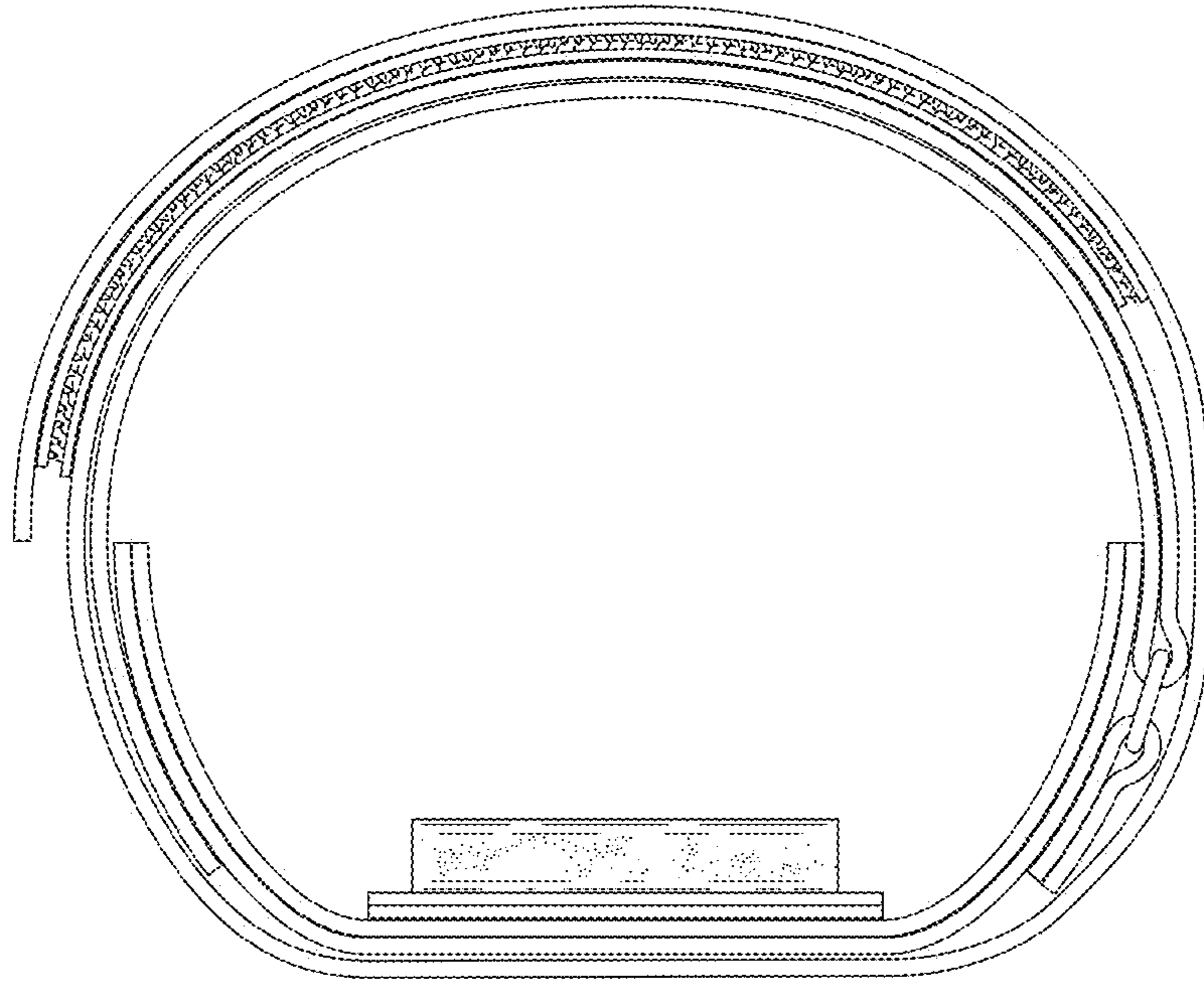

Fig. 2

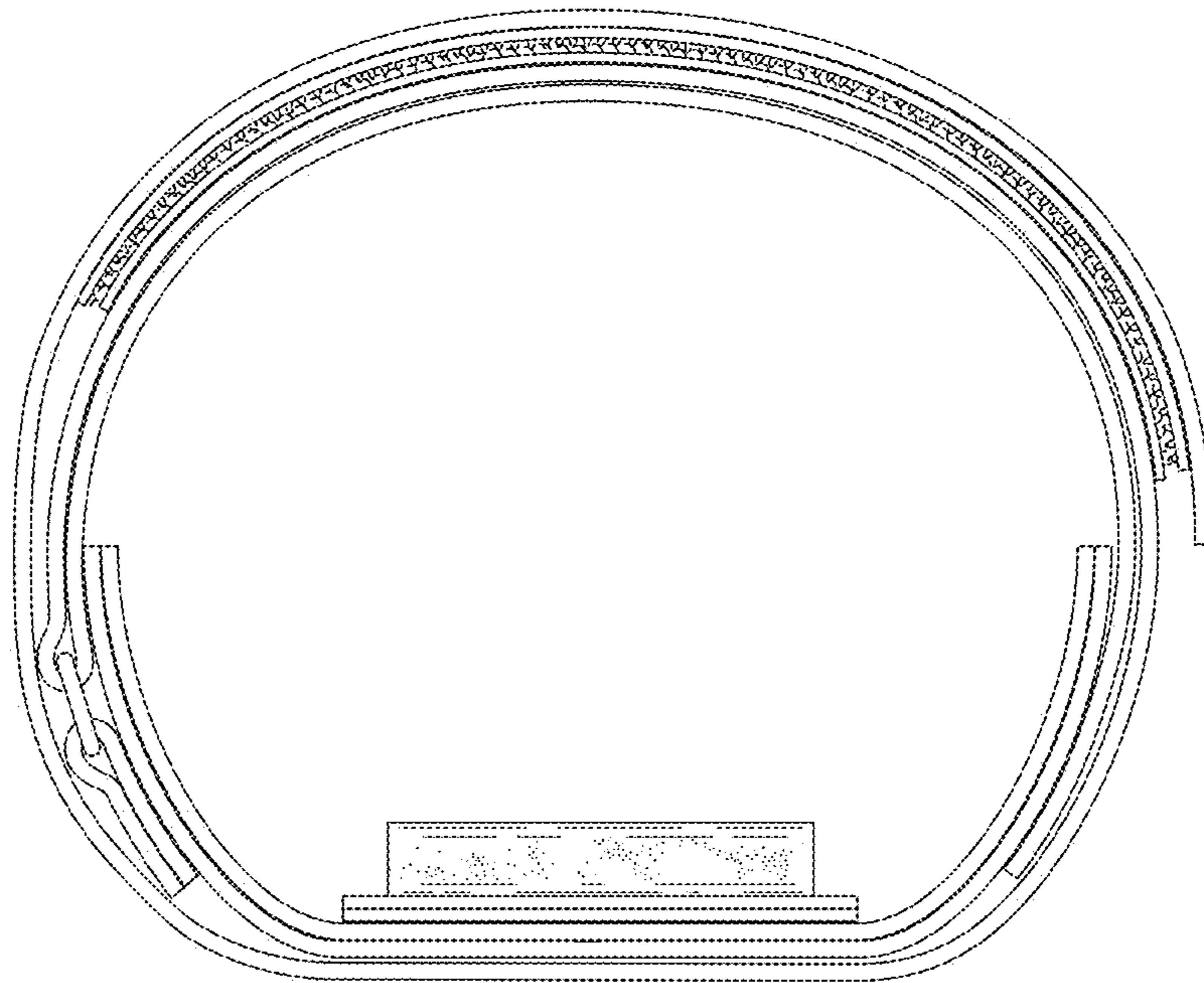

Fig. 3

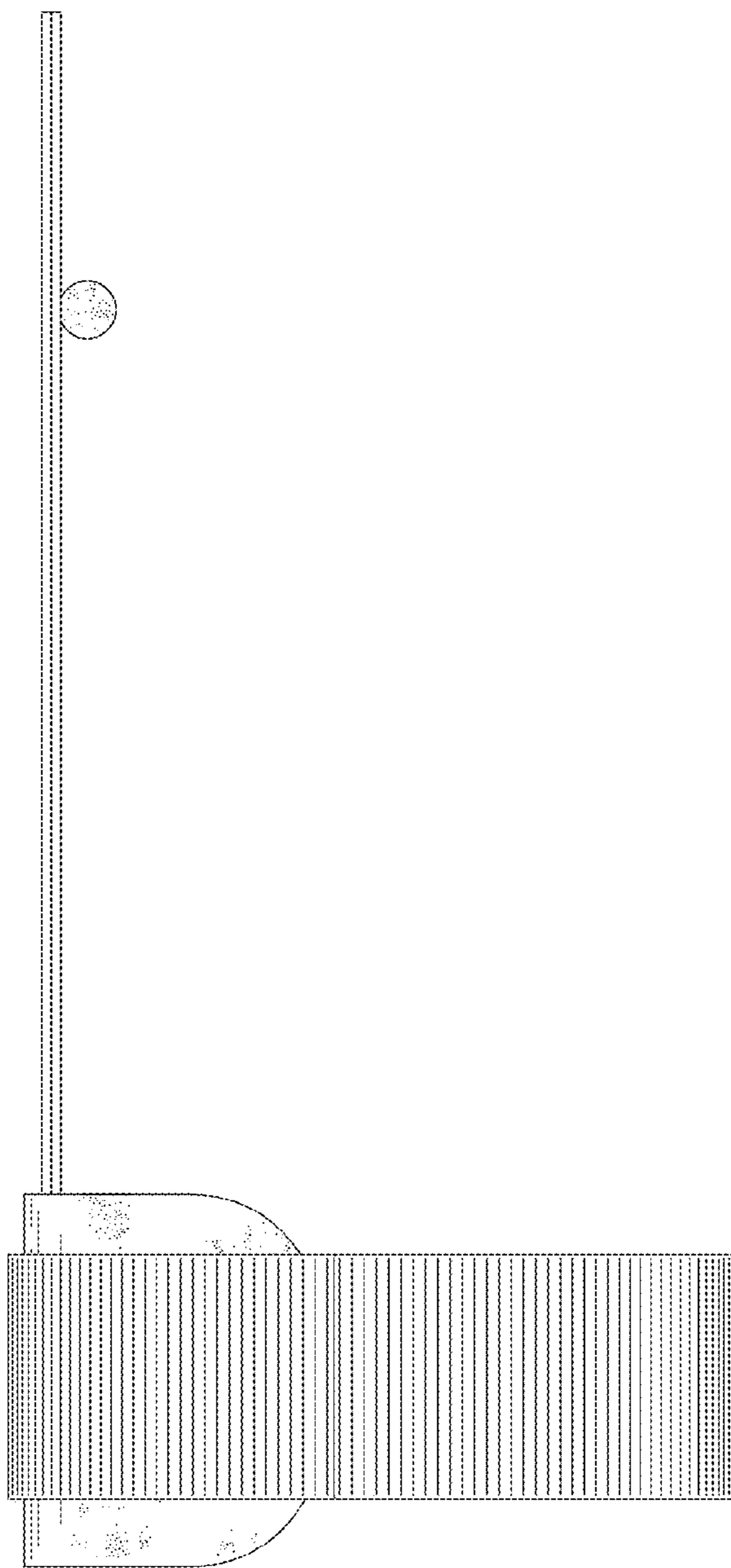

Fig. 4

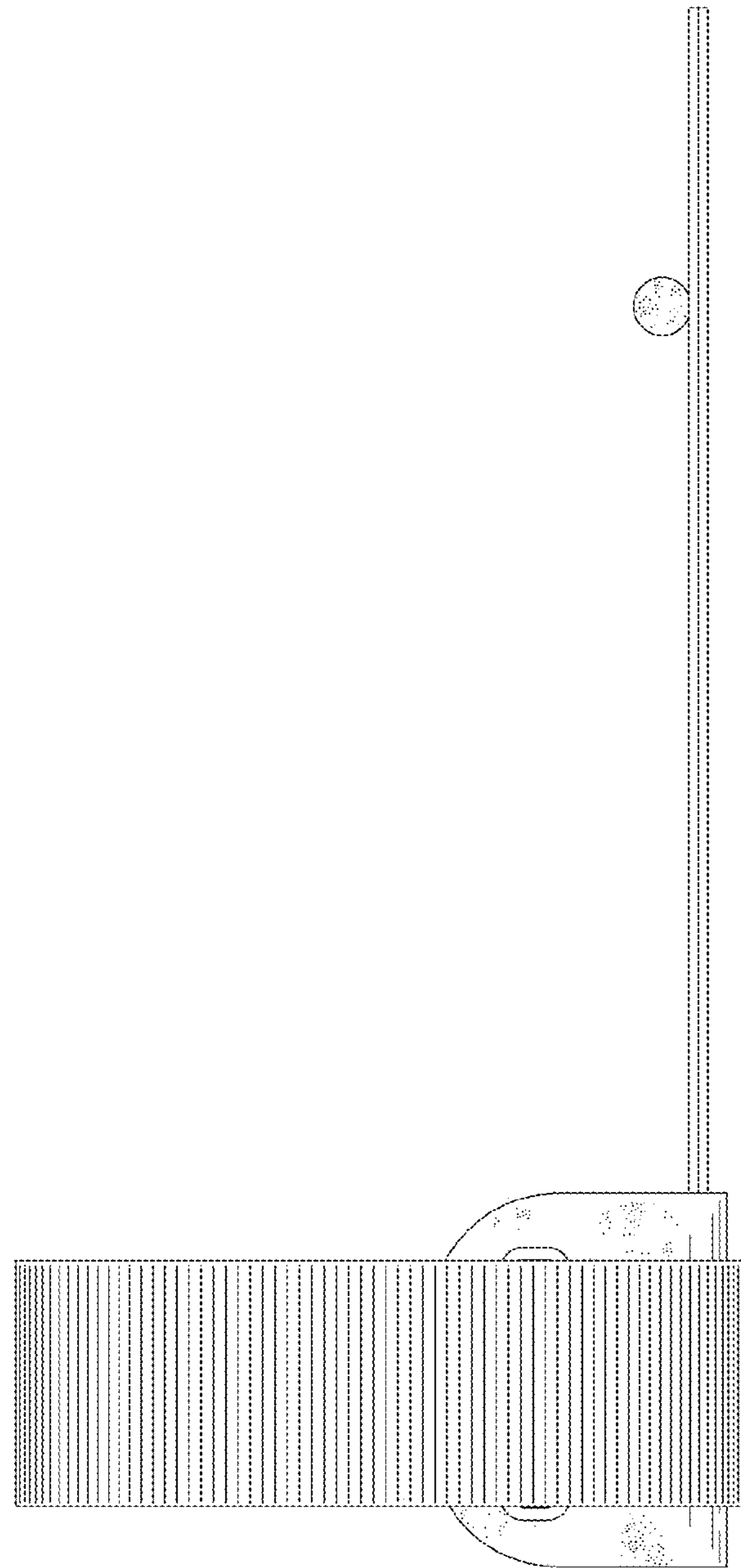

Fig. 5

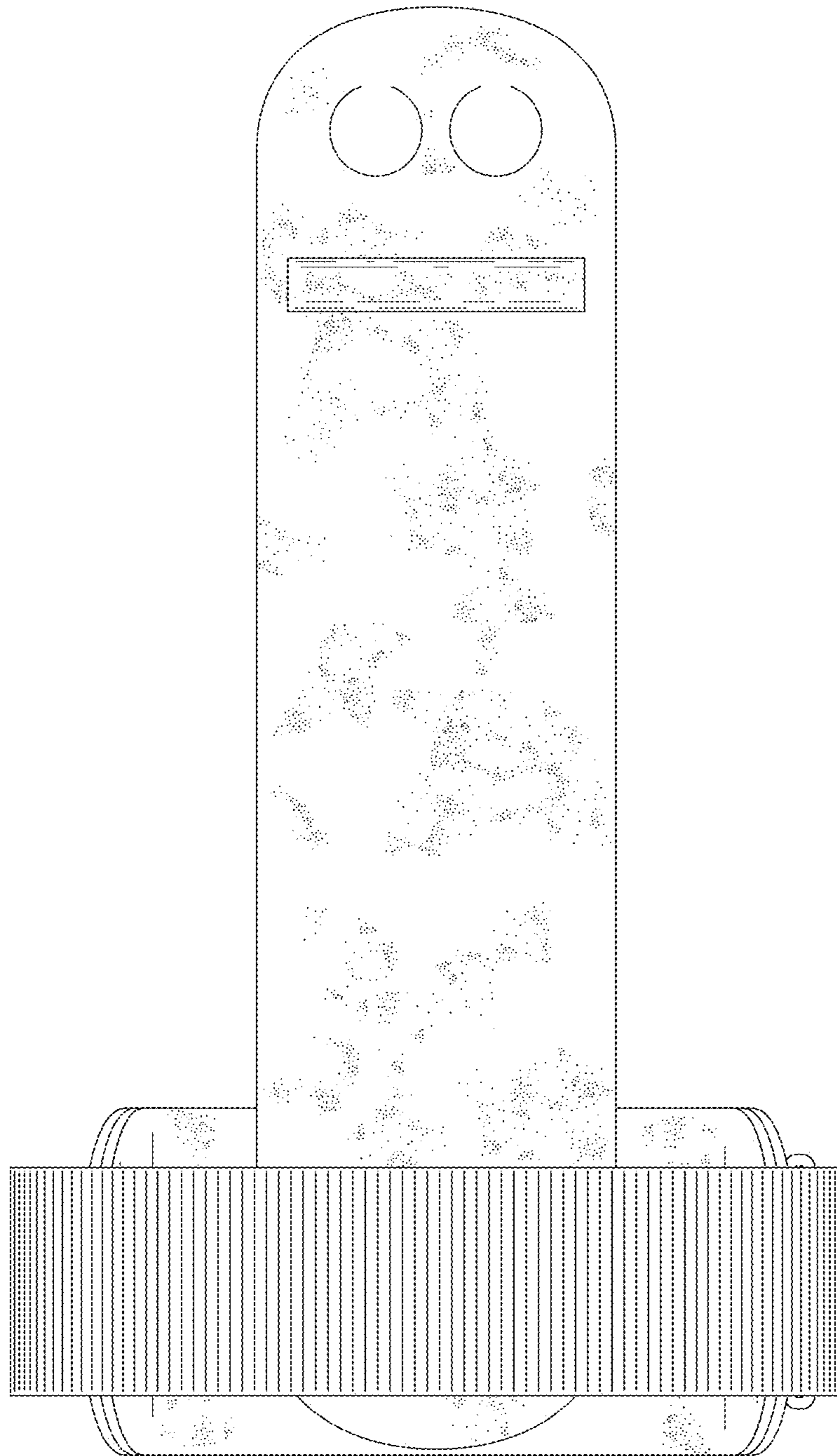

Fig. 6

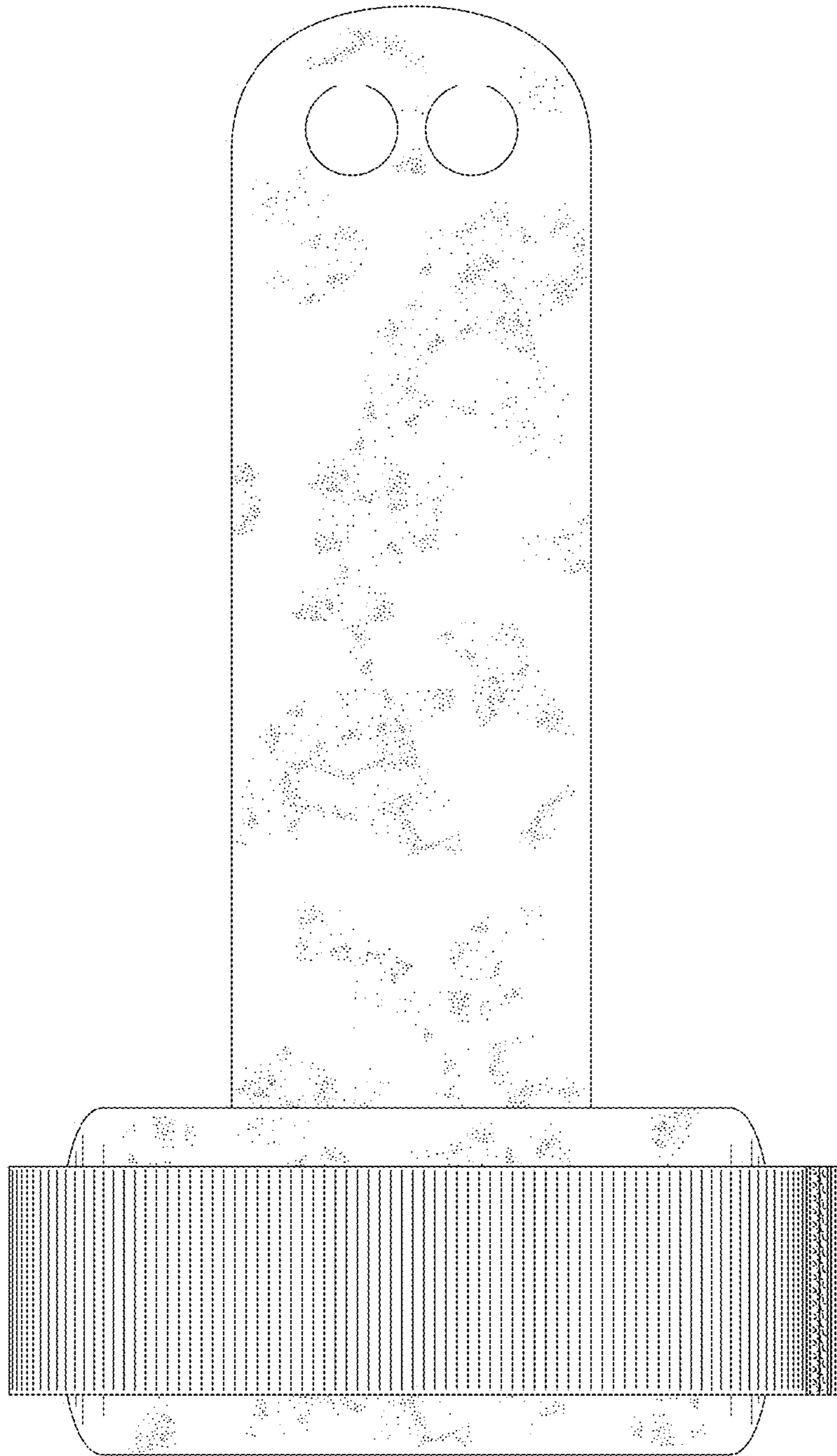

Fig. 7