



US00D932672S

(12) **United States Design Patent** (10) **Patent No.:** **US D932,672 S**
Noga (45) **Date of Patent:** **** Oct. 5, 2021**

(54) **FISHING LIGHT**

6,671,995 B1 1/2004 Harkin
D490,179 S * 5/2004 Niemann D26/37
6,830,360 B1 * 12/2004 Galvez F21L 14/023
362/235

(71) Applicant: **Rebecca Noga**, Edgewater, FL (US)

(72) Inventor: **Rebecca Noga**, Edgewater, FL (US)

(Continued)

(**) Term: **15 Years**

FOREIGN PATENT DOCUMENTS

(21) Appl. No.: **29/695,961**

CN 207635150 U * 12/2017 F21S 8/00

(22) Filed: **Jun. 24, 2019**

OTHER PUBLICATIONS

(51) **LOC (13) Cl.** **26-02**

(52) **U.S. Cl.**

USPC **D26/42**; D26/37

(58) **Field of Classification Search**

USPC D26/37-44, 46-52

CPC .. F21Y 2107/30; F21Y 2107/40; F21V 21/06;

F21V 21/32; F21V 21/145; F21V 21/30;

F21V 21/40; F21V 21/0965; F21V

15/015; F21V 5/007; F21V 5/10; F21K

9/272; F21K 9/275; F21K 9/60; F21K

9/65; F21S 4/20

See application file for complete search history.

“IllumiSea Brightest Fishing Light,” Dec. 19, 2017, amazon.com, site visited Aug. 12, 2021, URL: <https://www.amazon.com/IllumiSea-Lumen-Underwater-Attracting-Saltwater/dp/> (Year: 2017).*

(Continued)

Primary Examiner — Eric L Goodman

Assistant Examiner — Sarah L Smith

(74) *Attorney, Agent, or Firm* — QuickPatents; Kevin Prince

(57)

CLAIM

I claim the ornamental design for a fishing light, as shown and described.

(56) **References Cited**

U.S. PATENT DOCUMENTS

1,258,058 A * 3/1918 Stuefer B26B 19/46
362/115

D295,562 S * 5/1988 Fazzina D26/49

D300,870 S * 4/1989 Leung D26/40

D333,190 S 2/1993 Waldmann

D357,088 S * 4/1995 Grooms D26/42

5,436,815 A * 7/1995 Grooms F21L 14/026
362/216

D367,123 S * 2/1996 Blye D26/40

D375,571 S * 11/1996 Petruzzi D26/46

D391,653 S * 3/1998 Ford D26/37

D416,344 S 11/1999 Hawkins

D421,142 S * 2/2000 Bayat D26/42

D430,946 S 9/2000 MacAllister

D446,877 S 8/2001 Lester

D457,664 S 5/2002 Moriyama

D458,339 S * 6/2002 Cheong D22/134

DESCRIPTION

FIG. 1 is a perspective view of a fishing light, showing my new design;

FIG. 2 is a front elevational view thereof the rear elevational view being a mirror image thereof;

FIG. 3 is a left-side elevational view thereof;

FIG. 4 is a right-side elevational view thereof;

FIG. 5 is a top plan view thereof; and,

FIG. 6 is a bottom plan view thereof.

The broken lines showing a power cord depict environmental matter and form no part of the claimed design. The remaining broken lines depict portions of the fishing light that form no part of the claimed design.

1 Claim, 4 Drawing Sheets

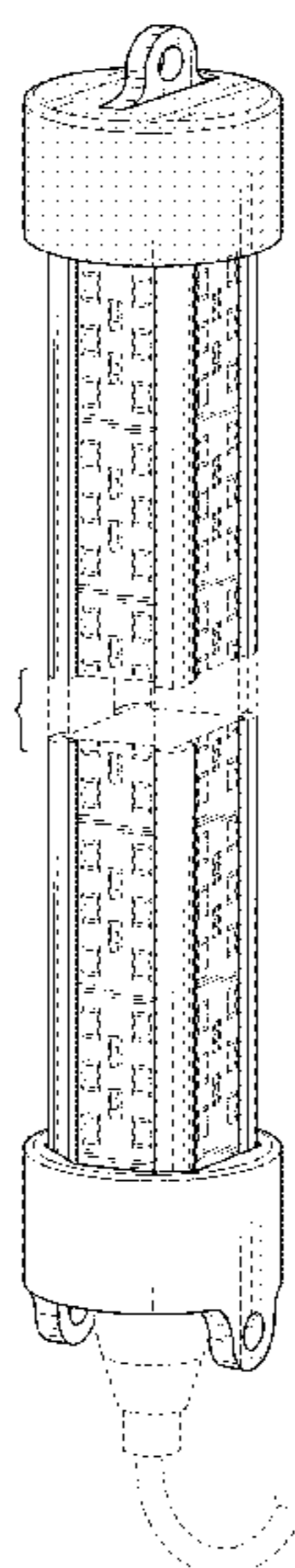

(56)

References Cited

U.S. PATENT DOCUMENTS

D505,217 S * 5/2005 Bayat D26/42
 D538,456 S 3/2007 Trigiani
 D551,369 S * 9/2007 Mah D26/37
 D553,770 S * 10/2007 Li D26/37
 D567,977 S 4/2008 Jianwei
 D567,978 S 4/2008 Jianwei
 7,367,689 B2 5/2008 Huang
 D593,695 S 6/2009 Levine
 D606,218 S * 12/2009 Jiang D26/42
 D612,086 S * 3/2010 Brauer D26/49
 D620,627 S 7/2010 Kovacic
 7,825,354 B2 11/2010 Flagle
 8,419,211 B2 4/2013 Chi
 D690,452 S 9/2013 Payne
 8,533,990 B2 9/2013 Aanenson et al.
 D694,446 S 11/2013 Zhou
 D701,986 S 4/2014 Goeckel
 D711,573 S * 8/2014 Payne D26/42
 D726,355 S 4/2015 Payne
 D805,669 S * 12/2017 Noga D26/51
 D805,699 S 12/2017 Noga
 D811,627 S * 2/2018 Roys F21K 9/278
 D26/3
 D811,635 S * 2/2018 Urry D26/42
 D835,314 S * 12/2018 Sun D26/43
 D875,286 S * 2/2020 Noga D26/42
 D884,945 S * 5/2020 Urry F21K 9/278
 D26/42
 D887,603 S * 6/2020 Noga F21L 14/026
 D26/42

D898,257 S * 10/2020 Noga F21V 9/30
 D26/43
 D901,318 S * 11/2020 Perkins D10/107
 D907,265 S * 1/2021 Wang F21L 14/023
 D26/41
 2003/0115787 A1 * 6/2003 Lindgren A01K 85/01
 43/17.6
 2004/0007980 A1 1/2004 Shibata
 2004/0111950 A1 * 6/2004 Lindgren A01K 85/01
 43/17.5
 2006/0198132 A1 9/2006 Trigiani
 2010/0033968 A1 2/2010 Kachkin
 2013/0135852 A1 5/2013 Chan
 2013/0250558 A1 * 9/2013 Griffin F21V 9/30
 362/183
 2013/0333270 A1 12/2013 Castaneda
 2015/0173337 A1 6/2015 Reed
 2016/0021857 A1 1/2016 Lin
 2016/0360585 A1 * 12/2016 Urry F21L 4/02
 2017/0122536 A1 * 5/2017 Noga A01K 97/02
 2018/0192631 A1 * 7/2018 Noga F21K 9/20

OTHER PUBLICATIONS

“LED Night Fishing Light,” Feb. 18, 2019, amazon.com, site visited Aug. 12, 2021, URL: <https://www.amazon.com/Night-Fishing-Light-10-8W-Attracting/dp/B07NVNW286> (Year: 2019).*
 “Marker 69—Shrimping/Fishing Lights & Nets On-line Store,” Mar. 26, 2019, facebook.com, site visited Aug. 12, 2021, URL: <https://www.facebook.com/Marker-69-ShrimpingFishing-Lights-Nets-On-line-Store-311275099218126/photos/829159464096351> (Year: 2019).*

* cited by examiner

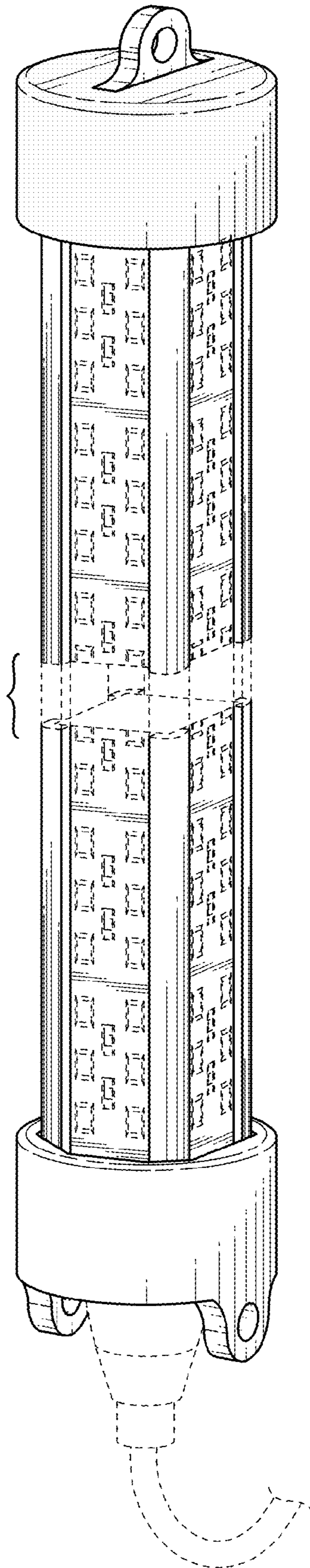

FIG. 1

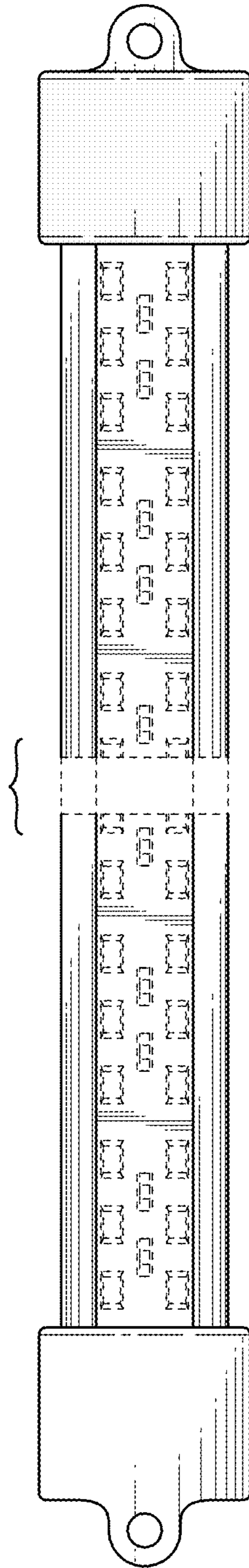

FIG. 2

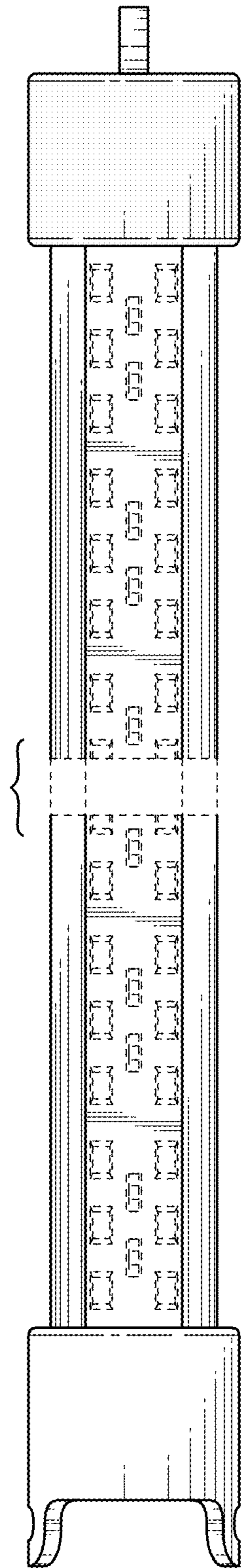

FIG. 3

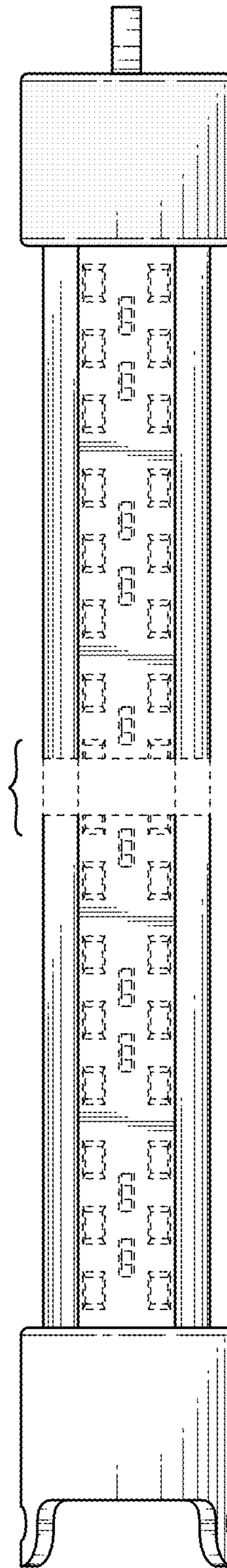

FIG. 4

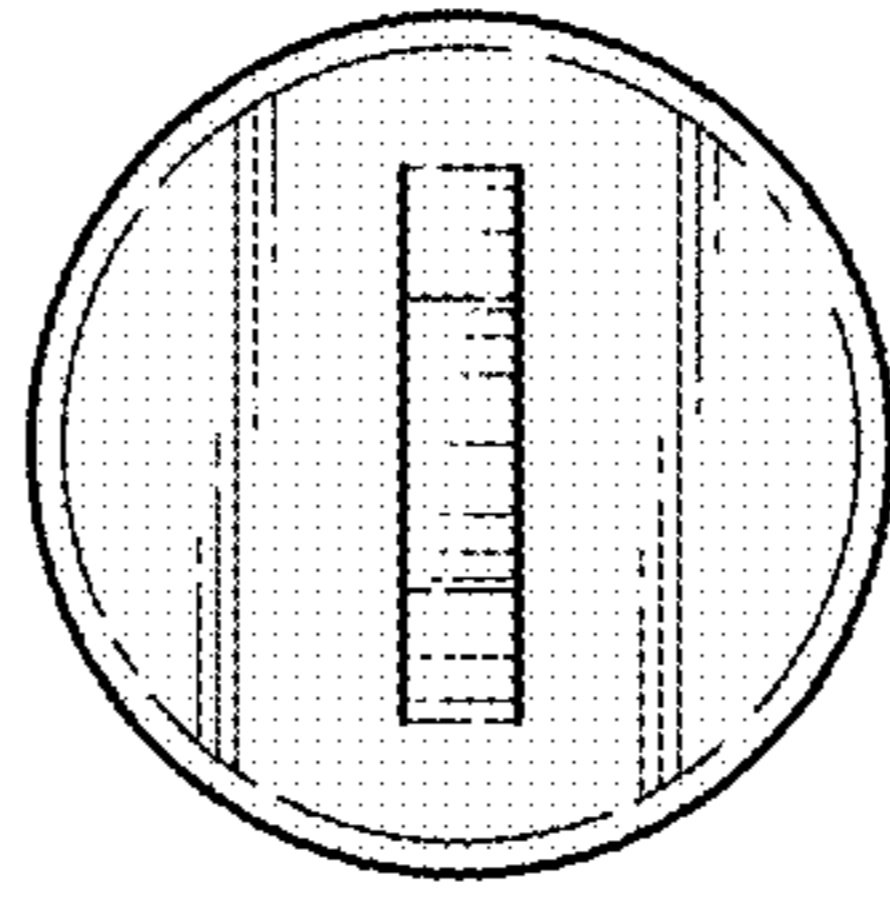

FIG. 5

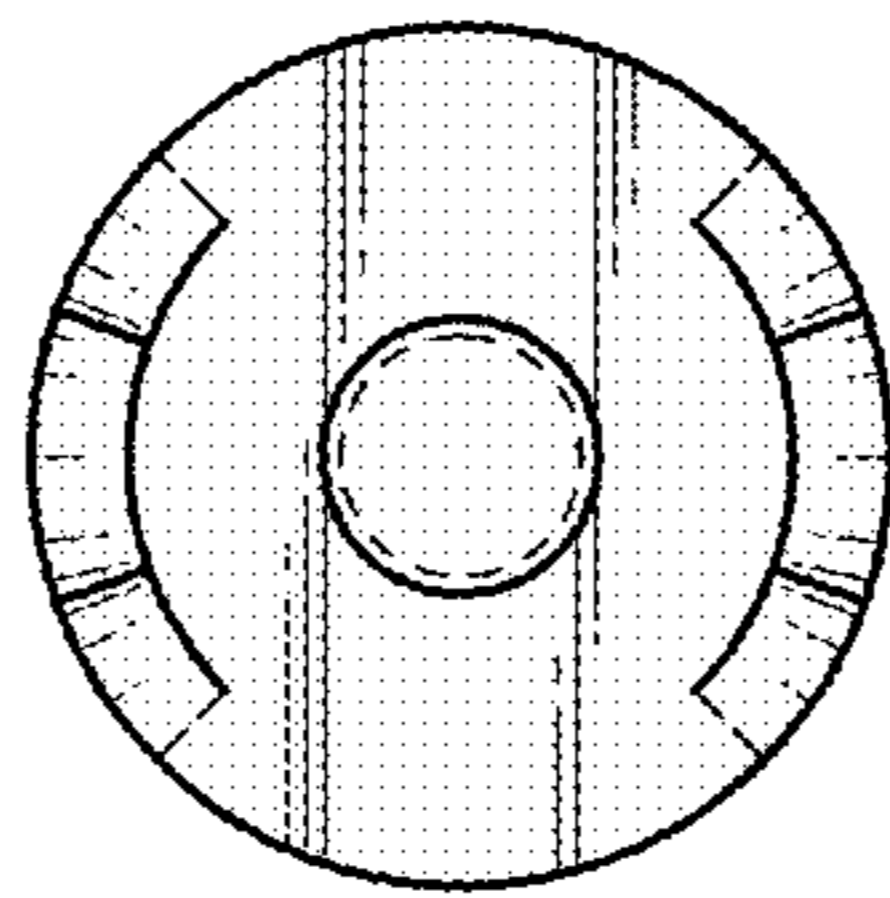

FIG. 6