



US00D932561S

(12) **United States Design Patent** (10) **Patent No.:** **US D932,561 S**
Chen (45) **Date of Patent:** **** Oct. 5, 2021**

(54) **TOY RACECAR**
(71) Applicant: **Bo Chen**, Guangdong (CN)
(72) Inventor: **Bo Chen**, Guangdong (CN)
(73) Assignee: **Shantou P&C Plastic Products Company Limited**, Shantou (CN)

D727,208 S * 4/2015 Allison D12/88
D807,787 S * 1/2018 Allison D12/88
D871,512 S * 12/2019 Cai D21/550
D881,068 S * 4/2020 Resta D12/88
2011/0177754 A1* 7/2011 Nakayama A63H 17/262
446/465
2015/0352455 A1* 12/2015 Karasanti A63H 17/00
446/448

(**) Term: **15 Years**
(21) Appl. No.: **29/689,934**
(22) Filed: **May 3, 2019**

FOREIGN PATENT DOCUMENTS

CN 303623433 * 3/2016
CN 303988952 * 12/2016
CN 305479993 * 12/2019

(30) **Foreign Application Priority Data**

Dec. 27, 2018 (CN) 201830759544.5

(51) **LOC (13) Cl.** **21-01**
(52) **U.S. Cl.**
USPC **D21/549**

(58) **Field of Classification Search**
USPC D21/433, 434, 483, 533-562; D12/82,
D12/86, 90, 92; 446/431, 471, 454-456
CPC B62D 25/00; B62D 35/00; A63H 17/262;
A63H 17/00; A63H 17/395; A63H 17/38;
A63H 17/26; A63H 17/28
See application file for complete search history.

OTHER PUBLICATIONS

Growsland Remote Control Car, RC Cars Xmas Gifts for kids, Earliest Available Date May 1, 2017 [Online], [Site Visited Oct. 7, 2020] Available From Internet, URL in PDF (Year: 2017).*

(Continued)

Primary Examiner — Jennifer L Rempfer
(74) *Attorney, Agent, or Firm* — Minder Law Group;
Willy H. Wong

(57) **CLAIM**

The ornamental design for a toy racecar, as shown and described.

DESCRIPTION

FIG. 1 is a front view of a toy racecar in accordance with the present invention.

FIG. 2 is a back view thereof.

FIG. 3 is a right view thereof.

FIG. 4 is a left view thereof.

FIG. 5 is a top view thereof; and,

FIG. 6 is a bottom view thereof.

The broken lines show portions of the toy racecar that form no part of the claimed design.

1 Claim, 6 Drawing Sheets

(56) **References Cited**

U.S. PATENT DOCUMENTS

D260,913 S * 9/1981 Chapman D12/88
D318,081 S * 7/1991 Yoshino D21/550
D319,853 S * 9/1991 Southgate D21/549
D424,132 S * 5/2000 Wei D21/550
D496,075 S * 9/2004 Byrne D21/550
D513,630 S * 1/2006 Wei D21/550
D575,356 S * 8/2008 Martino D21/550
D617,851 S * 6/2010 Stoddard D21/549
D665,306 S * 8/2012 Tombazis D12/88
D690,372 S * 9/2013 Fujiwara D21/550

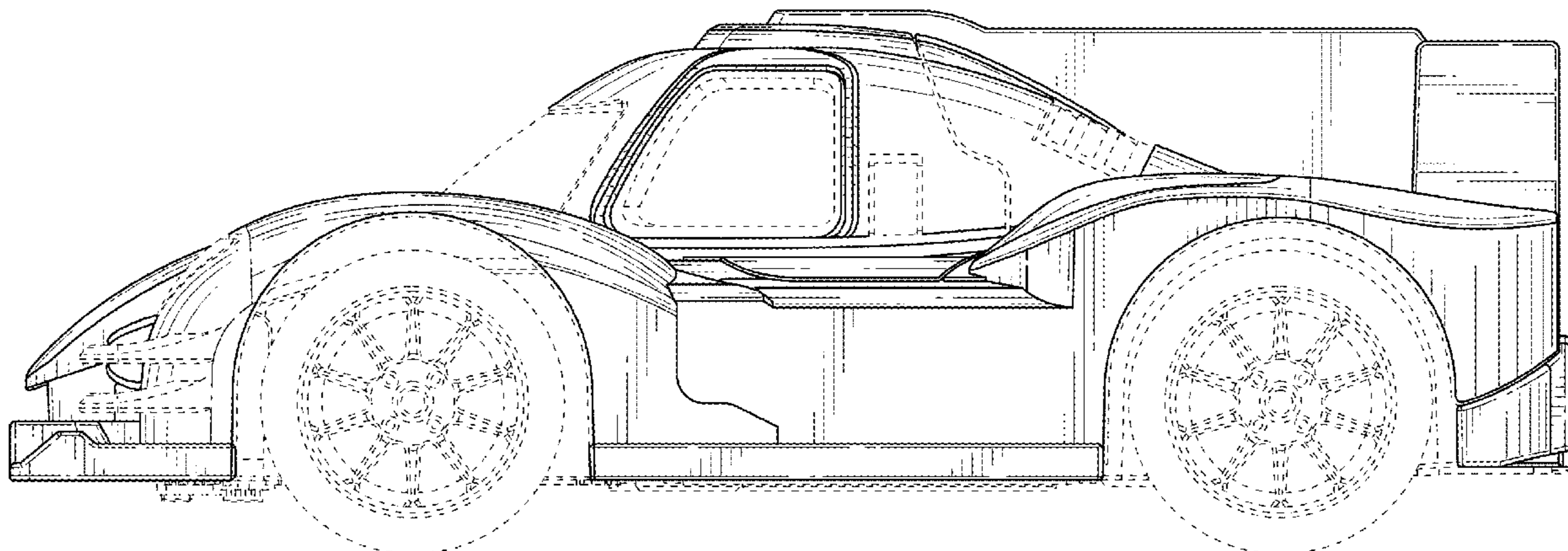

(56)

References Cited

OTHER PUBLICATIONS

Kidzlane Remote Control Cars—2 Pack Race Cars with All-Direction Drive and 35 Foot Range, Earliest Available Date Jun. 29, 2020 [Online], [Site Visited Oct. 7, 2020] Available From Internet, URL in PDF (Year: 2020).*

* cited by examiner

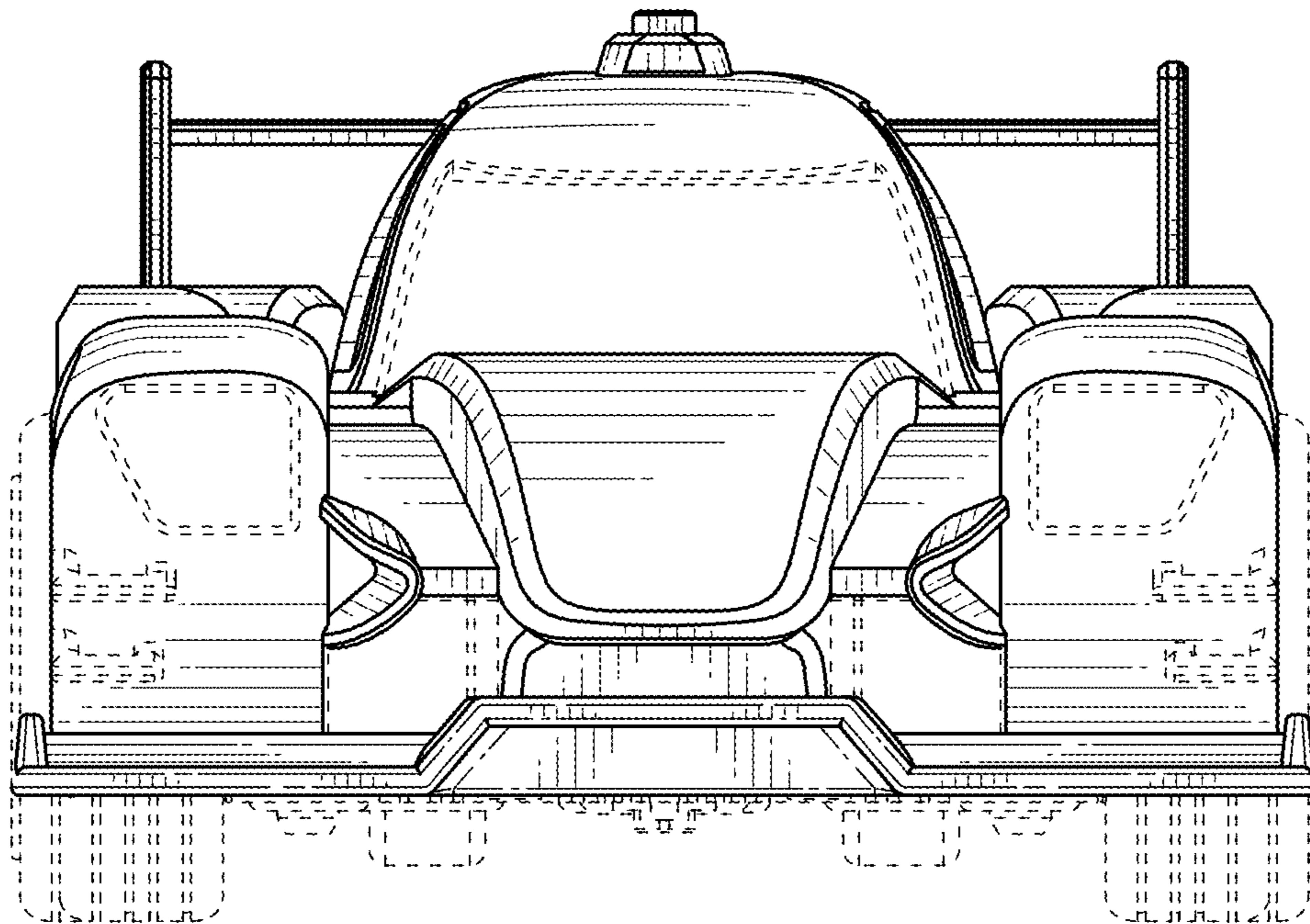

FIG. 1

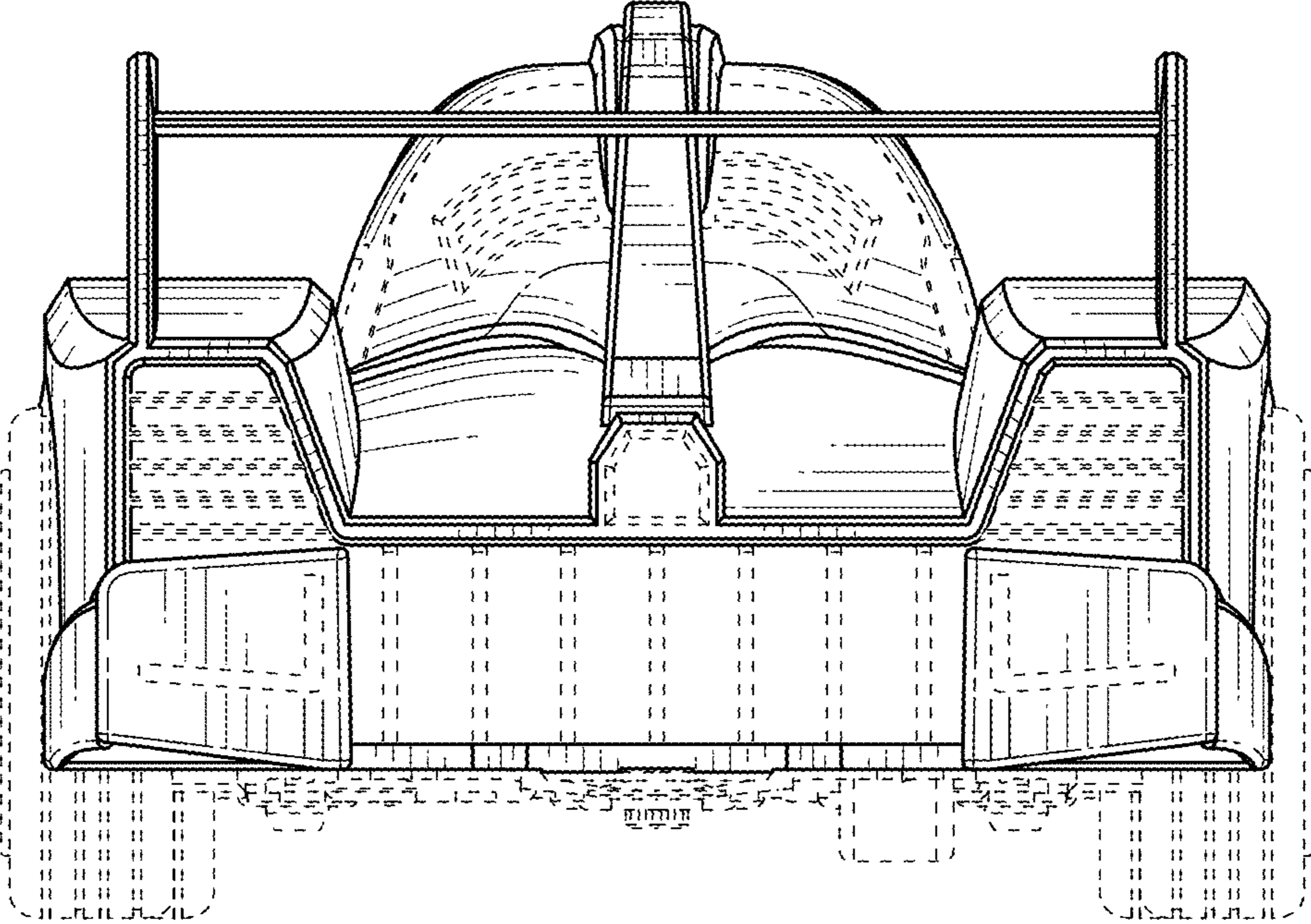

FIG. 2

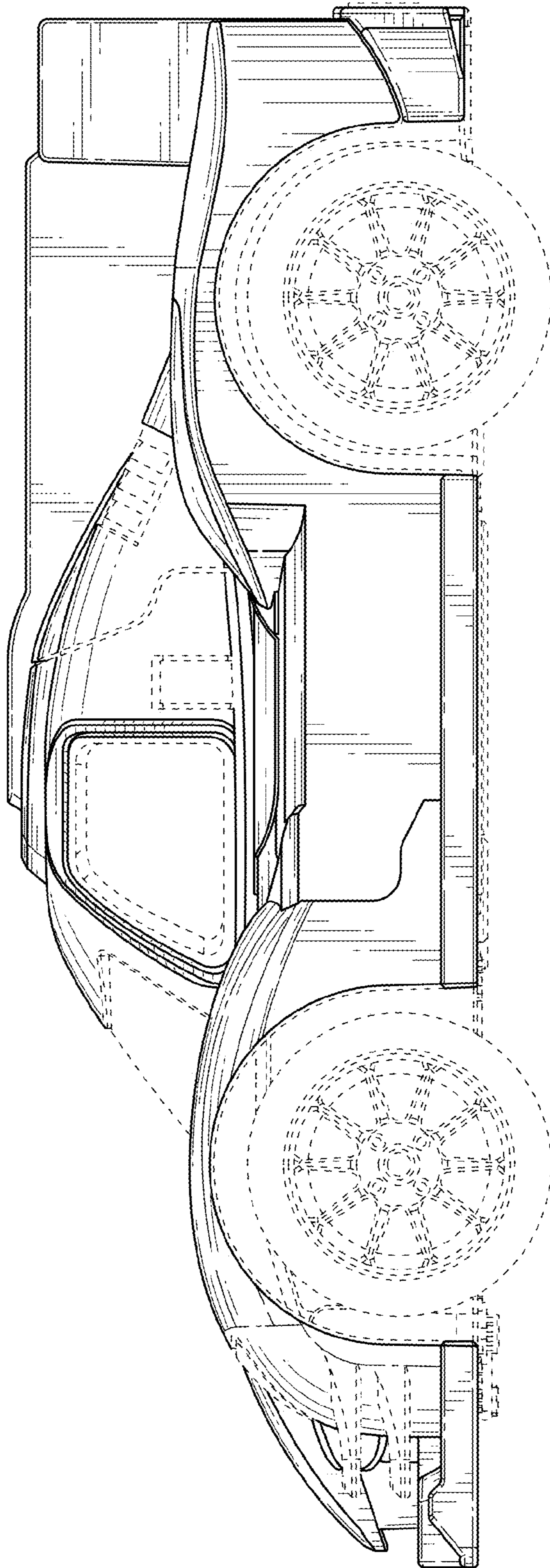

FIG. 3

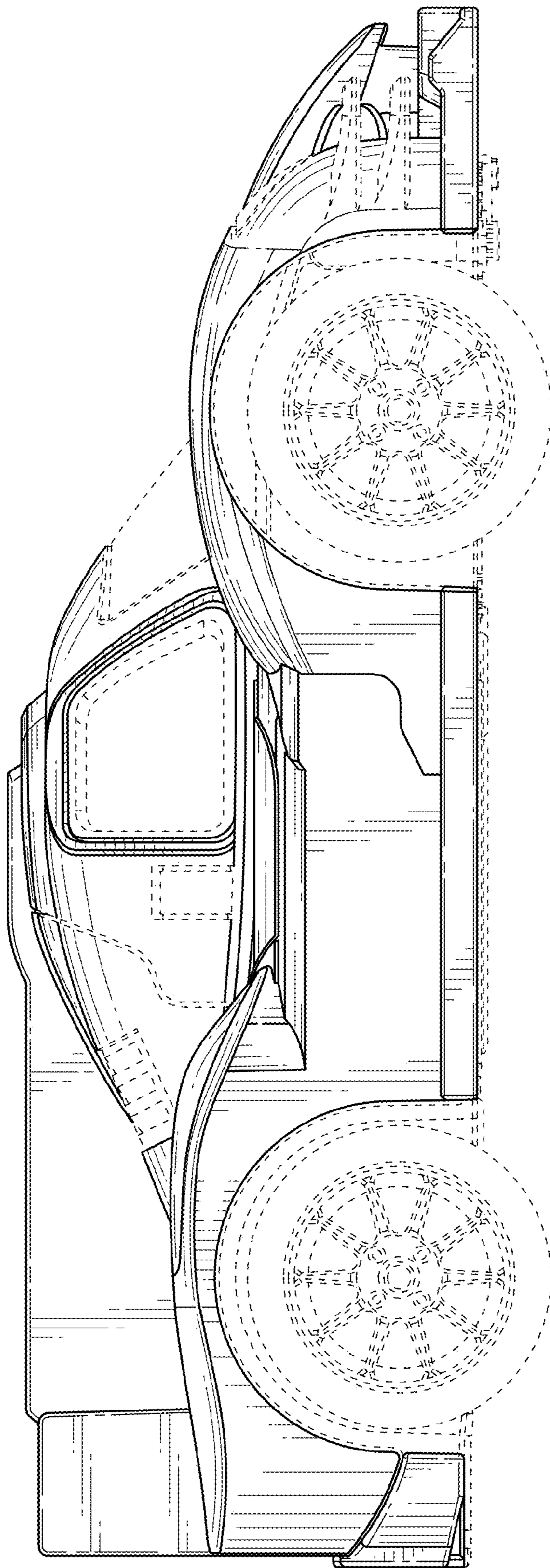

FIG. 4

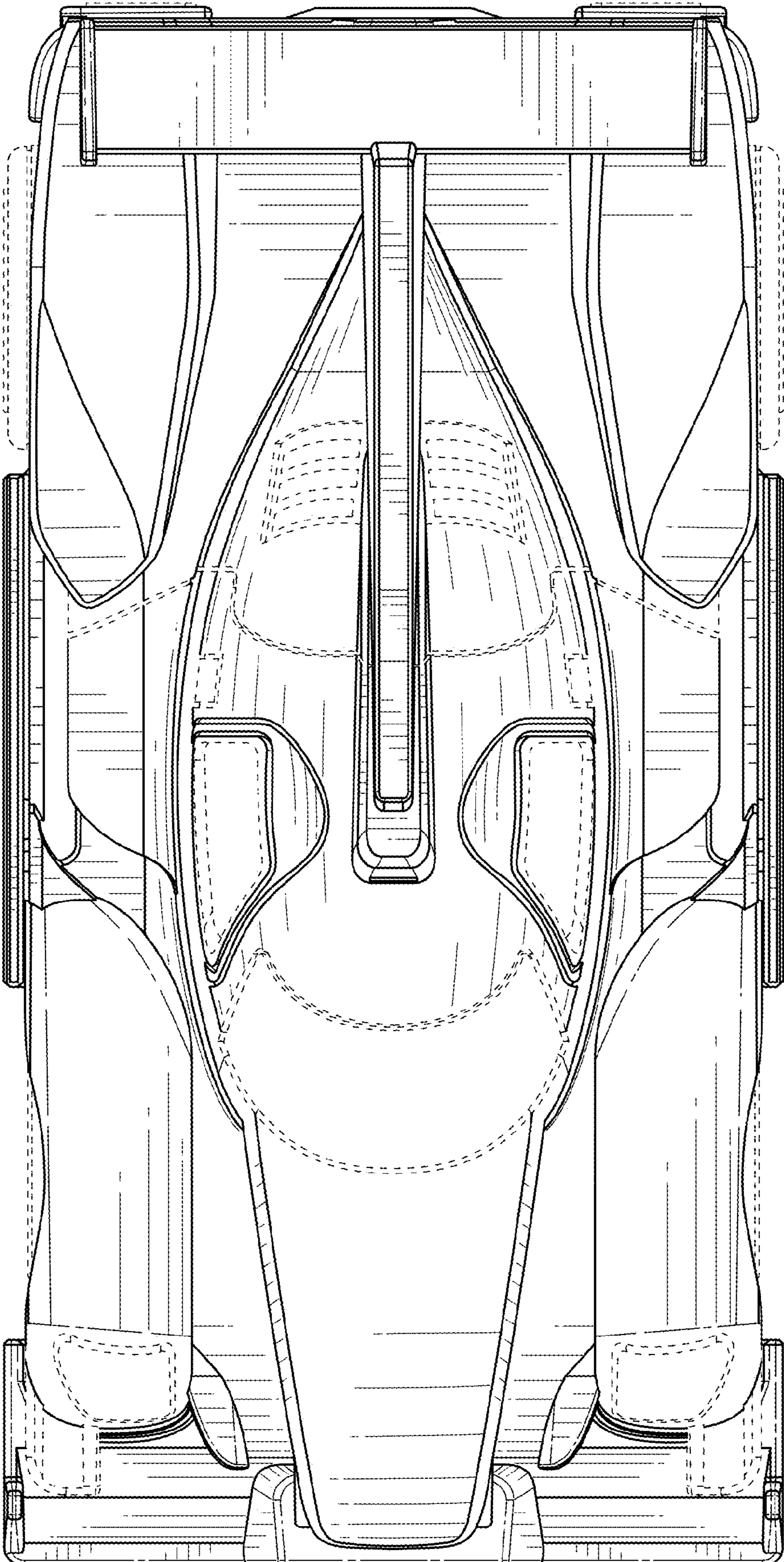

FIG. 5

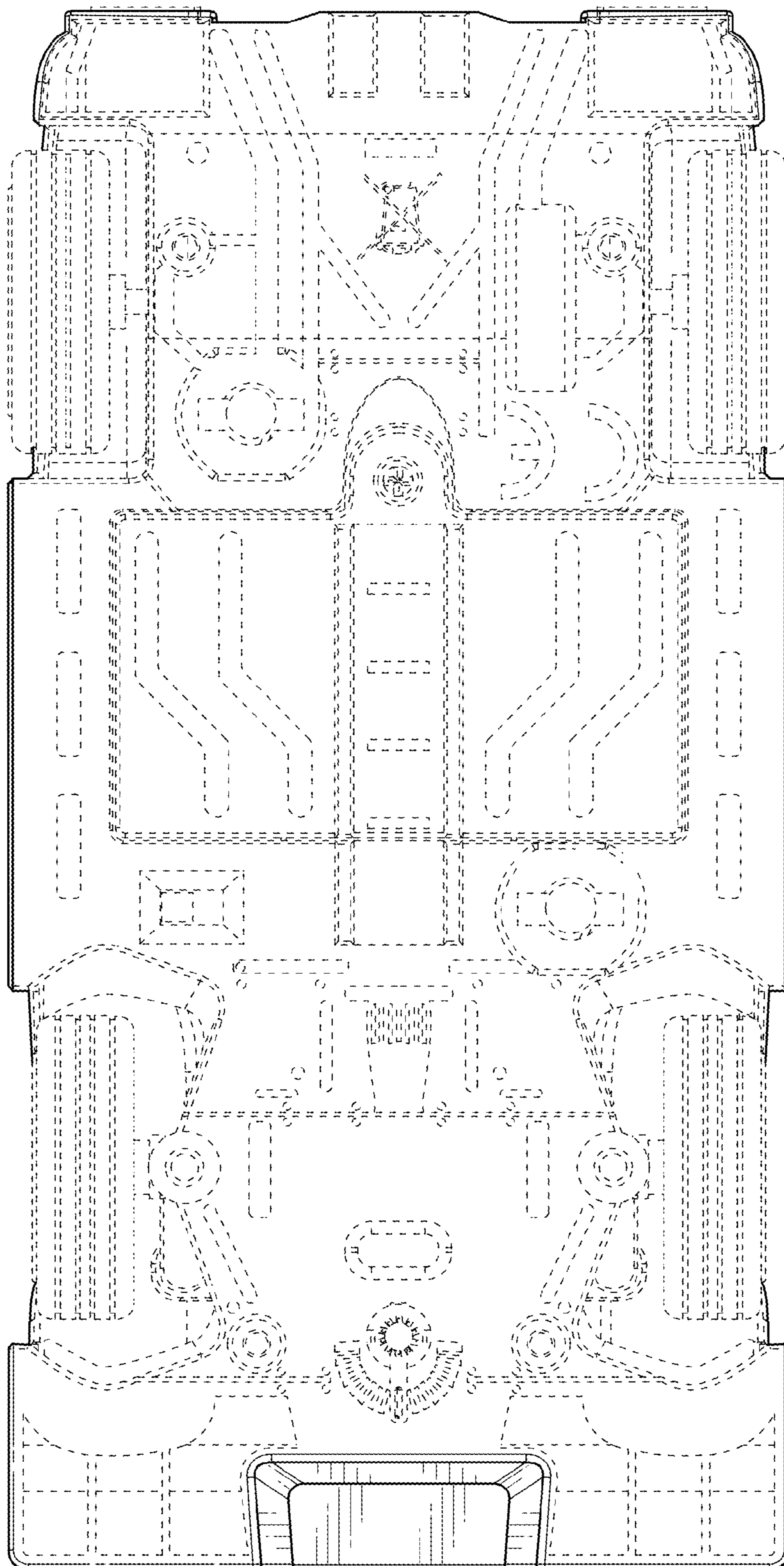

FIG. 6