

US00D932528S

(12) **United States Design Patent** (10) **Patent No.:** **US D932,528 S**
Huang (45) **Date of Patent:** **** Oct. 5, 2021**

(54) **CONCRETE MOLD**

D700,803 S * 3/2014 Hamlin D7/409
D802,928 S * 11/2017 Serimian D3/313
D907,669 S * 1/2021 Chen D15/136

(71) Applicant: **Zhaoqing Jinchao Energy Saving Technology Co., Ltd.**, Guangdong (CN)

* cited by examiner

(72) Inventor: **Weitian Huang**, Guangdong (CN)

Primary Examiner — Patricia A Palasik

(73) Assignee: **Zhaoqing Jinchao Energy Saving Technology Co., Ltd.**, Guangdong (GN)

(74) *Attorney, Agent, or Firm* — ScienBiziP, P.C.

(**) Term: **15 Years**

(21) Appl. No.: **29/761,761**

(22) Filed: **Dec. 11, 2020**

(51) **LOC (13) Cl.** **15-09**

(52) **U.S. Cl.**

USPC **D15/136**

(58) **Field of Classification Search**

USPC D15/135, 136

CPC E01C 19/43; E01C 19/22

See application file for complete search history.

(56) **References Cited**

U.S. PATENT DOCUMENTS

D204,803 S * 5/1966 Leeth D15/136
D356,803 S * 3/1995 Hupp D15/136
5,487,526 A * 1/1996 Hupp B28B 7/24
249/129
D379,359 S * 5/1997 Hupp D15/136
D475,375 S * 6/2003 Curry D15/136
D657,405 S 4/2012 Kinzalow
D679,300 S 4/2013 Hammer

(57) **CLAIM**

The ornamental design for a concrete mold, as shown and described.

DESCRIPTION

FIG. 1 is a top perspective view of a concrete mold, showing my design.

FIG. 2 is a bottom perspective view of the concrete mold.

FIG. 3 is a front elevation view thereof.

FIG. 4 is a rear elevation view thereof.

FIG. 5 is a left side elevation view thereof.

FIG. 6 is a right side elevation view thereof.

FIG. 7 is a top plan view thereof.

FIG. 8 is a bottom plan view thereof.

FIG. 9 is an enlarged view of an area labeled 9 in FIG. 1; and,

FIG. 10 is an enlarged view of an area labeled 10 in FIG. 2.

The broken lines in the drawings depict portions of the concrete mold that form no part of the claimed design.

1 Claim, 10 Drawing Sheets

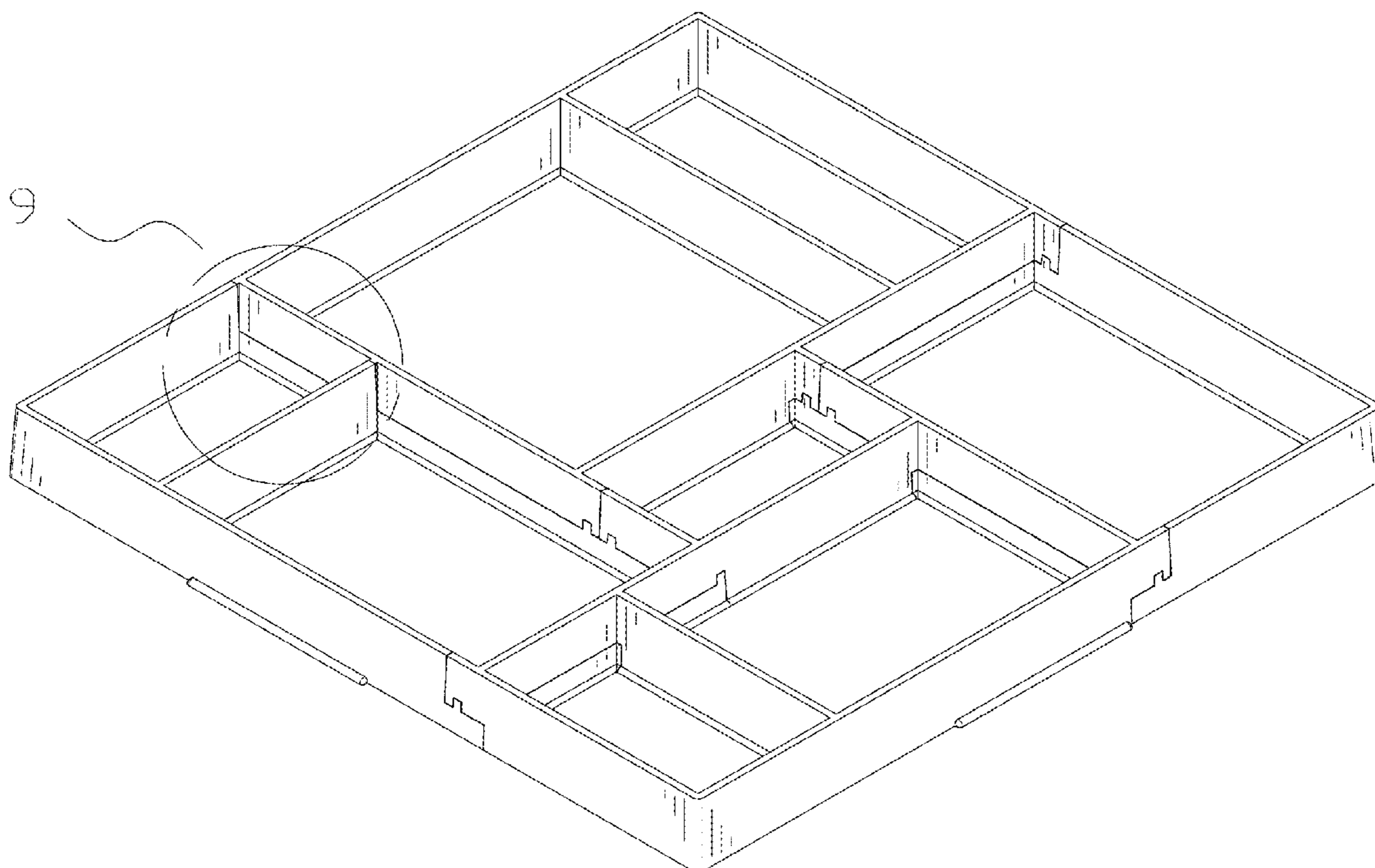

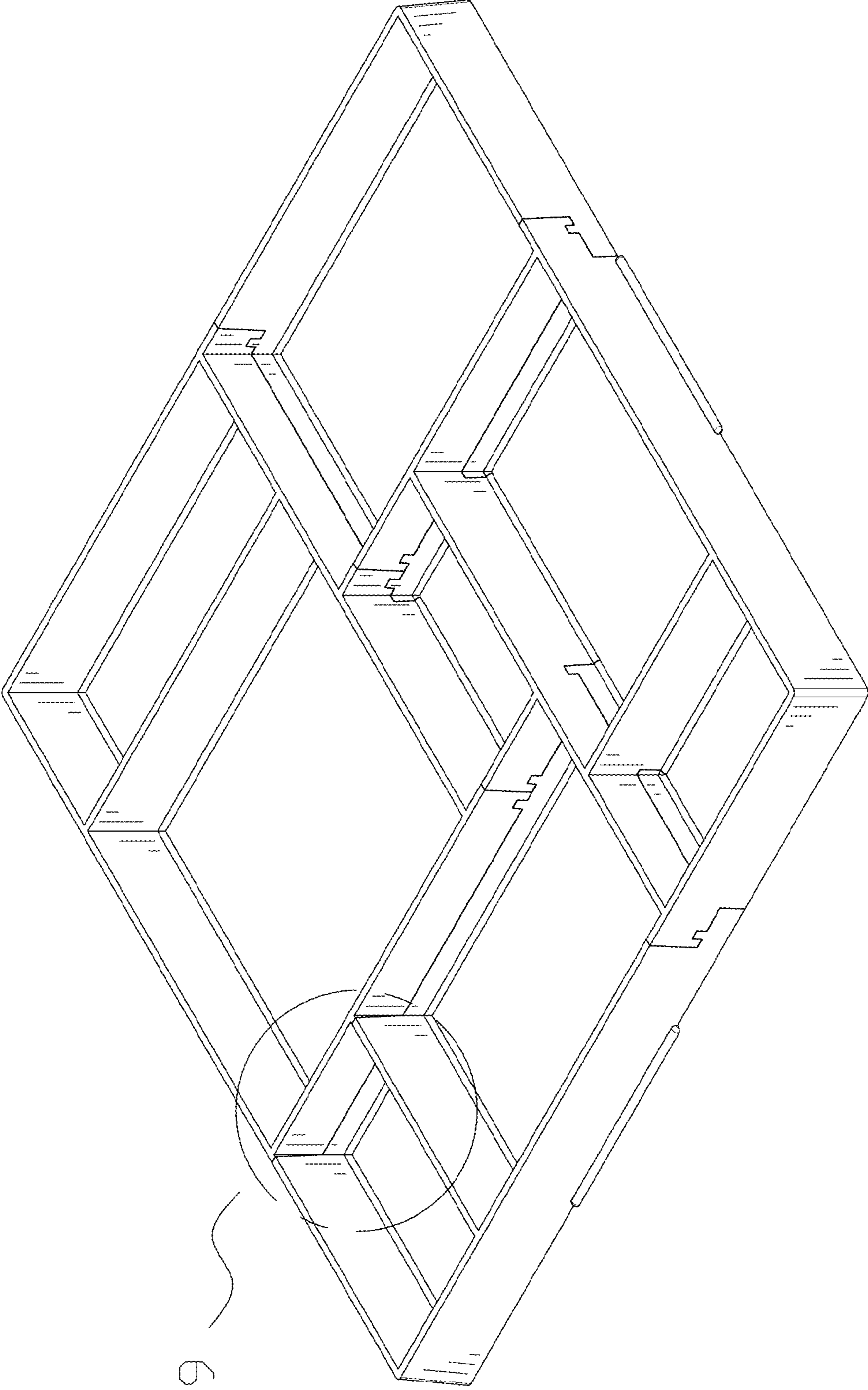

FIG.1

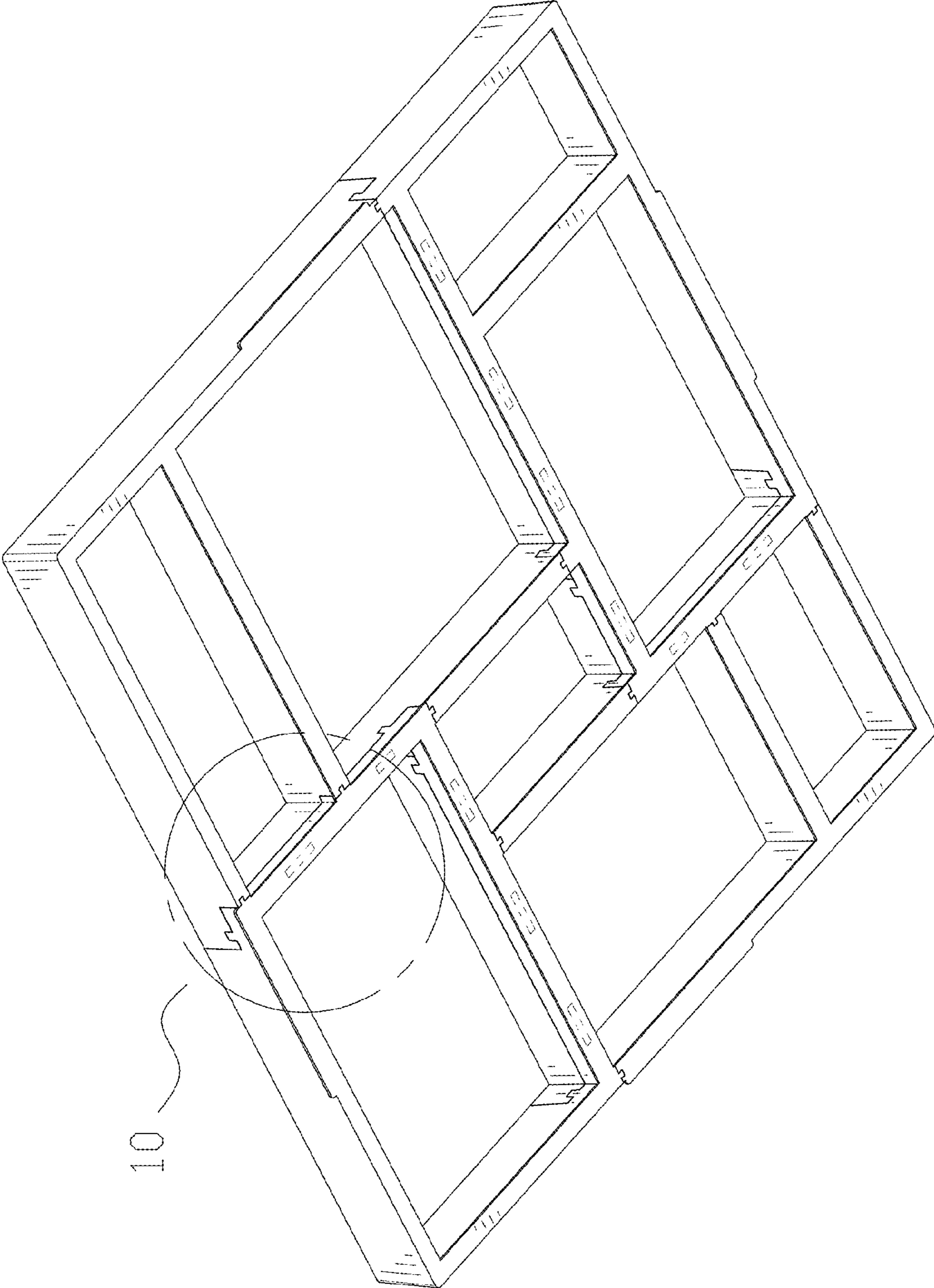

FIG. 2

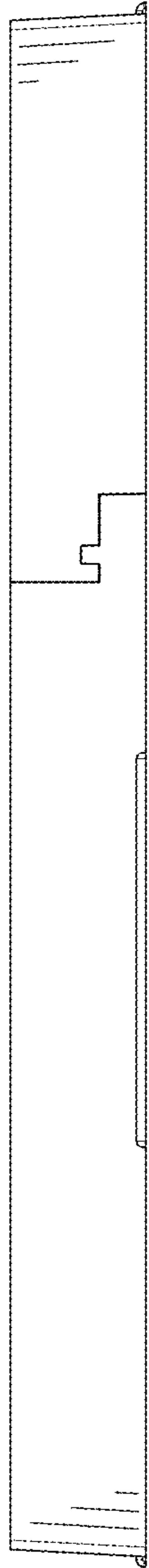

FIG. 3

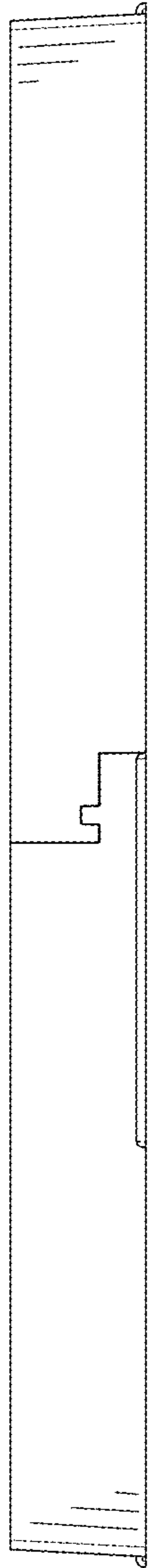

FIG. 4

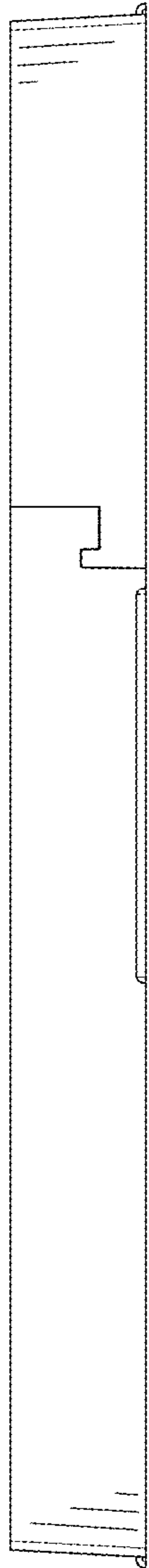

FIG. 5

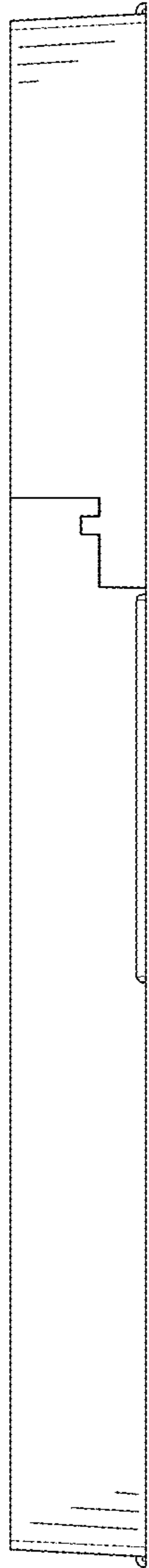

FIG. 6

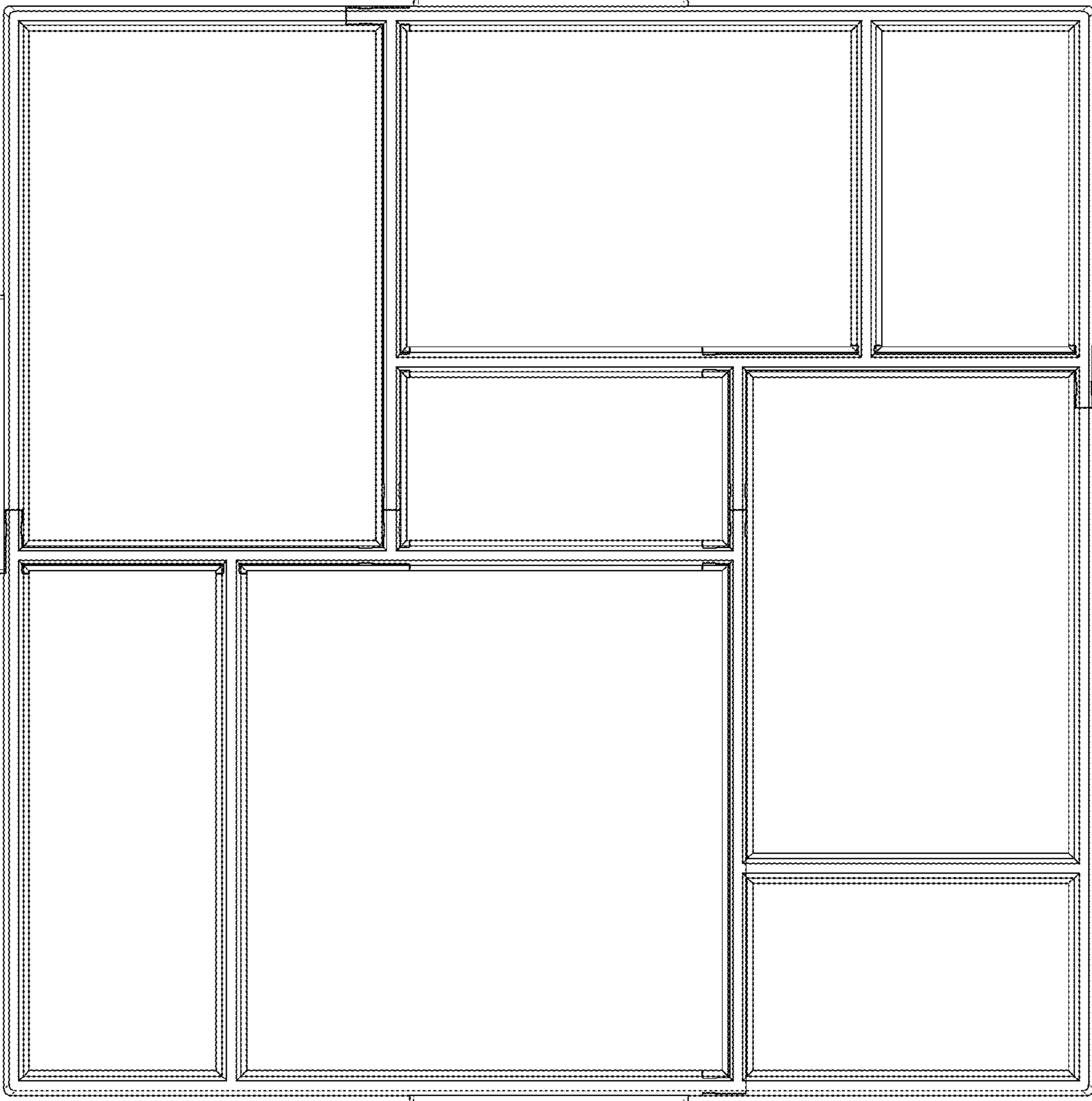

FIG. 7

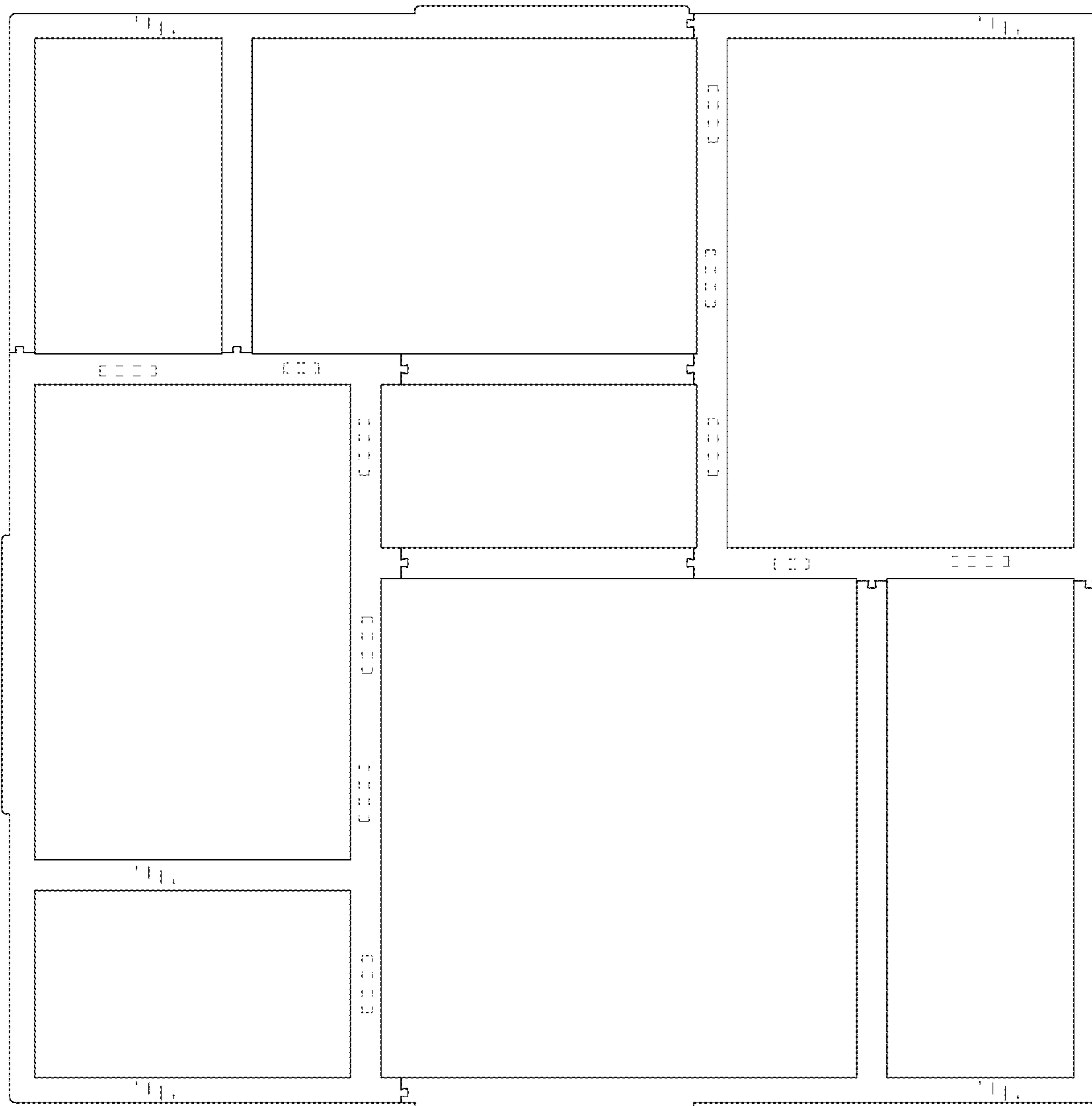

FIG. 8

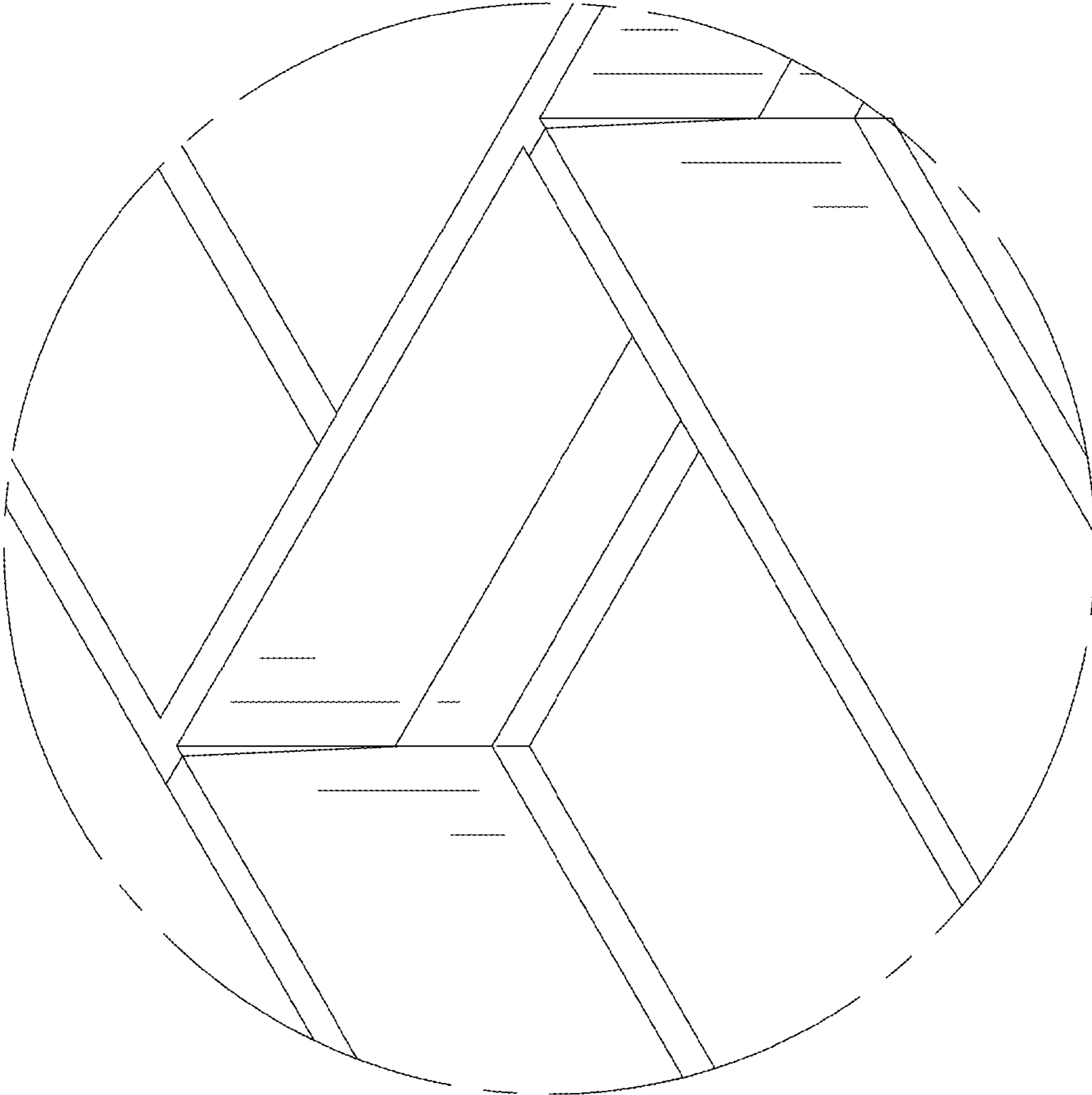

FIG. 9

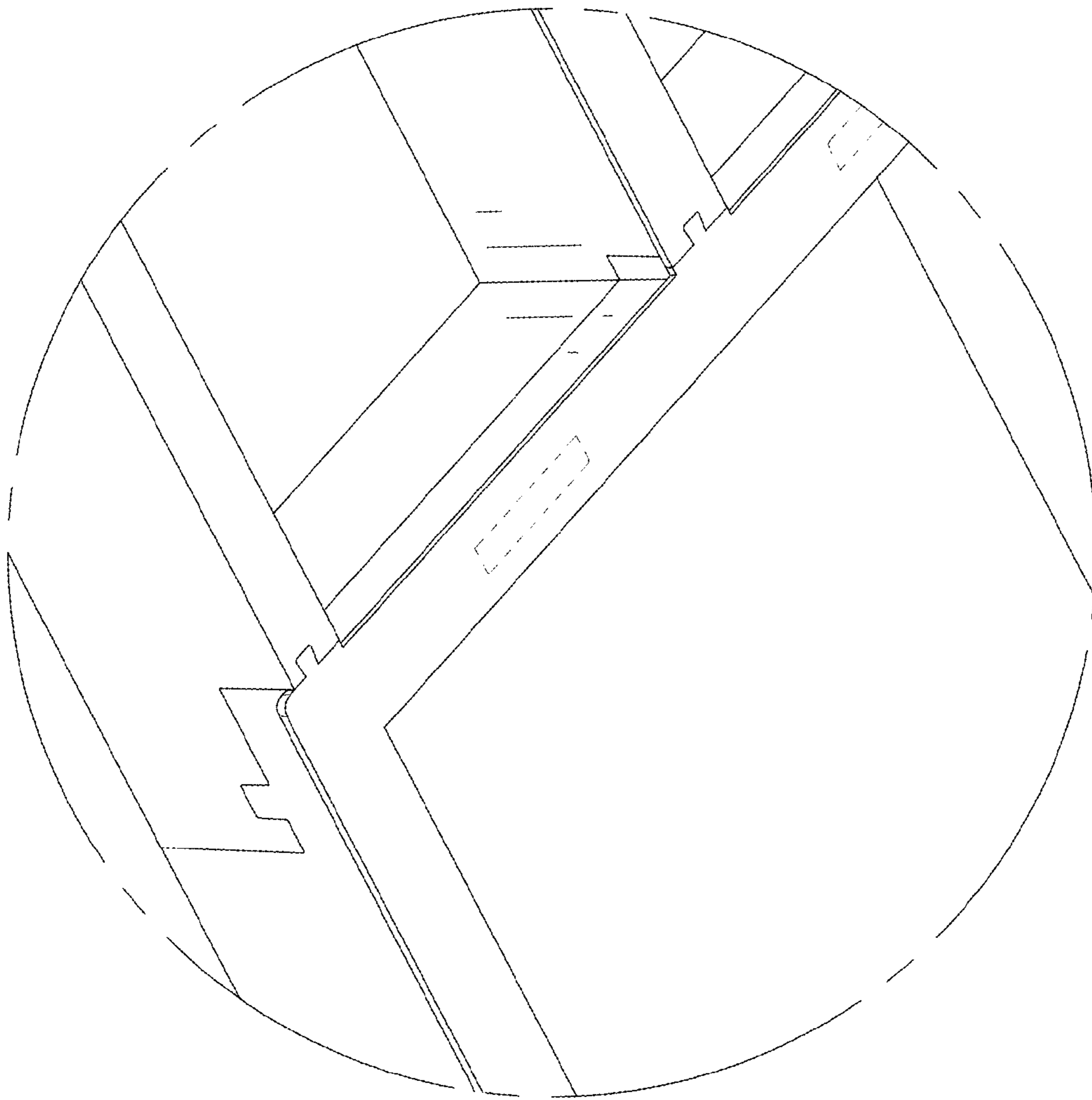

FIG.10