



US00D932468S

(12) **United States Design Patent** (10) **Patent No.:** **US D932,468 S**  
**Xin** (45) **Date of Patent:** **\*\* Oct. 5, 2021**

(54) **EARPHONES WITH CHARGING CASE**

FOREIGN PATENT DOCUMENTS

(71) Applicant: **SHENZHEN MAGIO ELECTRONIC CO., LIMITED**, Shenzhen (CN)

CN 306100502 \* 10/2020  
EM 008322028-0001 \* 12/2020  
EM 008520050-0001 \* 4/2021

(72) Inventor: **Yongxian Xin**, Shenzhen (CN)

*Primary Examiner* — Paula Allen Greene

(73) Assignee: **SHENZHEN MAGIO ELECTRONIC CO., LIMITED**, Shenzhen (CN)

(57) **CLAIM**

The ornamental design for earphones with charging case, as shown and described.

(\*\*) Term: **15 Years**

**DESCRIPTION**

(21) Appl. No.: **29/768,711**

(22) Filed: **Feb. 1, 2021**

(51) **LOC (13) Cl.** ..... **14-01**

(52) **U.S. Cl.**  
USPC ..... **D14/223**

(58) **Field of Classification Search**  
USPC ..... D14/223, 205; D13/108; D3/201, 295, D3/294, 218; D9/424, 529, 420, 521, D9/734; D28/76, 66, 78, 83; 206/702; 220/4.22; 132/301, 295; D24/174; 128/864, 865, 866; 381/380, 381, 322, 381/328, 323; 320/110  
CPC ..... H02J 7/02; B65D 25/10; B65D 25/02; H04R 25/00; H04R 25/02; H04R 1/1066; H04R 1/1016; H04R 5/033; H04R 5/0335; H04R 1/10

See application file for complete search history.

FIG. 1 is a perspective view of earphones of earphones with charging case, shown separately for ease of illustration; FIG. 2 is another perspective view thereof; FIG. 3 is a front elevational view thereof; FIG. 4 is a rear elevational view thereof; FIG. 5 is a left side elevational view thereof; FIG. 6 is a right side elevational view thereof; FIG. 7 is a top plan view thereof; FIG. 8 is a bottom plan view thereof; FIG. 9 is a perspective view of a charging case of the earphones with charging case, shown separately for ease of illustration and in an open configuration; FIG. 10 is another perspective view thereof; FIG. 11 is a front elevational view thereof; FIG. 12 is a rear elevational view thereof; FIG. 13 is a left side elevational view thereof; FIG. 14 is a right side elevational view thereof; FIG. 15 is a top plan view thereof; FIG. 16 is a bottom plan view thereof; FIG. 17 is a perspective view of the earphones with charging case, shown in use with the earphones received in the charging case; and, FIG. 18 is a perspective view of the charging case of the earphones with the charging case, shown separately for ease of illustration and in a closed configuration. The broken lines in the drawings depict portions of the earphones with charging case that form no part of the claimed design.

(56) **References Cited**

U.S. PATENT DOCUMENTS

6,837,372 B1 \* 1/2005 Aramaki ..... G11B 33/0438  
206/308.3  
D589,498 S \* 3/2009 Komiyama ..... D14/223  
D590,371 S \* 4/2009 Leinvuo ..... D14/205  
D633,086 S \* 2/2011 Chen ..... D14/223  
D641,738 S \* 7/2011 Perez ..... D14/223

(Continued)

**1 Claim, 18 Drawing Sheets**

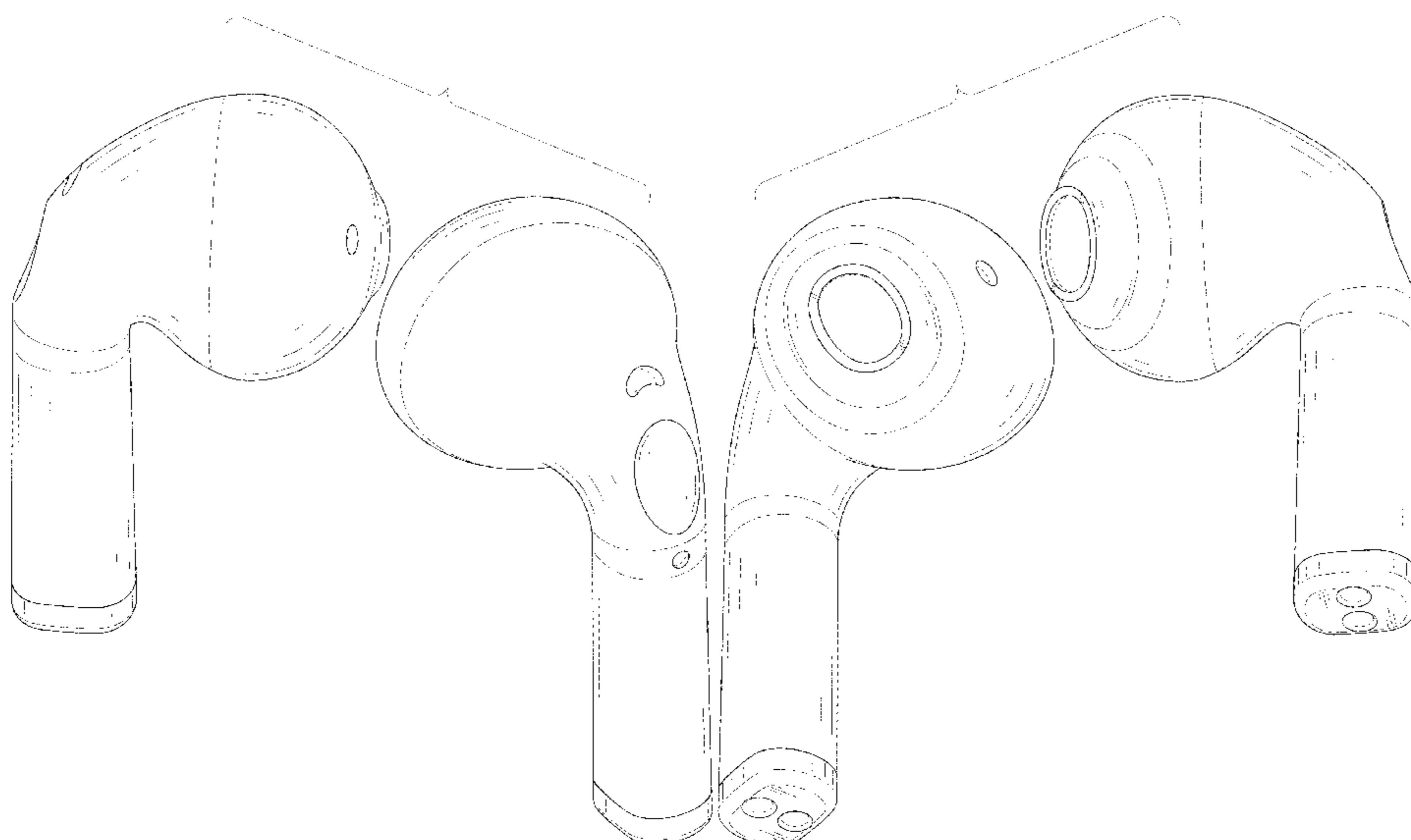

(56)

References Cited

U.S. PATENT DOCUMENTS

D651,196 S \* 12/2011 Quek ..... D14/223  
 D652,823 S \* 1/2012 Chen ..... H04R 1/1016  
 D660,290 S \* 5/2012 Weedon ..... D14/223  
 D662,493 S \* 6/2012 Chen ..... D14/223  
 D662,495 S \* 6/2012 Andre ..... D14/223  
 D664,523 S \* 7/2012 Naitou ..... D14/223  
 D666,581 S \* 9/2012 Perez ..... D14/223  
 D671,531 S \* 11/2012 Kim ..... D14/223  
 D674,688 S \* 1/2013 Loftin ..... D9/428  
 D681,015 S \* 4/2013 Akana ..... H04R 1/10  
 D695,721 S \* 12/2013 Thompson ..... D14/223  
 D707,206 S \* 6/2014 Akana ..... H04R 1/10  
 D711,857 S \* 8/2014 Burgett ..... D14/223  
 D718,284 S \* 11/2014 Shibusawa ..... D14/223  
 D730,876 S \* 6/2015 Dahlberg ..... D14/223  
 D732,008 S \* 6/2015 Akana ..... H04R 1/10  
 D733,101 S \* 6/2015 Pi ..... D14/223  
 D733,689 S \* 7/2015 Narita ..... D14/223  
 D738,864 S \* 9/2015 Lee ..... D14/223  
 D741,287 S \* 10/2015 Harata ..... D14/205  
 D757,682 S \* 5/2016 Perez ..... D14/205  
 D760,202 S \* 6/2016 Hsieh ..... D14/223  
 D770,412 S \* 11/2016 Son ..... D14/205  
 D784,962 S \* 4/2017 Yang ..... D14/223  
 D801,314 S \* 10/2017 Akana ..... D14/223  
 D801,962 S \* 11/2017 Smith ..... D14/307  
 D806,388 S \* 1/2018 Akana ..... D3/294  
 D808,791 S \* 1/2018 Johnston ..... D9/420  
 D810,431 S \* 2/2018 Kim ..... D3/266  
 D818,268 S \* 5/2018 Akana ..... D3/294  
 D820,809 S \* 6/2018 Akana ..... D14/205  
 D822,009 S \* 7/2018 Matoba ..... D14/223  
 D823,246 S \* 7/2018 Lin ..... D13/108  
 D826,852 S \* 8/2018 Hung ..... D13/108  
 D830,336 S \* 10/2018 Cai ..... D14/205  
 D832,824 S \* 11/2018 Kim ..... D14/223  
 D838,480 S \* 1/2019 Son ..... D3/294  
 D841,581 S \* 2/2019 Bonahoom ..... D13/108  
 D846,264 S \* 4/2019 Wu ..... D3/201  
 D847,125 S \* 4/2019 Akana ..... D14/223  
 D849,401 S \* 5/2019 Akana ..... D3/274  
 D853,116 S \* 7/2019 Bergman ..... D3/294  
 D853,357 S \* 7/2019 Li ..... D14/217  
 D861,647 S \* 10/2019 Chen ..... D14/223  
 D863,261 S \* 10/2019 Zhu ..... D14/223  
 D864,110 S \* 10/2019 Yoshimura ..... D13/108  
 D865,720 S \* 11/2019 Deng ..... D14/223  
 D869,445 S \* 12/2019 Hu ..... D14/223  
 D870,451 S \* 12/2019 Birger ..... D3/201

D877,722 S \* 3/2020 Yang ..... D14/223  
 D878,045 S \* 3/2020 Akana ..... D3/274  
 D878,048 S \* 3/2020 Wang ..... D3/294  
 D878,337 S \* 3/2020 Yang ..... D14/223  
 D881,572 S \* 4/2020 Wang ..... D3/294  
 D882,259 S \* 4/2020 Liu ..... D3/269  
 D882,553 S \* 4/2020 Wu ..... D14/223  
 D883,260 S \* 5/2020 Hu ..... D14/223  
 D885,373 S \* 5/2020 Lundback ..... D14/223  
 D886,453 S \* 6/2020 Wright ..... D3/294  
 D886,455 S \* 6/2020 Williamson ..... D3/294  
 D888,408 S \* 6/2020 Lee ..... D3/201  
 D890,725 S \* 7/2020 Liu .....  
 D893,166 S \* 8/2020 Lu ..... D3/201  
 D893,184 S \* 8/2020 Liu ..... D3/294  
 D896,206 S \* 9/2020 Xu ..... D14/223  
 D897,678 S \* 10/2020 Koh ..... D3/294  
 D897,997 S \* 10/2020 Zhang ..... D14/223  
 D897,998 S \* 10/2020 Ma ..... D14/223  
 D902,588 S \* 11/2020 Zhang ..... D3/294  
 D904,023 S \* 12/2020 Wang ..... D3/294  
 D904,025 S \* 12/2020 Ma ..... D3/295  
 D906,238 S \* 12/2020 Zhang ..... D13/108  
 D906,299 S \* 12/2020 Luo ..... D14/223  
 D907,008 S \* 1/2021 Yao ..... D14/223  
 D907,009 S \* 1/2021 Akana ..... D14/223  
 D907,606 S \* 1/2021 Lin ..... D14/223  
 D908,345 S \* 1/2021 He ..... D3/201  
 D908,617 S \* 1/2021 Briggs ..... D13/108  
 D910,553 S \* 2/2021 Cramer ..... D13/108  
 D910,601 S \* 2/2021 Hu ..... D14/223  
 D911,027 S \* 2/2021 Liang ..... D3/274  
 D912,622 S \* 3/2021 Zhou ..... D13/108  
 D913,223 S \* 3/2021 Li ..... D13/108  
 D916,683 S \* 4/2021 Yao ..... D14/223  
 D918,138 S \* 5/2021 Ma ..... D13/108  
 D921,615 S \* 6/2021 Wu ..... D14/223  
 D922,946 S \* 6/2021 Chen ..... D13/108  
 D922,996 S \* 6/2021 Chen ..... D14/315  
 D923,609 S \* 6/2021 Li ..... D14/223  
 D927,417 S \* 8/2021 Sretovic ..... D13/108  
 D927,465 S \* 8/2021 Wang ..... D14/223  
 2008/0090622 A1 \* 4/2008 Kim ..... H04M 1/05  
 455/573  
 2012/0155692 A1 \* 6/2012 Chen ..... H04R 1/1058  
 381/380  
 2012/0237074 A1 \* 9/2012 Aase ..... H04R 1/1075  
 381/380  
 2013/0004011 A1 \* 1/2013 Hayashida ..... H04R 1/345  
 381/380  
 2019/0373354 A1 \* 12/2019 Sondergaard ..... H01R 13/562  
 2020/0107098 A1 \* 4/2020 DiFonzo ..... H01F 41/0246  
 2020/0304898 A1 \* 9/2020 Cohen ..... H04R 1/02  
 2021/0021921 A1 \* 1/2021 Min, II ..... H04R 1/28  
 2021/0266654 A1 \* 8/2021 Ko ..... H04R 1/1075

\* cited by examiner

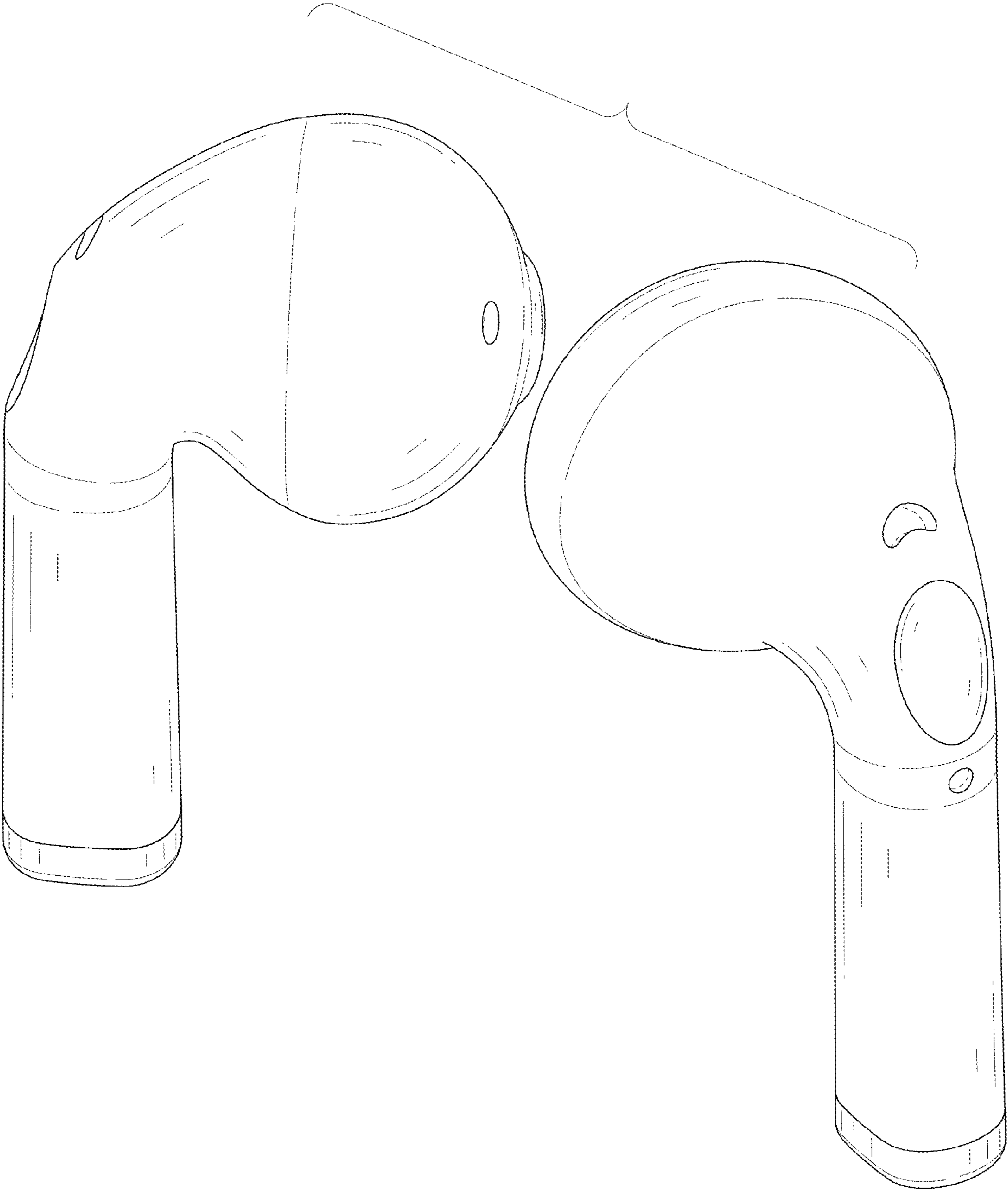

FIG. 1

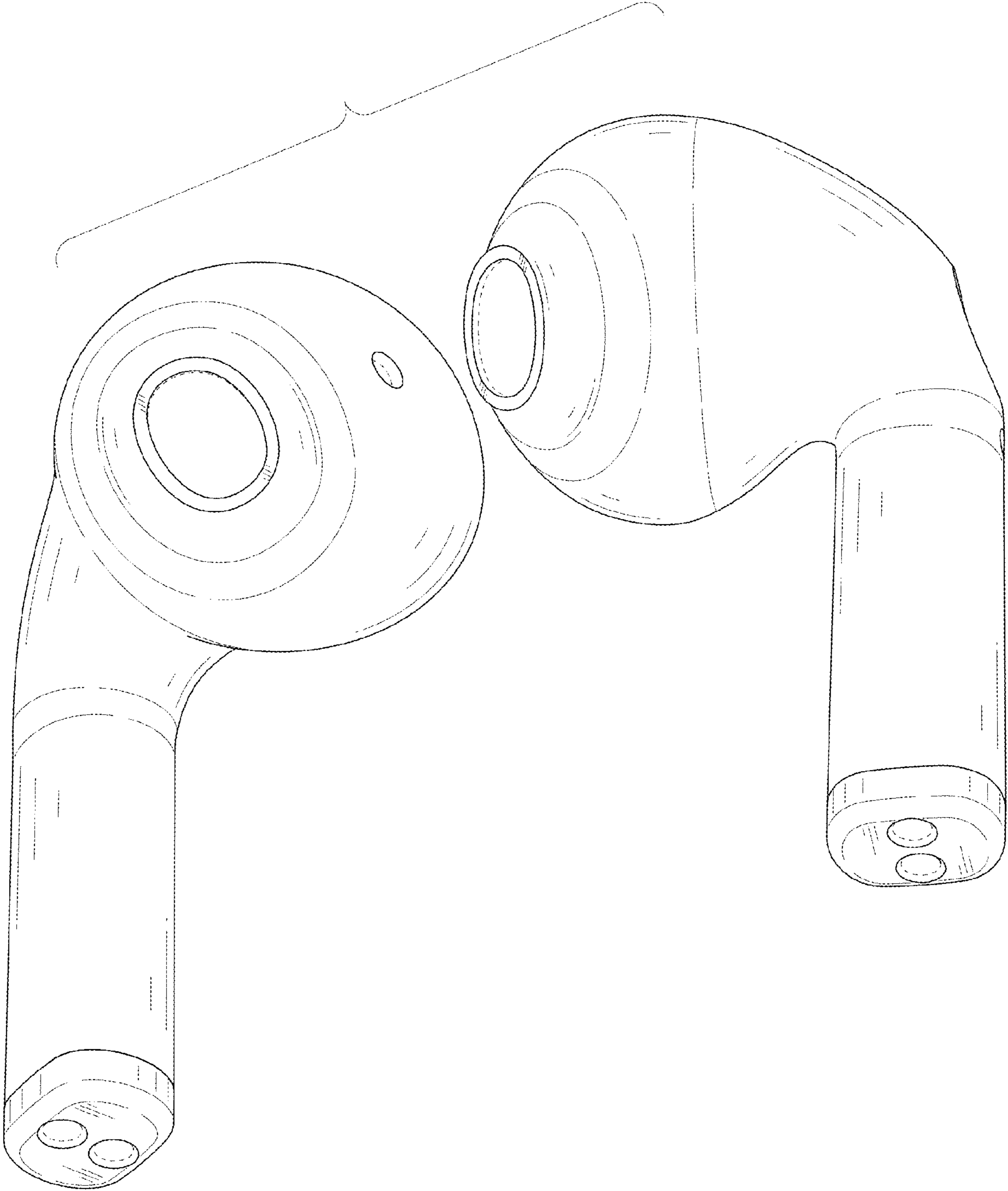

FIG. 2

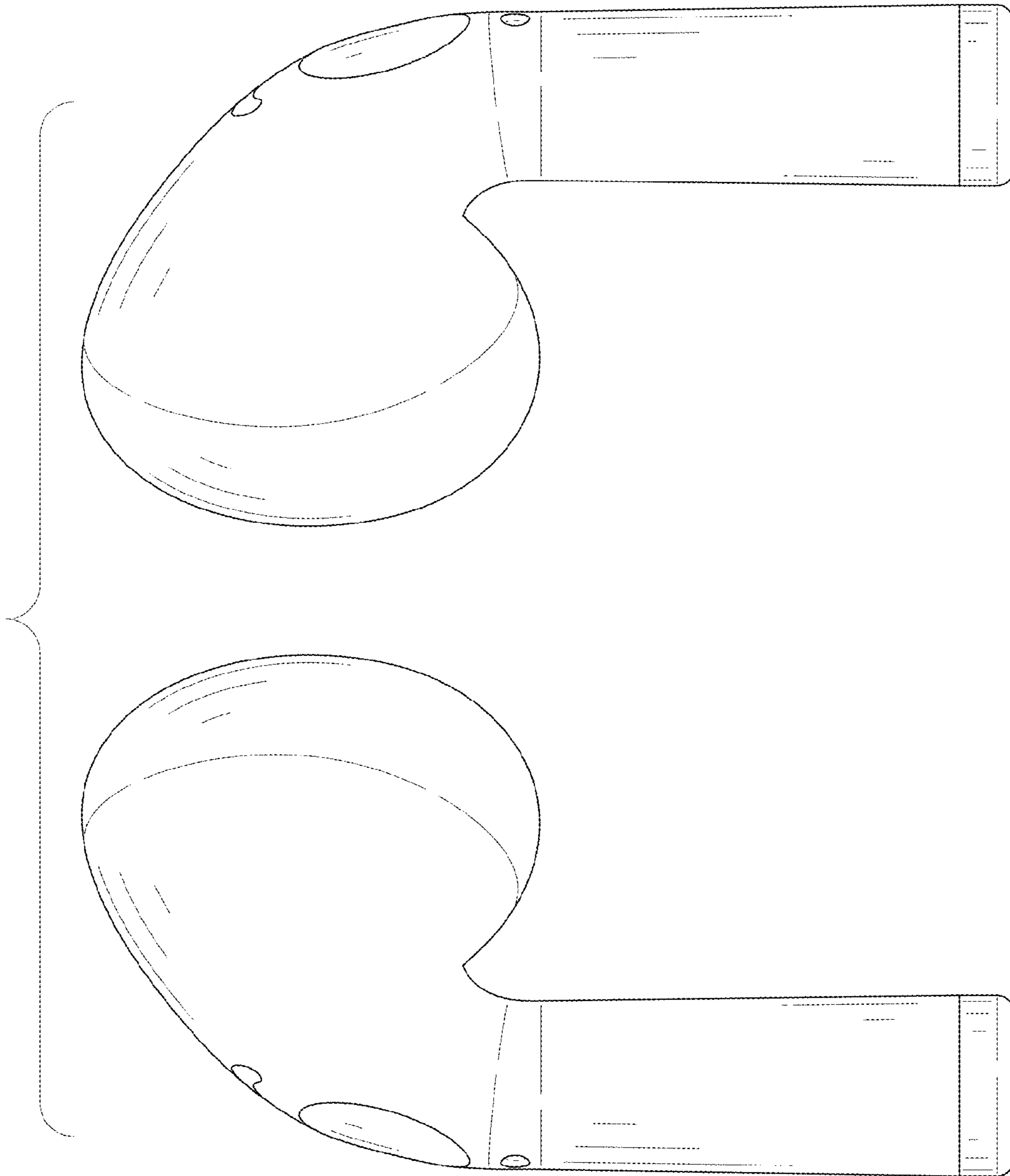

FIG. 3

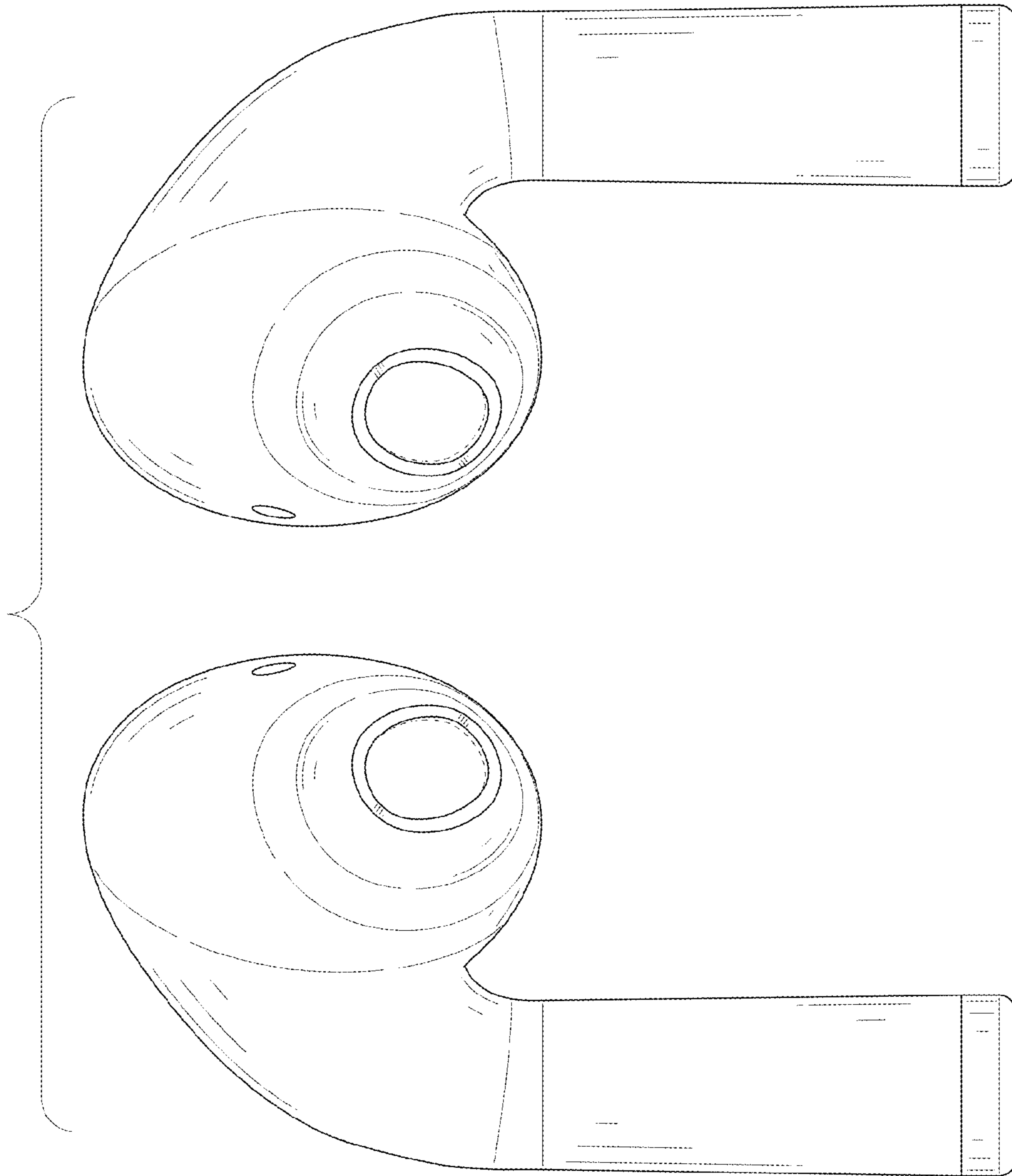

FIG. 4

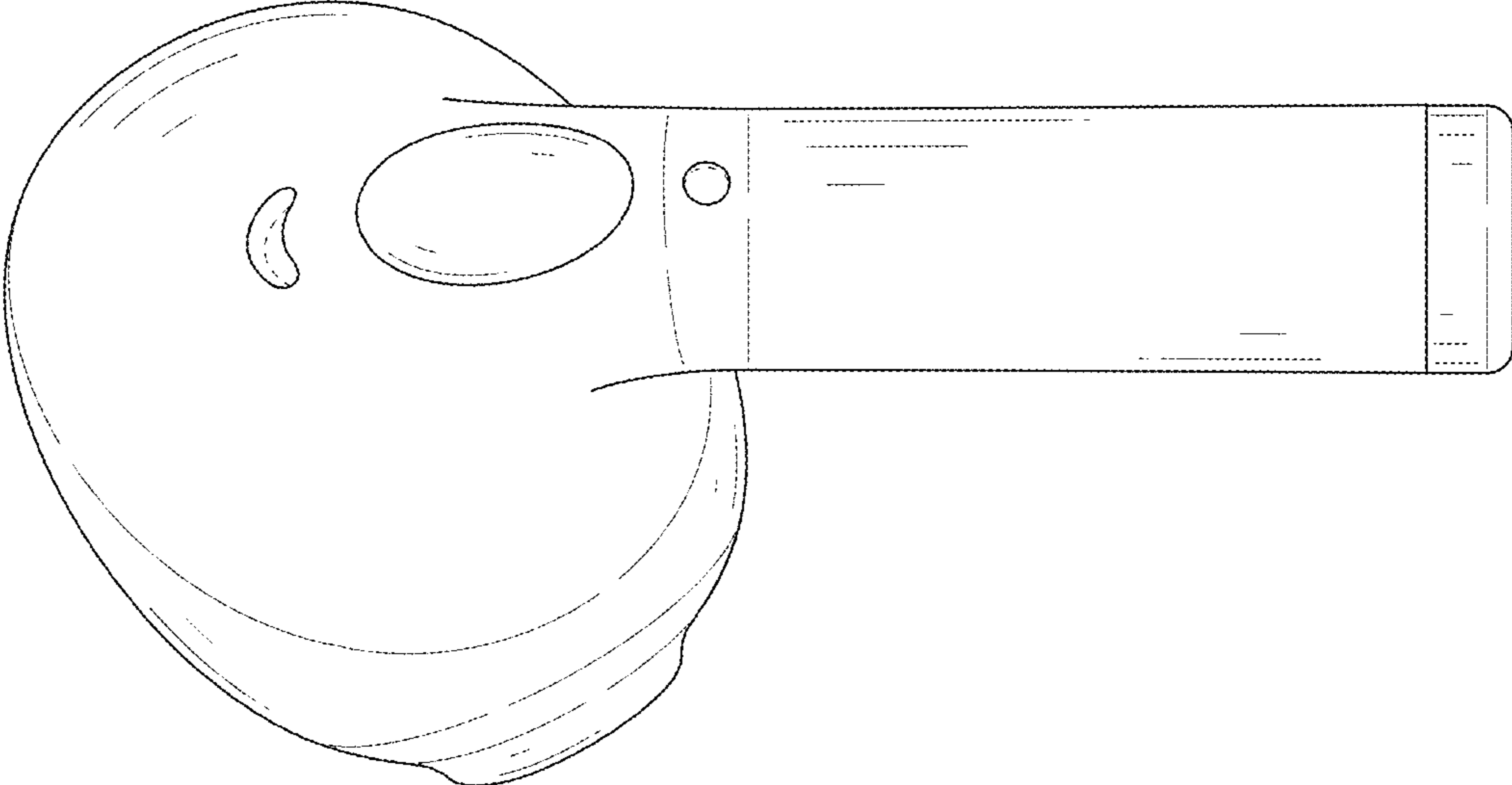

FIG. 5

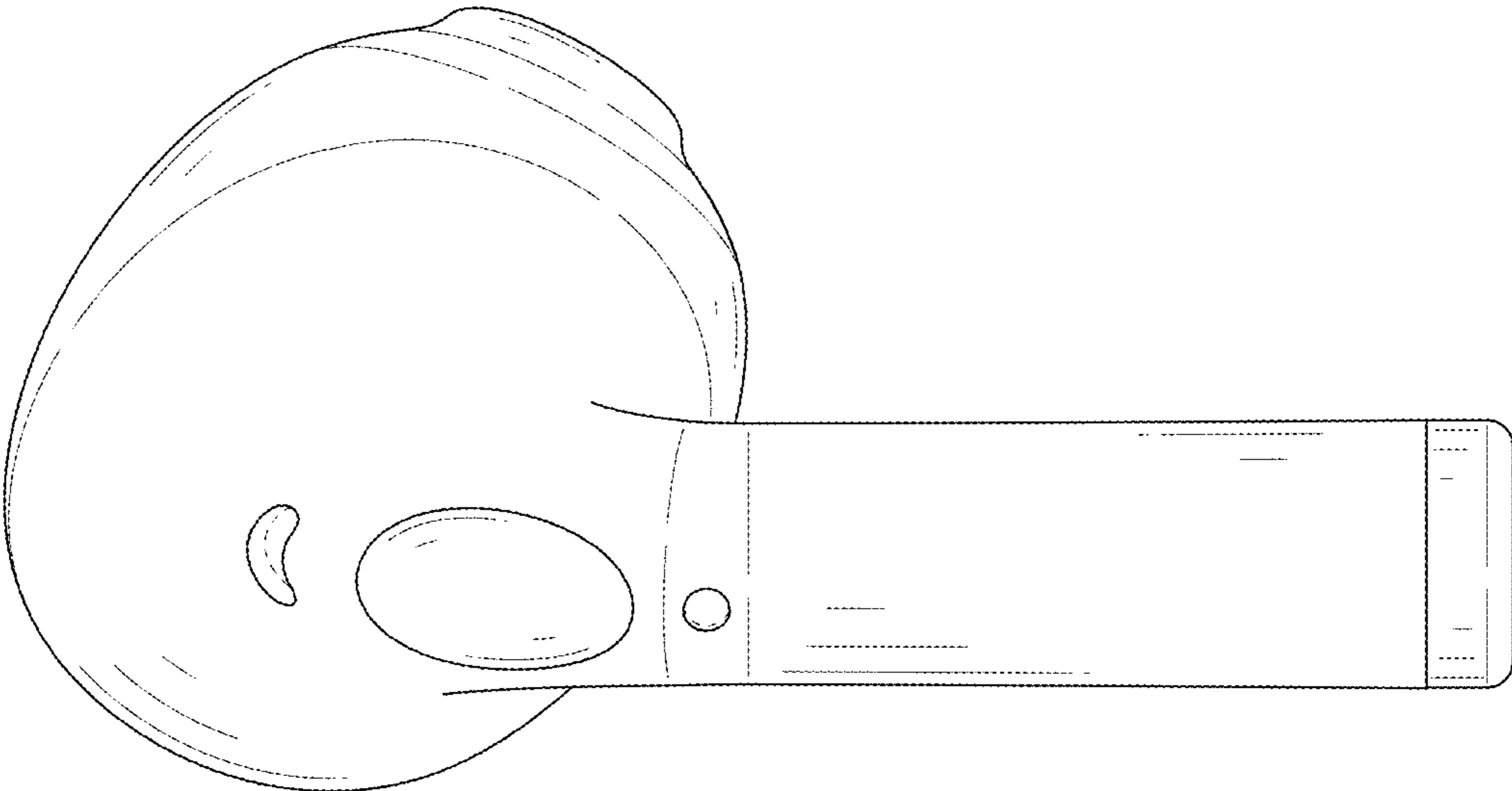

FIG. 6



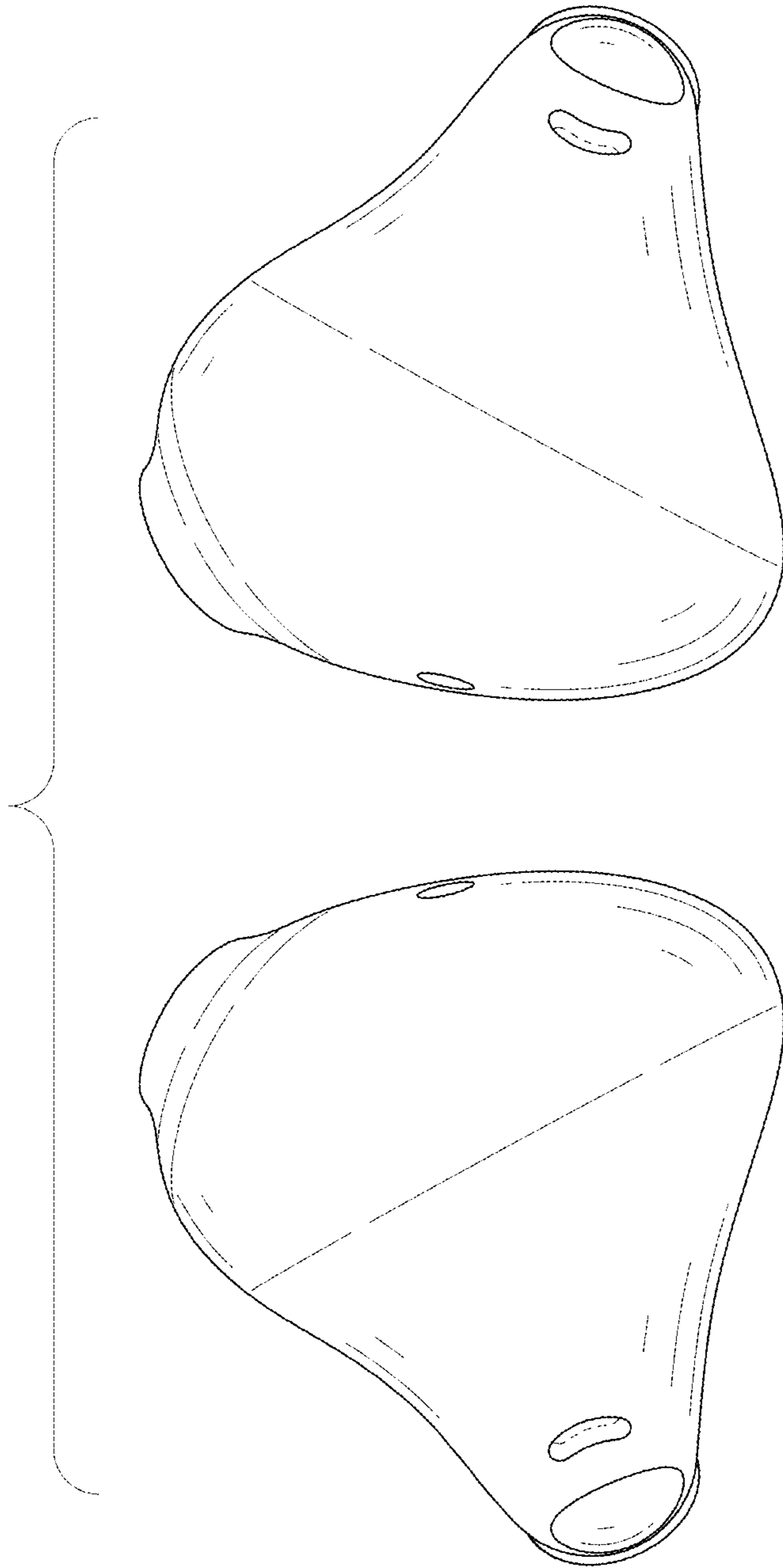

FIG. 7

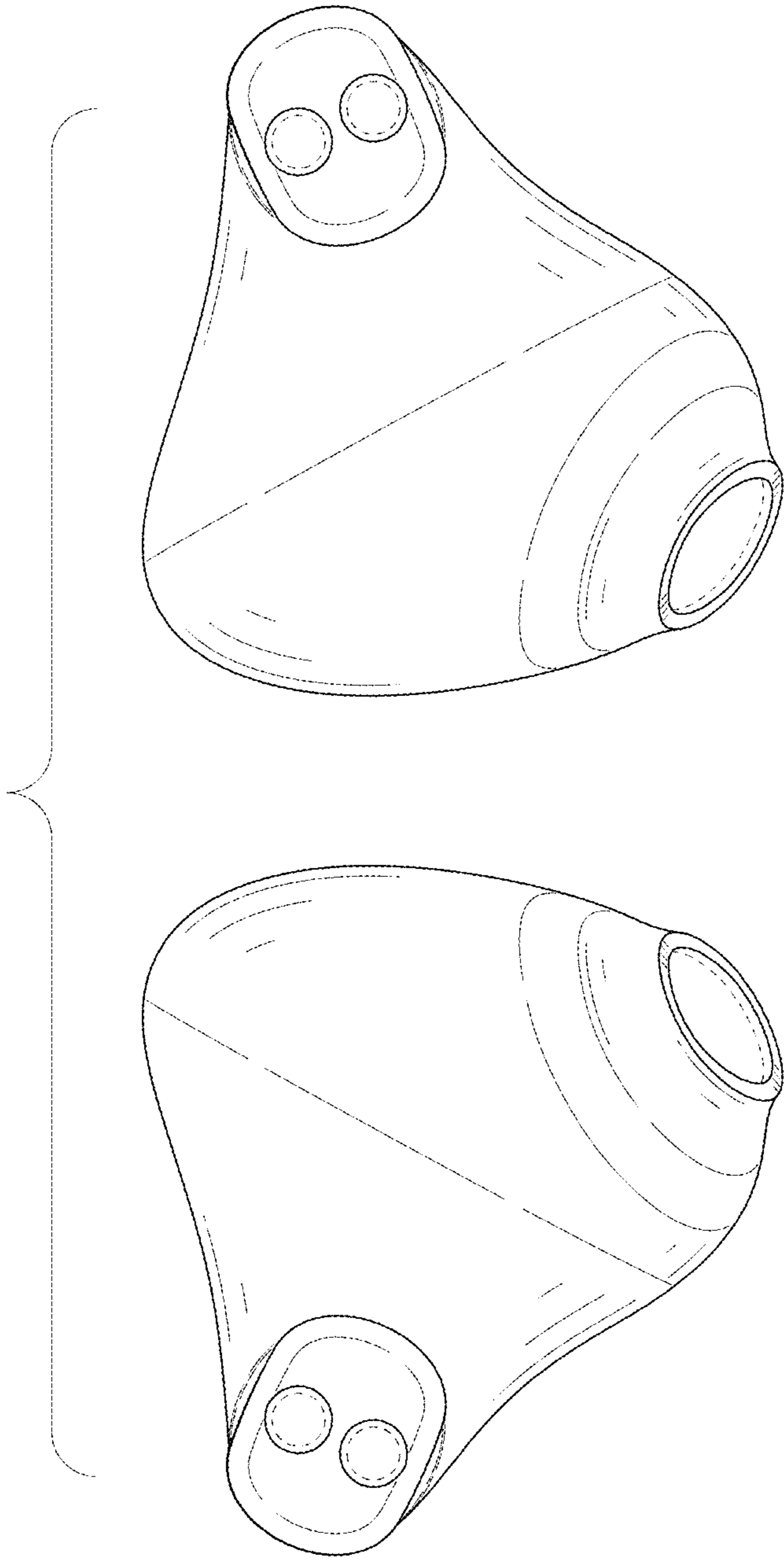

FIG. 8

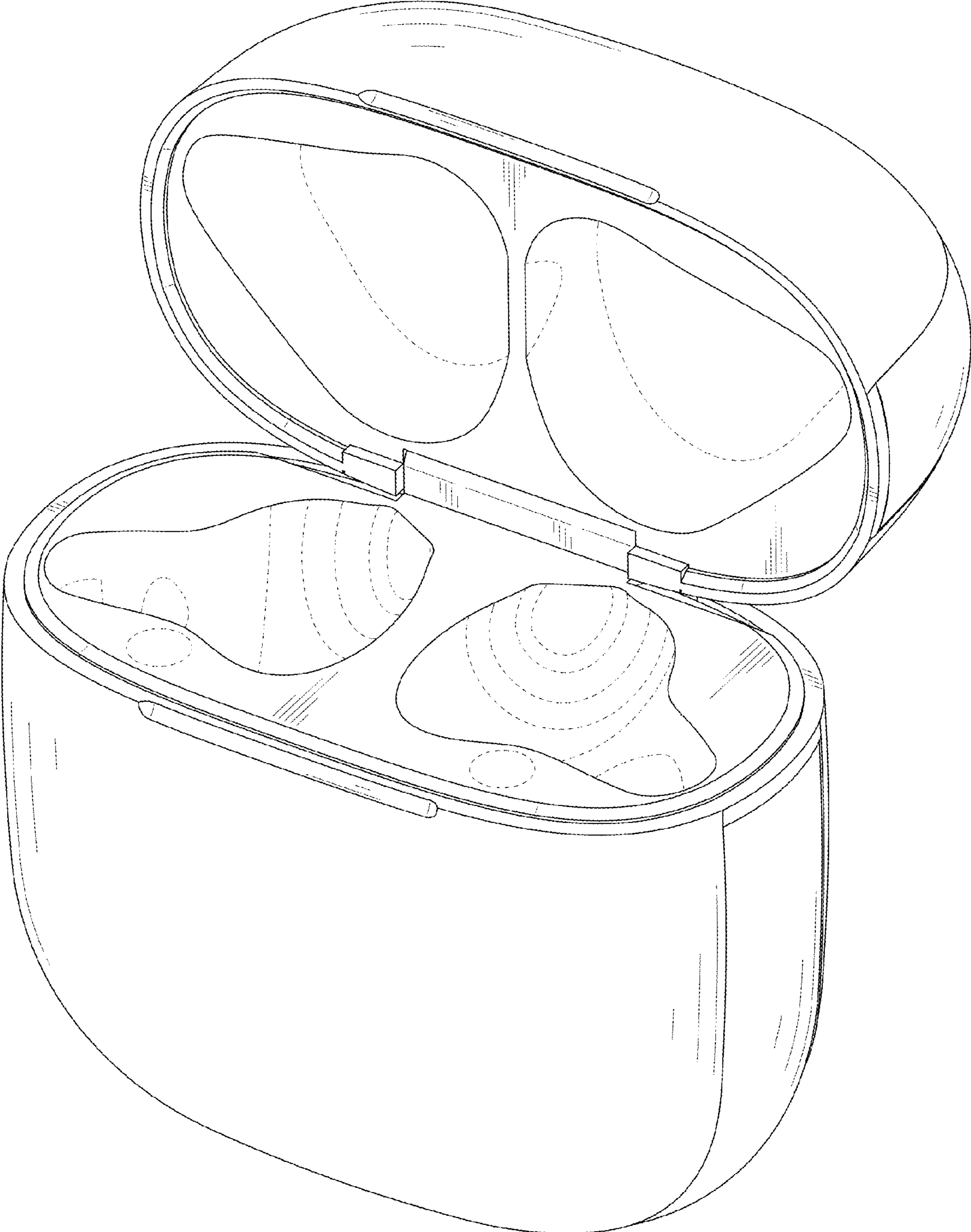

FIG. 9

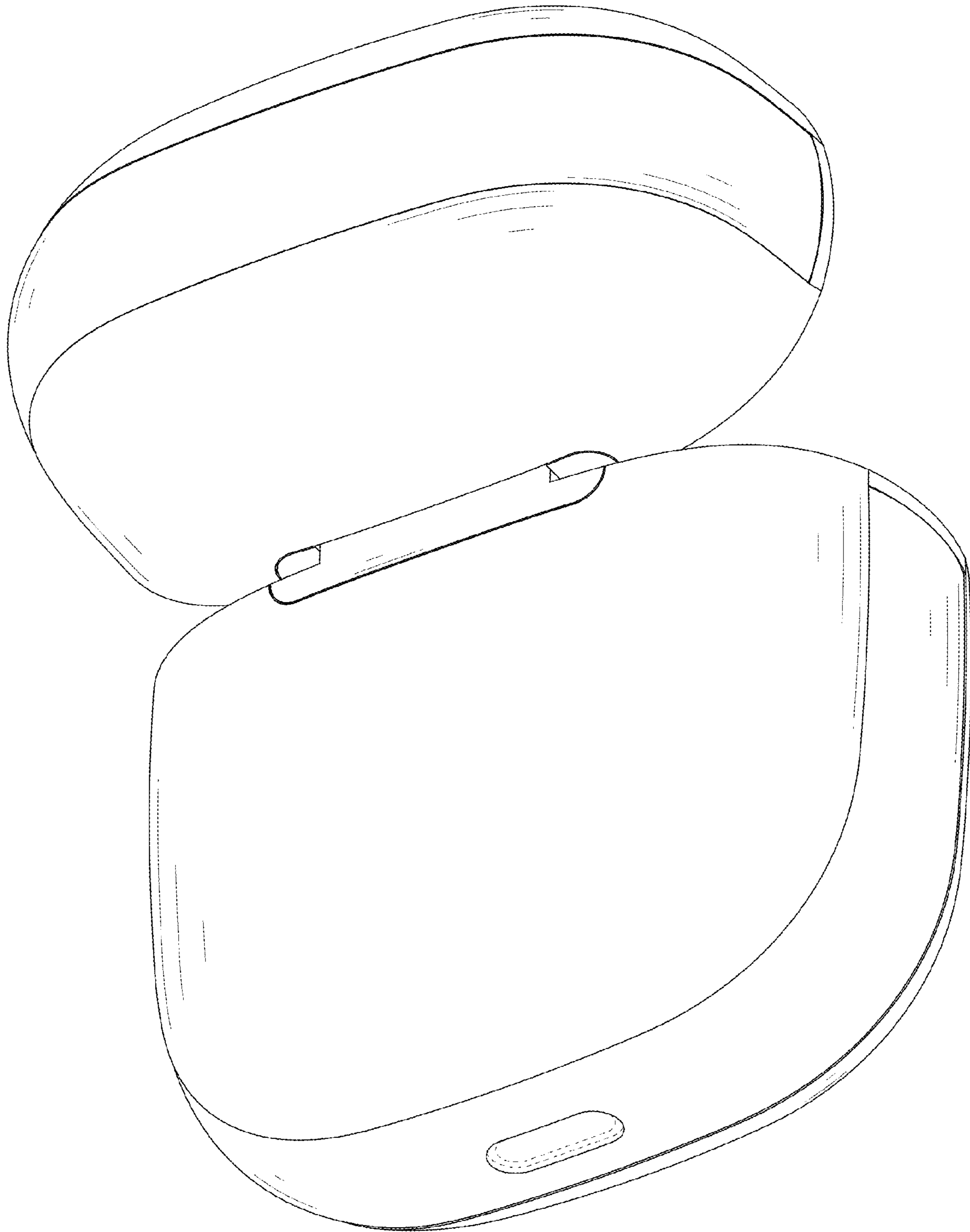

FIG. 10

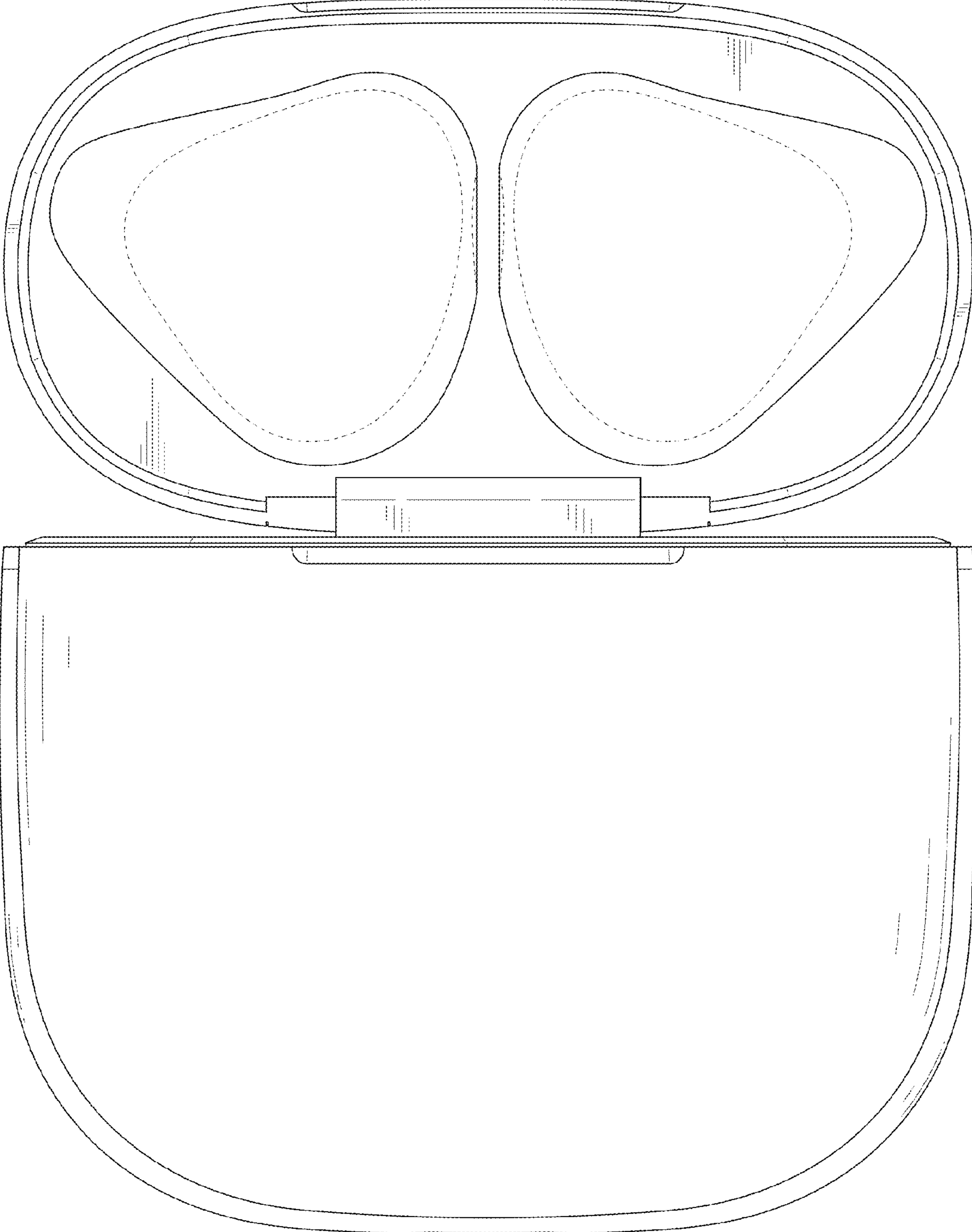

FIG. 11

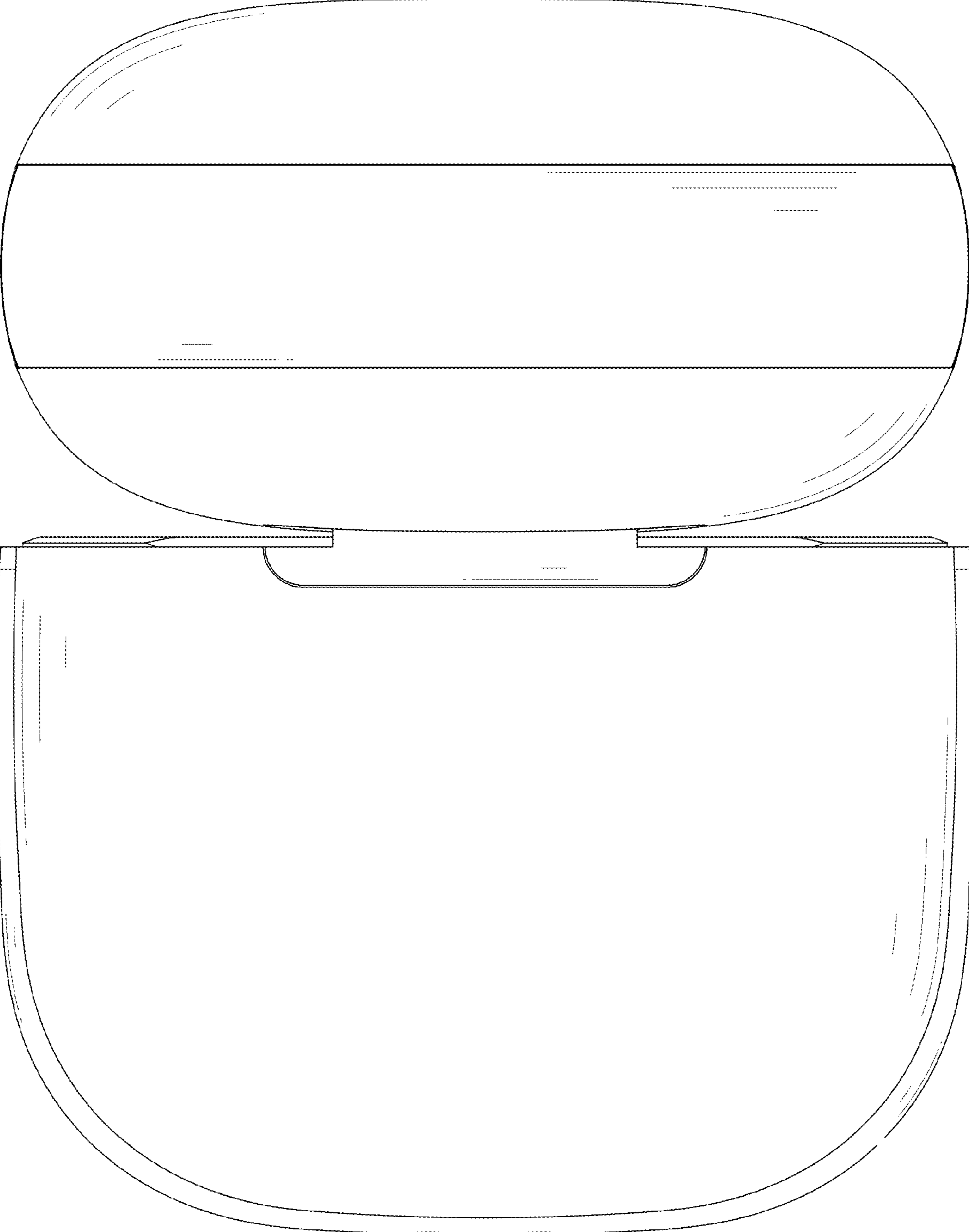

FIG. 12

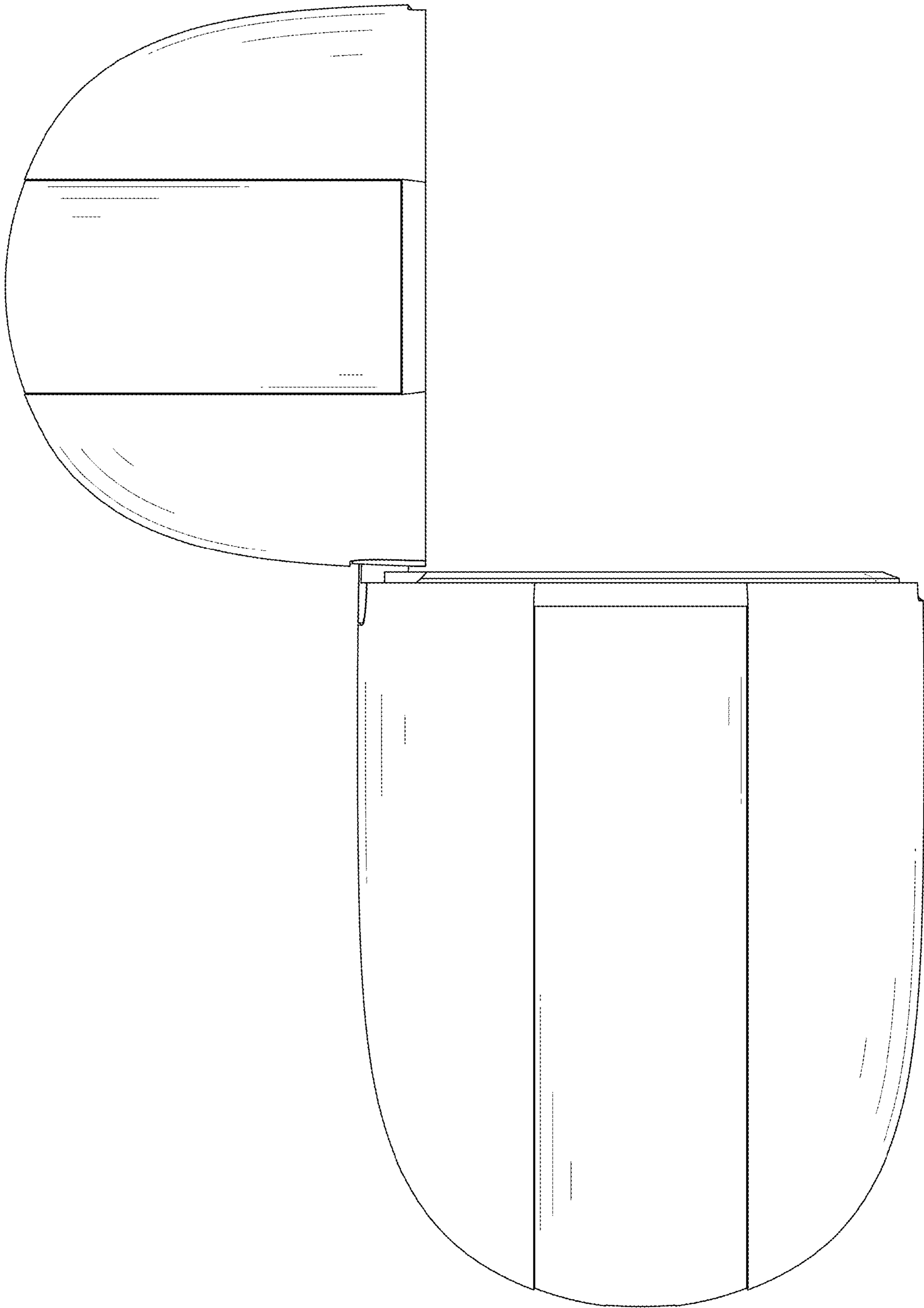

FIG. 13

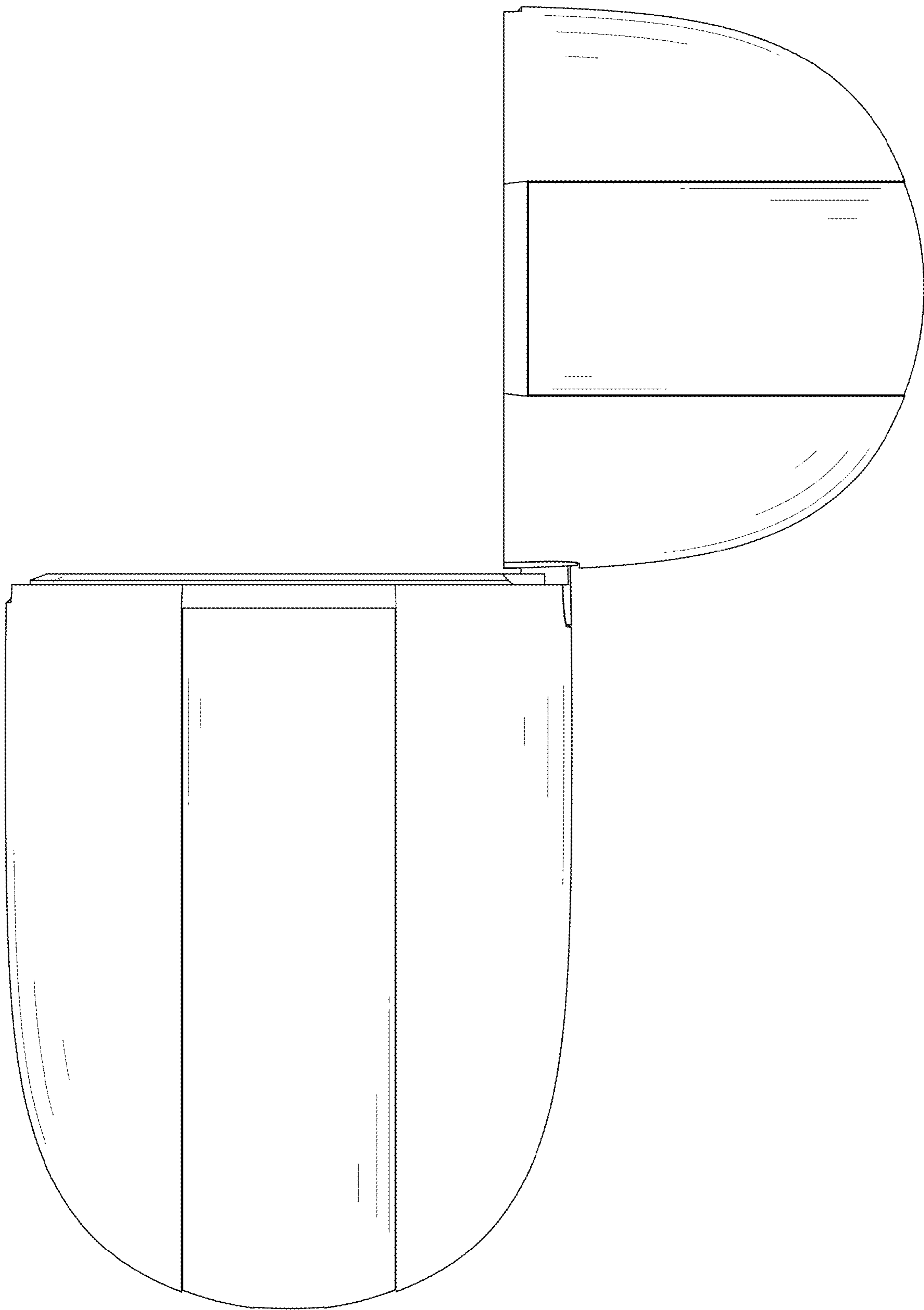

FIG. 14



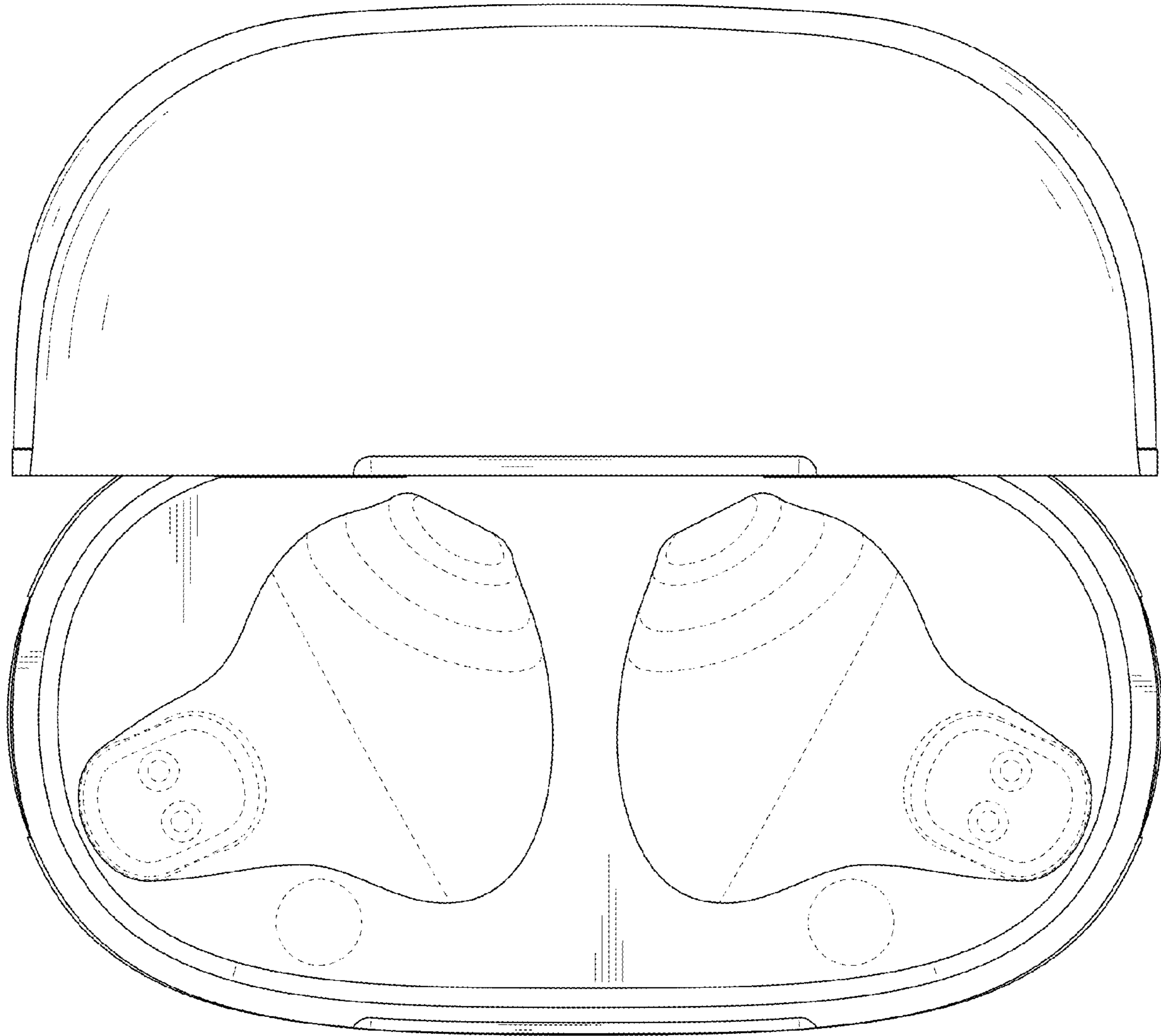

FIG. 15

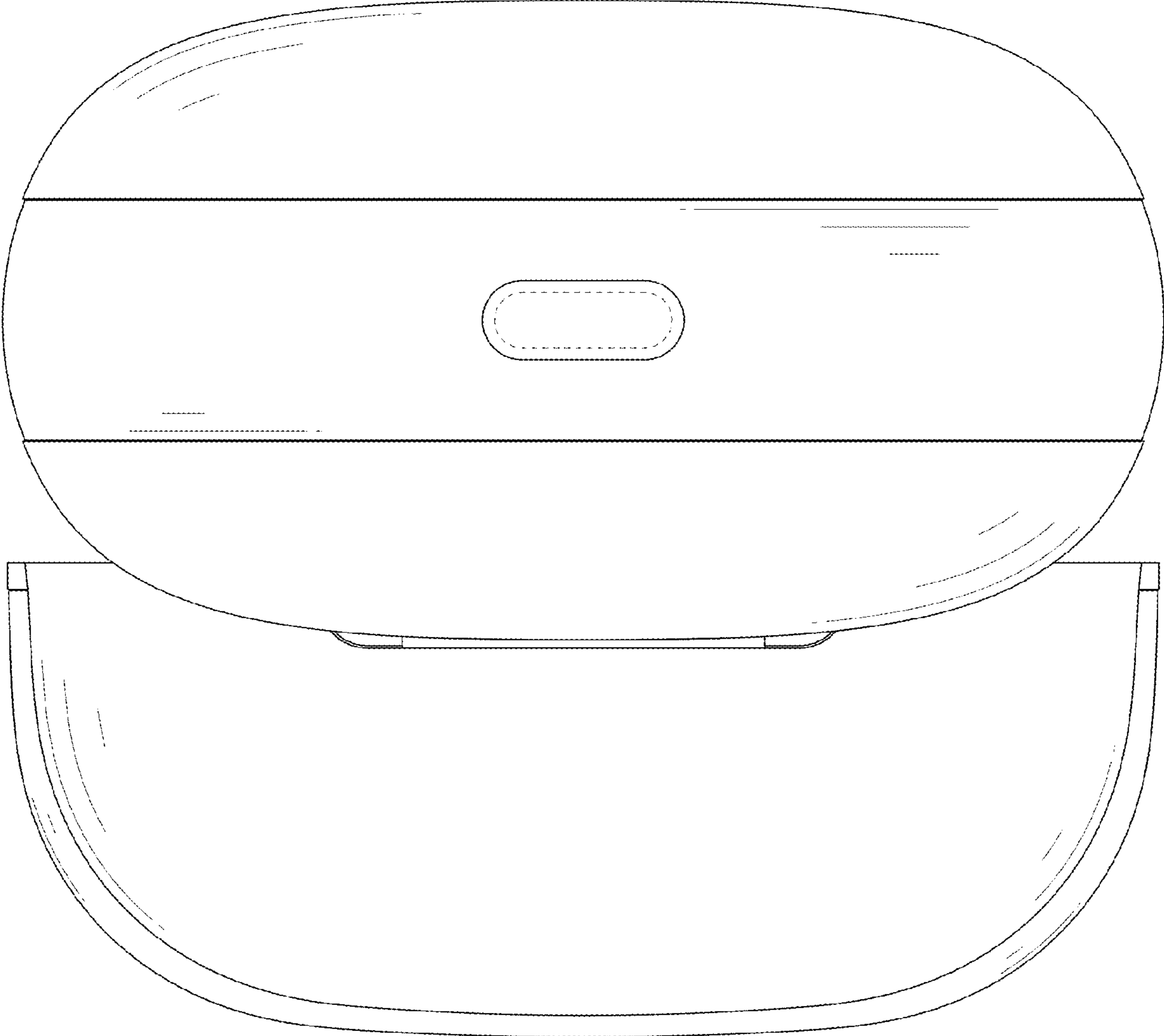

FIG. 16

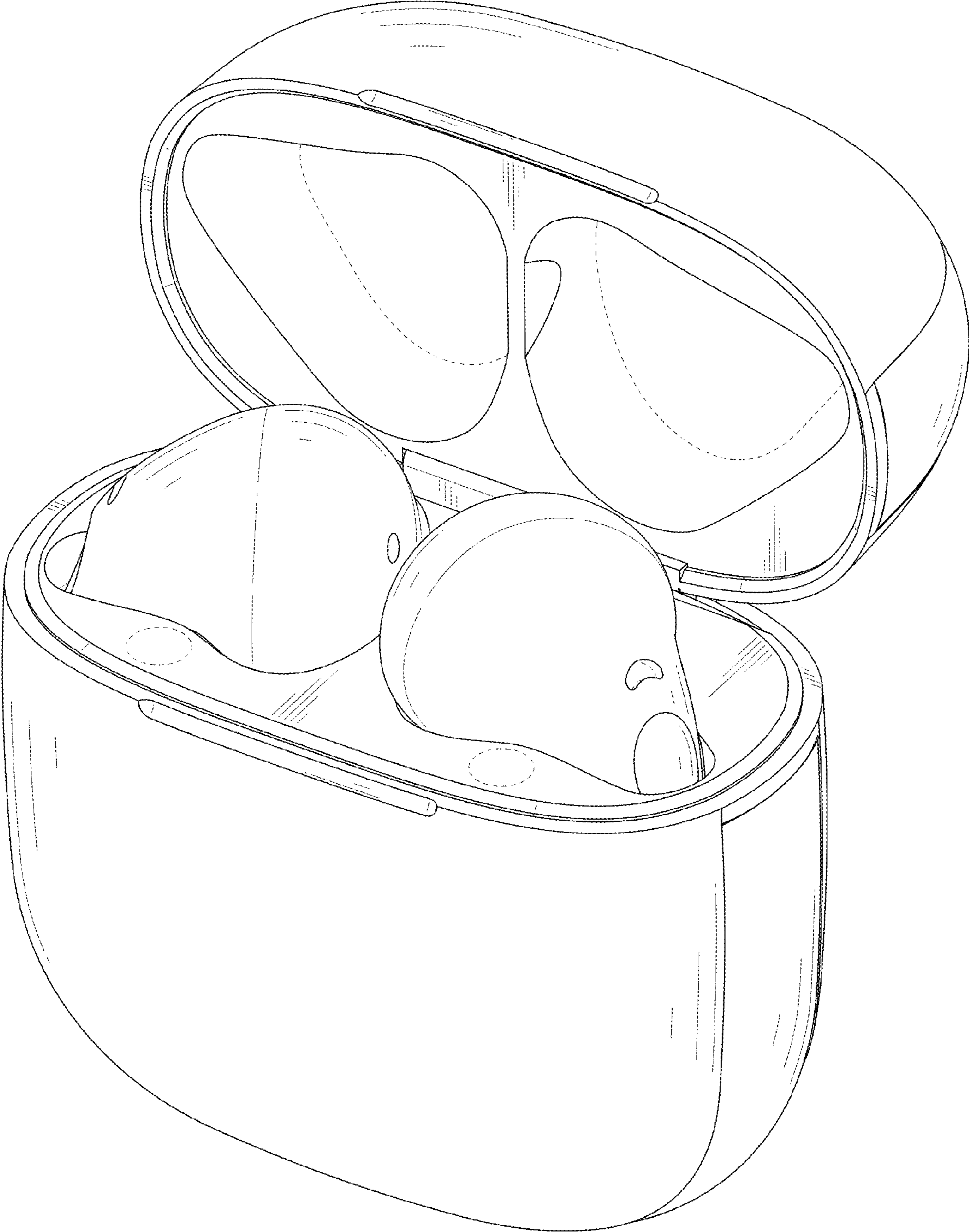

FIG. 17

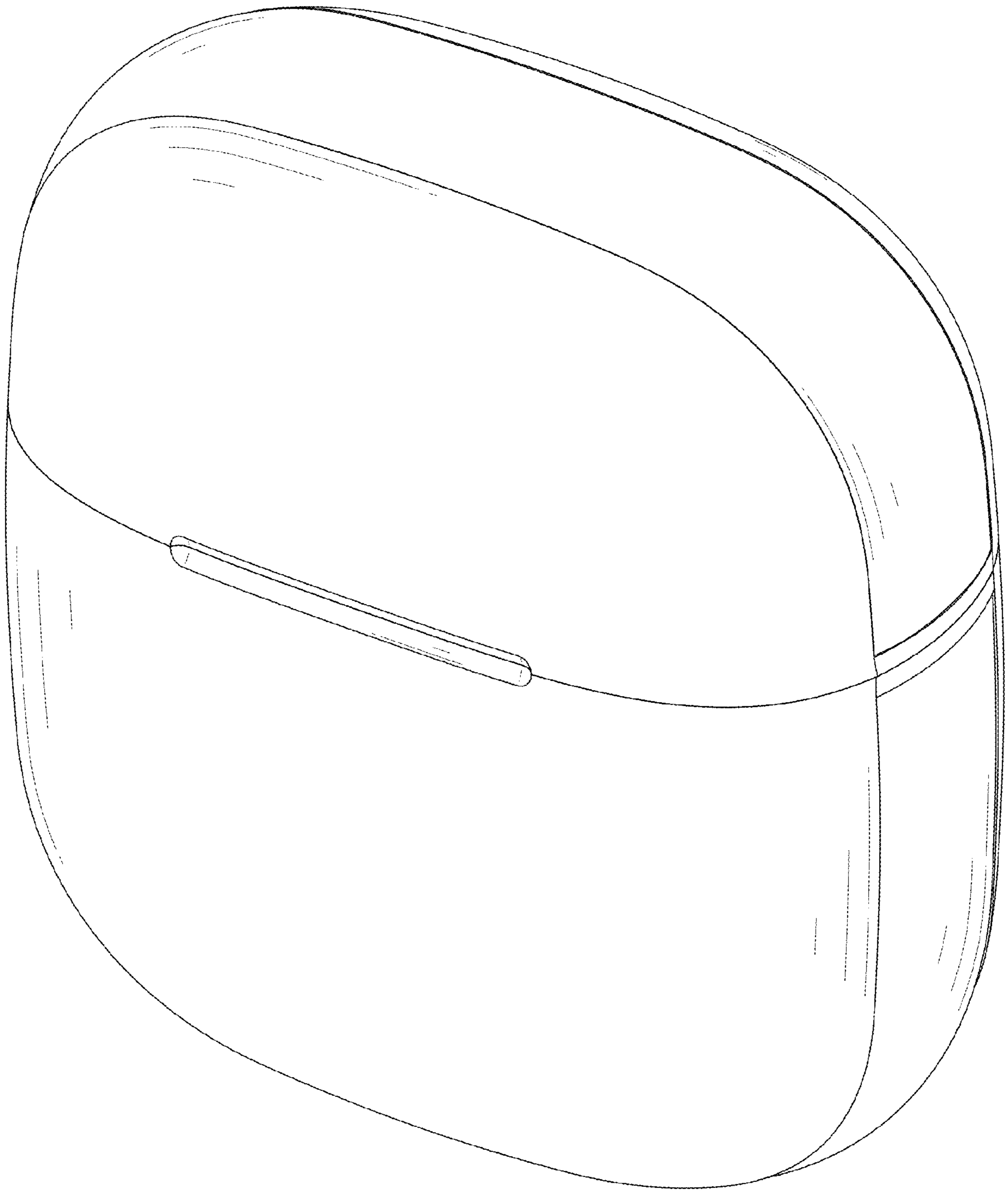

FIG. 18