



US00D932448S

(12) **United States Design Patent**
Ohashi et al.

(10) **Patent No.:** **US D932,448 S**
(45) **Date of Patent:** **** Oct. 5, 2021**

(54) **SWITCH PANEL FOR SHIPS**

- (71) Applicant: **Yanmar Co., Ltd.**, Osaka (JP)
- (72) Inventors: **Ryosuke Ohashi**, Osaka (JP); **Koichi Kanda**, Osaka (JP); **Shogo Otomo**, Osaka (JP); **Kiyoyuki Okuyama**, Yamagata (JP)
- (73) Assignee: **YANMAR POWER TECHNOLOGY CO., LTD.**, Osaka (JP)
- (**) Term: **15 Years**

(21) Appl. No.: **29/687,869**

(22) Filed: **Apr. 16, 2019**

(30) **Foreign Application Priority Data**

Oct. 18, 2018 (JP) 2018-022890

(51) **LOC (13) Cl.** **13-03**

(52) **U.S. Cl.**
USPC **D13/162**

(58) **Field of Classification Search**
USPC D13/162, 164, 169, 171, 174; D12/192, D12/317

CPC H01H 3/02; H01H 3/022; H01H 3/12; H01H 3/122; H01H 9/02; H01H 9/0235; H01H 13/023; H01H 13/04; H01H 13/06; H01H 13/063; H01H 13/10; H01H 13/12; H01H 13/142; H01H 13/20; H01H 13/30;

(Continued)

(56) **References Cited**

U.S. PATENT DOCUMENTS

- 5,385,110 A * 1/1995 Bennett B63B 39/061 114/285
- 6,085,684 A * 7/2000 Cotton B63B 39/061 114/285

(Continued)

OTHER PUBLICATIONS

Switch Panels—Carling Style—Marine Industries West; retrieved on May 26, 2021; 4pgs; <https://www.marineindustrieswest.com/SwitchPanels-CarlingStyle.htm>.*

Primary Examiner — Selina Sikder

(74) *Attorney, Agent, or Firm* — Norton Rose Fulbright US LLP

(57) **CLAIM**

The ornamental design for a switch panel for ships, as shown and described.

DESCRIPTION

FIG. 1 is a front elevational view of a first embodiment of a switch panel for ships according to our new design; FIG. 2 is a rear elevational view of the first embodiment; FIG. 3 is a left side elevational view of the first embodiment; FIG. 4 is a right side elevational view of the first embodiment; FIG. 5 is a top plan view of the first embodiment; FIG. 6 is a bottom plan of the first embodiment; FIG. 7 is a perspective view of the switch panel for ships taken from the front, top and left side of the first embodiment; FIG. 8 is a front elevational view of a second embodiment of the switch panel for ships according to our new design; FIG. 9 is a rear elevational view of the second embodiment; FIG. 10 is a left side elevational view of the second embodiment; FIG. 11 is a right side elevational view of the second embodiment; FIG. 12 is a top plan view of the second embodiment; and, FIG. 13 is a bottom plan of the second embodiment. The broken lines are for purpose of illustrating portions of the article that form no part of the claim.

1 Claim, 7 Drawing Sheets

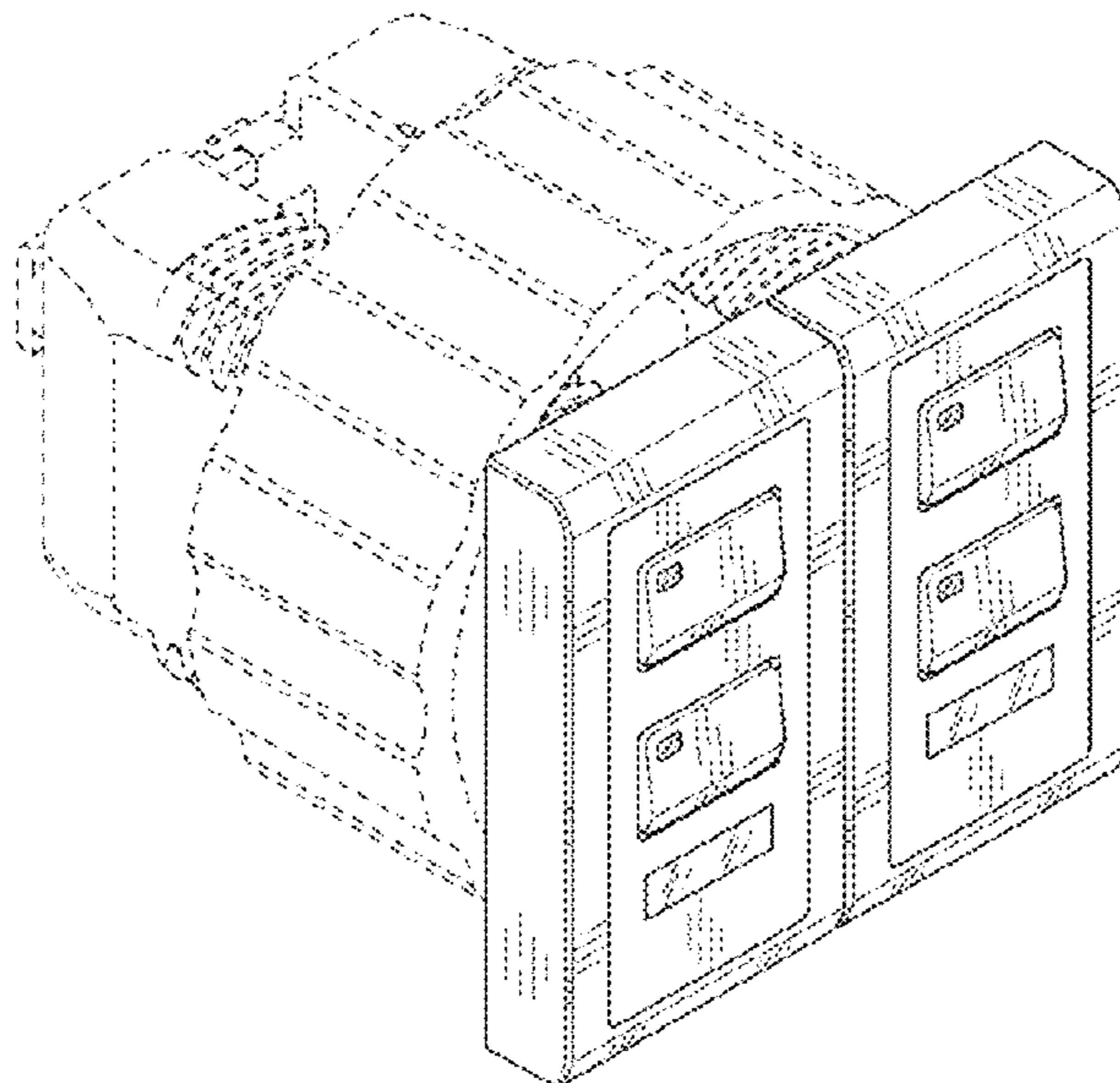

(58) **Field of Classification Search**

CPC H01H 13/36; H01H 13/70; H01H 13/86;
 H01H 21/24; H01H 25/065; H01H 23/02;
 H01H 23/025; H01H 23/04; H01H 23/08;
 H01H 23/145; H04B 1/08; H04B 1/082;
 G05B 19/409; G05B 2219/23406; H05K
 5/00; H05K 5/0017; H05K 5/02; H05K
 5/0217; H05K 5/03; B63B 39/061; B63H
 20/08; B63H 20/10

See application file for complete search history.

(56) **References Cited**

U.S. PATENT DOCUMENTS

D441,723	S *	5/2001	Mayo	D13/162
D541,221	S *	4/2007	Spira	D13/162
7,318,389	B2 *	1/2008	Boning	B63B 39/061
					114/285
D563,326	S *	3/2008	Patel	D13/164
D576,564	S *	9/2008	Hewson	D13/162
D588,074	S *	3/2009	Hollner	D13/164
D596,140	S *	7/2009	Hollner	D13/164
D712,361	S *	9/2014	Rodriguez	D13/164
D721,044	S *	1/2015	Rodriguez	D13/164
D804,431	S *	12/2017	Abellera	D13/162
D852,761	S *	7/2019	Hoffknecht	D13/164
D882,530	S *	4/2020	Plaja Miro	D13/169
2019/0115731	A1 *	4/2019	Wisniewski	H01H 13/86
2021/0153330	A1 *	5/2021	Vansickel	G05B 15/02

* cited by examiner

FIG. 1

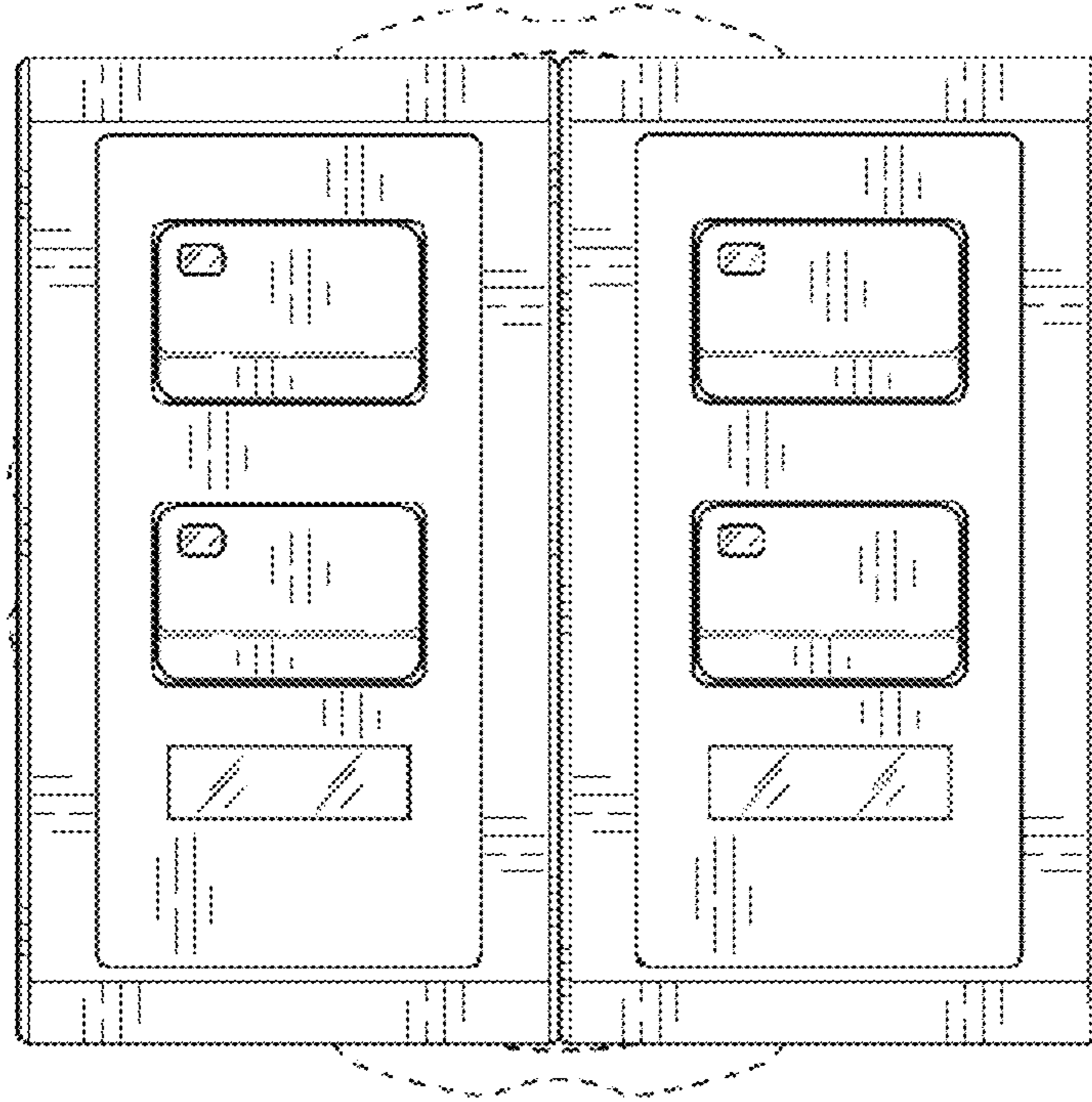

FIG. 2

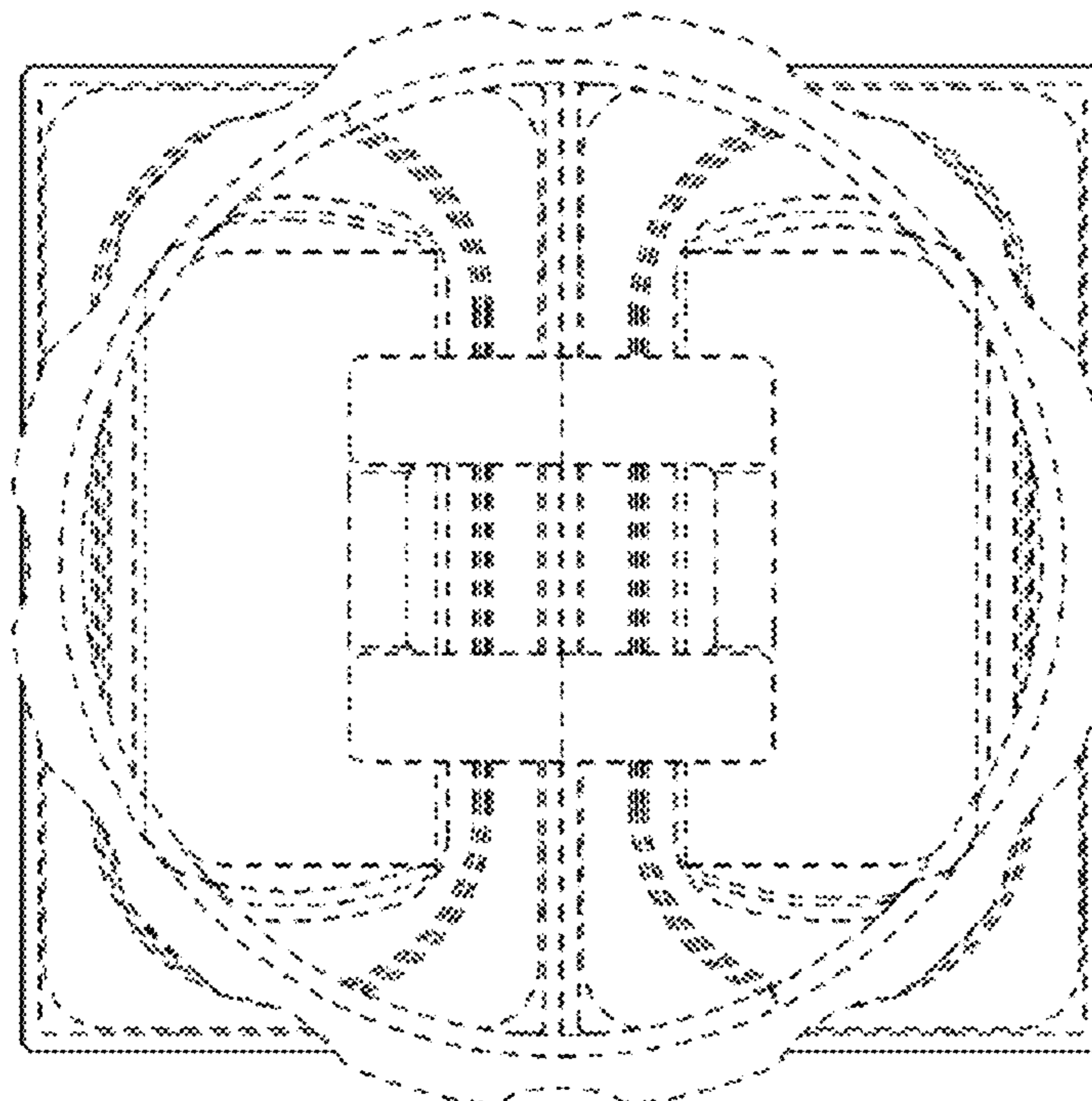

FIG. 3

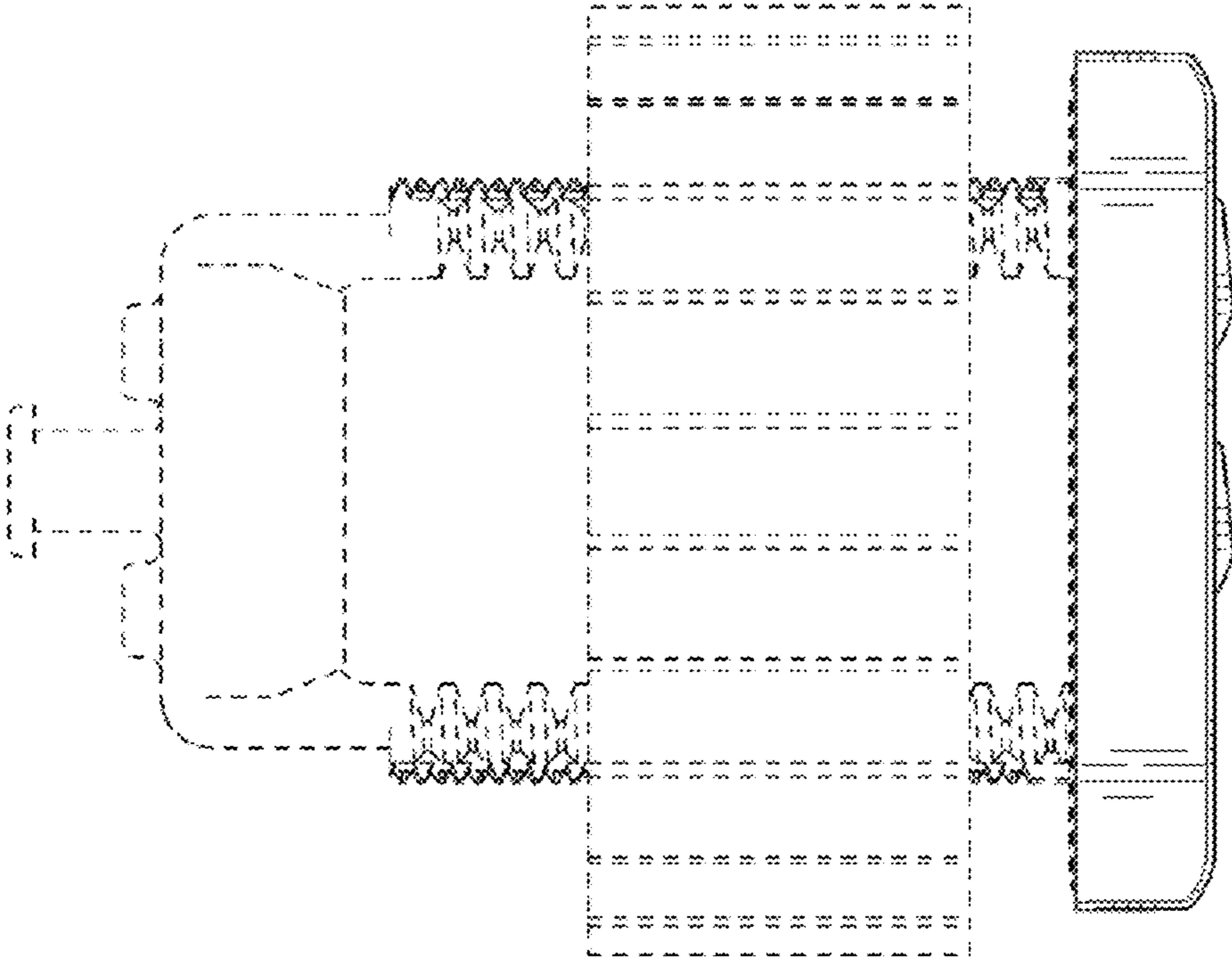

FIG. 4

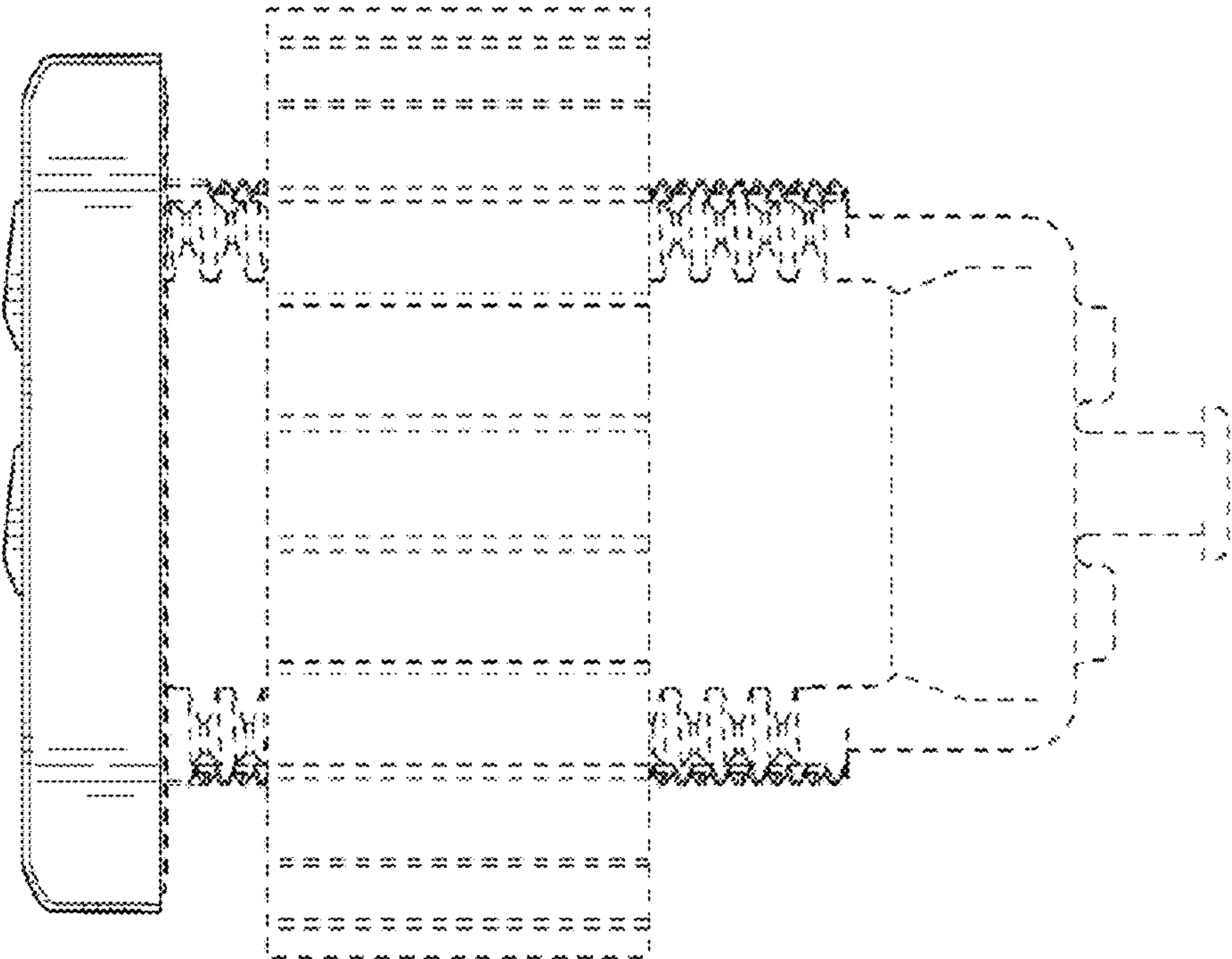

FIG. 5

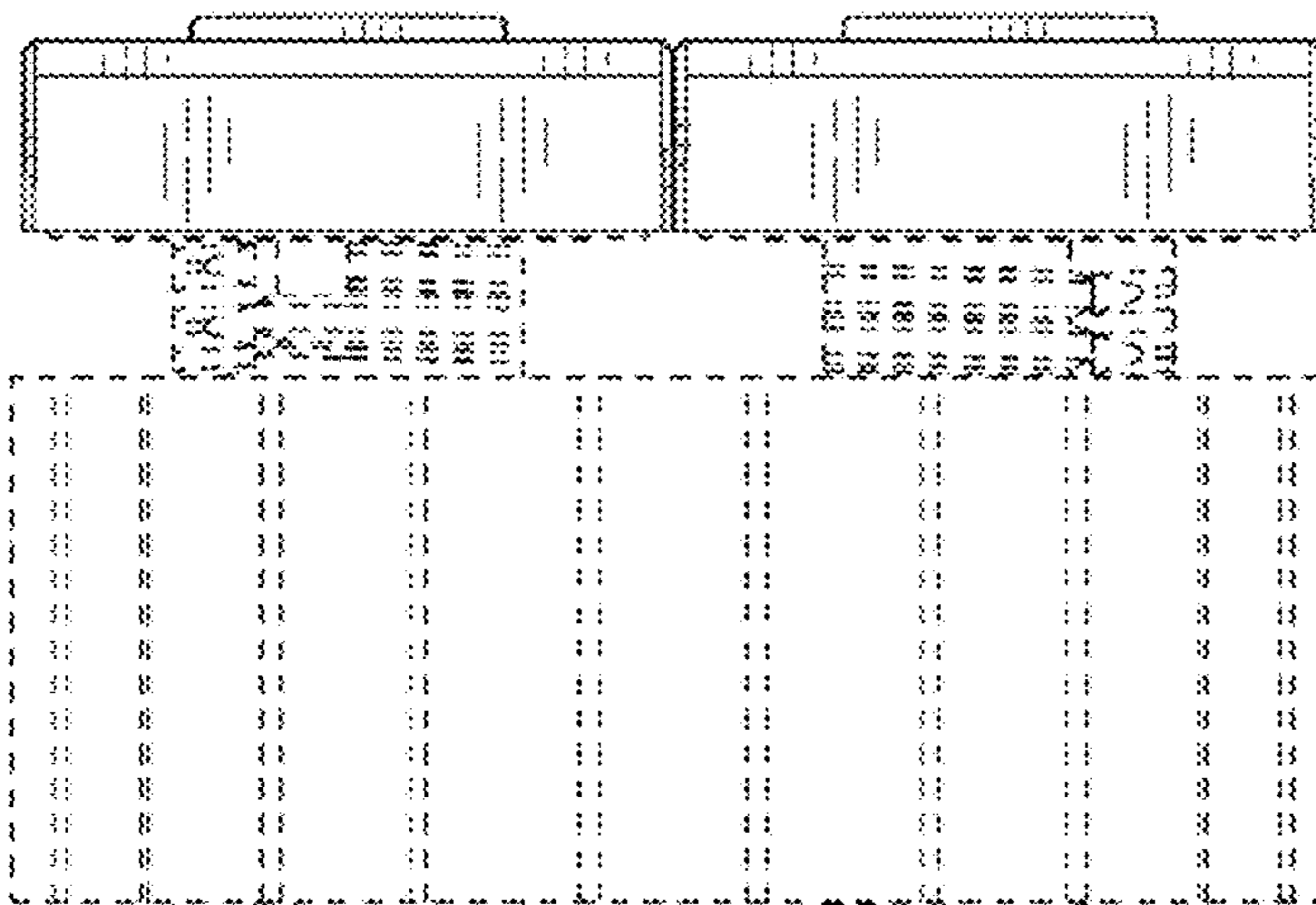
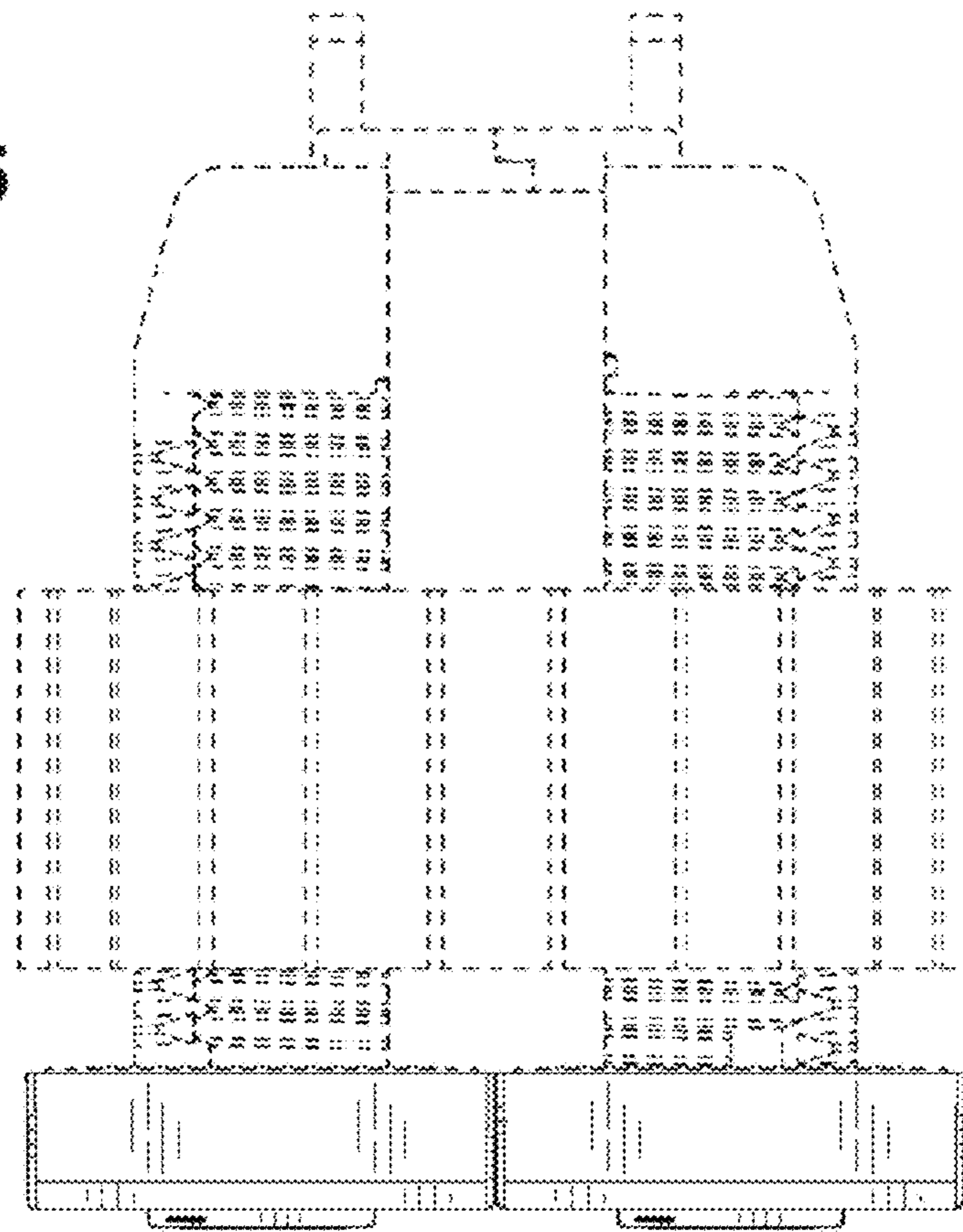

FIG. 6

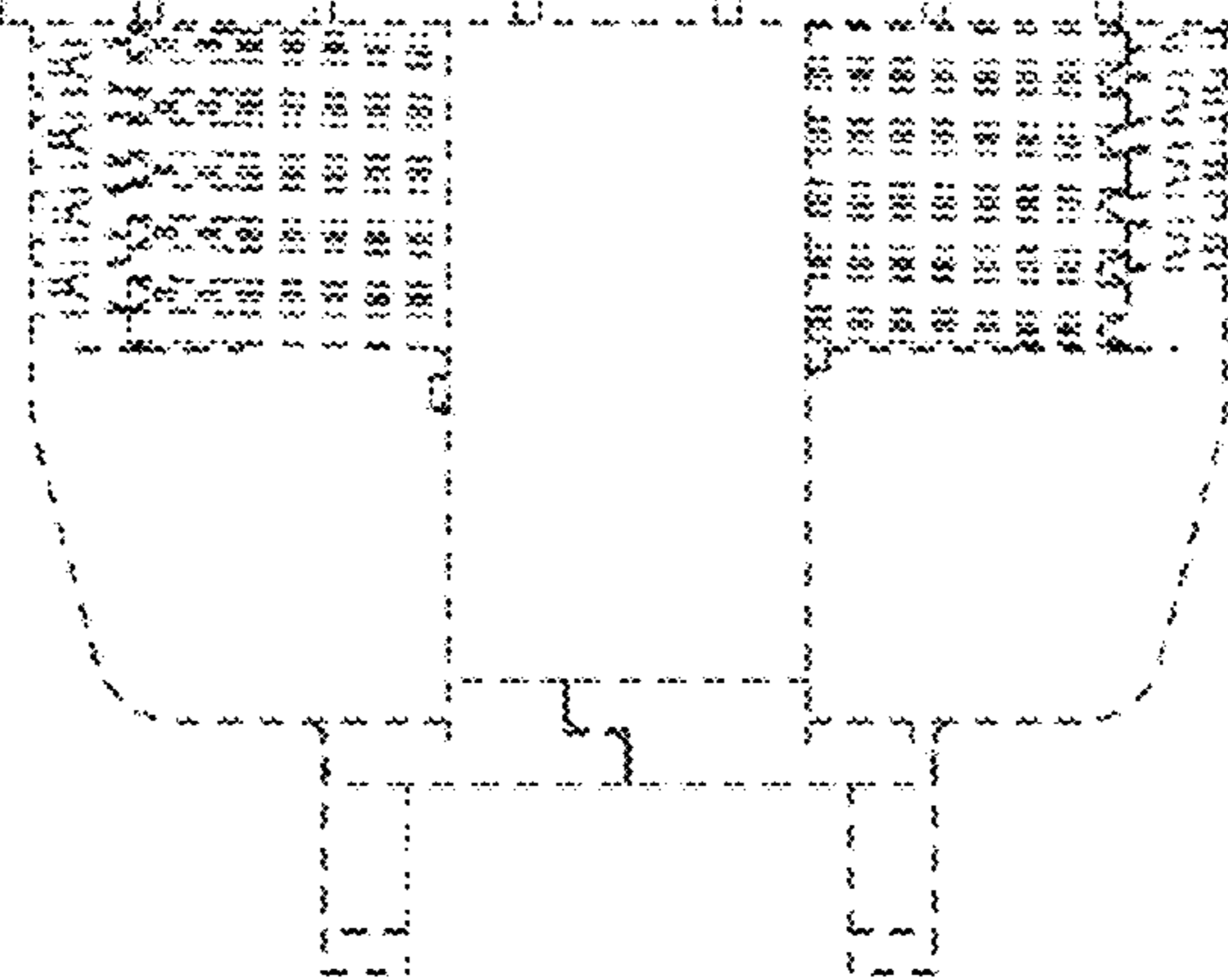

FIG. 7

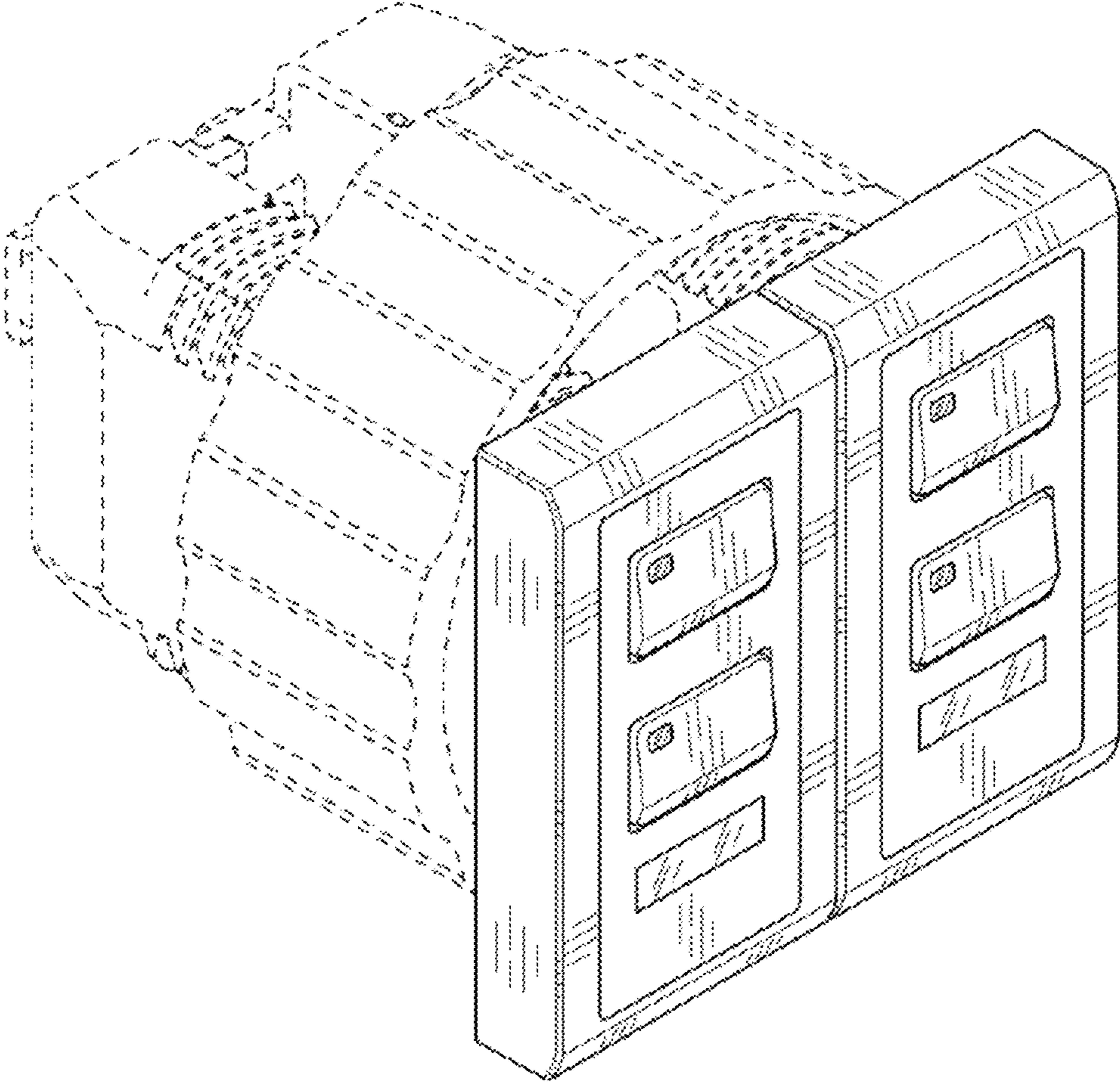

FIG. 8

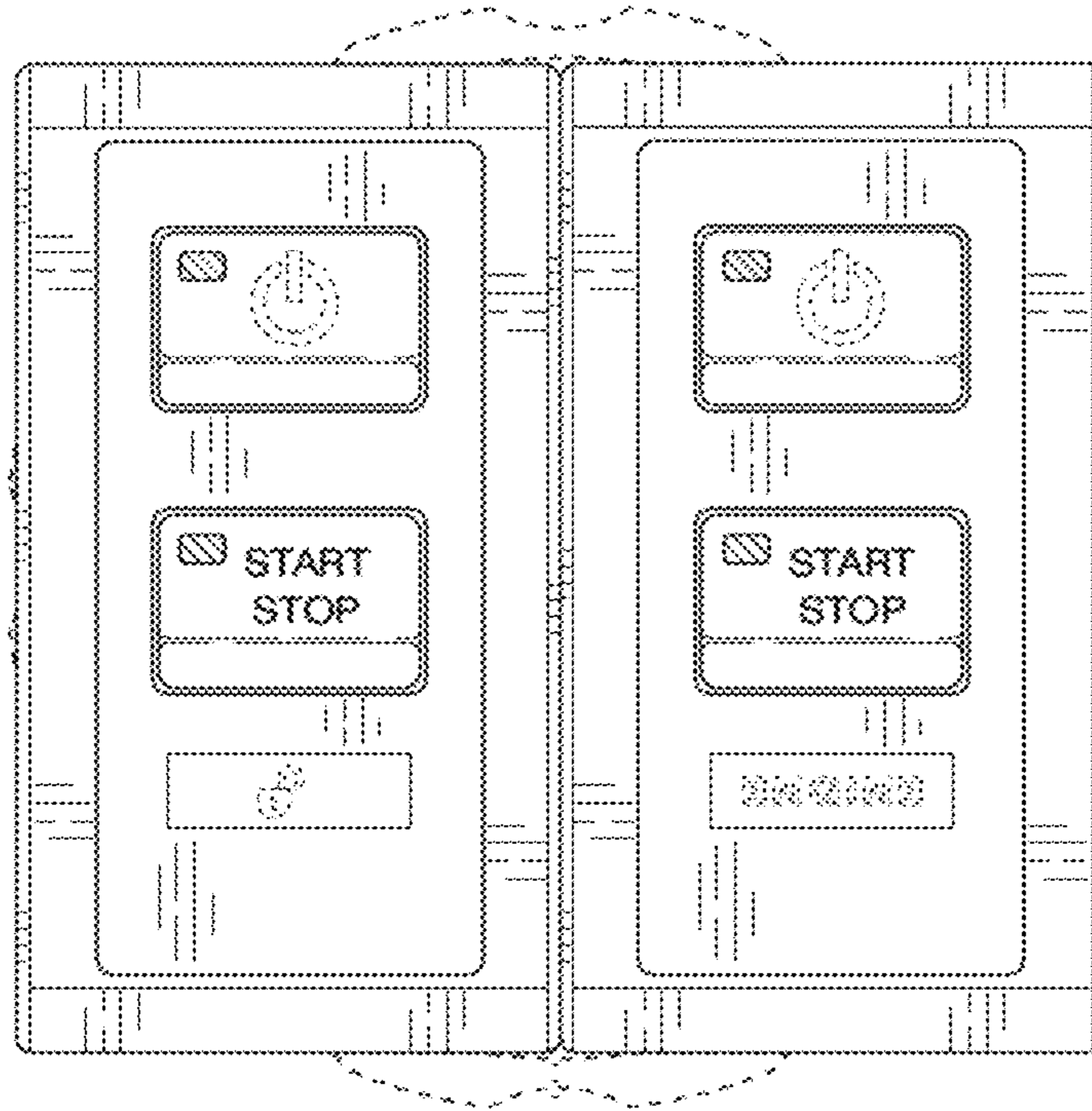

FIG. 9

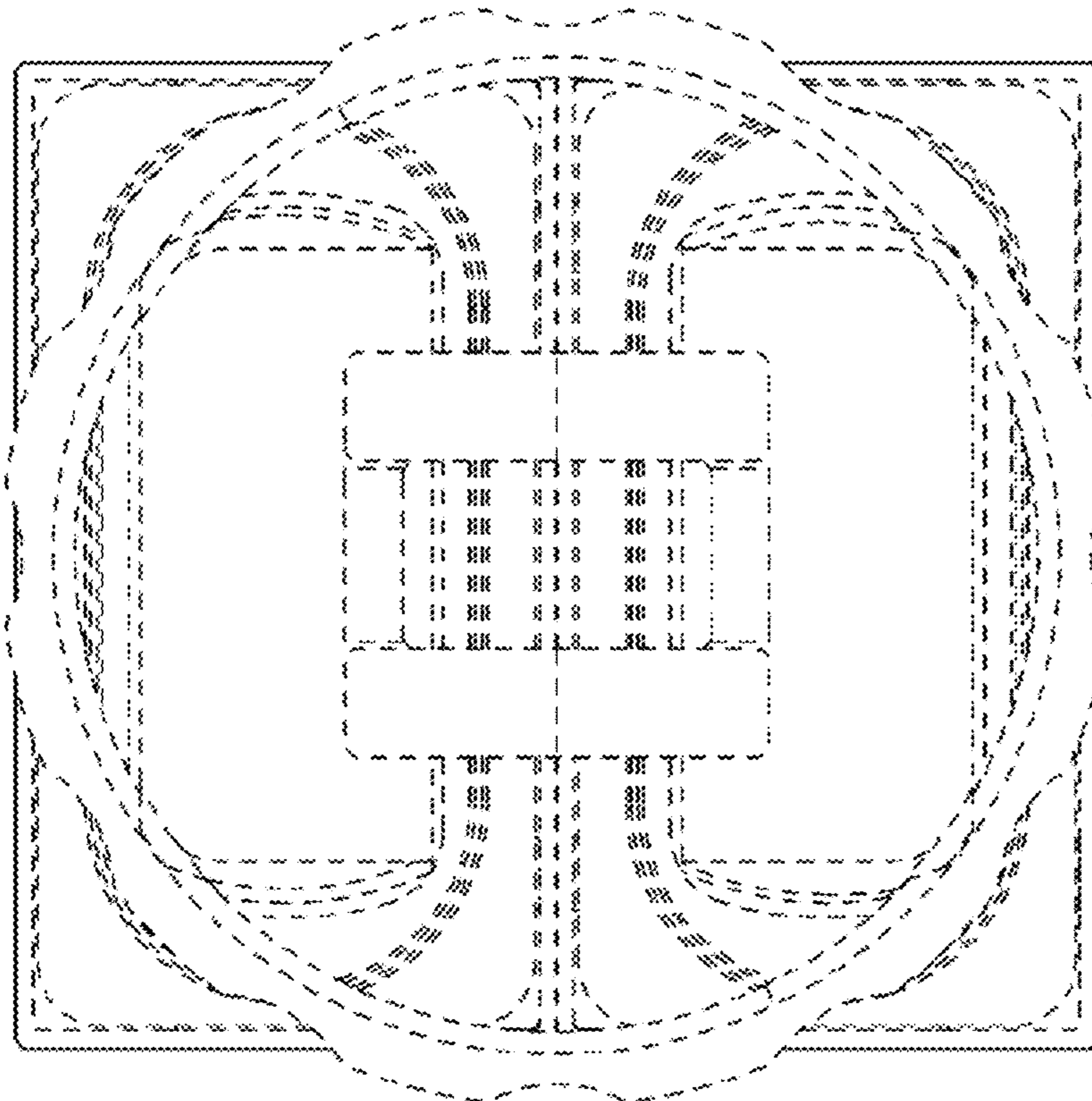

FIG. 10

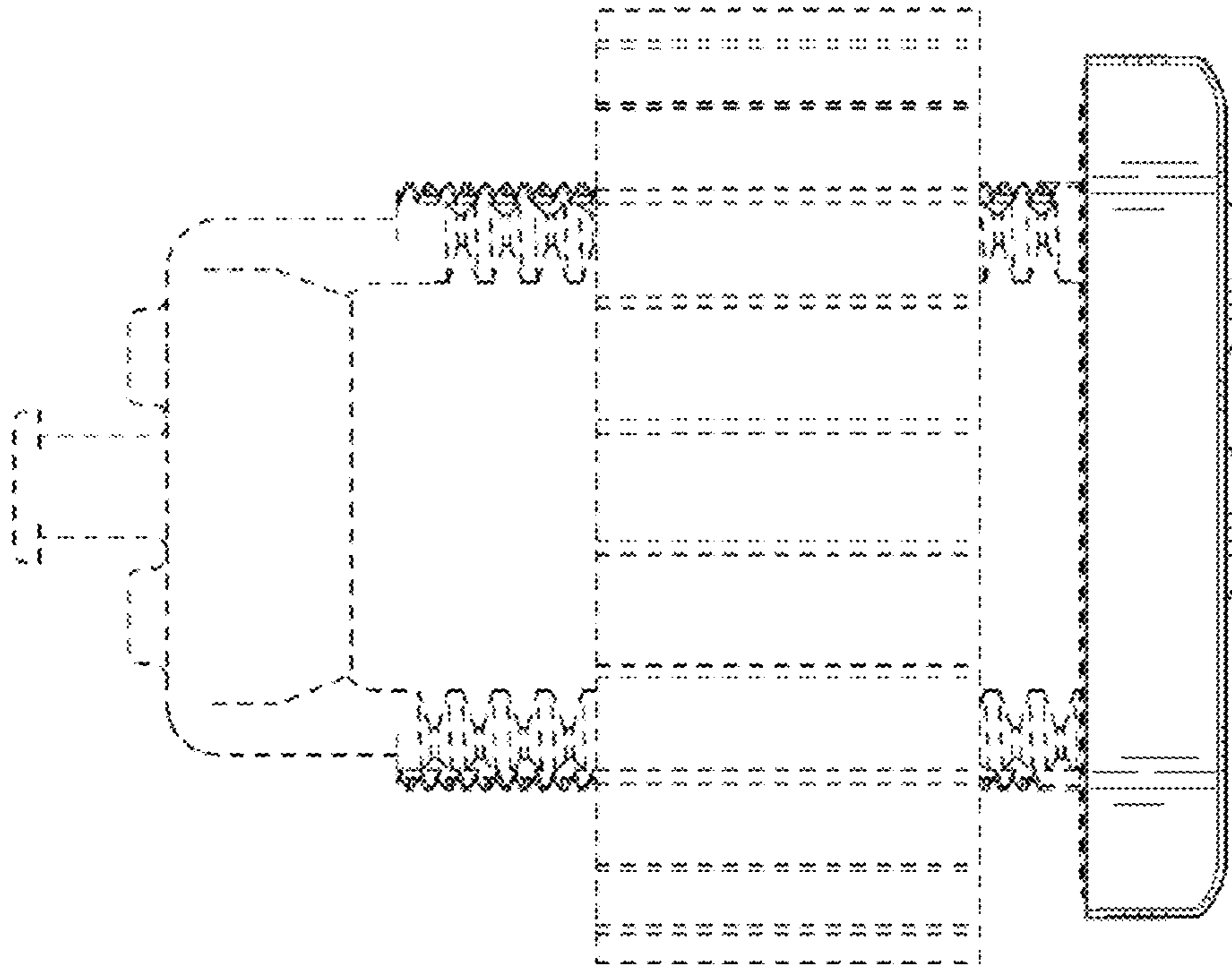

FIG. 11

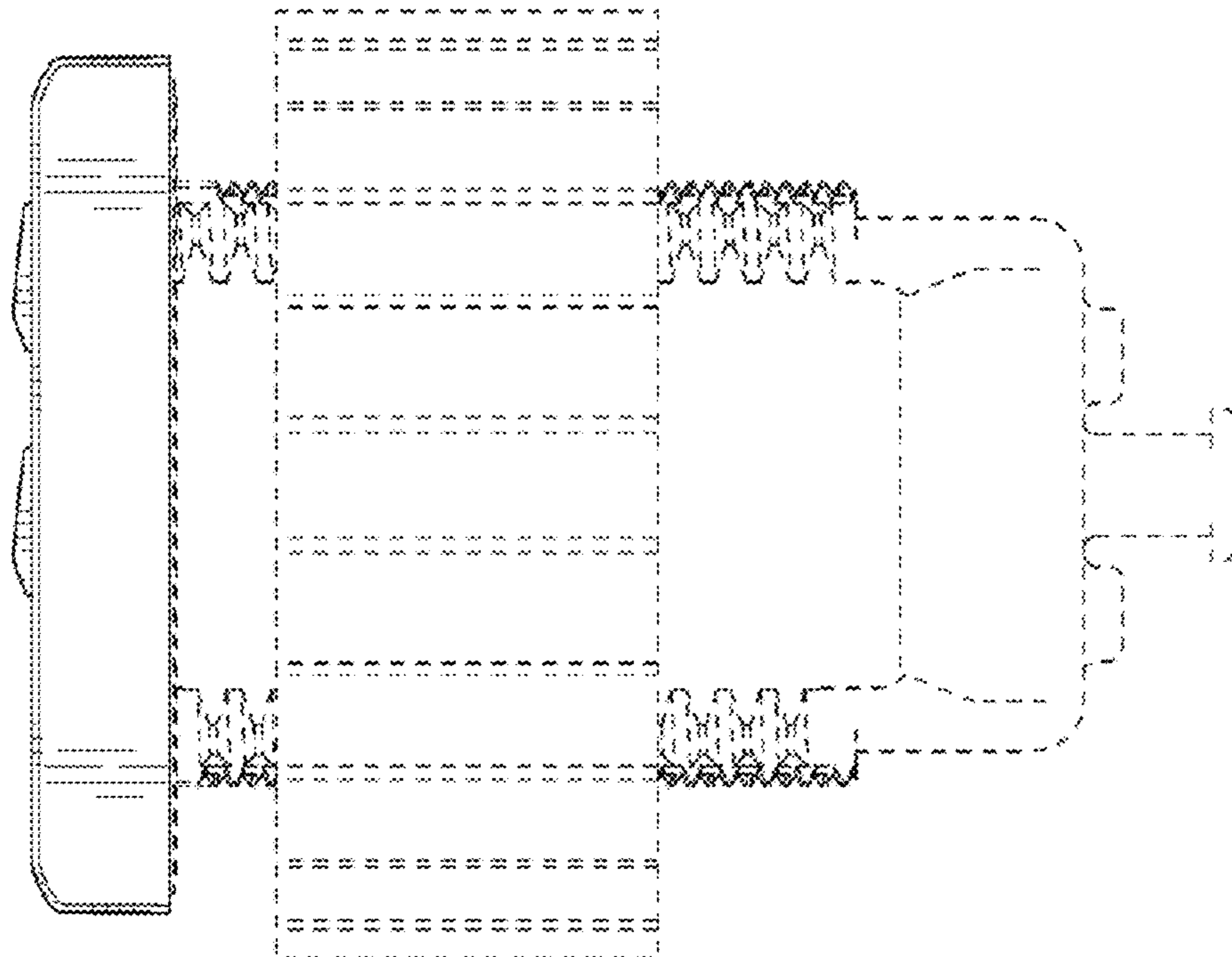

FIG. 12

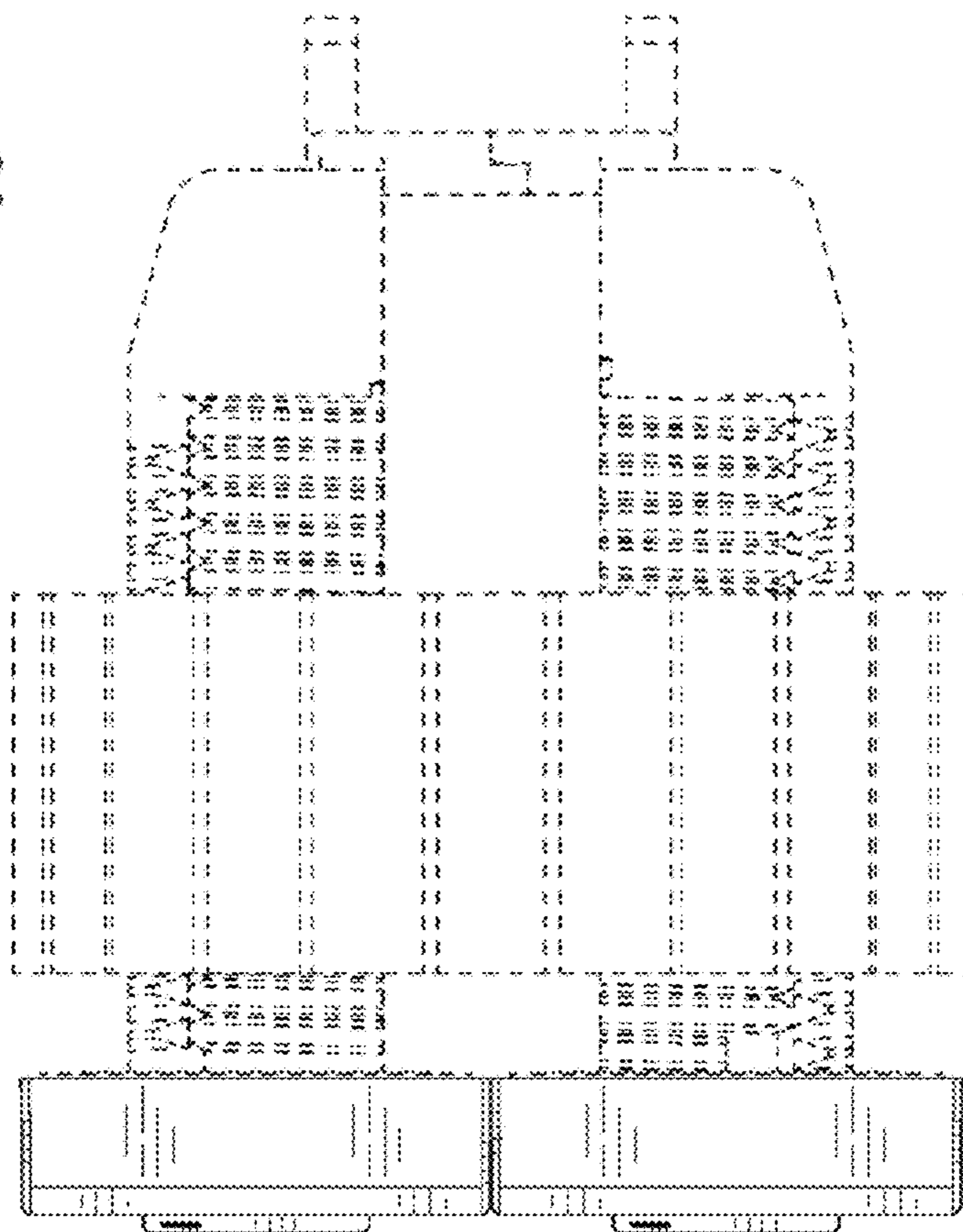

FIG. 13

