



US00D932374S

(12) **United States Design Patent**
Cattabriga et al.

(10) **Patent No.:** **US D932,374 S**

(45) **Date of Patent:** **** Oct. 5, 2021**

(54) **DECORATIVE ORNAMENT WITH SURFACE ORNAMENTATION**

D617,683 S * 6/2010 Beneggi D12/92
D710,259 S * 8/2014 Baccino D12/92
D718,667 S * 12/2014 Manzoni D12/92
D753,548 S * 4/2016 Gilles D12/88

(71) Applicant: **Ferrari S.p.A.**, Modena (IT)

(Continued)

(72) Inventors: **Adalberto Cattabriga**, Modena (IT);
Matteo Biancalana, Modena (IT);
Luca Zanetti, Modena (IT)

Primary Examiner — Sheryl Lane

Assistant Examiner — Calvin E Vansant

(73) Assignee: **FERRARI S.p.A.**, Modena (IT)

(74) *Attorney, Agent, or Firm* — Cowan, Liebowitz & Latman, P.C.; Anastasia Zhadina

(**) Term: **15 Years**

(57) **CLAIM**

(21) Appl. No.: **29/771,653**

The ornamental design for a decorative ornament with surface ornamentation, as shown and described.

(22) Filed: **Feb. 24, 2021**

DESCRIPTION

Related U.S. Application Data

(62) Division of application No. 35/508,023, filed on Mar. 14, 2019 (U.S. filing date under 35 U.S.C. 384), and having an international filing date of Mar. 14, 2019, now Pat. No. Des. 921,529.

The patent or application file contains at least one drawing executed in color. Copies of this patent or patent application publication with color drawing(s) will be provided by the Office upon request and payment of the necessary fee.

(30) **Foreign Application Priority Data**

Sep. 14, 2018 (EM) 005641305

FIG. 1 is a front perspective view of a first embodiment of the decorative ornament with surface ornamentation showing my design;

(51) **LOC (13) Cl.** **12-08**

FIG. 2 is a rear perspective view thereof;

(52) **U.S. Cl.**

USPC **D12/86; D11/163**

FIG. 3 is a front view thereof;

(58) **Field of Classification Search**

USPC D12/86, 88, 90-92, 184, 196; D21/424, D21/433, 434, 533, 548; D11/163

FIG. 4 is a rear view thereof;

CPC B62D 25/00; B62D 25/02; B62D 25/06; B62D 35/00; B62D 35/005; B60J 5/04

FIG. 5 is a right-side view thereof;

See application file for complete search history.

FIG. 6 is a top plan view thereof;

FIG. 7 is a bottom view thereof;

FIG. 8 is a front perspective view of a second embodiment of the decorative ornament with surface ornamentation showing my design;

(56) **References Cited**

U.S. PATENT DOCUMENTS

D515,486 S * 2/2006 Yokomaku D12/190
D534,847 S * 1/2007 Yokomaku D12/190

FIG. 9 is a rear perspective view thereof;

FIG. 10 is a front view thereof;

FIG. 11 is a rear view thereof;

FIG. 12 is a right-side view thereof;

FIG. 13 is a top plan view thereof; and,

FIG. 14 is a bottom view thereof.

1 Claim, 14 Drawing Sheets
(7 of 14 Drawing Sheet(s) Filed in Color)

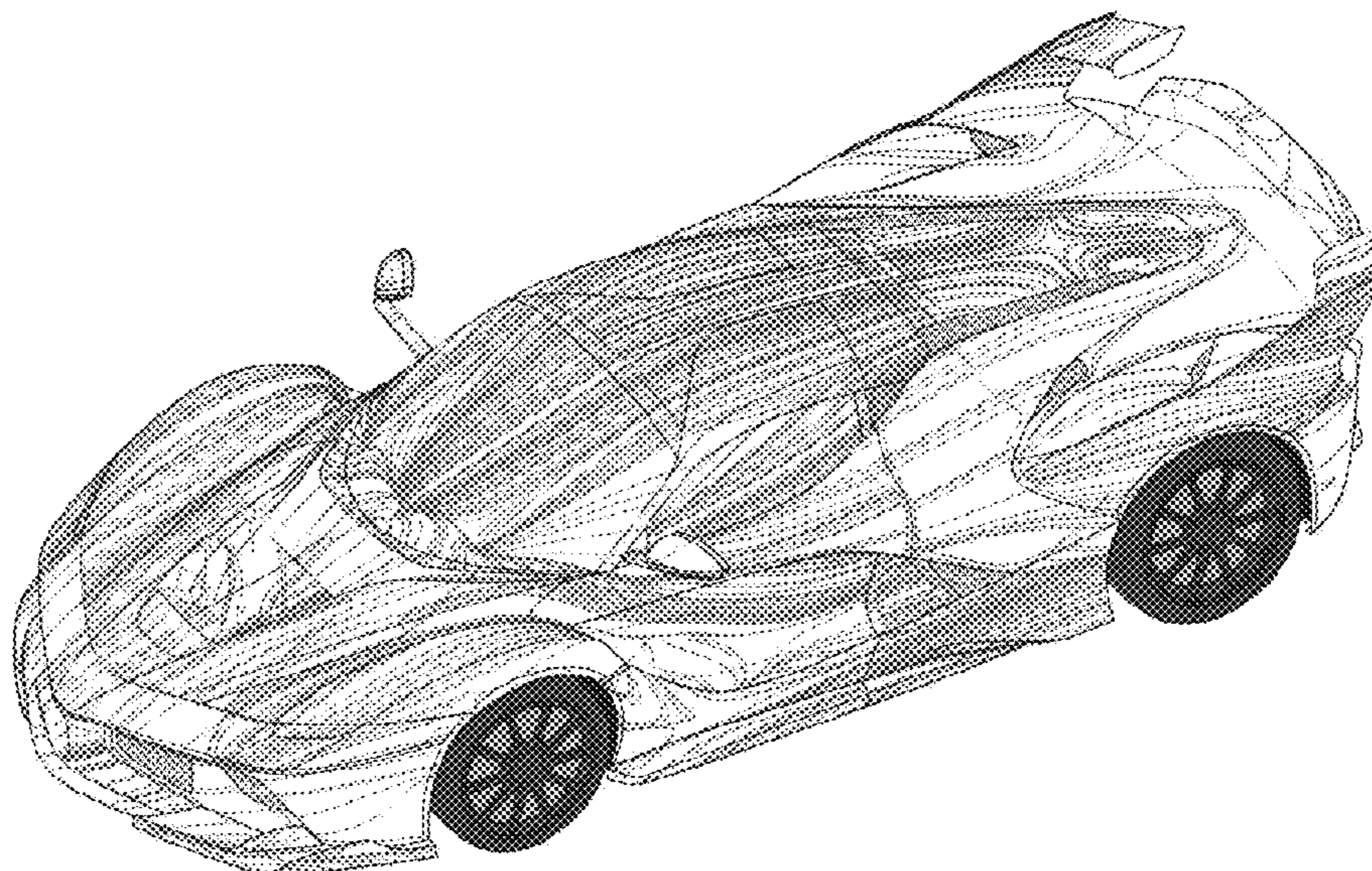

(56)

References Cited

U.S. PATENT DOCUMENTS

D753,549	S	*	4/2016	Manzoni	D12/88
D780,063	S	*	2/2017	Stephenson	D12/88
D813,095	S	*	3/2018	Manzoni	D12/88
D821,267	S	*	6/2018	Borkert	D12/92
D823,724	S	*	7/2018	Melville	D12/92
D826,092	S	*	8/2018	Manzoni	D12/92
D826,784	S	*	8/2018	Hauser	D12/92
D833,912	S	*	11/2018	Manzoni	D12/88
D834,998	S	*	12/2018	Manzoni	D12/88
D842,787	S	*	3/2019	Manzoni	D12/196
D868,647	S	*	12/2019	Buck	D12/169
D873,178	S	*	1/2020	Howse	D12/92
D881,075	S	*	4/2020	Larson	D12/92
2019/0009842	A1	*	1/2019	Biancalana	B62D 35/007

* cited by examiner

FIG. 1

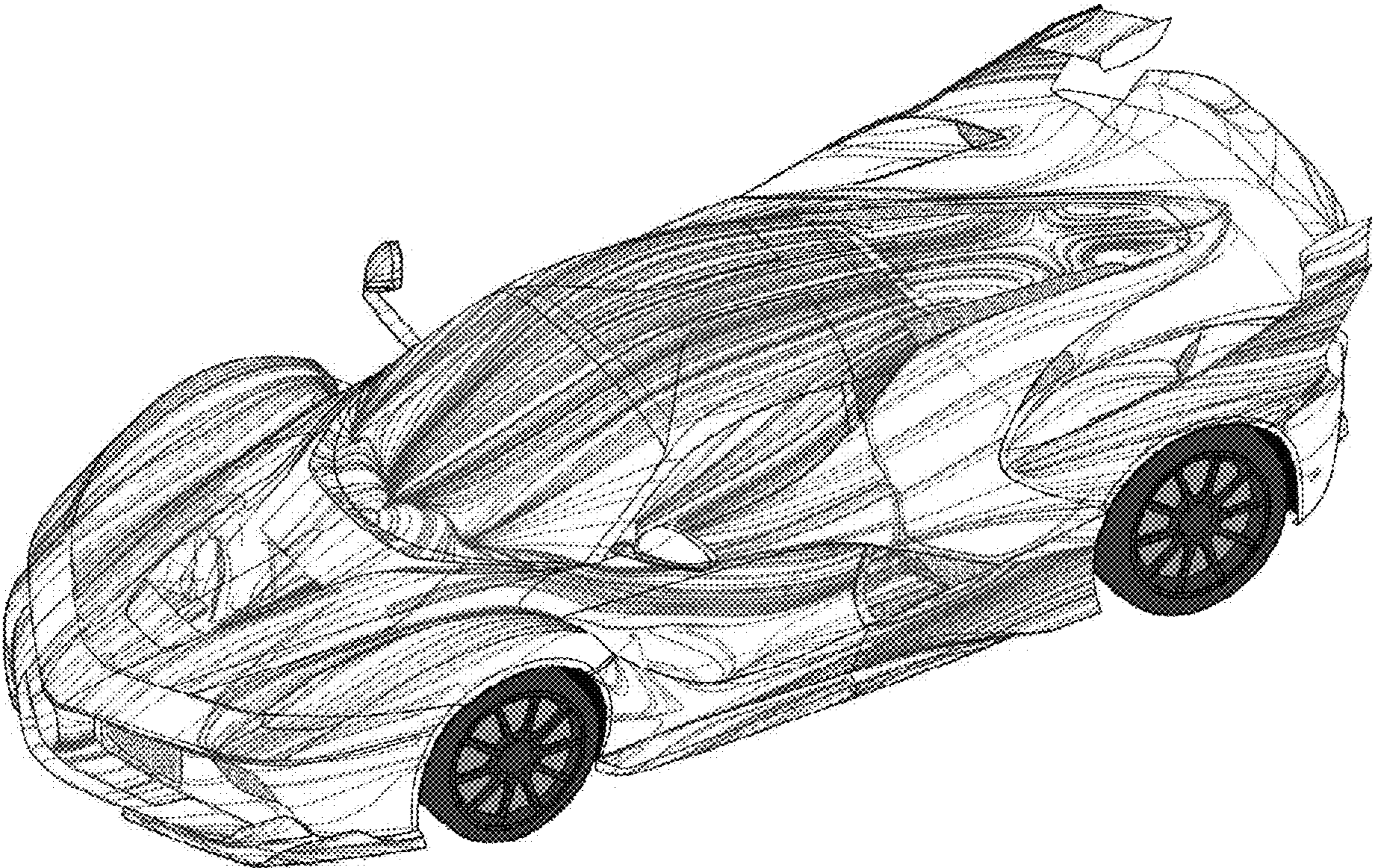

FIG. 2

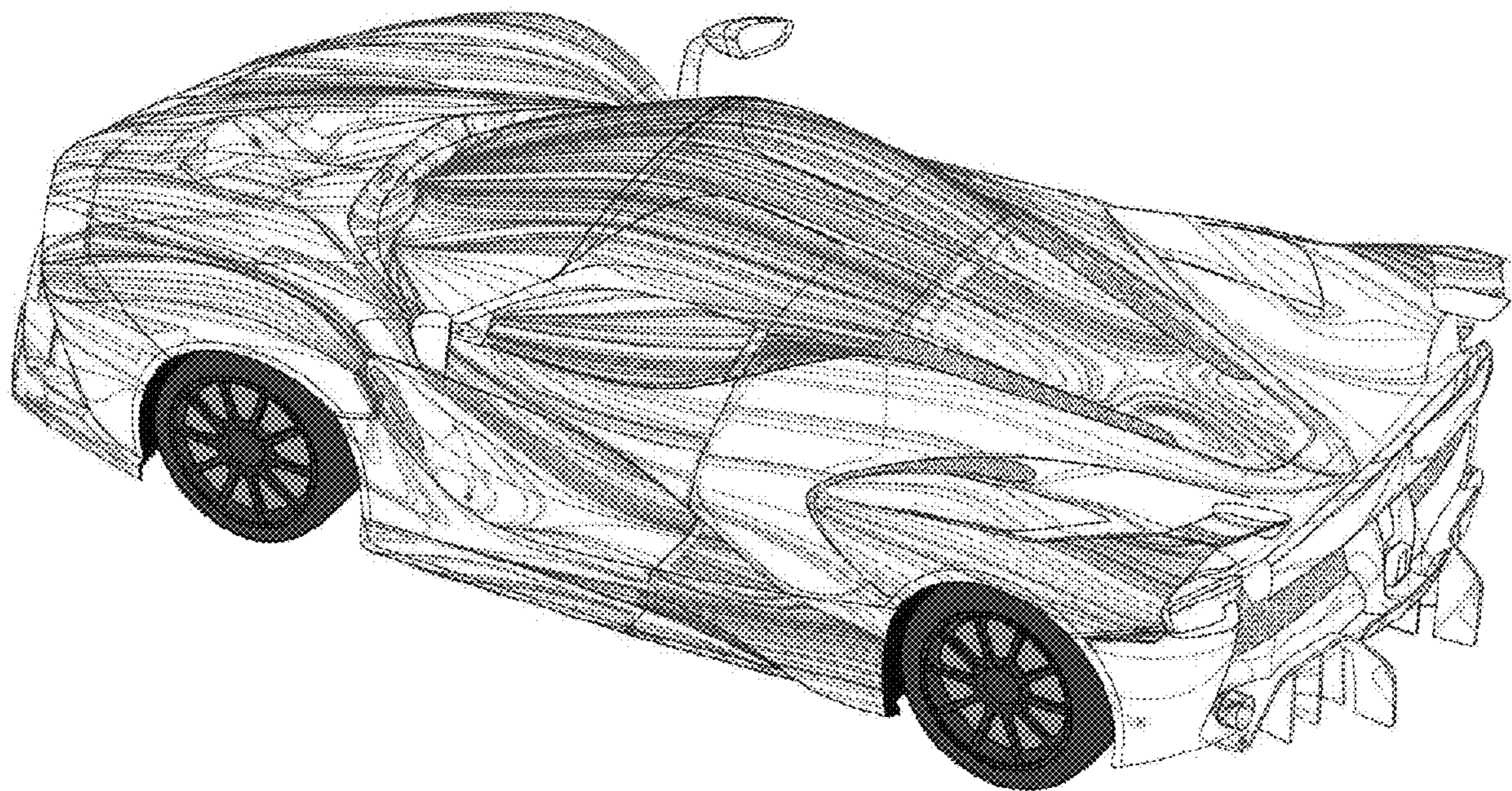

FIG. 3

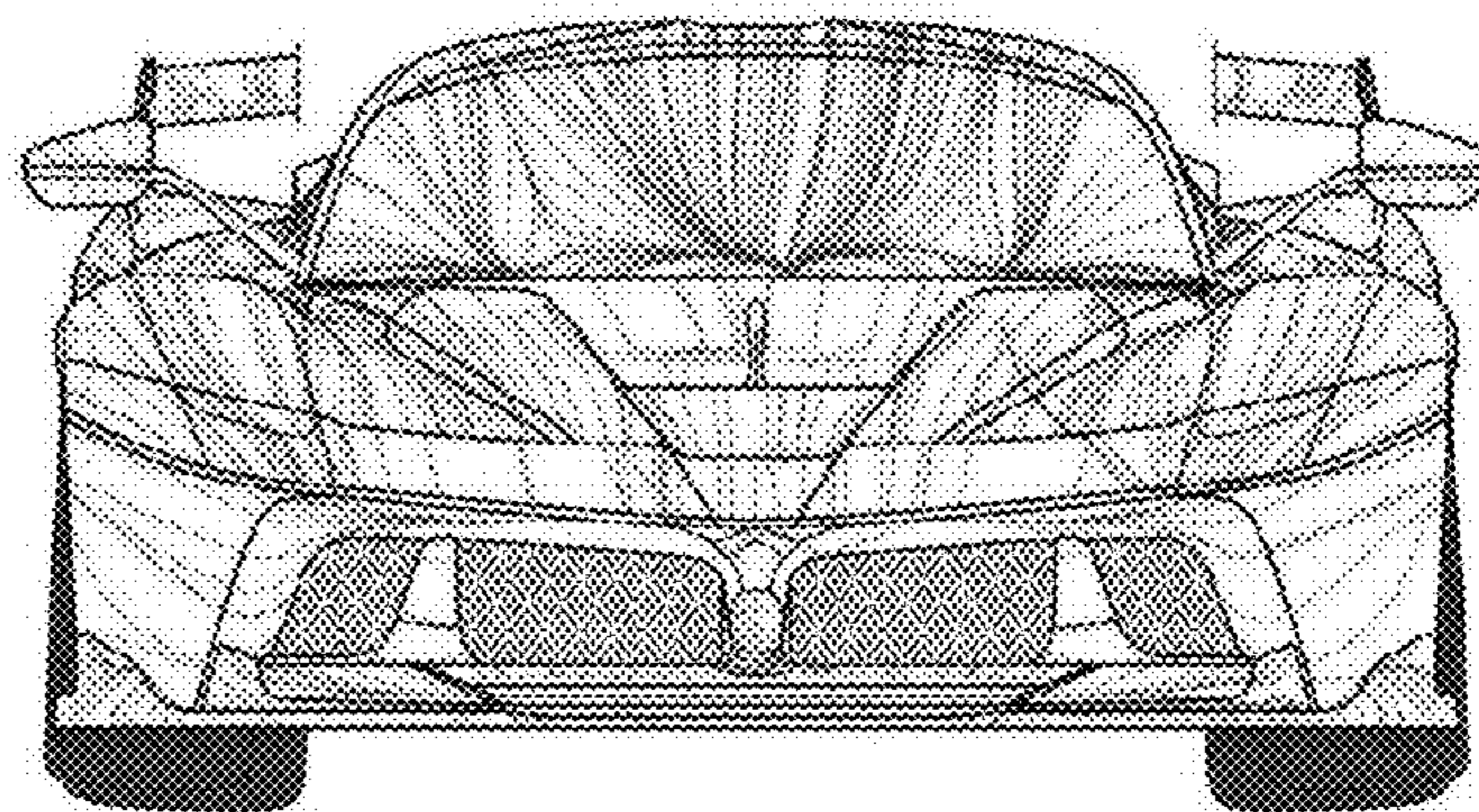

FIG. 4

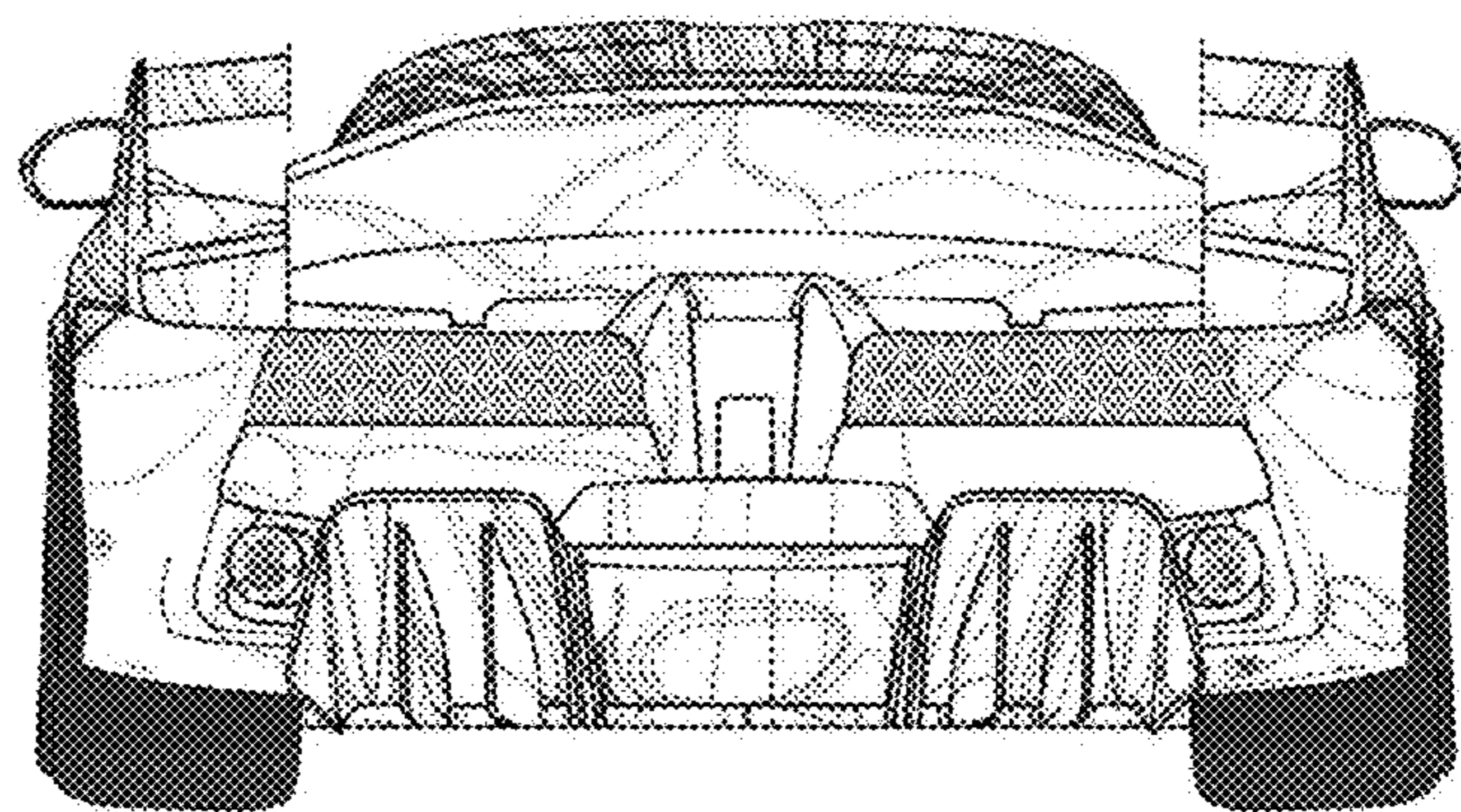

FIG. 5

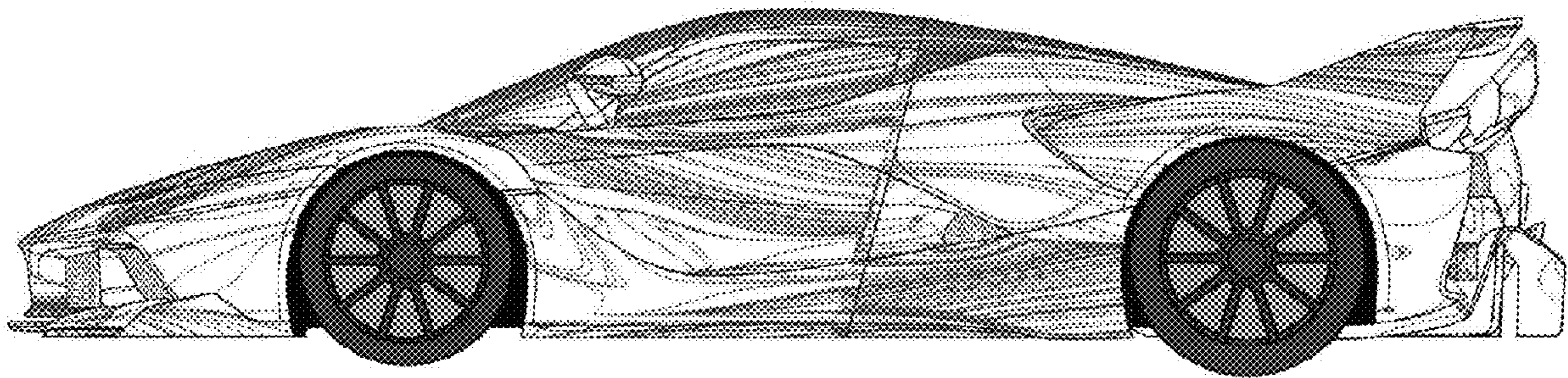

FIG. 6

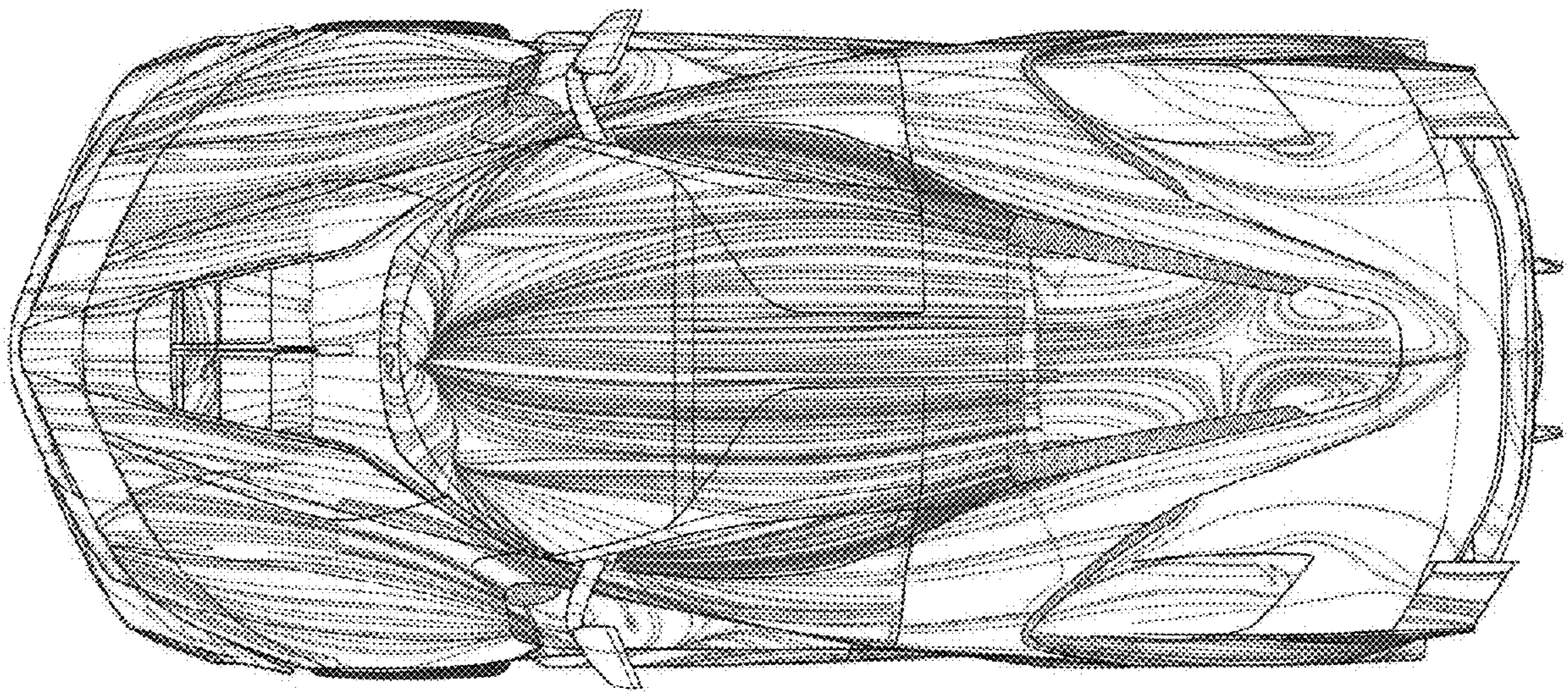

FIG. 7

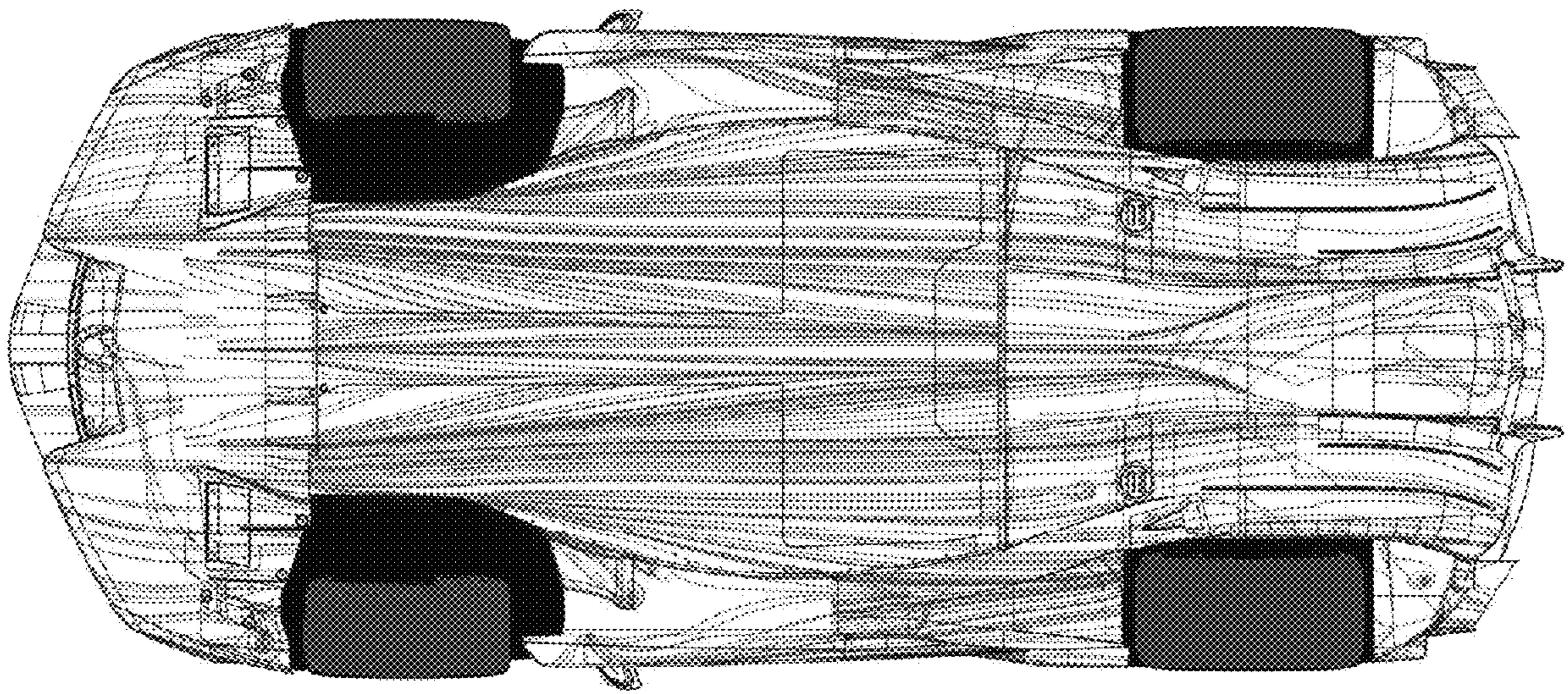

FIG. 8

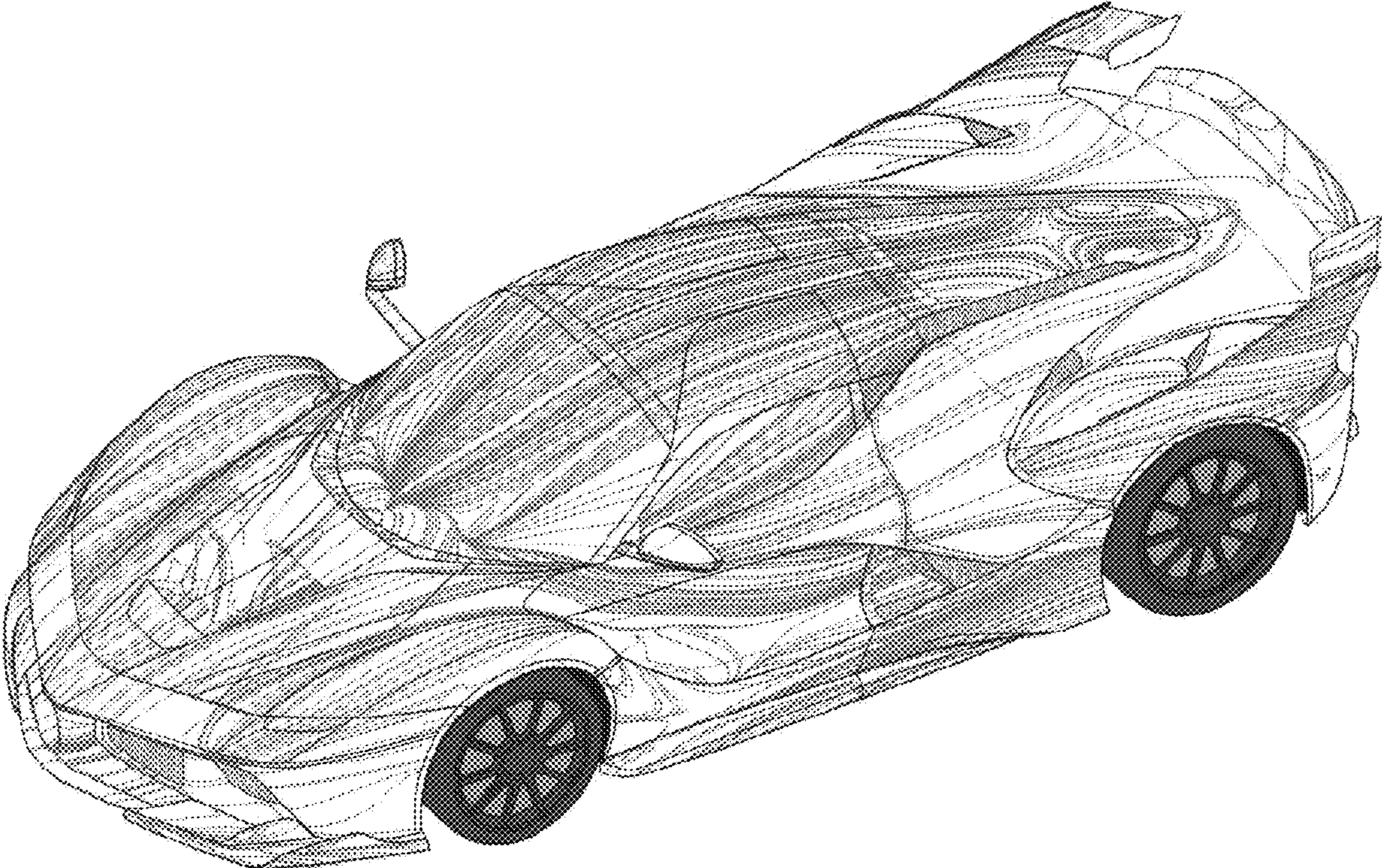

FIG. 9

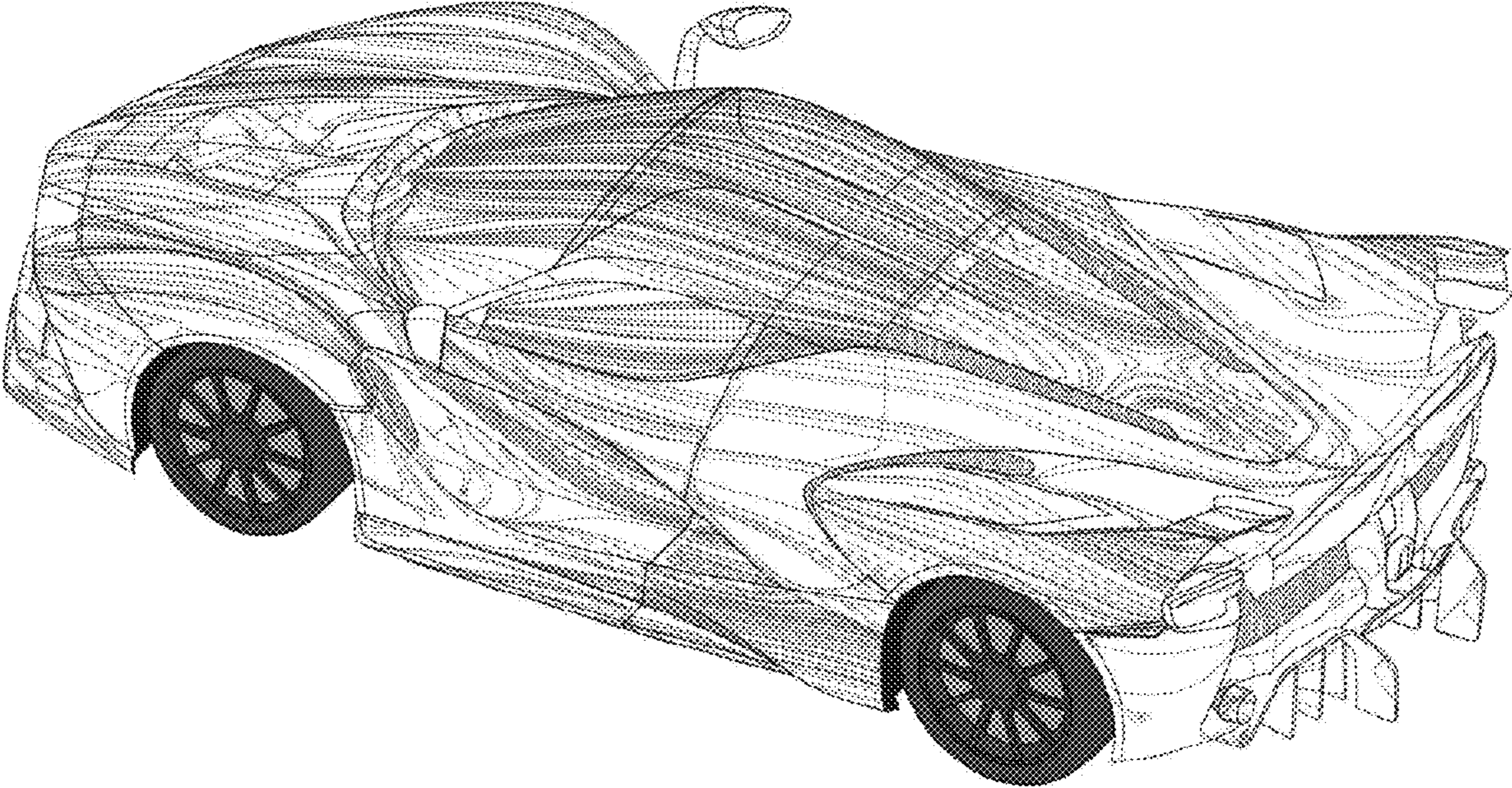

FIG. 10

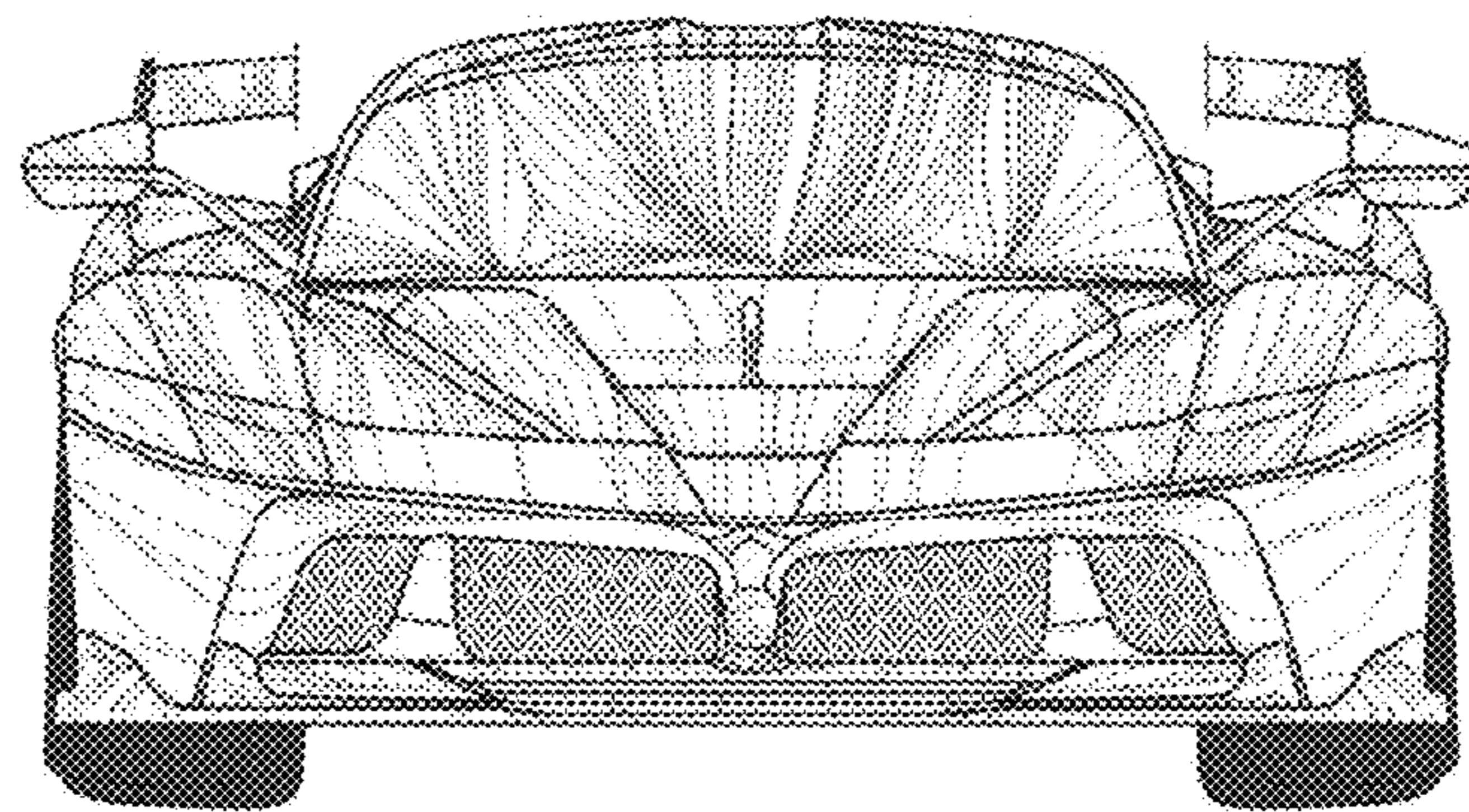

FIG. 11

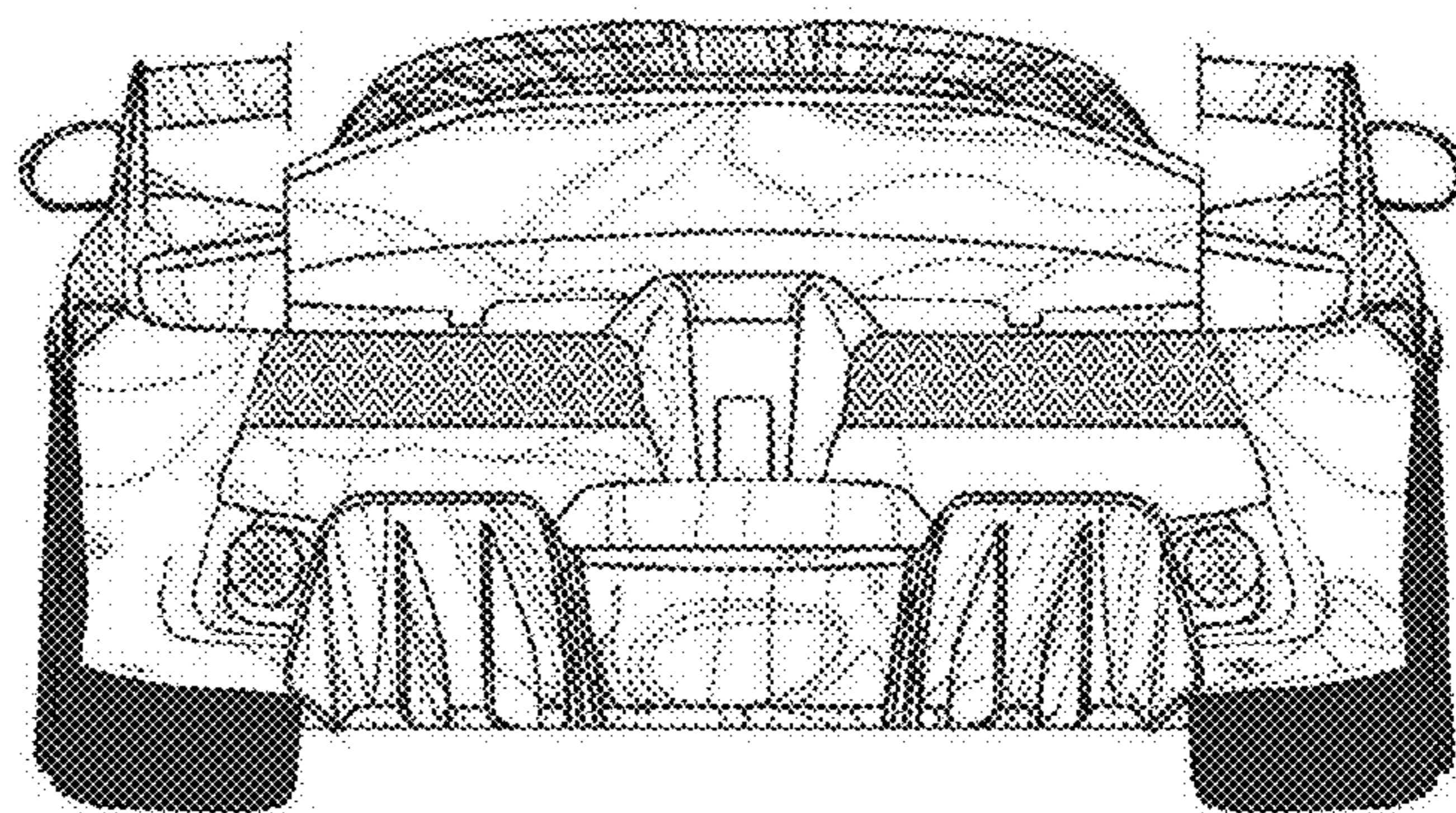

FIG. 12

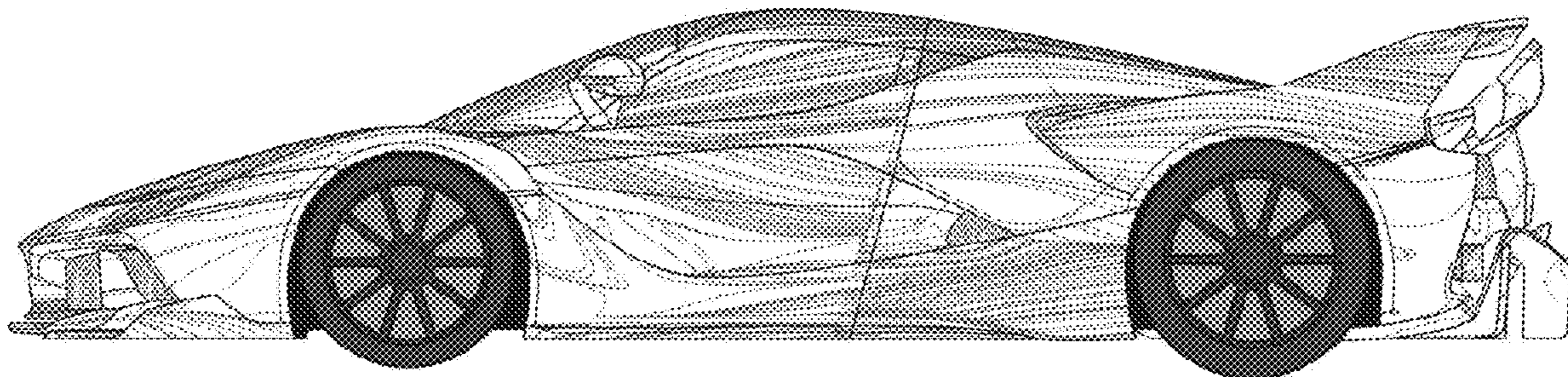

FIG. 13

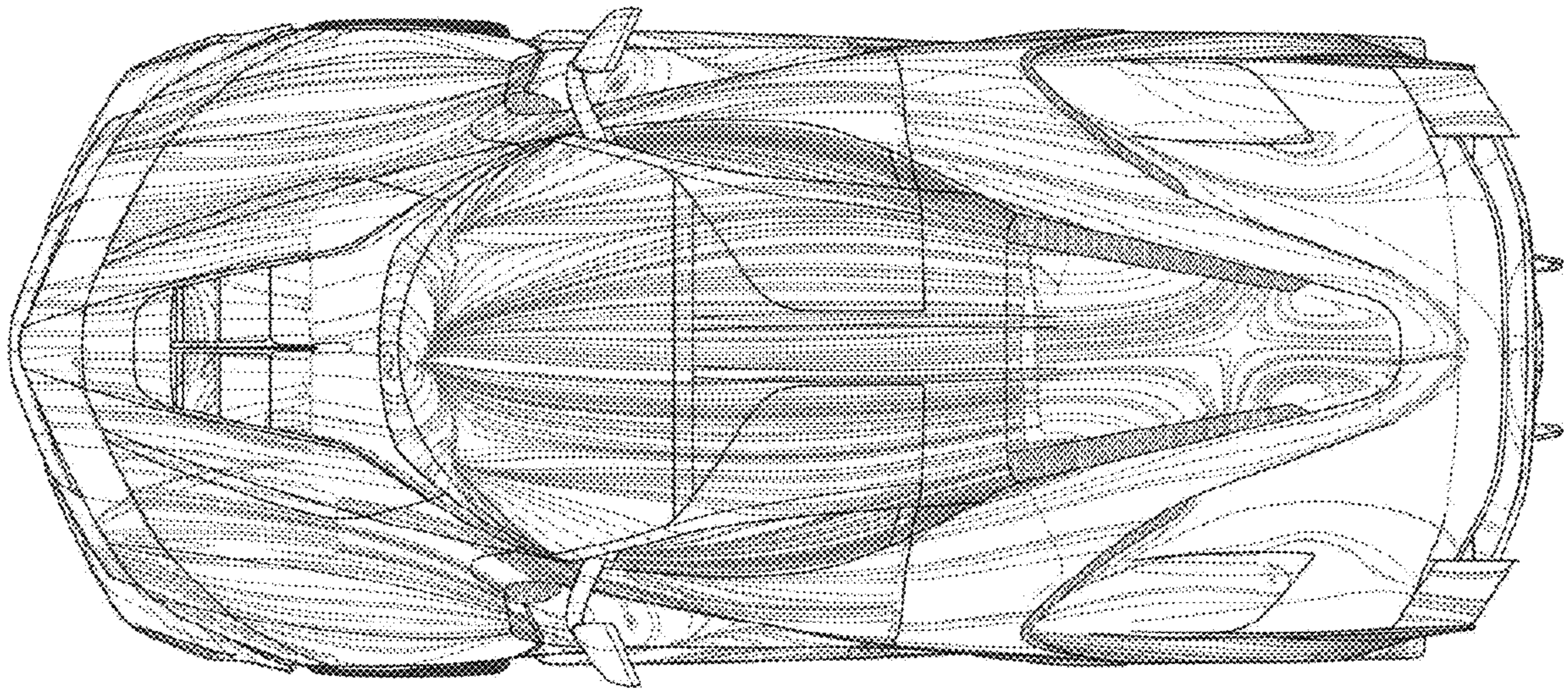

FIG. 14

