



US00D932322S

(12) **United States Design Patent** (10) **Patent No.:** **US D932,322 S**  
**Fischer et al.** (45) **Date of Patent:** **\*\* Oct. 5, 2021**

(54) **WATCH CASING WITH DIAL**

(56) **References Cited**

(71) Applicant: **VANGUART Ltd**, La Chaux-de-Fonds (CH)

U.S. PATENT DOCUMENTS

(72) Inventors: **Thierry Fischer**, Neuchâtel (CH);  
**Jérémy Freléchox**, Les Bois (CH);  
**Axel Leuenberger**, Eschert (CH)

D573,488 S *	7/2008	Sanz	.....	D10/39
D601,044 S *	9/2009	Lalo	.....	D10/39
D702,568 S *	4/2014	Lalo	.....	D10/38
D913,121 S *	3/2021	Lalo	.....	D10/39

\* cited by examiner

(\*\*) Term: **15 Years**

*Primary Examiner* — George D. Kirschbaum

(21) Appl. No.: **35/509,701**

(57) **CLAIM**

(22) Filed: **Dec. 24, 2019**

The ornamental design for a watch casing with dial, as shown and described.

(80) **Hague Agreement Data**

**DESCRIPTION**

Int. Filing Date: **Dec. 24, 2019**

1. Watch casing with dial

Int. Reg. No.: **DM/205279**

1.1 : Perspective

Int. Reg. Date: **Dec. 24, 2019**

1.2 : Top

Int. Reg. Pub. Date: **Jun. 26, 2020**

1.3 : Back

(51) **LOC (13) Cl.** ..... **10-02**

1.4 : Right

(52) **U.S. Cl.**

1.5 : Left

USPC ..... **D10/39**

1.6 : Front

(58) **Field of Classification Search**

1.7 : Back

USPC ..... **D10/32, 38, 39**

1.8 : Perspective

See application file for complete search history.

**1 Claim, 8 Drawing Sheets**

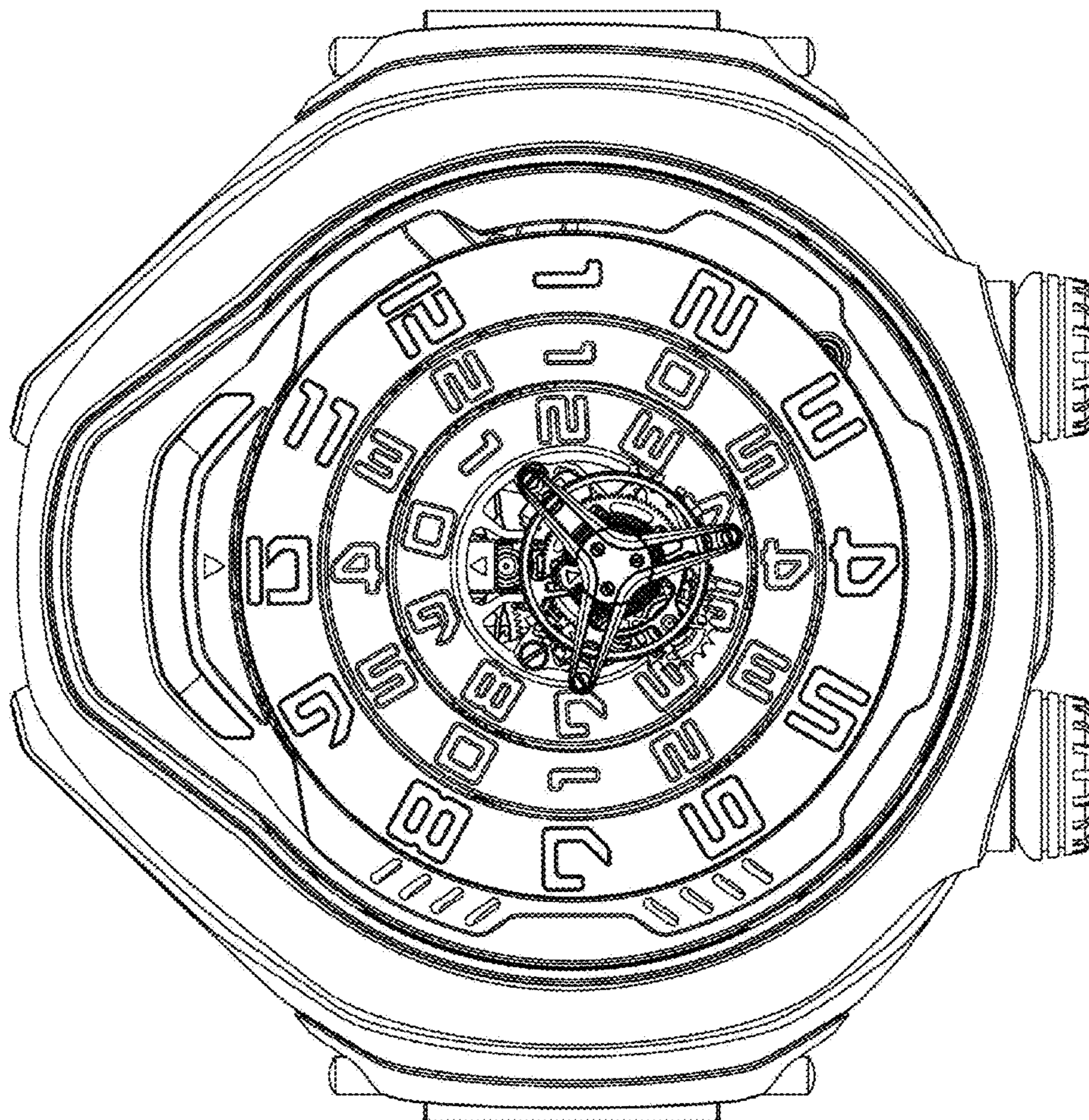

1.1

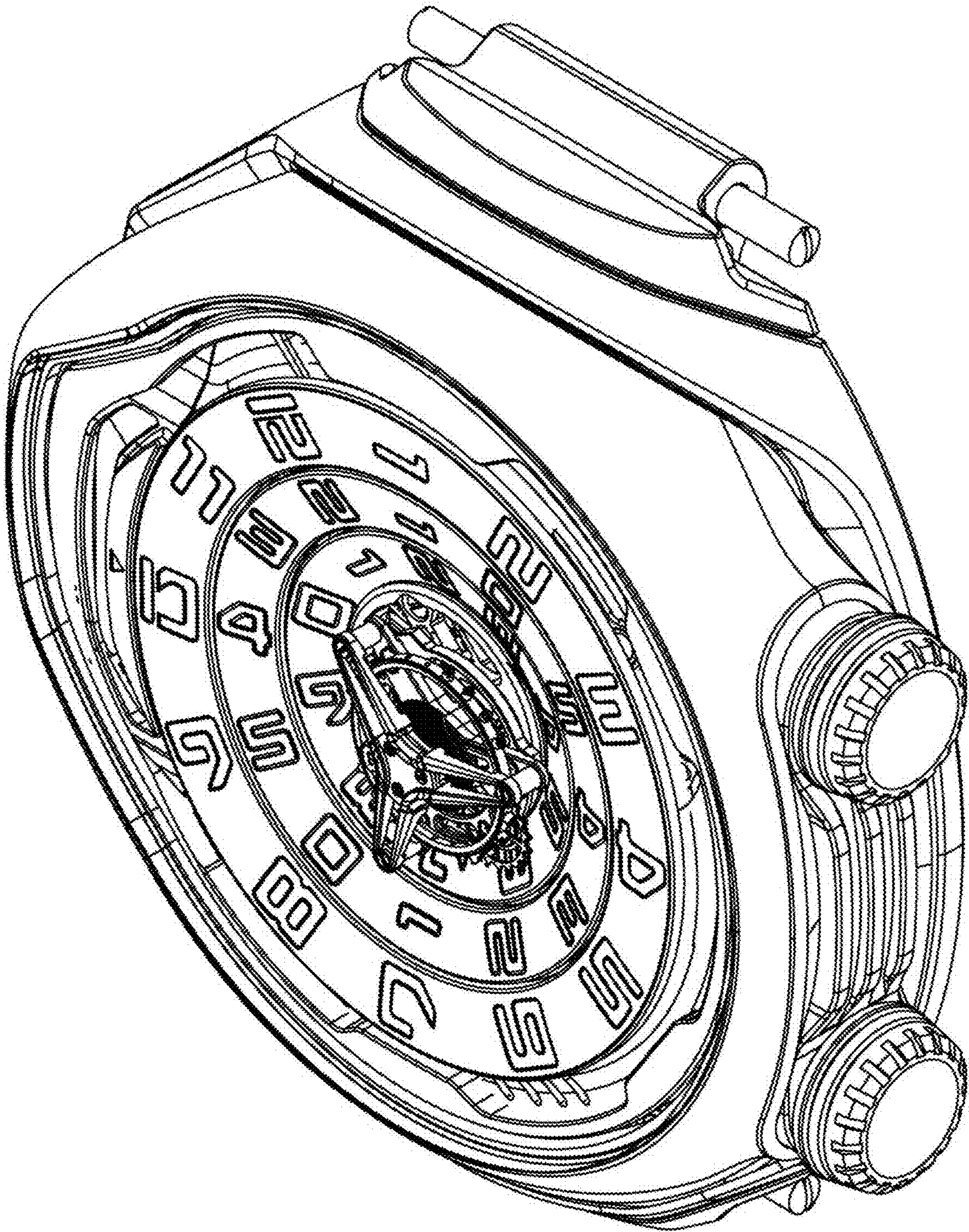

1.2

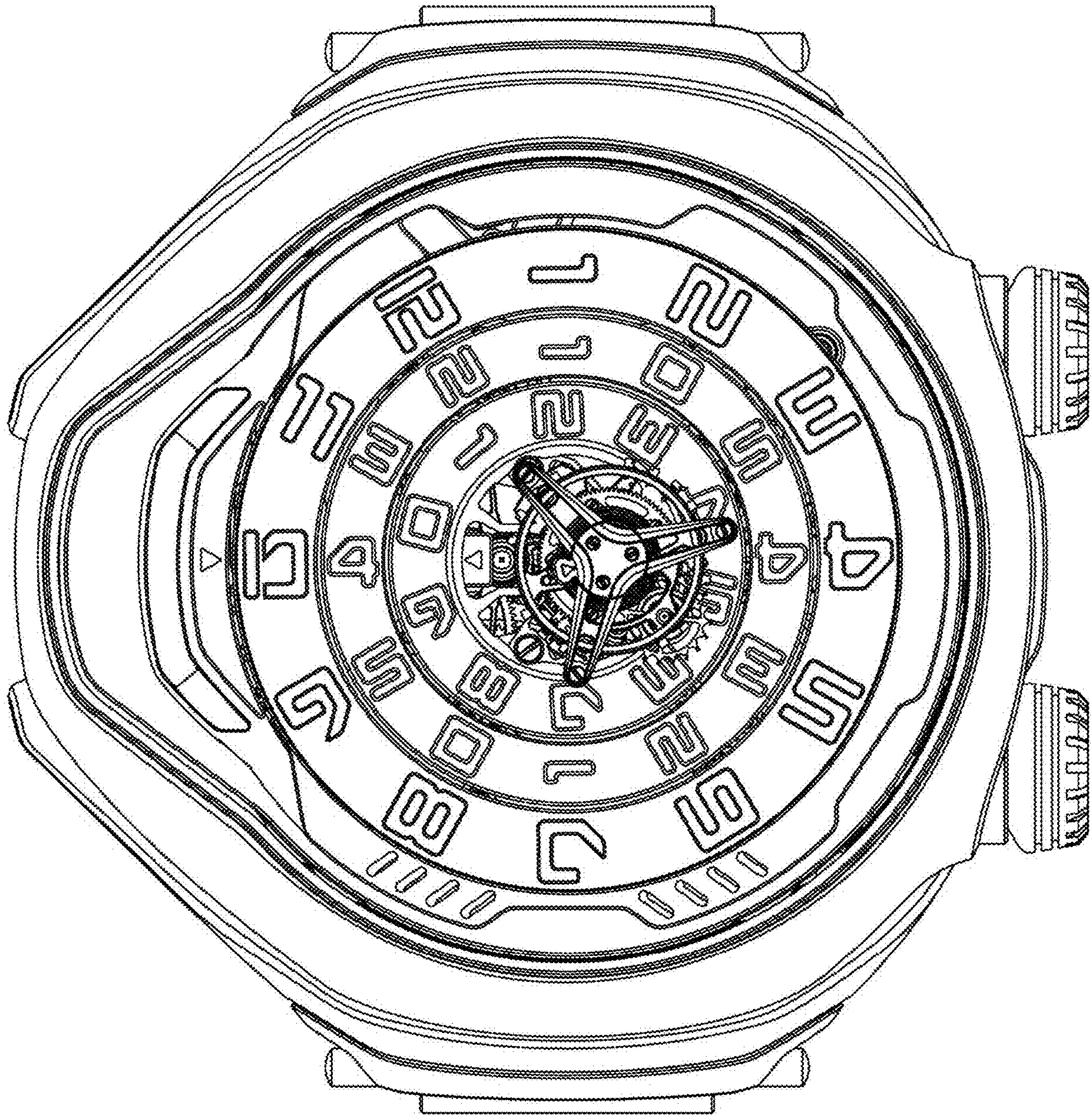

1.3

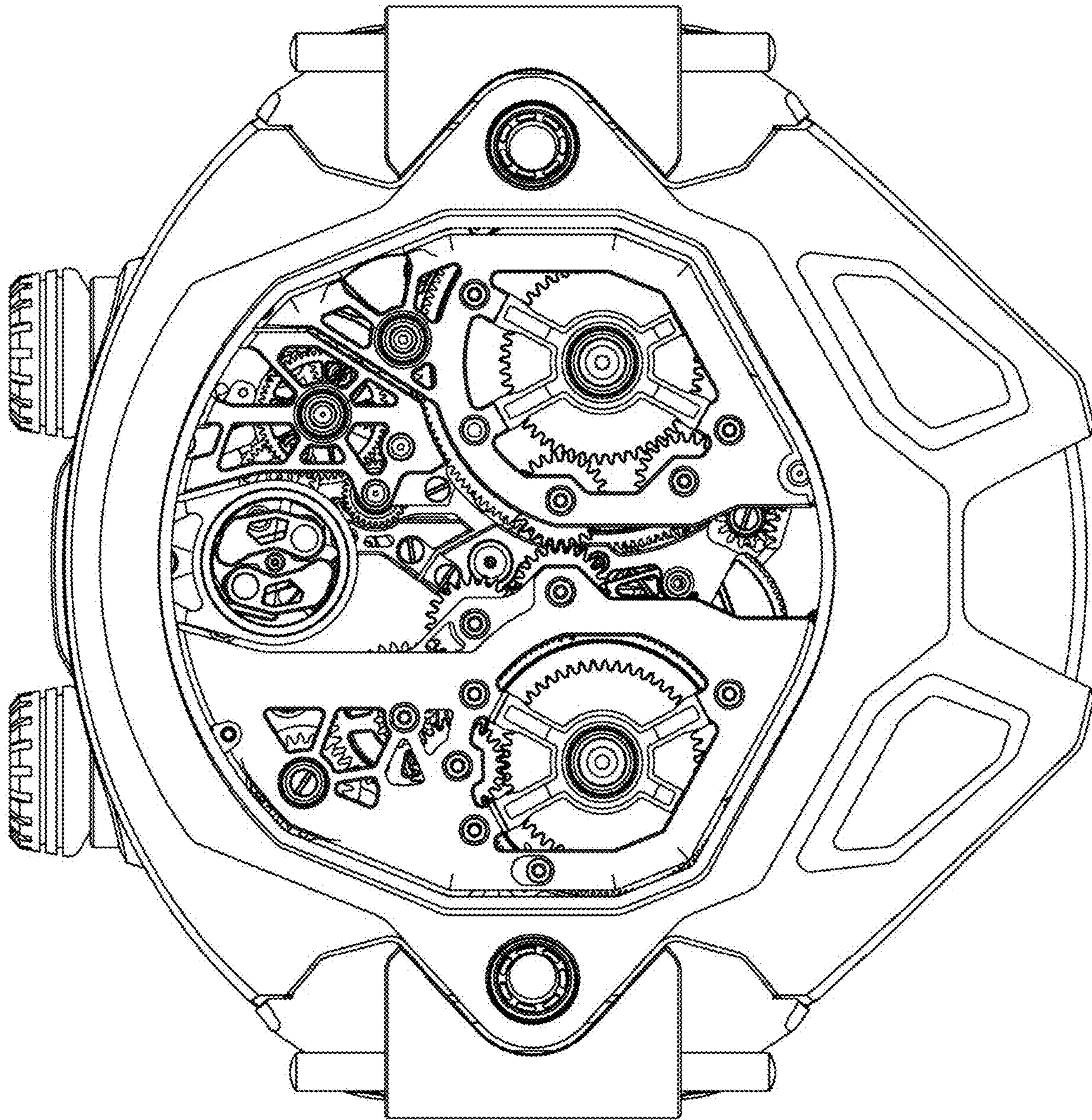

1.4

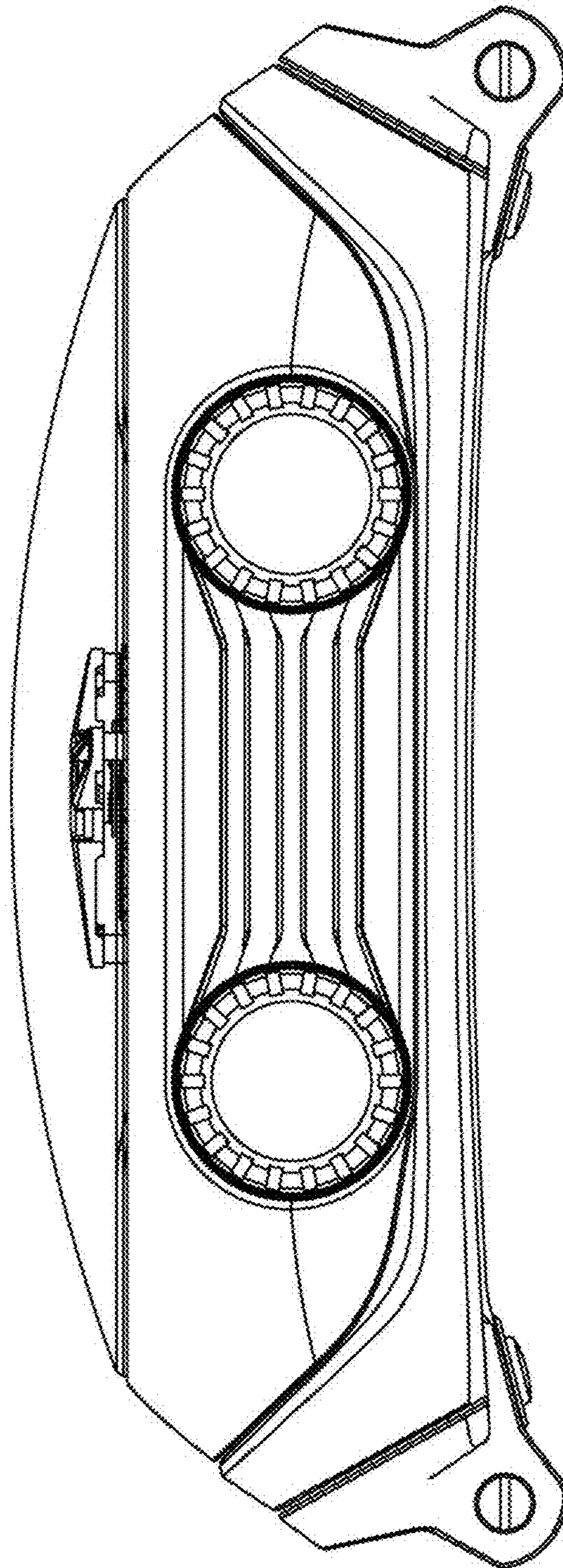

1.5

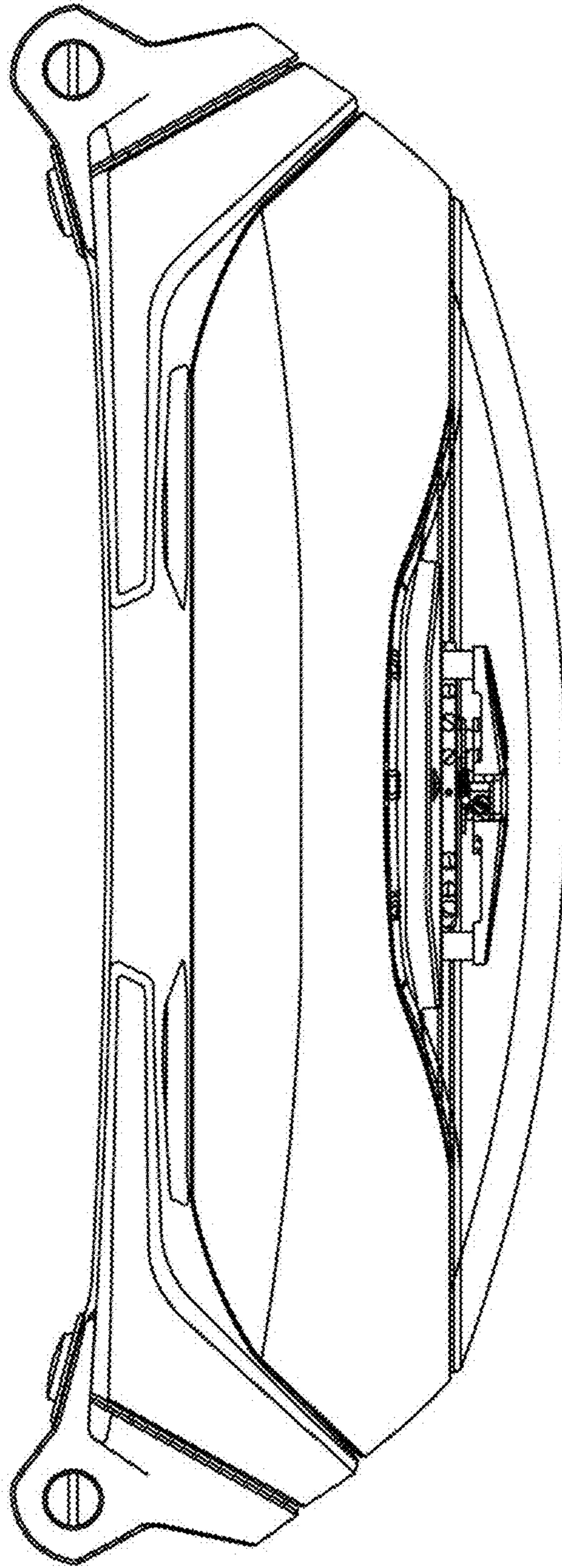

1.6

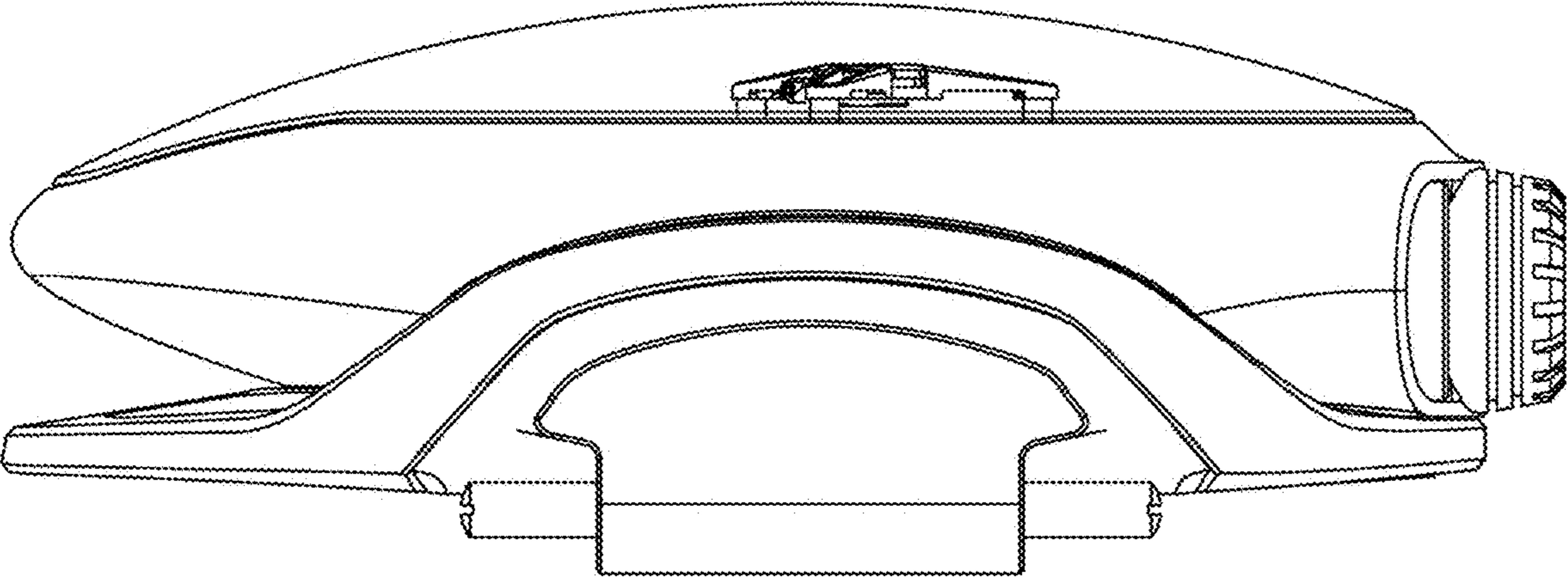

1.7

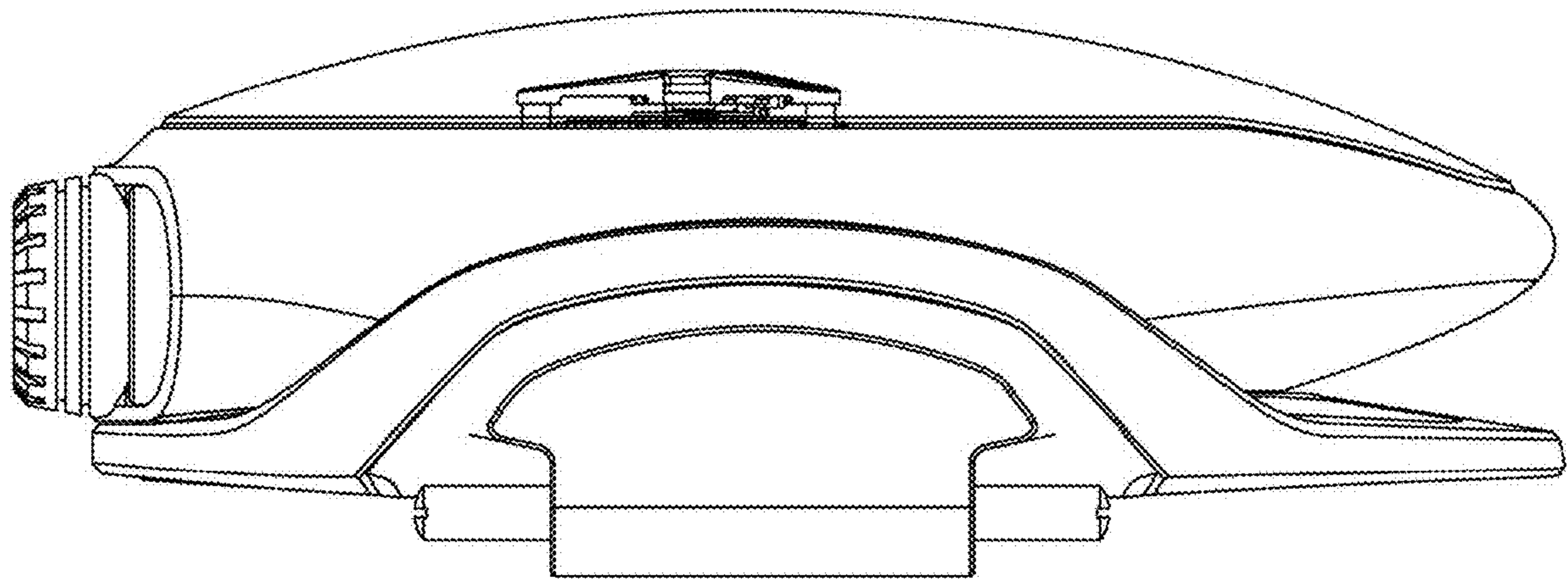



1.8

