



US00D932313S

(12) **United States Design Patent** (10) **Patent No.:** **US D932,313 S**
Cartis et al. (45) **Date of Patent:** **** Oct. 5, 2021**

(54) **BOTTLE**

(71) Applicant: **PepsiCo, Inc.**, Purchase, NY (US)
(72) Inventors: **Emilian Dan Cartis**, London (GB); **Balazs Kovacs**, London (GB); **Philippe Leys**, Oostduinkerke (BE); **Ted Murphy**, Cork (IE); **Denis O’Callaghan**, Cork (IE); **Emma Caselton**, London (GB)

(73) Assignee: **PepsiCo, Inc.**, Purchase, NY (US)

(**) Term: **15 Years**

(21) Appl. No.: **29/743,545**

(22) Filed: **Jul. 22, 2020**

Related U.S. Application Data

(63) Continuation of application No. 29/691,783, filed on May 20, 2019, now Pat. No. Des. 893,307, which is a continuation of application No. 29/677,327, filed on Jan. 18, 2019, now Pat. No. Des. 893,305.

(51) **LOC (13) Cl.** **09-01**

(52) **U.S. Cl.**
USPC **D9/560**; D9/516; D9/563; D9/574

(58) **Field of Classification Search**
USPC D9/434, 505, 516, 540, 550, 560, 668, D9/670, 681, 687, 694, 700, 537, 538, D9/500, 520, 539, 503, 558, 690, 552, D9/556, 530, 541, 522, 448, 566, 454, D9/542, 559, 574, 563; D7/500–506, D7/508–524

CPC .. B65D 1/0223; B65D 83/205; B65D 83/206; B65D 2501/0081; B65D 79/005; B65D 2501/0036; B65D 1/0276; B65D 1/0284; Y10S 220/906; B29L 2031/7158; B29B 2911/14026; B29C 49/06; B29C 49/0005

See application file for complete search history.

(56) **References Cited**

U.S. PATENT DOCUMENTS

D29,673 S 11/1898 Nightingale
D56,983 S 1/1921 Lewis
D103,987 S 4/1937 Ennever
D107,586 S * 12/1937 Toulhouse D9/500
D119,303 S 3/1940 Deletzke
D132,180 S 4/1942 Ireys
D187,399 S * 3/1960 Campbell D9/500
(Continued)

FOREIGN PATENT DOCUMENTS

BR 302012000578-7 3/2013
CA 106315 3/2006
(Continued)

Primary Examiner — Brett Miller
Assistant Examiner — Rani J Abdallah
(74) *Attorney, Agent, or Firm* — Sterne, Kessler, Goldstein & Fox P.L.L.C.

(57) **CLAIM**

The ornamental design for a bottle, as shown and described.

DESCRIPTION

FIG. 1 is a top front perspective view of a bottle showing the claimed design;
FIG. 2 is a bottom rear perspective view thereof;
FIG. 3 is a front view thereof;
FIG. 4 is a rear view thereof;
FIG. 5 is a left side view thereof;
FIG. 6 is a right side view thereof;
FIG. 7 is a top view thereof; and,
FIG. 8 is a bottom view thereof.
The dashed broken lines in the figures show portions of the bottle that form no part of the claimed design.
The dot-dash broken lines in the figures show boundaries that form no part of the claimed design.

1 Claim, 7 Drawing Sheets

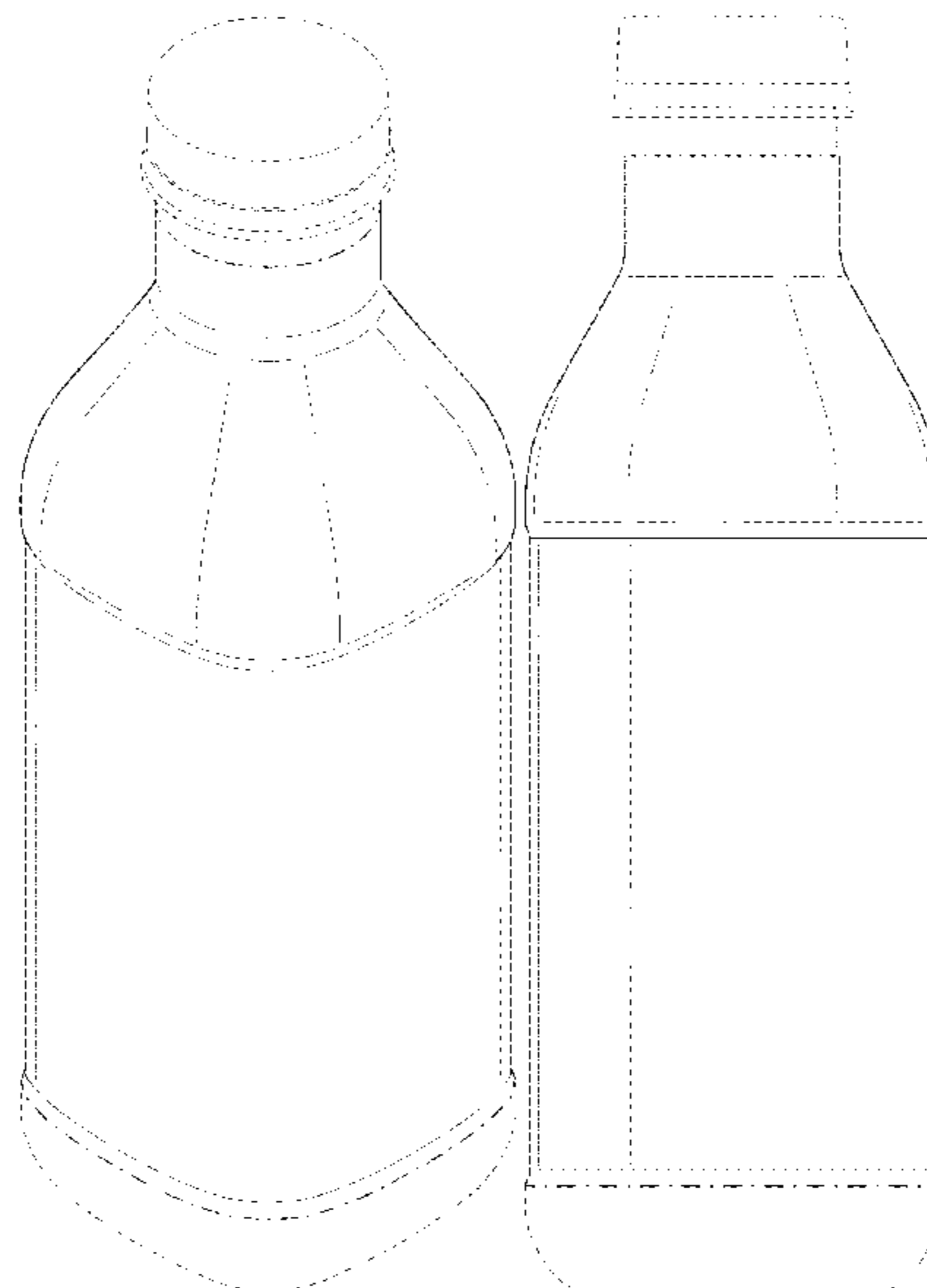

(56)

References Cited

U.S. PATENT DOCUMENTS

D208,953 S 10/1967 Belcher et al.
 D233,828 S 12/1974 Leary
 D236,587 S 9/1975 Krefa
 D266,741 S 11/1982 Cox
 D275,368 S * 9/1984 du Chambon D9/520
 D322,213 S 12/1991 Maginnis, Jr.
 D330,861 S * 11/1992 Lower D9/574
 D352,461 S 11/1994 Flanagan et al.
 D383,070 S * 9/1997 Workman D9/542
 D422,915 S * 4/2000 Hestehave D9/500
 D423,366 S 4/2000 Gans
 D425,793 S * 5/2000 Walker D9/503
 D426,161 S 6/2000 Hestehave et al.
 D426,469 S 6/2000 Mankowski et al.
 D428,576 S * 7/2000 Walker D9/503
 D435,455 S 12/2000 Gans
 D455,656 S 4/2002 Gans et al.
 D456,272 S 4/2002 Sadeghi et al.
 D458,146 S 6/2002 Sadeghi et al.
 D459,655 S * 7/2002 Darr D9/502
 D463,287 S 9/2002 Moore et al.
 D465,418 S 11/2002 Thierjung
 D468,645 S * 1/2003 Nelson D9/560
 D470,058 S 2/2003 Bryant et al.
 D471,466 S 3/2003 Nelson et al.
 D475,926 S * 6/2003 Rusnock D9/502
 D481,640 S 11/2003 Biesecker
 D482,978 S 12/2003 Nelson
 D484,415 S * 12/2003 Hadtke D9/500
 D488,060 S 4/2004 Yourist
 D491,068 S 6/2004 Heliste et al.
 D503,620 S * 4/2005 Taylor D9/560
 D510,529 S * 10/2005 Yates, III D9/552
 6,997,336 B2 2/2006 Yourist et al.
 D539,159 S 3/2007 Slat et al.
 D542,668 S * 5/2007 Arthur D9/560
 D569,261 S 5/2008 Sequiera
 D594,331 S 6/2009 Herb et al.
 D594,342 S 6/2009 Pare et al.
 D594,748 S 6/2009 Herb et al.
 D596,488 S 7/2009 Chupak
 D596,942 S 7/2009 Britto
 D605,047 S * 12/2009 Brindfors D9/502
 D610,017 S 2/2010 Howell et al.
 7,673,764 B2 3/2010 Sabold

D624,823 S 10/2010 Brown
 D646,178 S 10/2011 Barber et al.
 D655,179 S 3/2012 Kraft et al.
 D656,405 S 3/2012 Byron
 D664,857 S 8/2012 Finlay et al.
 D666,918 S 9/2012 Finlay et al.
 D691,893 S 10/2013 Finlay et al.
 D706,633 S * 6/2014 Reisig D9/500
 D719,455 S 12/2014 Perez-Cabrera
 D736,641 S 8/2015 Manne et al.
 D747,971 S * 1/2016 Peacock D9/563
 D758,875 S * 6/2016 Peacock D9/574
 D779,335 S 2/2017 Chia et al.
 D790,968 S * 7/2017 Thompson D9/500
 D798,161 S * 9/2017 Bayani D9/560
 D798,725 S 10/2017 Stoiber
 D802,434 S * 11/2017 Thompson D9/560
 D811,231 S * 2/2018 Thompson D9/560
 D815,952 S 4/2018 Chung
 D830,187 S 10/2018 Oesch, Jr. et al.
 D833,293 S * 11/2018 Lin D9/575
 D838,182 S 1/2019 Landis et al.
 D847,636 S * 5/2019 Harris D9/500
 D847,655 S * 5/2019 Lee D9/560
 D873,141 S * 1/2020 Wiebelitz D9/516
 D889,975 S * 7/2020 Cartis D9/560
 D893,305 S * 8/2020 Cartis D9/560
 D893,306 S * 8/2020 Cartis D9/560
 D893,307 S * 8/2020 Cartis D9/560
 D906,817 S * 1/2021 Abercrombie D9/500

FOREIGN PATENT DOCUMENTS

CN 304183112 6/2017
 CN 304248438 8/2017
 CN 304304842 10/2017
 CN 304448551 1/2018
 CN 305279588 7/2019
 CN 305279590 7/2019
 EM 000854666-0001 1/2008
 EM 001095350-0003 2/2009
 EM 001133052-0003 4/2009
 EM 001216568-0019 5/2010
 EM 001817024-0003 2/2011
 EM 002093708-0006 8/2012
 GB 4005313 11/2007
 GB 4010479 7/2009

* cited by examiner

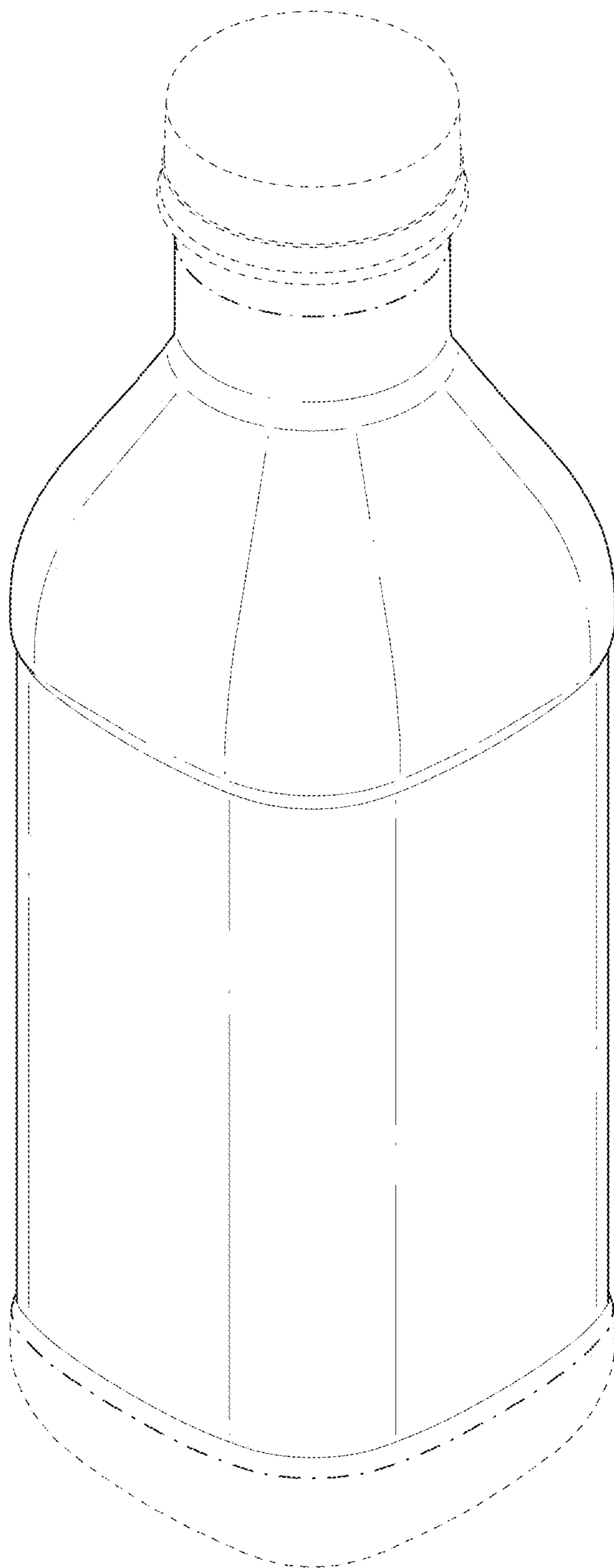

FIG. 1

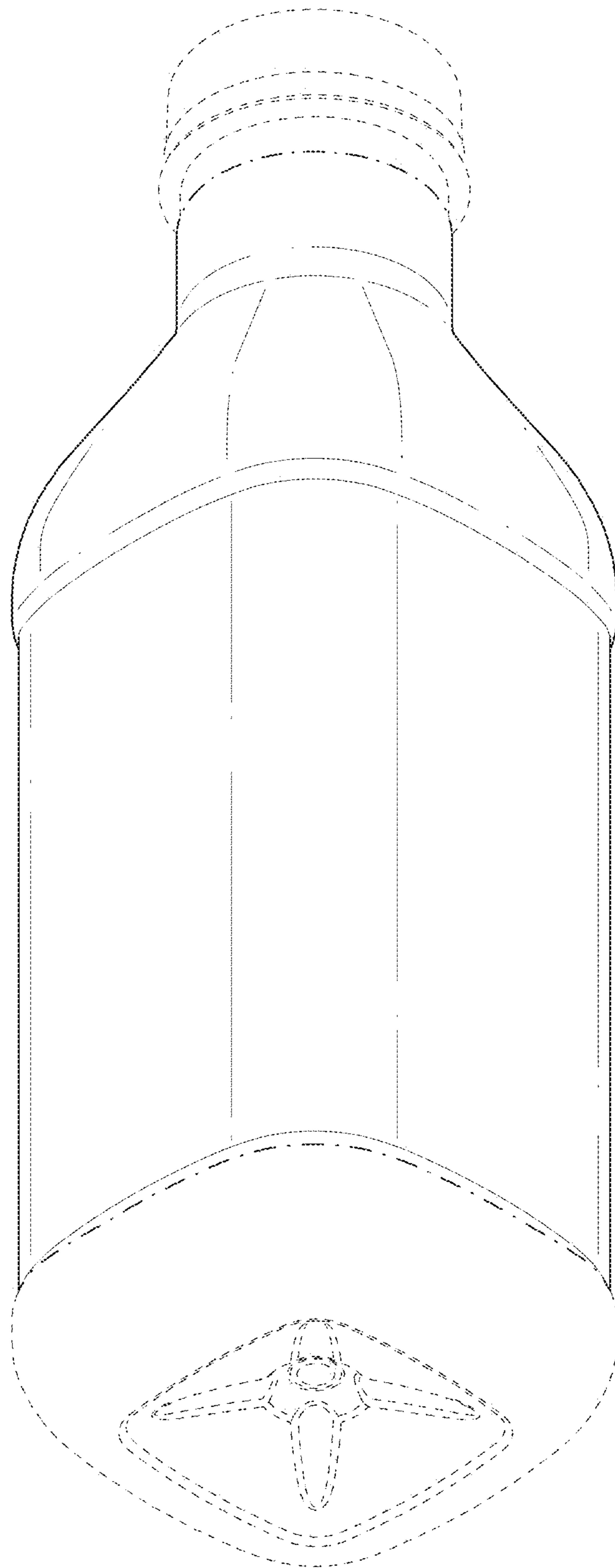

FIG. 2

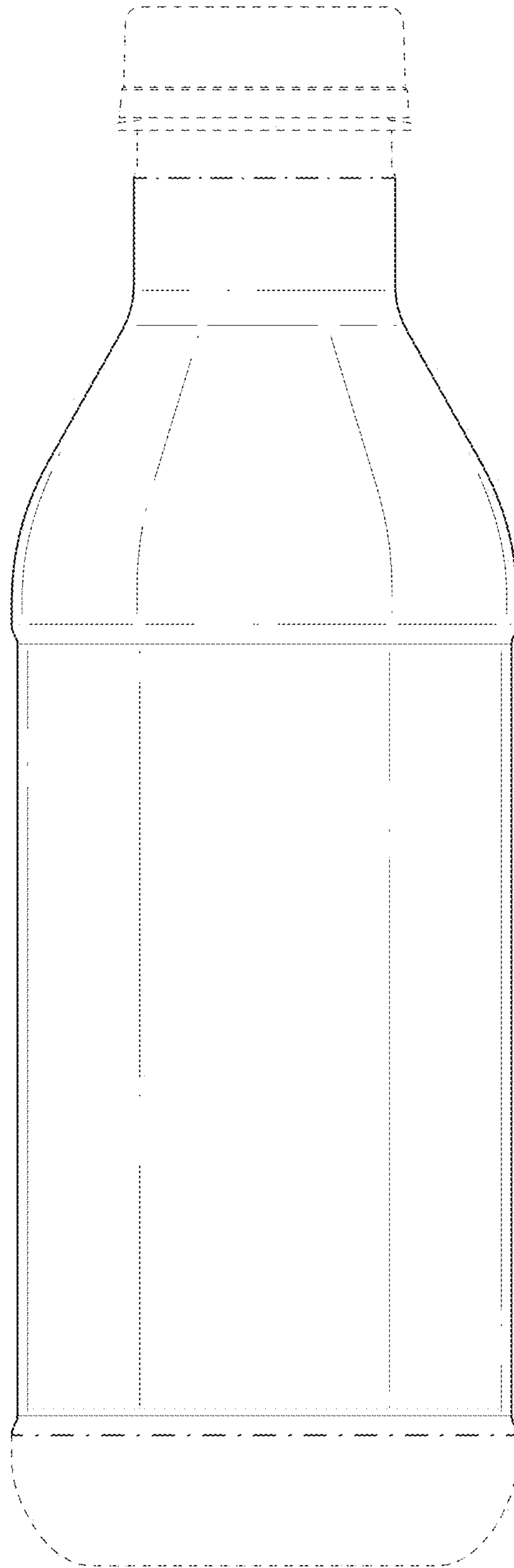

FIG. 3

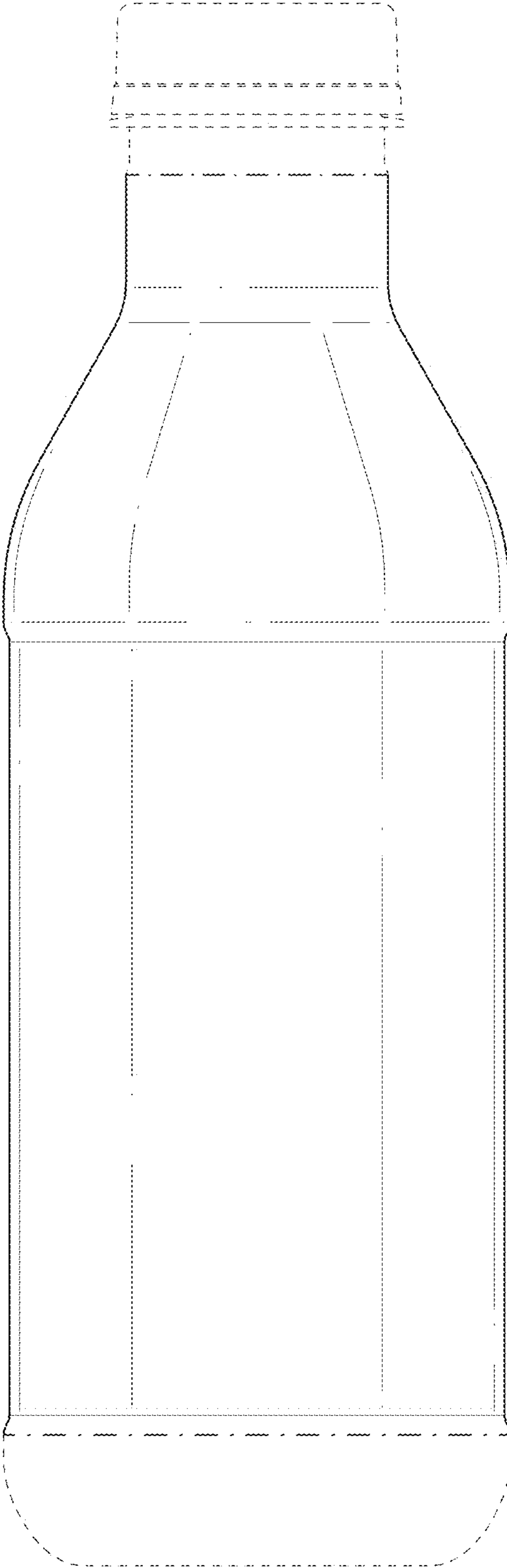

FIG. 4

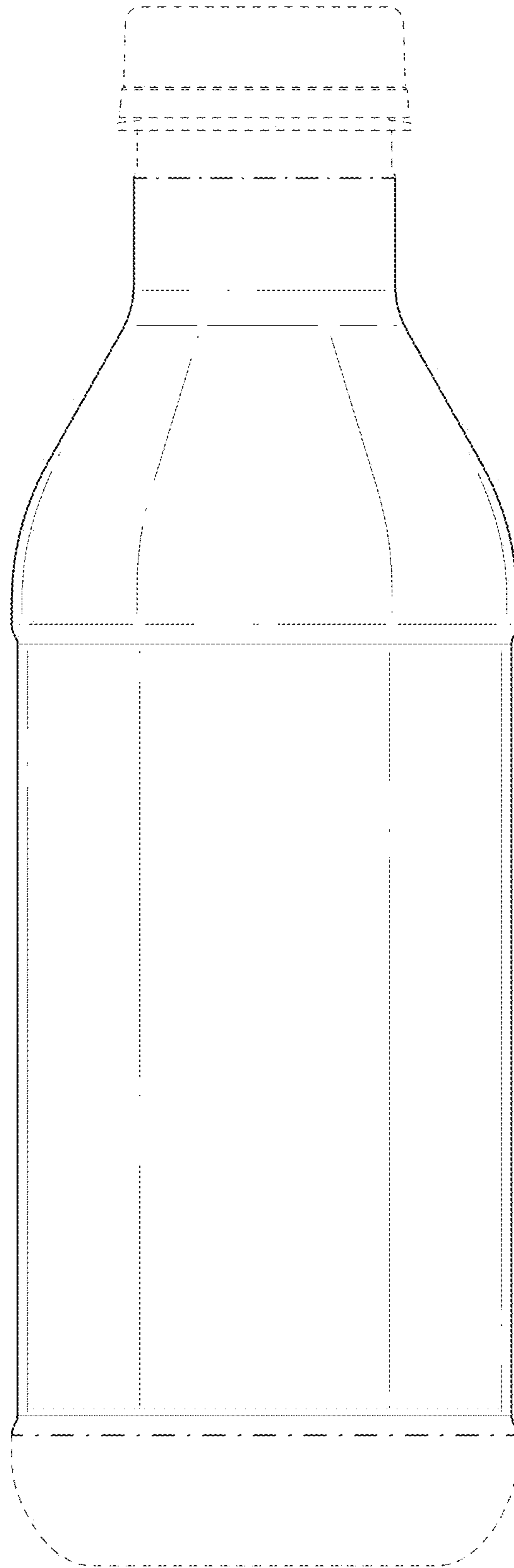

FIG. 5

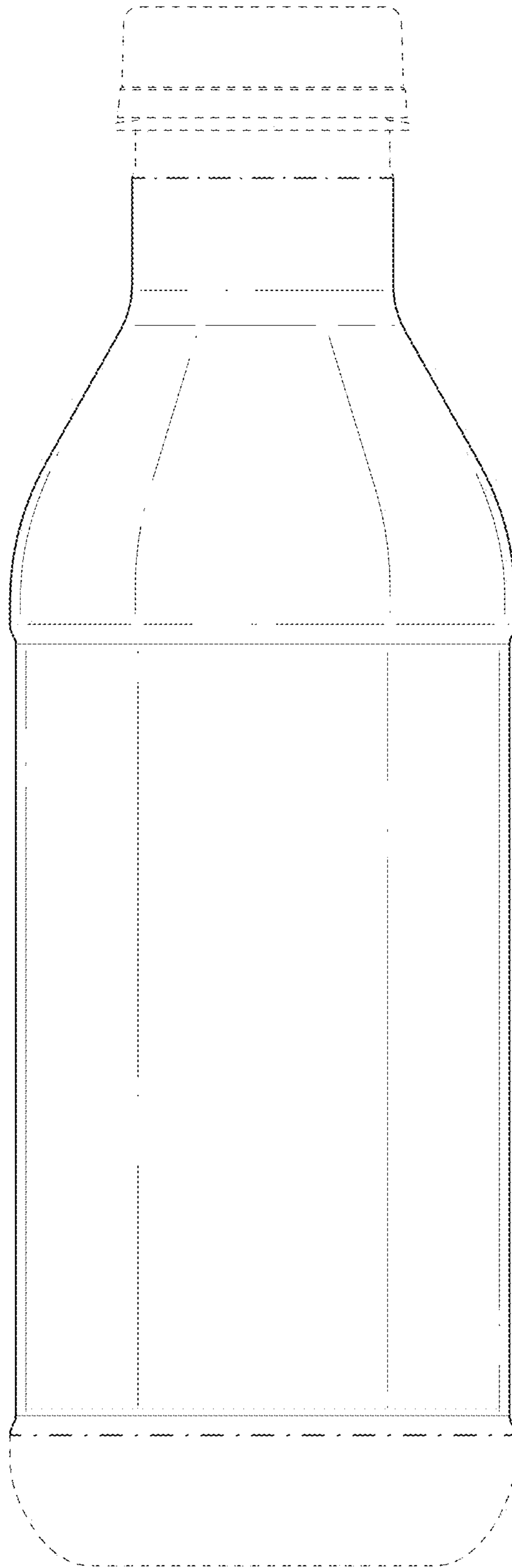

FIG. 6

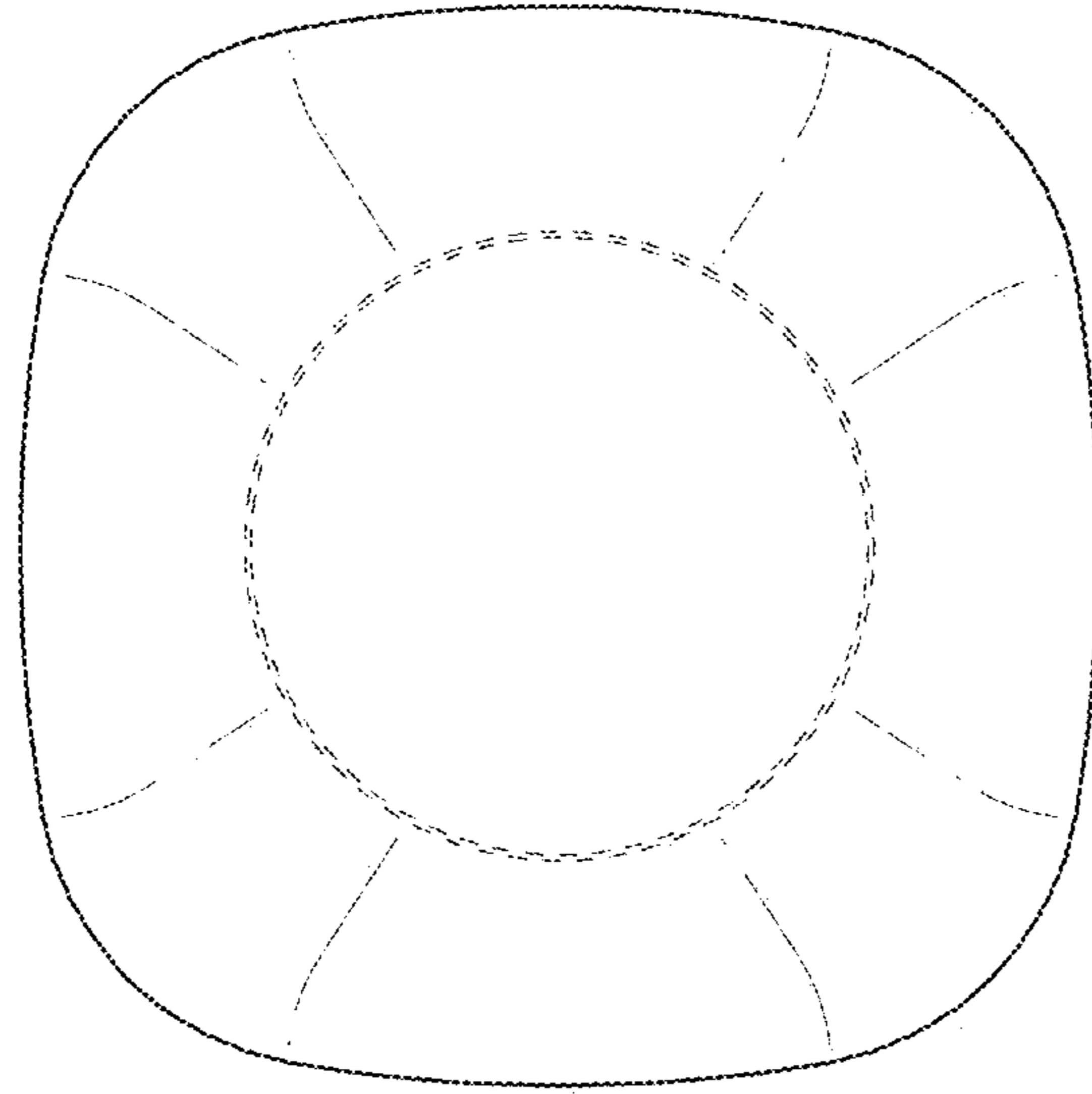

FIG. 7

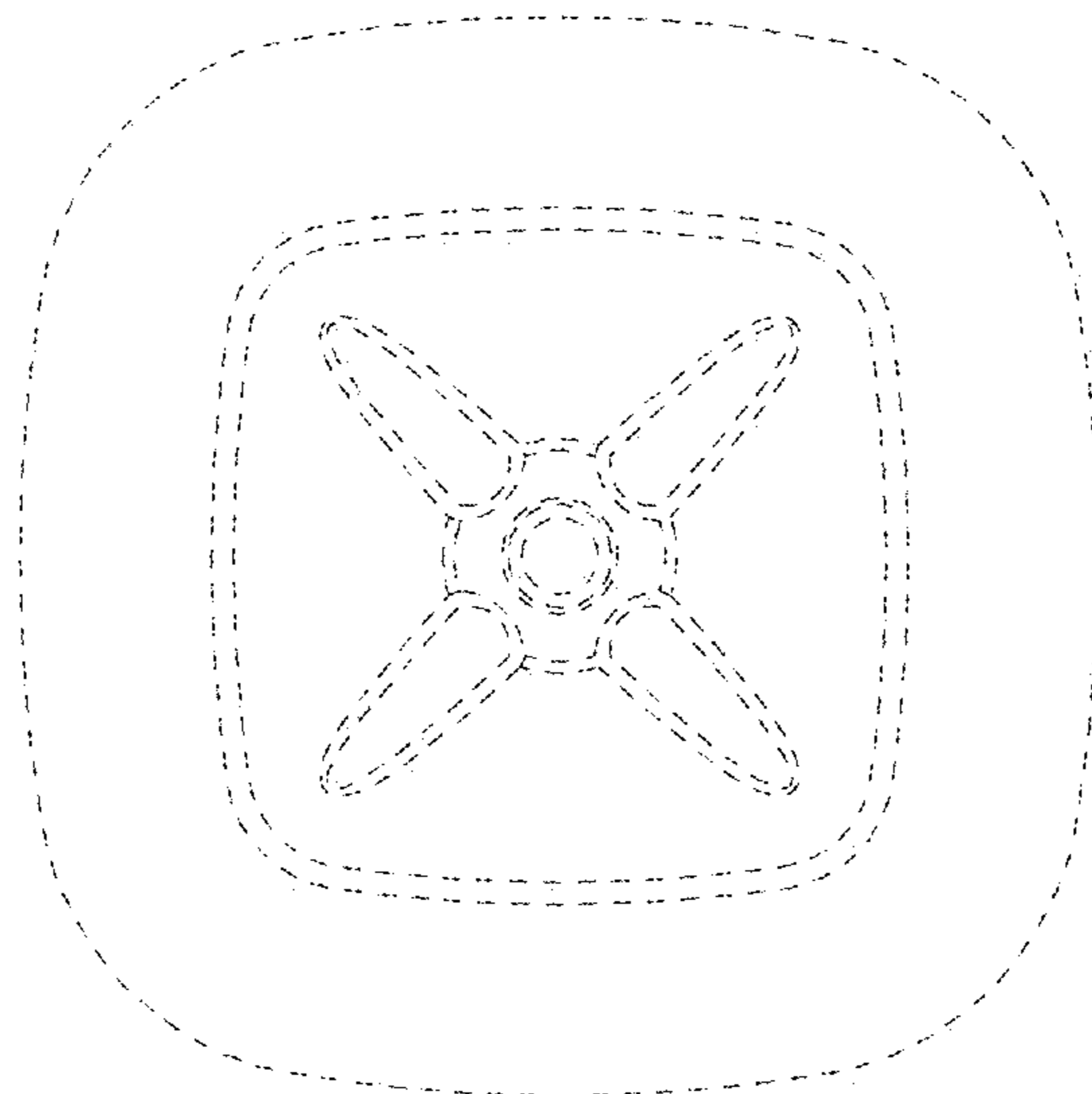

FIG. 8