



US00D932289S

(12) **United States Design Patent** (10) **Patent No.:** **US D932,289 S**  
**Tortorella, Jr.** (45) **Date of Patent:** **\*\* Oct. 5, 2021**

(54) **UNIVERSAL WALL MOUNT**

(71) Applicant: **Frank Joseph Tortorella, Jr.**, Park Ridge, IL (US)

(72) Inventor: **Frank Joseph Tortorella, Jr.**, Park Ridge, IL (US)

(\*\*) Term: **15 Years**

(21) Appl. No.: **29/647,129**

(22) Filed: **May 9, 2018**

(51) **LOC (13) Cl.** ..... **08-05**

(52) **U.S. Cl.**  
USPC ..... **D8/373**

(58) **Field of Classification Search**  
USPC ..... D6/323, 553, 512, 403, 556; D8/363, D8/380, 372, 371

(Continued)

(56) **References Cited**

**U.S. PATENT DOCUMENTS**

D321,985 S	*	12/1991	Ward	.....	D3/282
D343,063 S	*	1/1994	Chen	.....	D3/282
D343,731 S	*	2/1994	Tsumita	.....	D3/282
D364,957 S	*	12/1995	Turbowitz	.....	D3/276
D390,358 S	*	2/1998	Calmeise	.....	D3/282
D406,192 S	*	3/1999	Schurman	.....	D3/282

(Continued)

**OTHER PUBLICATIONS**

Homedepot.com, TAFCO Products 17—CompartmentWall Mount Pro-GO Divided Small Pars Organizer, Nov. 19, 2018, [https://www.homedepot.com/p/TAFCO-Products-17-Compartment-Wall-Mount-Pro-Go-Divided-Small-Parts-Organizer-Blue-WMDL17BL/307648022?MERCH=REC-\\_-PIPHorizontal2\\_rr\\_-305211384-\\_-307648022-\\_-N](https://www.homedepot.com/p/TAFCO-Products-17-Compartment-Wall-Mount-Pro-Go-Divided-Small-Parts-Organizer-Blue-WMDL17BL/307648022?MERCH=REC-_-PIPHorizontal2_rr_-305211384-_-307648022-_-N) (Year: 2018).\*

*Primary Examiner* — Eliza Z Bennett-Hattan

(57) **CLAIM**

The ornamental design for a universal wall mount, as shown and described.

**DESCRIPTION**

FIG. 1 is a top right front perspective view of a design for a universal wall mount in a first position;  
FIG. 2 is a front view of the design for the universal wall mount in the first position;  
FIG. 3 is a rear view of the design for the universal wall mount in the first position;  
FIG. 4 is a left side view of the design for the universal wall mount in the first position;  
FIG. 5 is a right side view of the design for the universal wall mount in the first position;  
FIG. 6 is a top view of the design for the universal wall mount in the first position;  
FIG. 7 is a bottom view of the design for the universal wall mount in the first position;  
FIG. 8 is a top right front perspective view of the design for the universal wall mount in the first position in relation to an example first tool organizer;  
FIG. 9 is a front view of the design for the universal wall mount in the first position in relation to the example first tool organizer;  
FIG. 10 is a rear view of the design for the universal wall mount in the first position in relation to the example first tool organizer;  
FIG. 11 is a left side view of the design for the universal wall mount in the first position in relation to the example first tool organizer;  
FIG. 12 is a right side view of the design for the universal wall mount in the first position in relation to the example first tool organizer;  
FIG. 13 is a top view of the design for the universal wall mount in the first position in relation to the example first tool organizer;

(Continued)

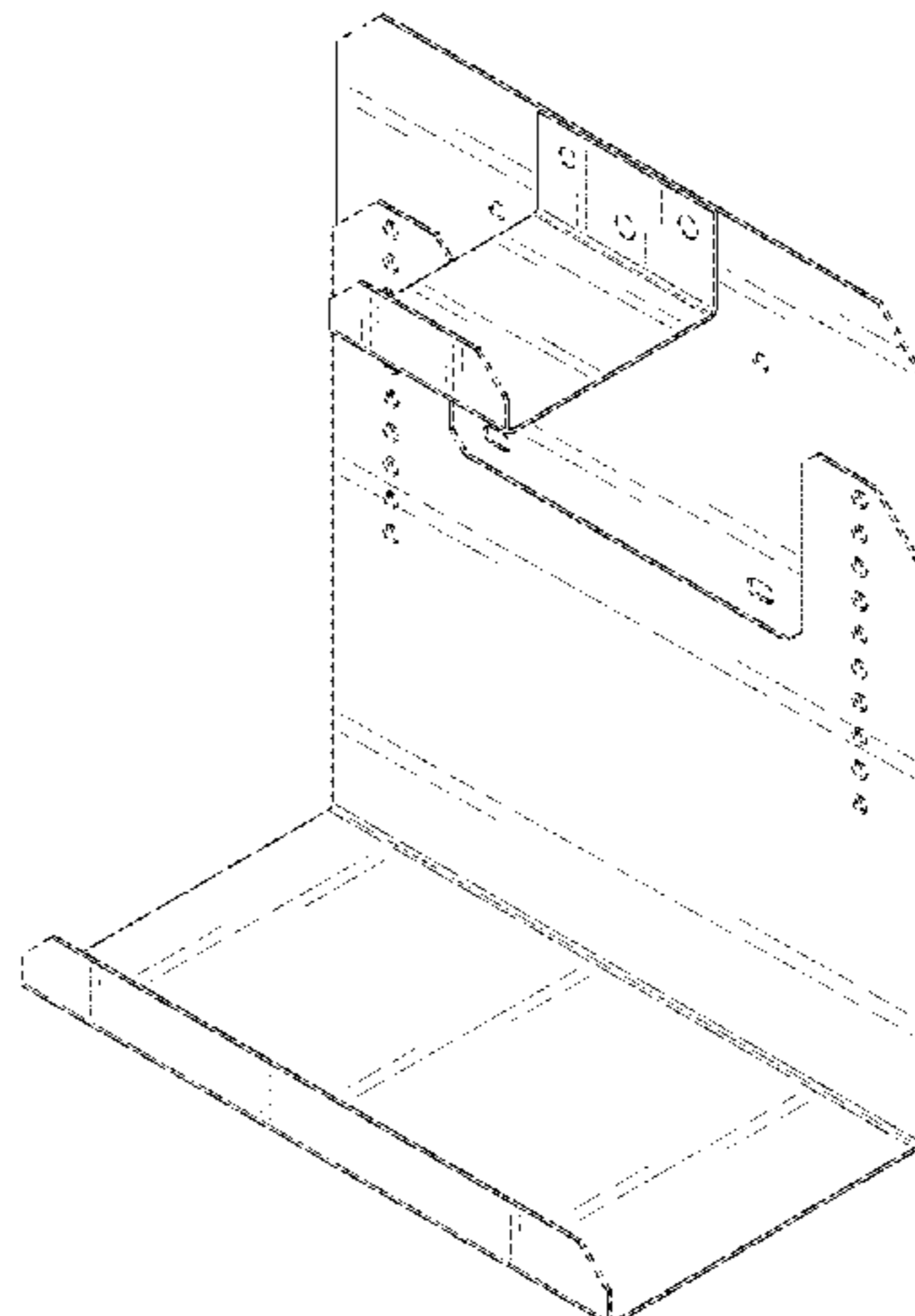

FIG. 14 is a bottom view of the design for the universal wall mount in the first position in relation to the example first tool organizer;

FIG. 15 is a top right front perspective view of the design for the universal wall mount in a second position in relation to an example second tool organizer;

FIG. 16 is a front view of the design for the universal wall mount in the second position in relation to the example second tool organizer;

FIG. 17 is a rear view of the design for the universal wall mount in the second position in relation to the example second tool organizer;

FIG. 18 is a left side view of the design for the universal wall mount in the second position in relation to the example second tool organizer;

FIG. 19 is a right side view of the design for the universal wall mount in the second position in relation to the example second tool organizer;

FIG. 20 is a top view of the design for the universal wall mount in the second position in relation to the example second tool organizer; and,

FIG. 21 is a bottom view of the design for the universal wall mount in the second position in relation to the example second tool organizer.

The features shown in broken lines depict environmental structure only and form no part of the claimed design.

**1 Claim, 21 Drawing Sheets**

(58) **Field of Classification Search**

CPC ..... F16M 13/02; F16M 13/022

See application file for complete search history.

(56) **References Cited**

U.S. PATENT DOCUMENTS

D413,440	S	*	9/1999	Schurman	.....	D3/276
D477,913	S	*	8/2003	Fang	.....	D3/282
D478,209	S	*	8/2003	Chen	.....	D3/282
D530,914	S	*	10/2006	Jansson	.....	D3/282
D563,669	S	*	3/2008	Bosak	.....	D3/282
D568,607	S	*	5/2008	Hsu	.....	D3/282
D572,479	S	*	7/2008	Buck	.....	D3/282
D600,015	S	*	9/2009	Wenchel	.....	D3/294
D601,797	S	*	10/2009	Wenchel	.....	D3/294
D608,094	S	*	1/2010	Concari	.....	D3/282
D636,996	S	*	5/2011	Kokawa	.....	D3/282
D639,058	S	*	6/2011	Chiu	.....	D3/282
D639,059	S	*	6/2011	Fraiman	.....	D3/282
D668,455	S	*	10/2012	Chang	.....	D3/282
D719,352	S	*	12/2014	Shitrit	.....	D3/282
D721,891	S	*	2/2015	Ben-Gigi	.....	D3/282
D725,388	S	*	3/2015	Cole	.....	D3/282
D738,622	S	*	9/2015	Sabbag	.....	D3/282
D785,938	S	*	5/2017	Ou	.....	D3/282
D816,334	S	*	5/2018	Brunner	.....	D3/273

\* cited by examiner

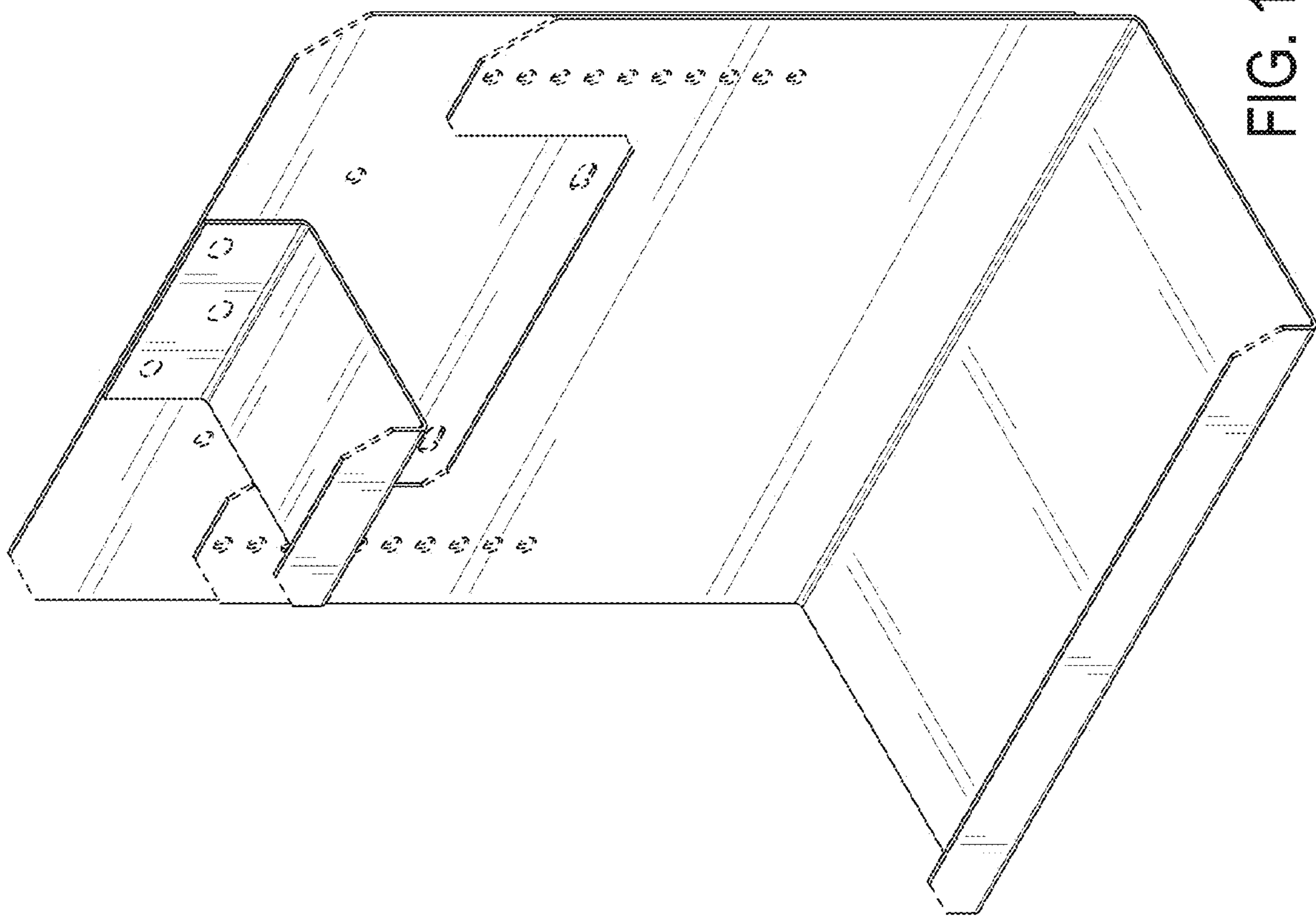

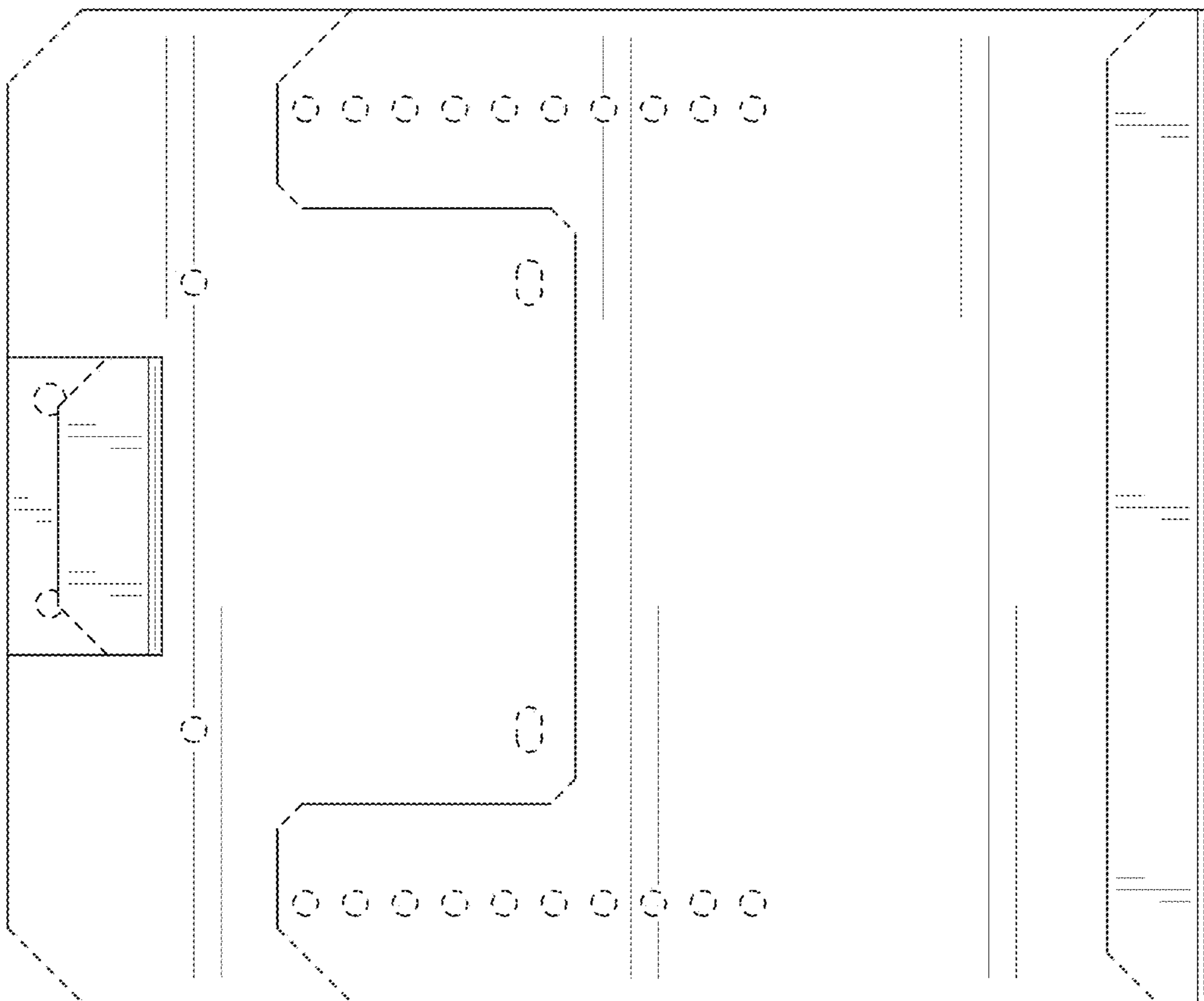

FIG. 2



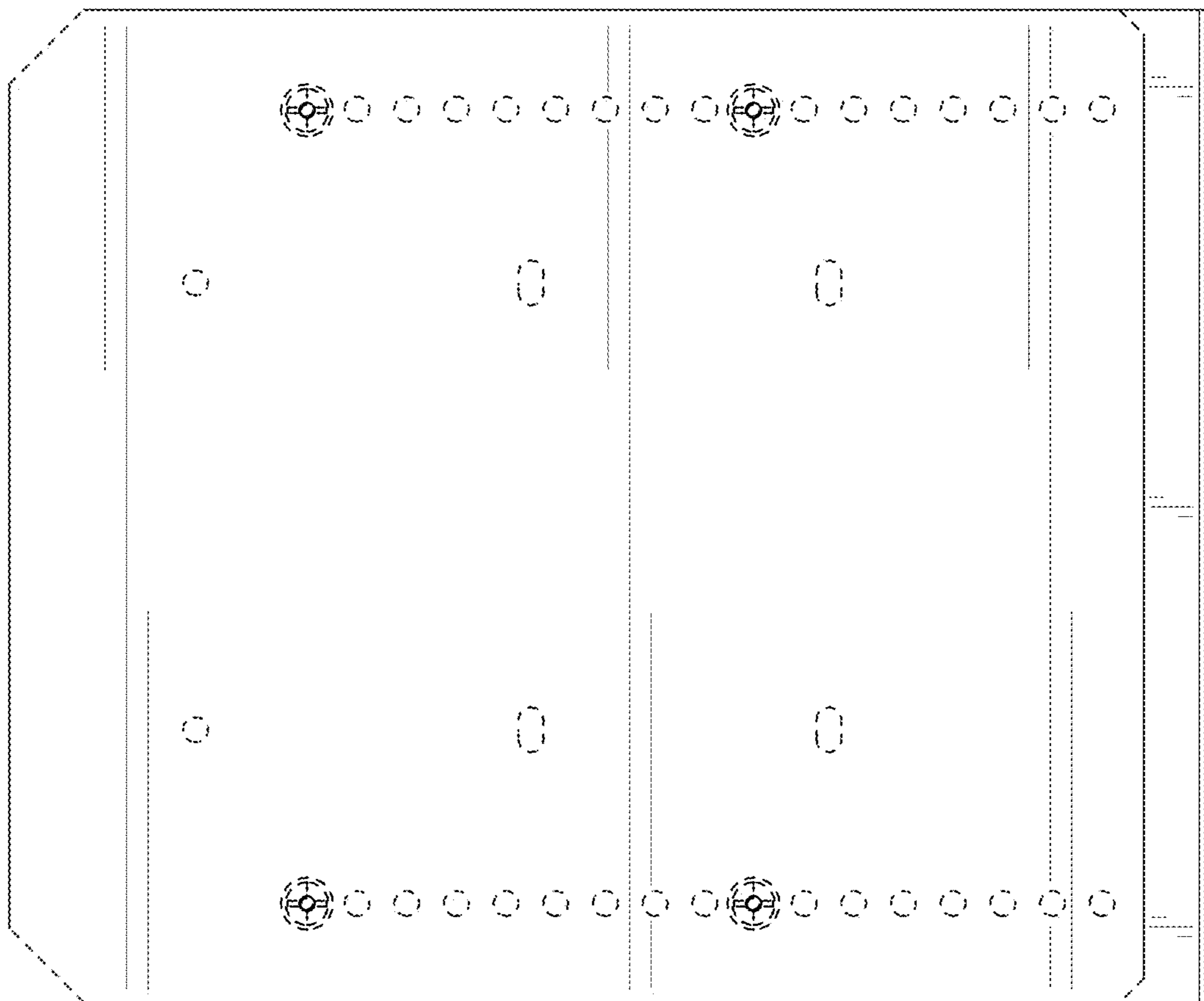

FIG. 3

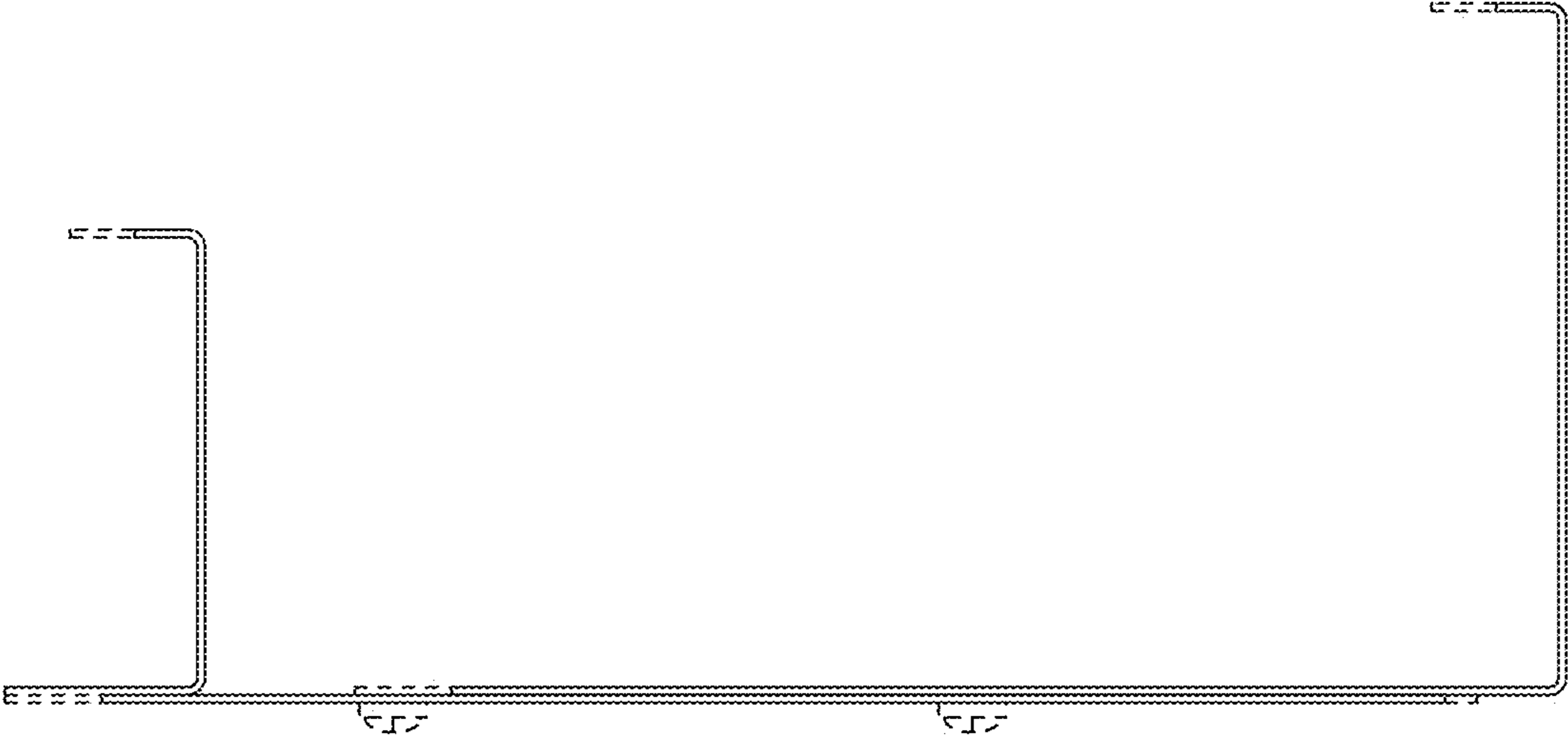

FIG. 4

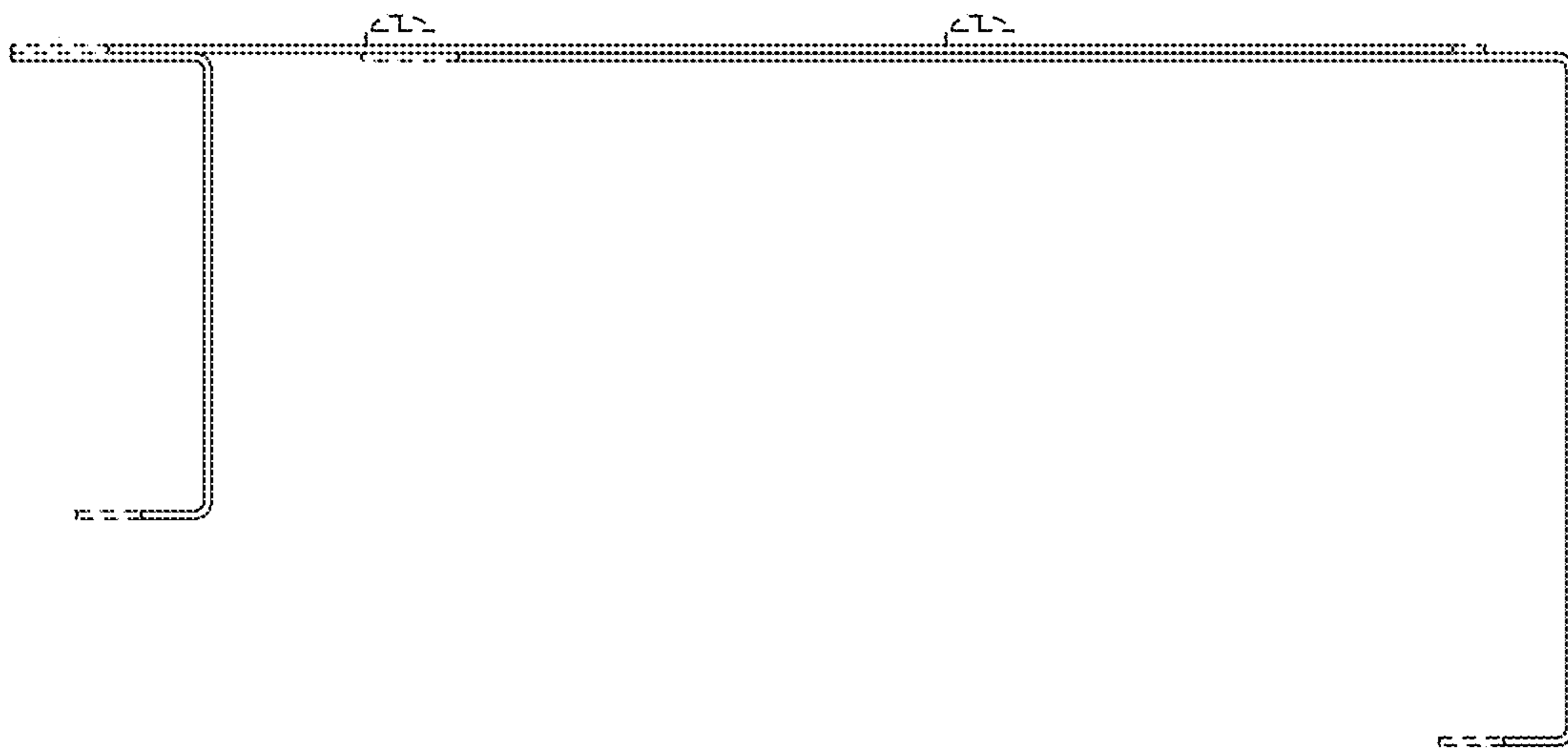

FIG. 5

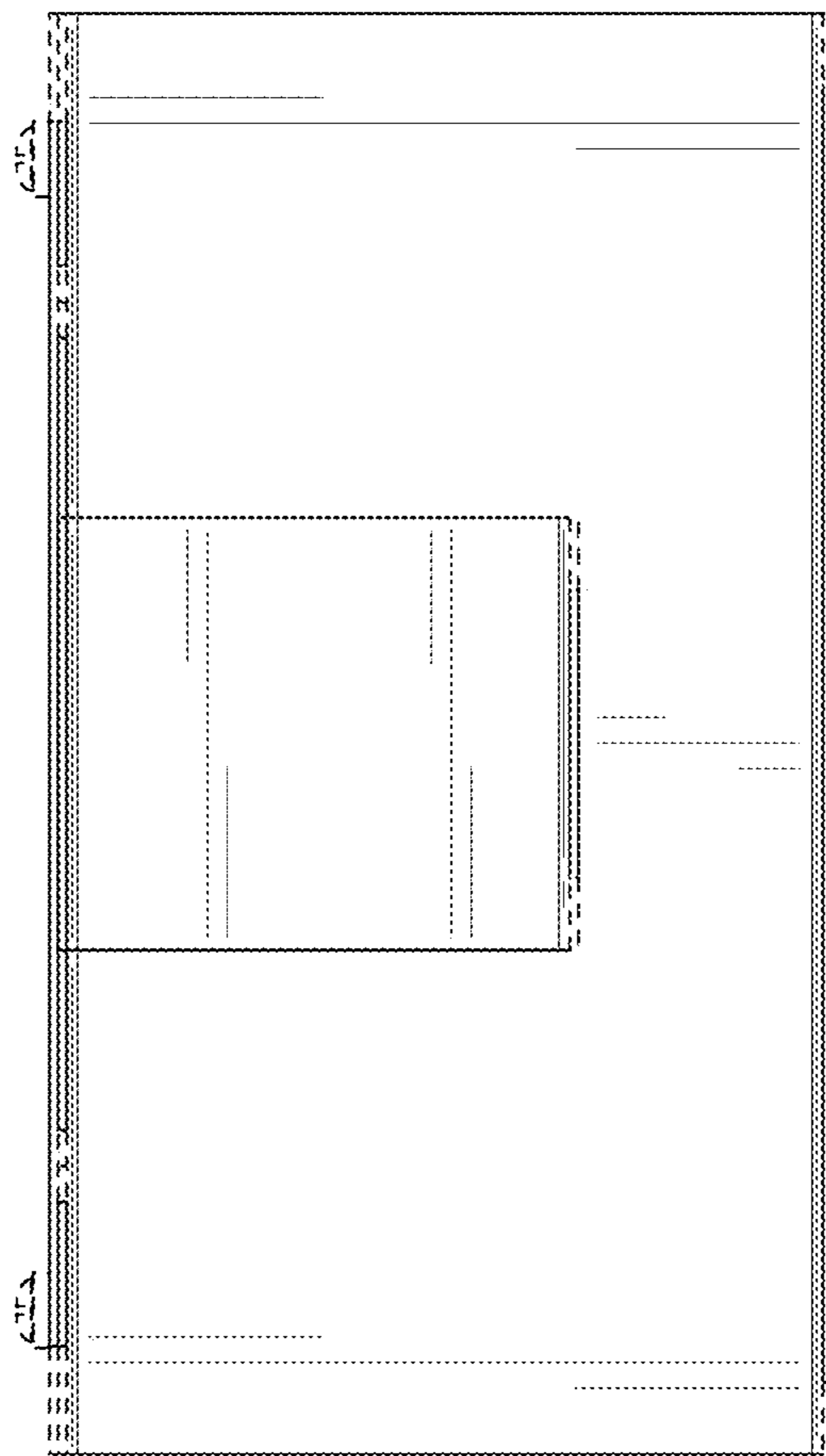

FIG. 6



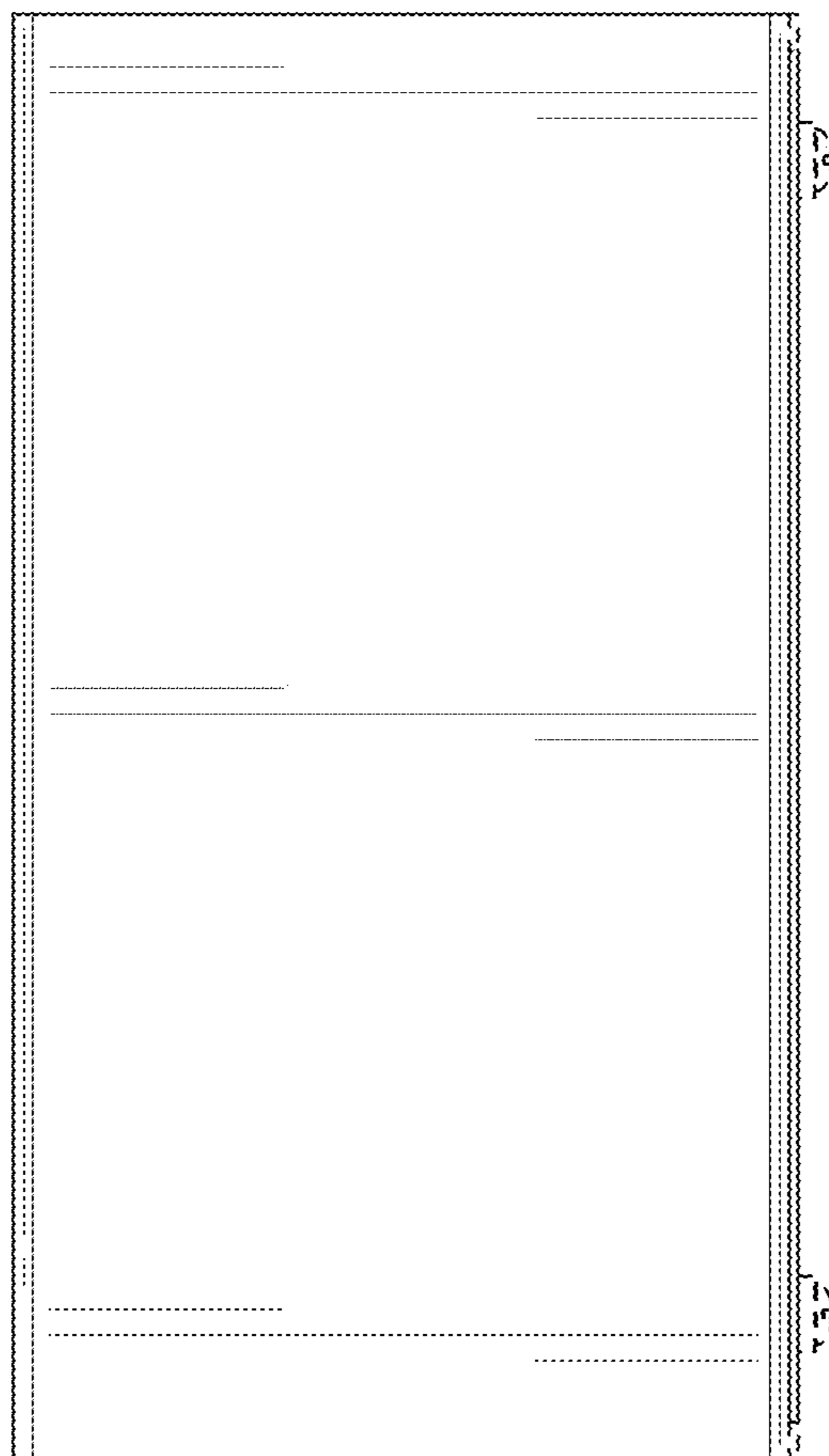

FIG. 7

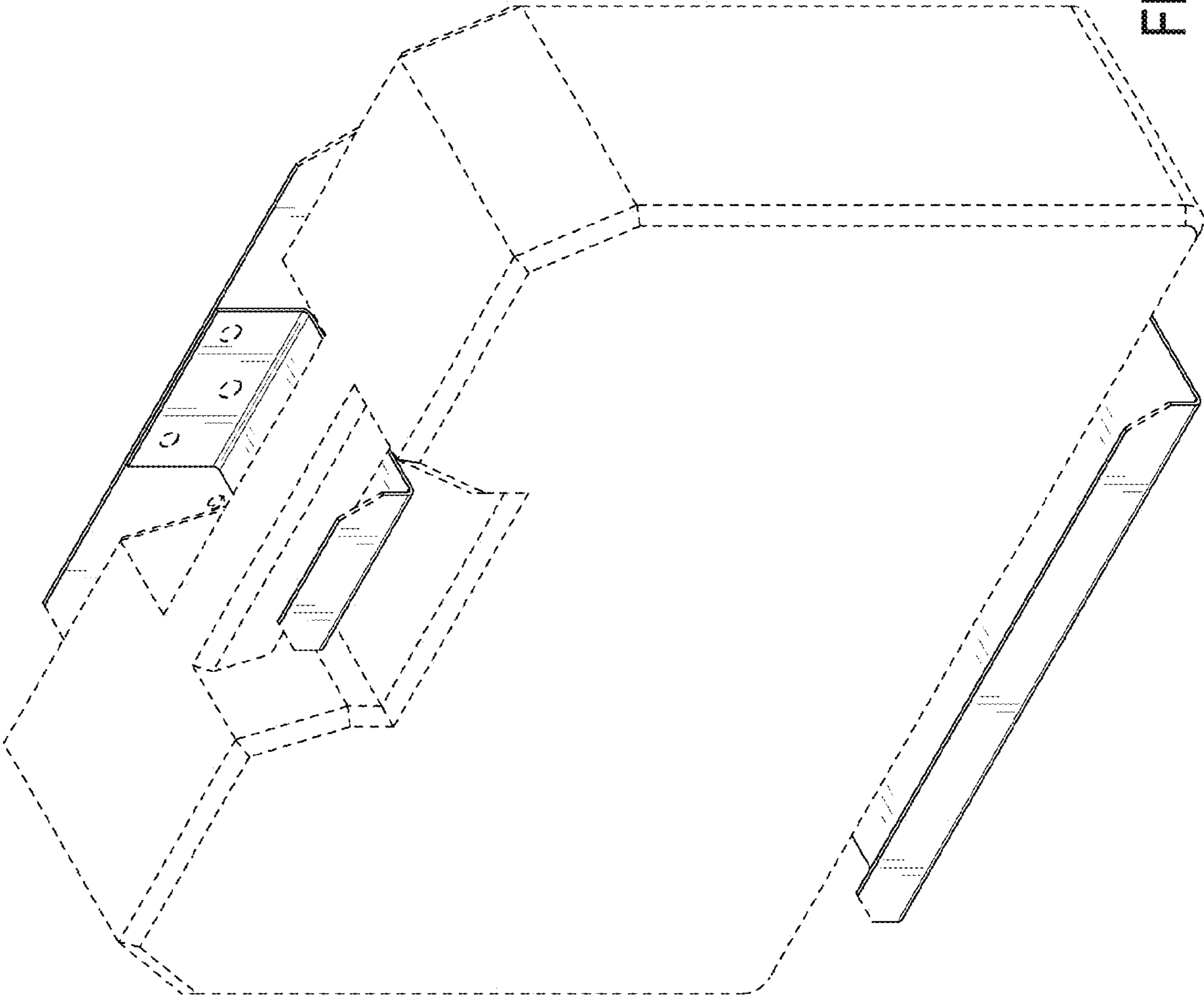

FIG. 8

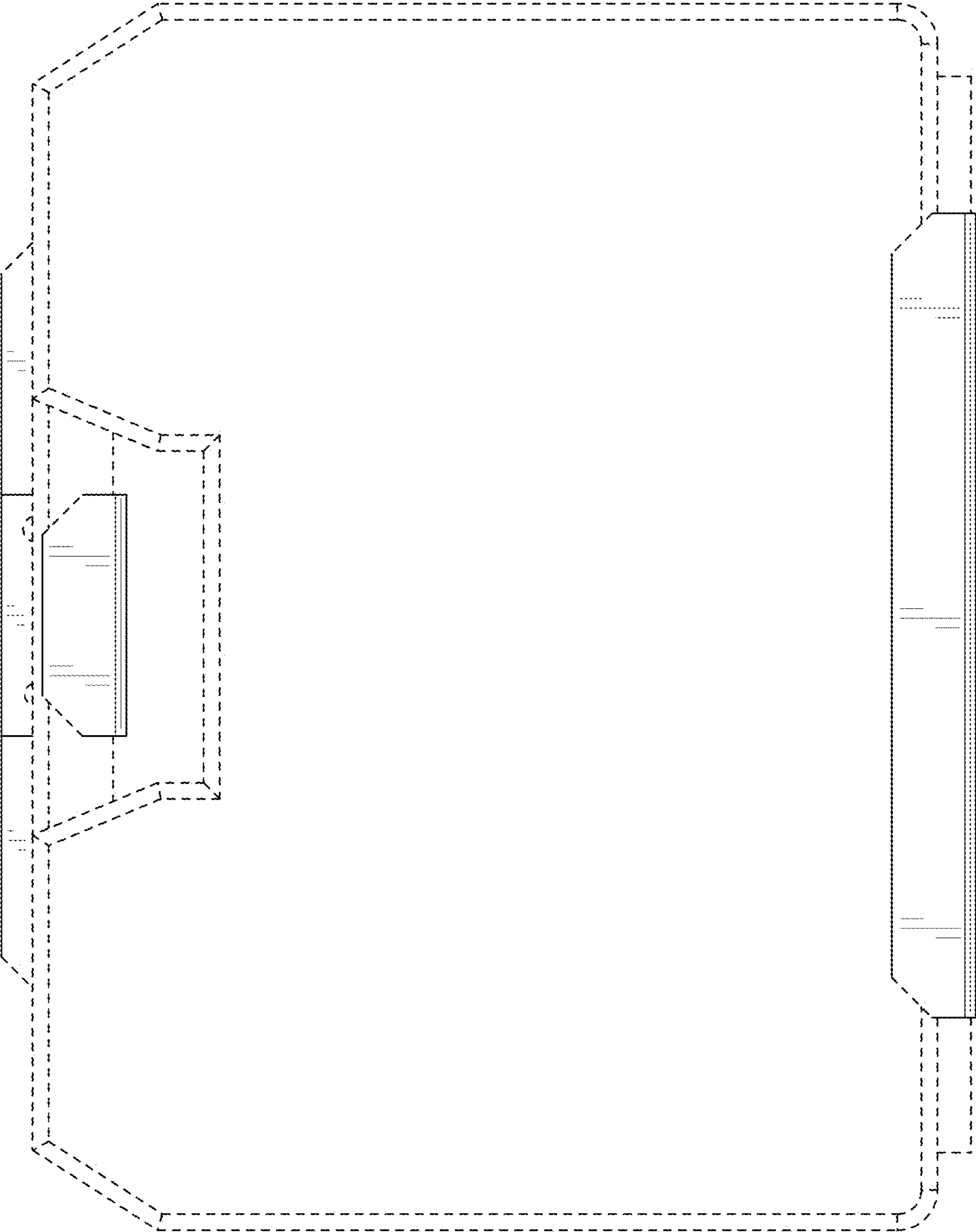

FIG. 9

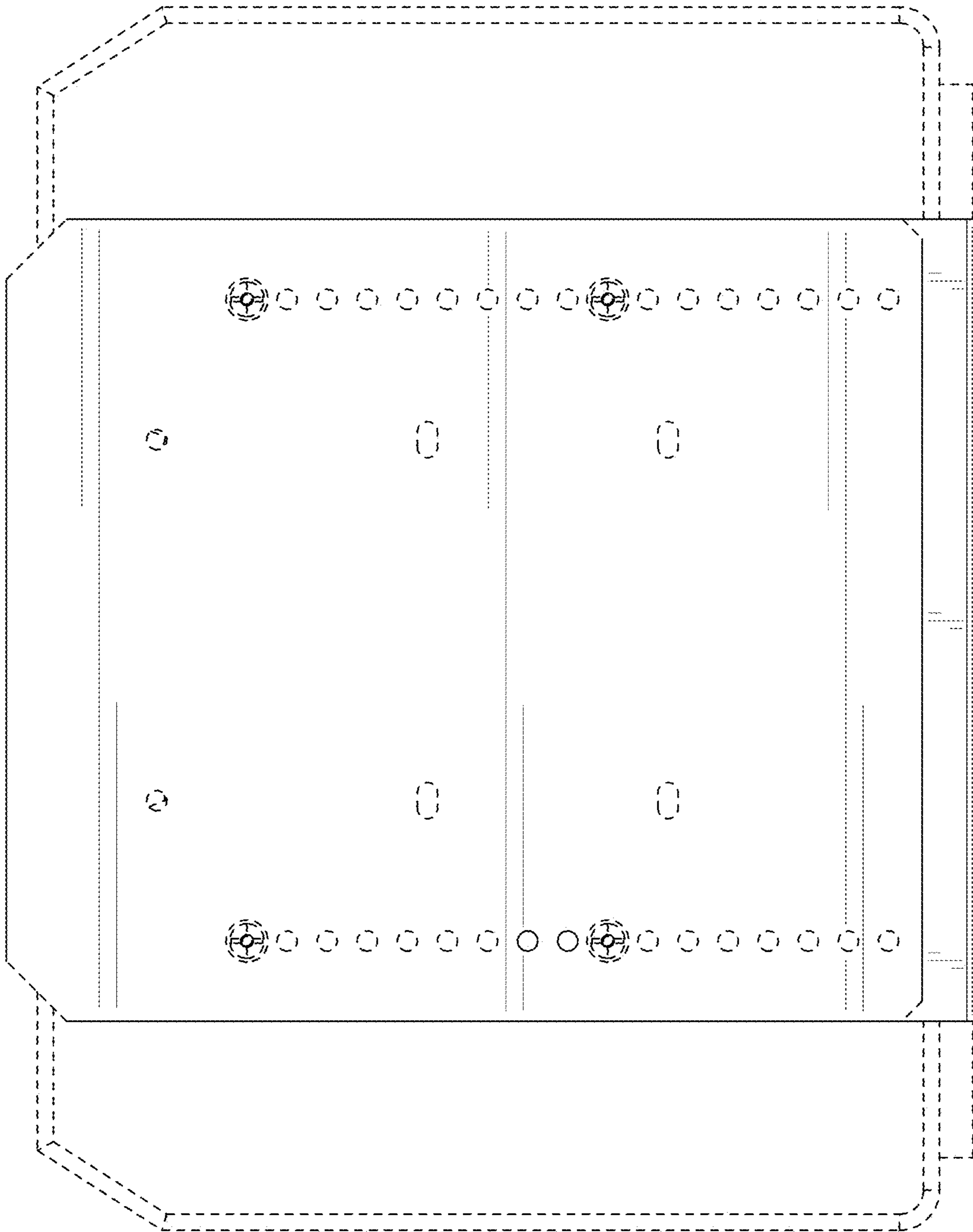

FIG. 10

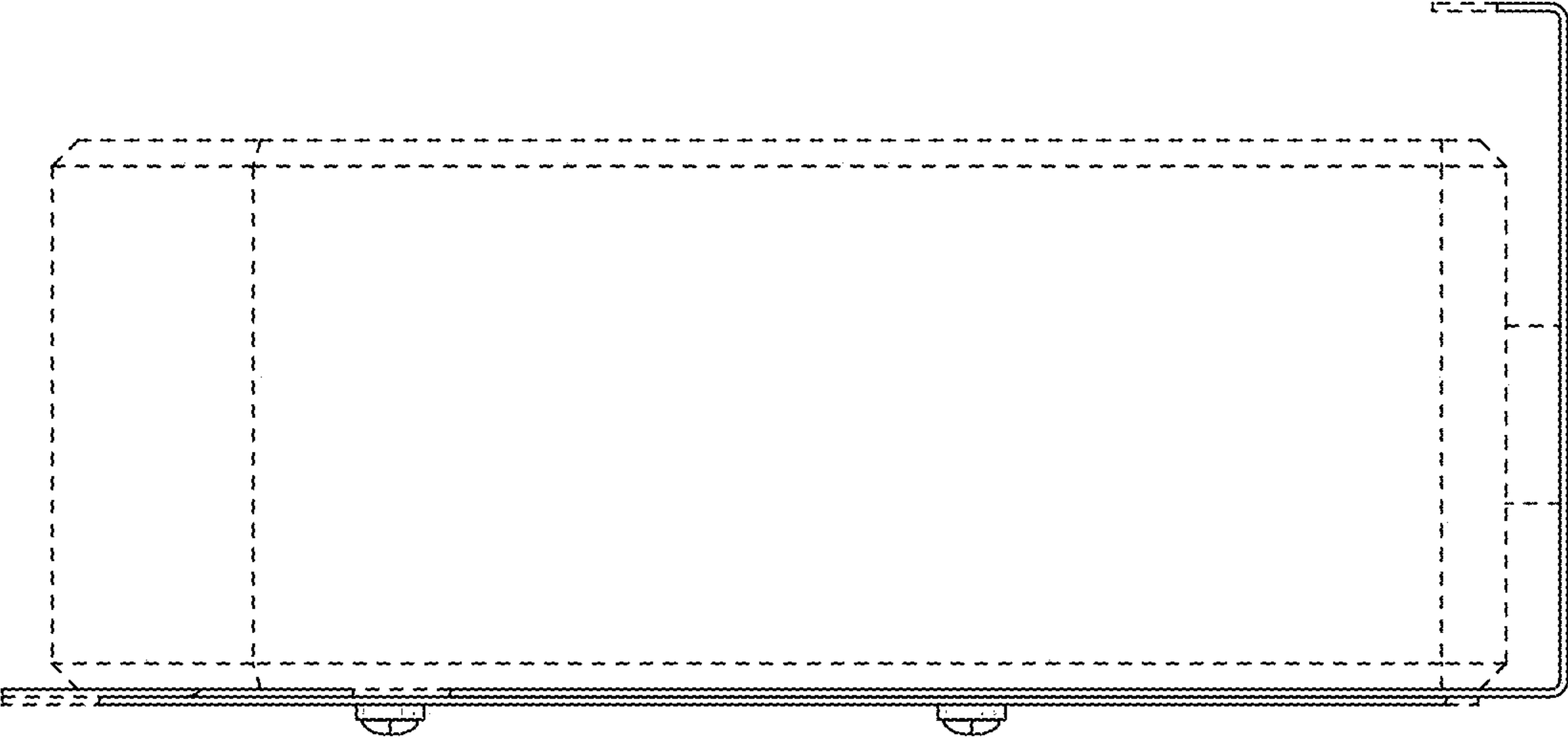

FIG. 11

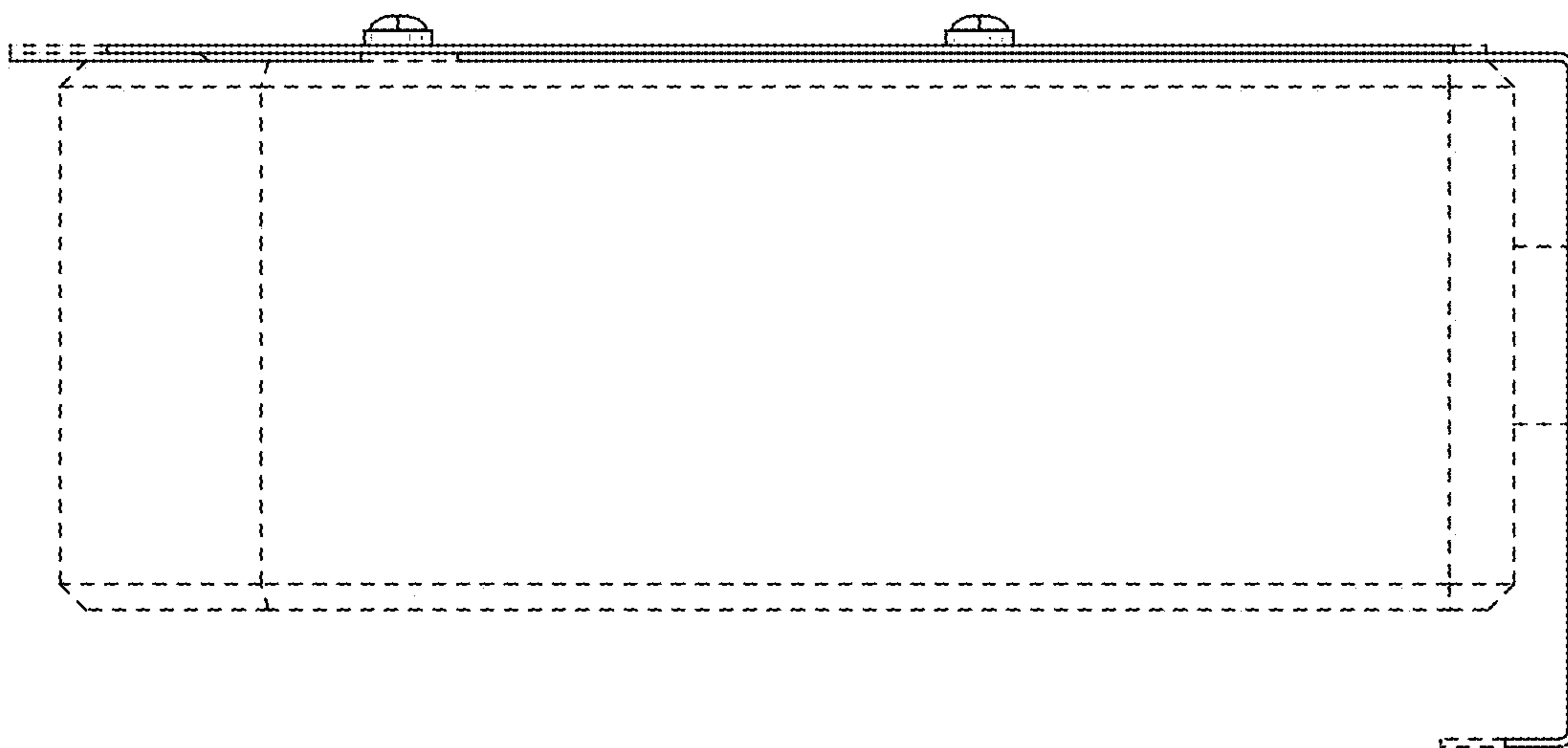

FIG. 12



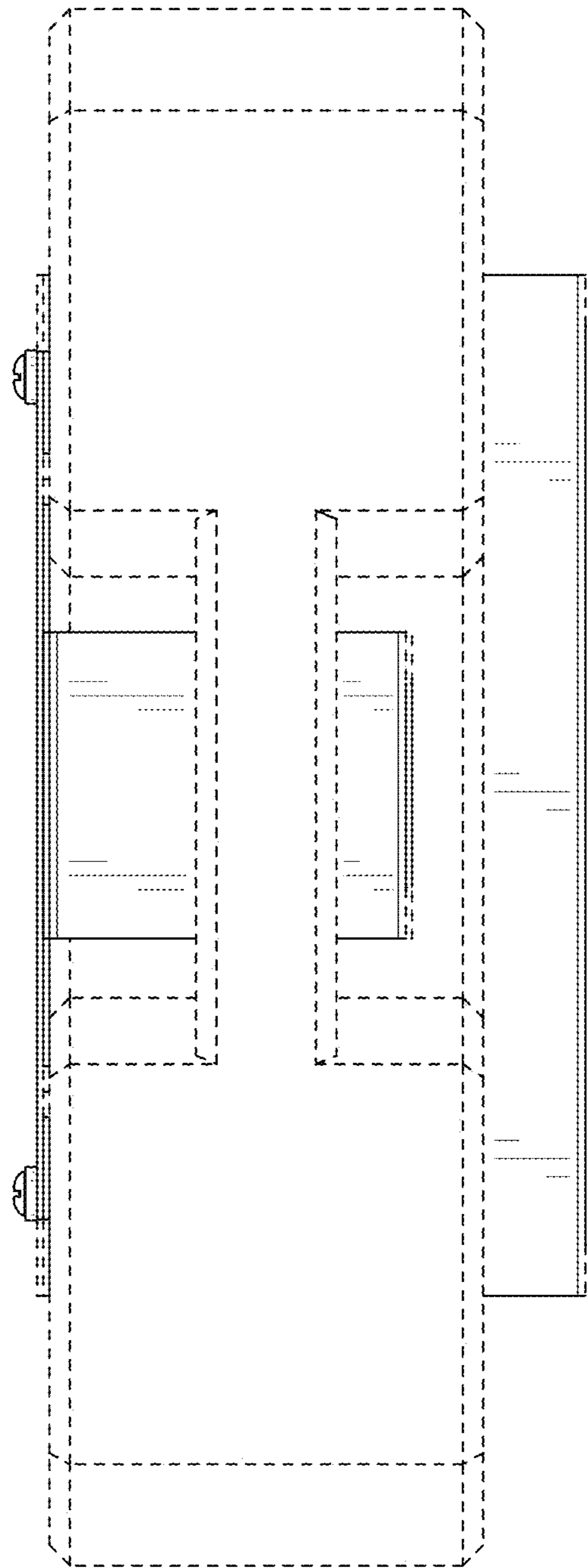

FIG. 13

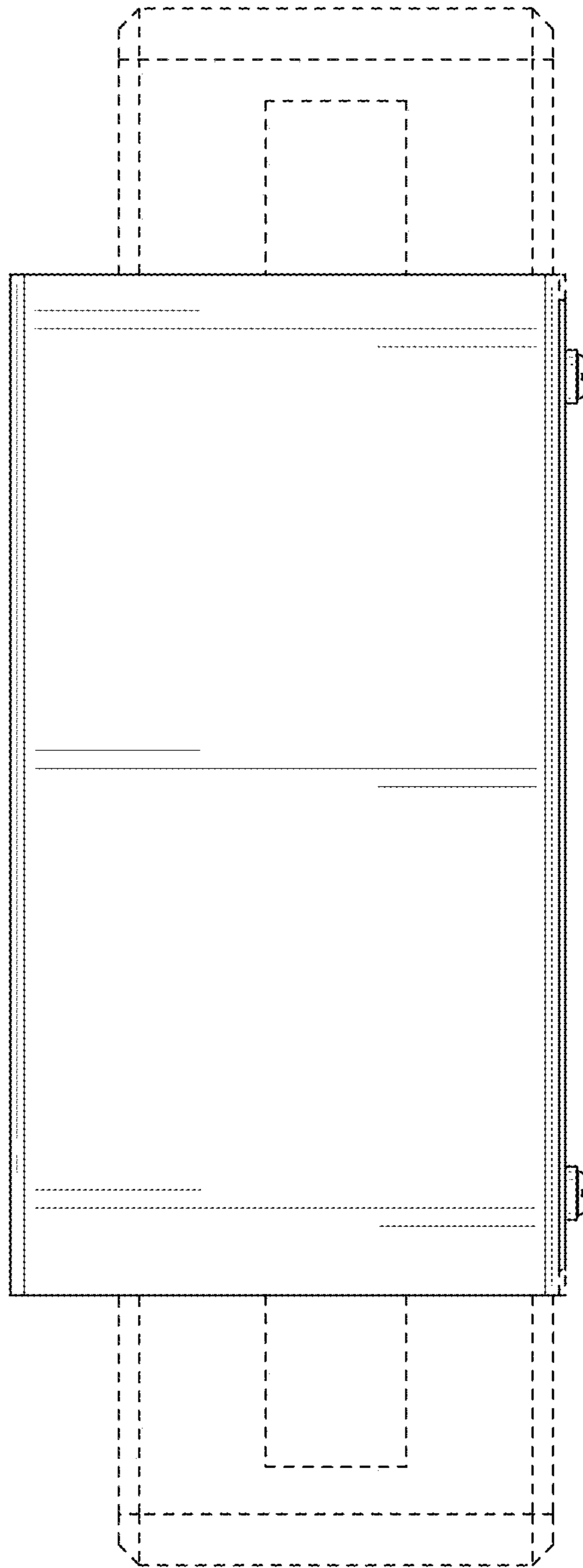

FIG. 14

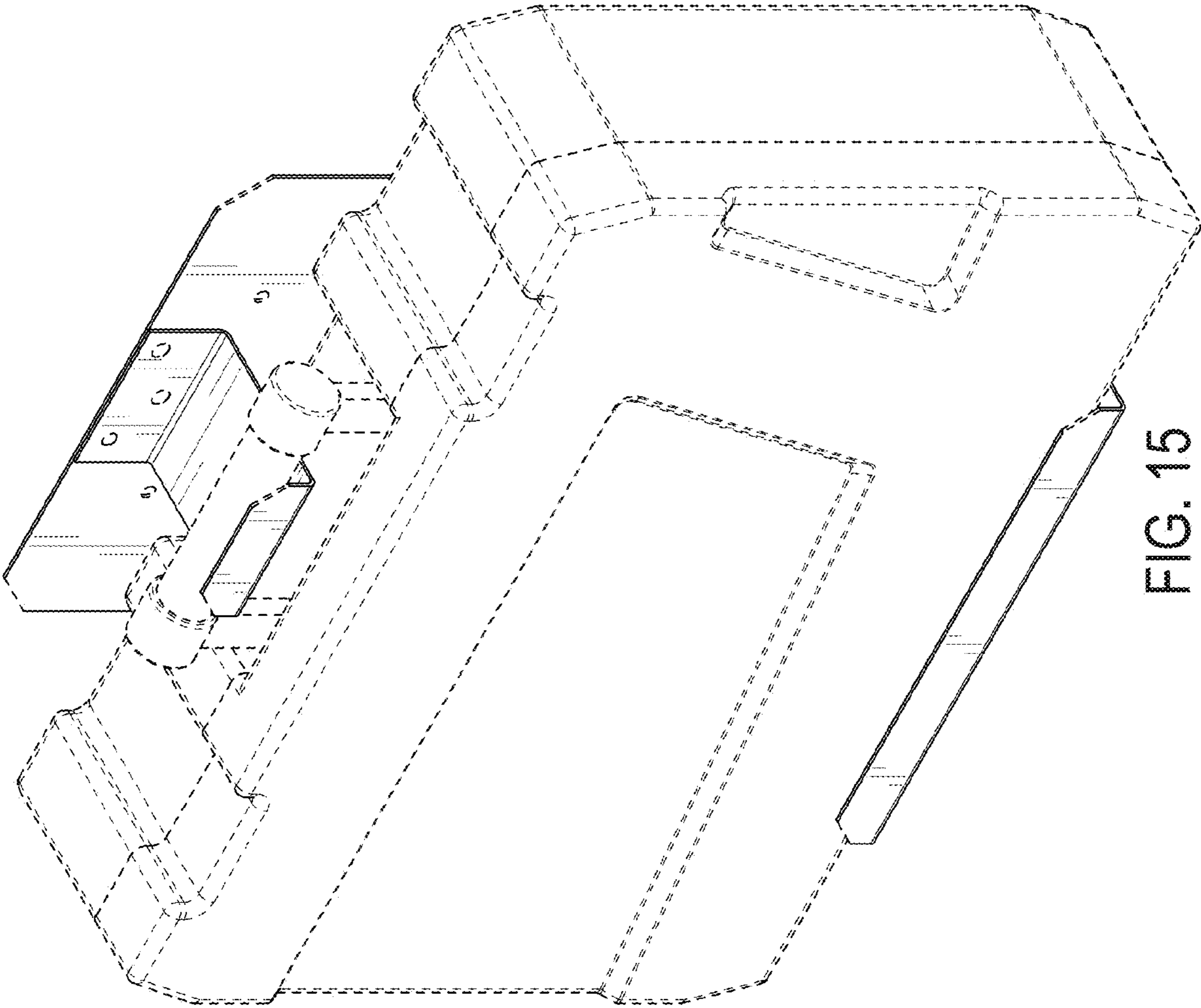

FIG. 15

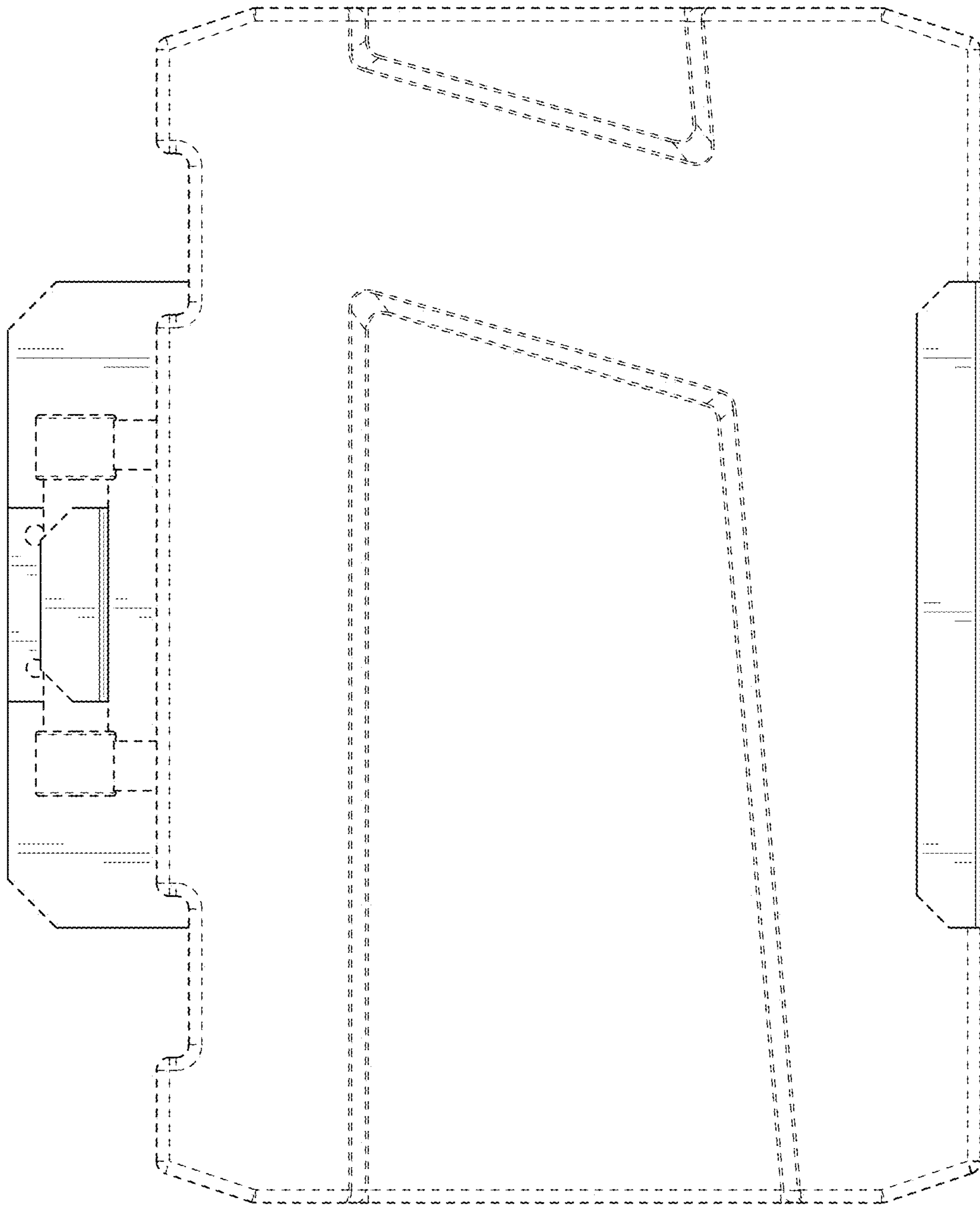

FIG. 16

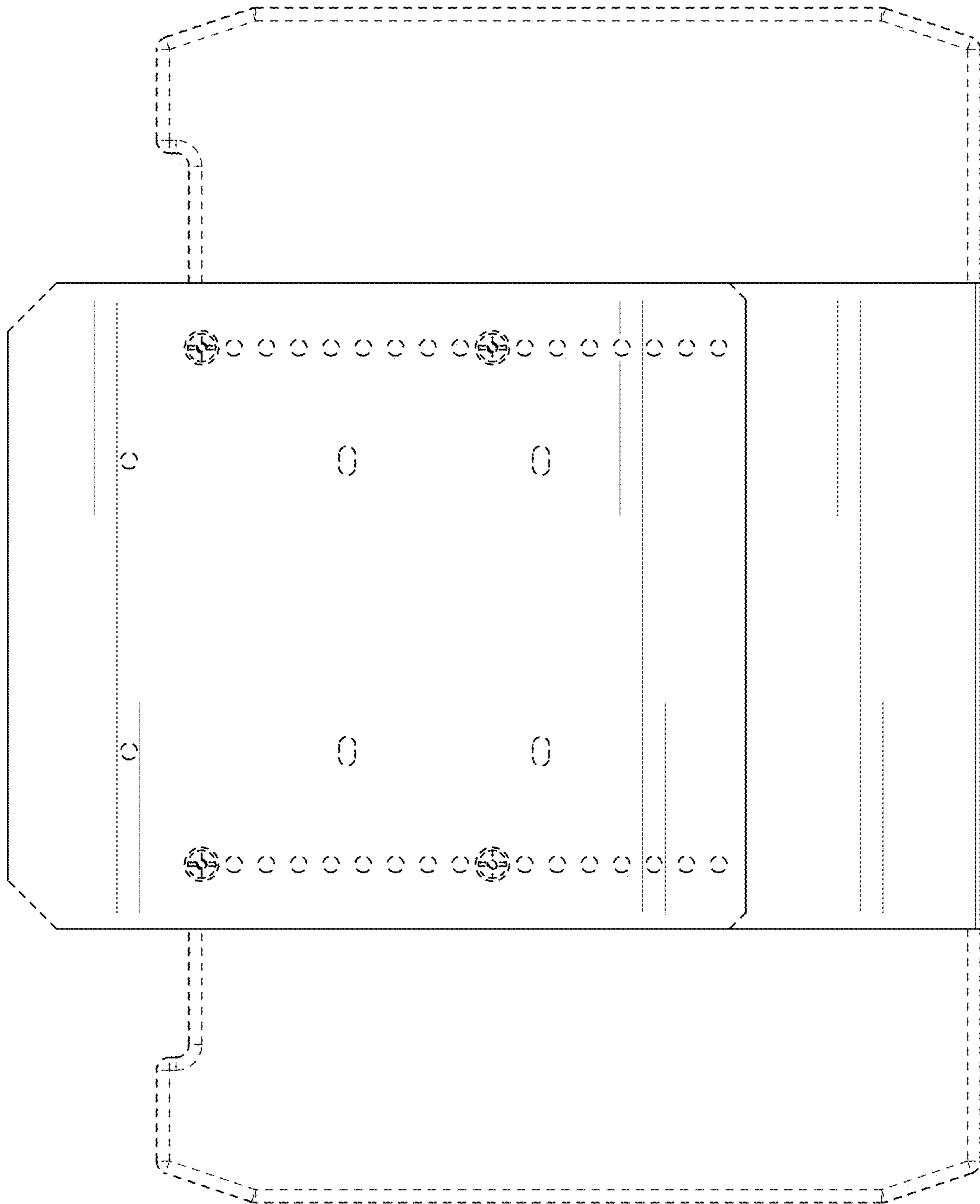

FIG. 17

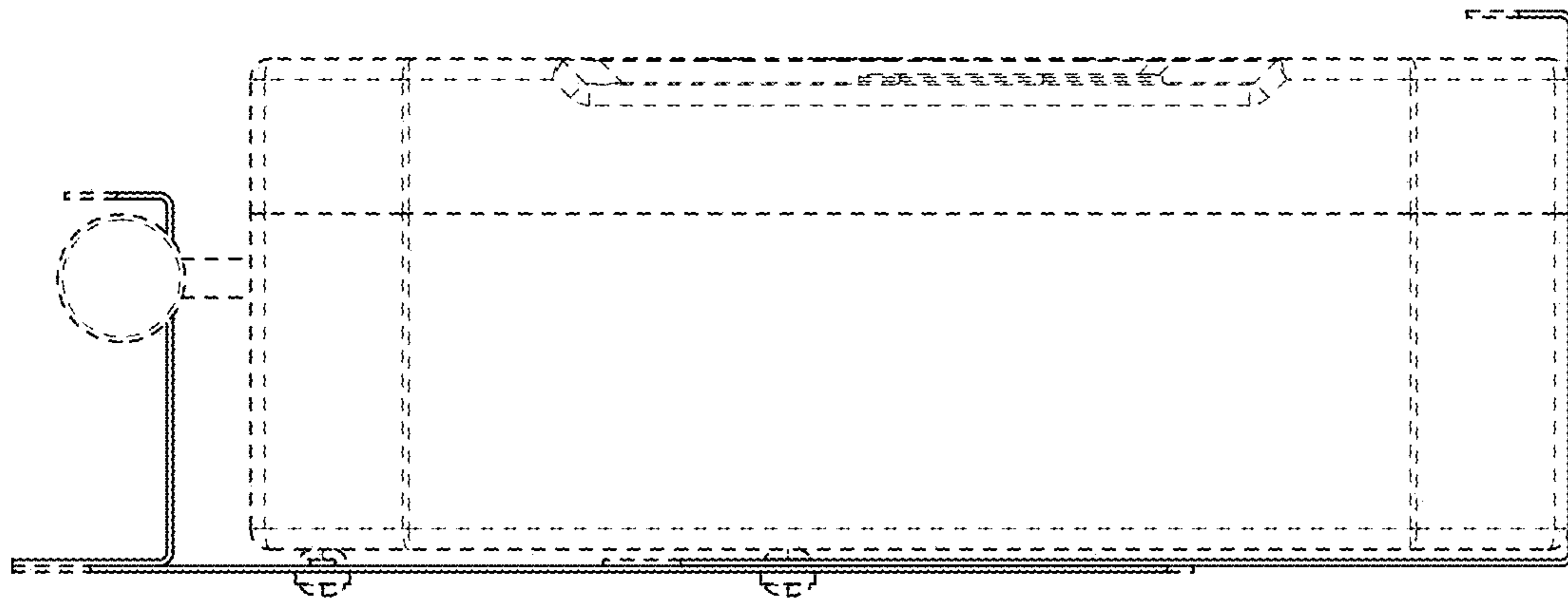

FIG. 18



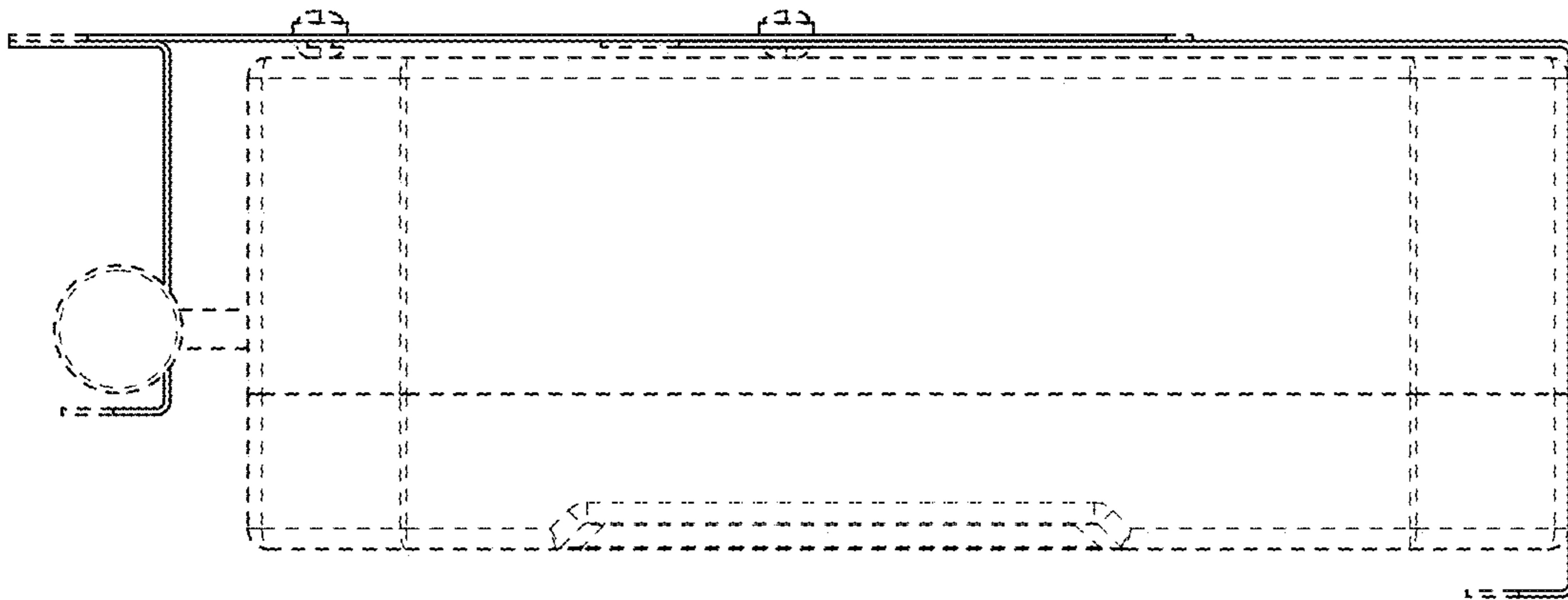

FIG. 19

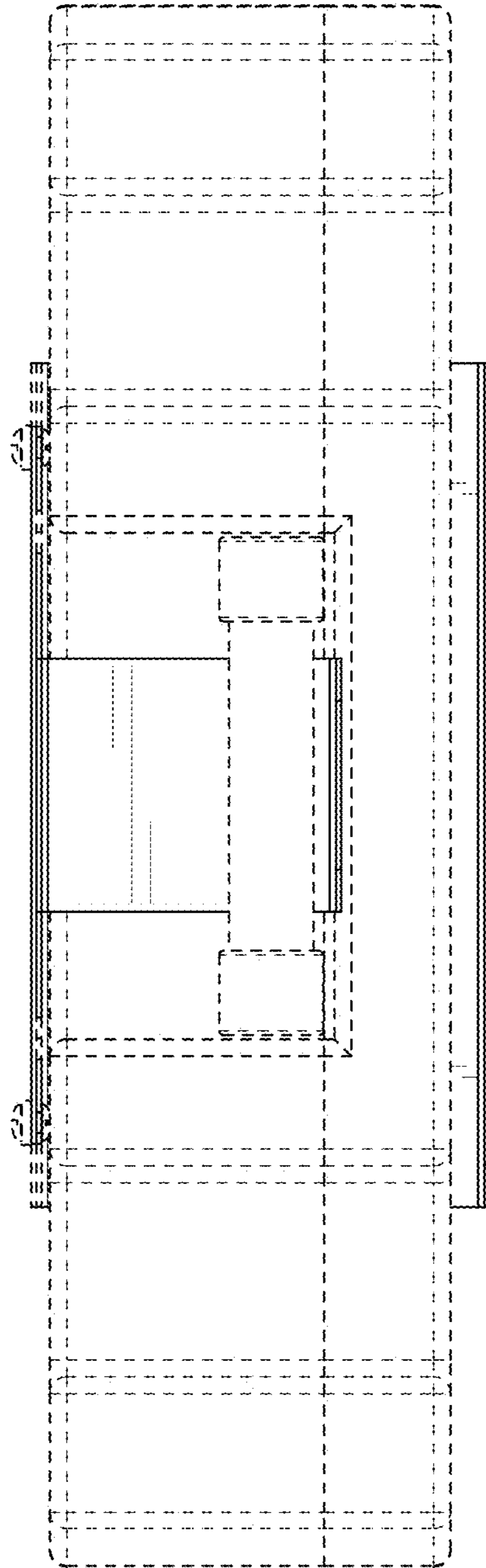

FIG. 20

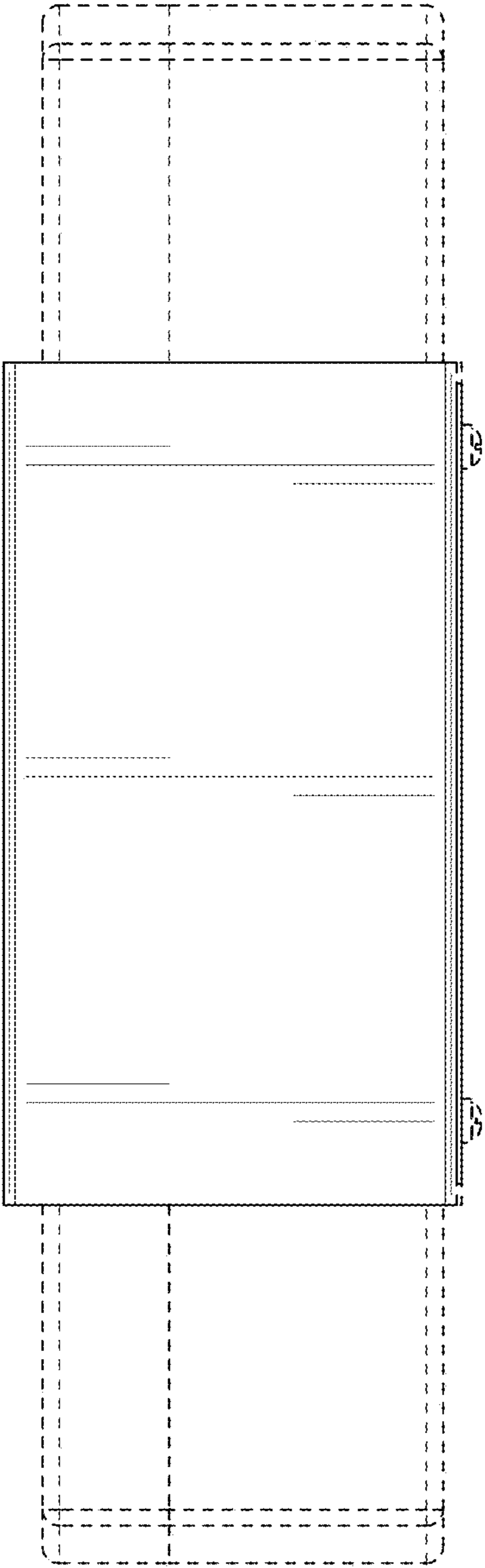

FIG. 21