

US00D932257S

(12) **United States Design Patent**
Gallop

(10) **Patent No.:** **US D932,257 S**

(45) **Date of Patent:** **** Oct. 5, 2021**

(54) **FORK**

(71) Applicant: **Waddington North America, Inc.**,
Chelmsford, MA (US)

(72) Inventor: **William A Gallop**, Westminster, MA
(US)

(73) Assignee: **Waddington North America, Inc.**,
Chelmsford, MA (US)

(**) Term: **15 Years**

(21) Appl. No.: **29/722,301**

(22) Filed: **Jan. 28, 2020**

(51) **LOC (13) Cl.** **07-03**

(52) **U.S. Cl.**
USPC **D7/653**

(58) **Field of Classification Search**
USPC D7/642-645, 653; 30/115, 129, 134,
30/136, 137, 142, 147, 148, 149, 150
CPC A47G 21/02; A47G 21/06; A47G 21/103;
B26B 11/00; B26B 29/025
See application file for complete search history.

(56) **References Cited**

U.S. PATENT DOCUMENTS

77,026	A *	4/1868	Frary	A47G 21/02 30/322
88,370	A *	3/1869	Cox	A47G 21/08 30/148
512,162	A	1/1894	Cuddy		
2,141,684	A	12/1938	Diemer		
2,149,099	A	2/1939	Phinney et al.		
2,216,005	A	9/1940	Morris		
2,752,678	A	7/1956	Welch		
2,911,127	A	11/1959	Driss et al.		
D231,071	S	4/1974	Hill		
D236,070	S	7/1975	Dart		
4,134,519	A	1/1979	Barnett et al.		
D252,315	S	7/1979	Dart		

D275,167	S	8/1984	Laslo		
4,524,512	A	6/1985	Formo et al.		
4,539,749	A	9/1985	Hyeing-Woon		
4,610,087	A	9/1986	Mickelson et al.		
4,995,154	A	2/1991	Bamber		
5,131,562	A	7/1992	Brown		
5,904,250	A	5/1999	De Schutter		
6,250,498	B1	6/2001	Lovejoy		
6,296,957	B1	10/2001	Graage		
6,336,568	B1 *	1/2002	Tucker	A47F 1/10 221/131

(Continued)

OTHER PUBLICATIONS

“Amazon 50 Piece Premium Silver Plastic Forks” available Jan. 28, 2019, [online], [site visited Feb. 8, 2021]. Retrieved from Internet, URL:https://www.amazon.com/Convenient-Silverware-Ludere-Elegant-Disposable/dp/B07PWHLYZP/ref=psdc_15757571_t3_B017ZAPCPA?th=1 (Year: 2019).*

(Continued)

Primary Examiner — Michael C Stout
Assistant Examiner — Katrina N Gonzalez
(74) *Attorney, Agent, or Firm* — Maine Cernota & Rardin

(57) **CLAIM**

The ornamental design for the fork, as shown and described.

DESCRIPTION

FIG. 1 is a top perspective view of the fork of the present design;
FIG. 2 is a bottom perspective view thereof;
FIG. 3 is a right side view thereof;
FIG. 4 is a left side view thereof;
FIG. 5 is an enlarged front view thereof;
FIG. 6 is an enlarged rear view thereof;
FIG. 7 is a top view thereof; and,
FIG. 8 is a bottom view thereof.

1 Claim, 8 Drawing Sheets

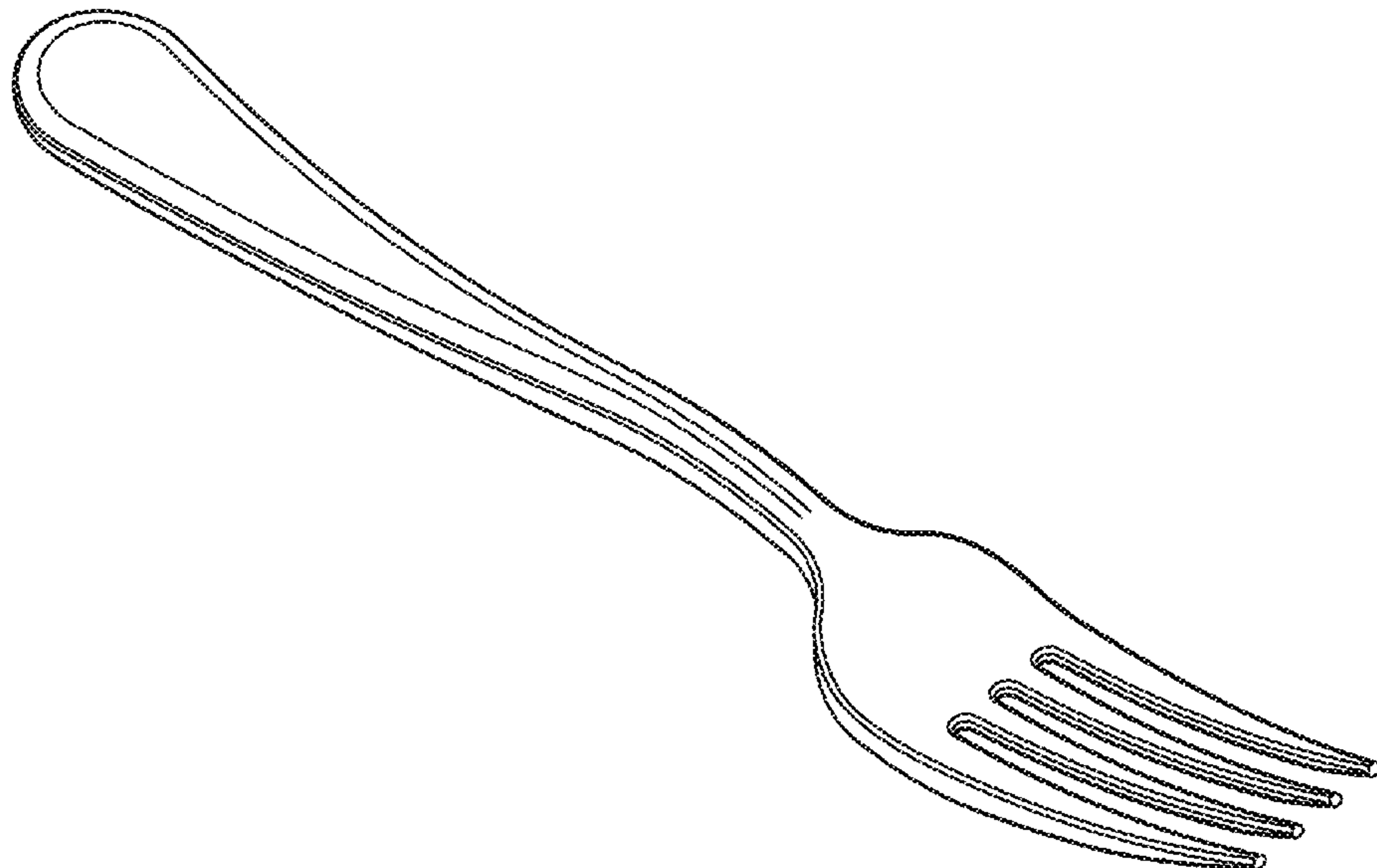

(56)

References Cited

U.S. PATENT DOCUMENTS

6,832,694 B2 12/2004 Goeking et al.
 D507,158 S 7/2005 Smith et al.
 7,013,568 B2 3/2006 Schmidt
 D551,913 S * 10/2007 Kasper D7/653
 D584,084 S 1/2009 Tucker et al.
 D596,457 S * 7/2009 Claps D7/401.2
 D608,143 S 1/2010 Kasper
 7,669,732 B2 3/2010 Njaastad
 D623,907 S 9/2010 Lenge
 D628,436 S 12/2010 Koennecke et al.
 D634,974 S 3/2011 Oakes
 7,900,797 B1 3/2011 Witcraft
 8,272,533 B1 9/2012 D'Amelia et al.
 8,297,473 B2 10/2012 Smith
 8,839,522 B2 9/2014 Walters
 9,049,948 B2 6/2015 Jongen
 D752,398 S 3/2016 Mou
 D778,121 S 2/2017 Mou
 D778,122 S * 2/2017 Mou D7/653
 D795,656 S 8/2017 McFarland et al.

D849,472 S * 5/2019 Estabrooks D7/401.2
 D852,006 S 6/2019 Oakes
 2007/0000136 A1 1/2007 Allen et al.
 2007/0108141 A1 5/2007 Smith et al.
 2010/0170915 A1 7/2010 Reinsei et al.
 2011/0138632 A1 6/2011 Wong
 2011/0219631 A1 9/2011 Hou

OTHER PUBLICATIONS

“Reflections Petal 7" Fork” available Feb. 8, 2021, [online], [site visited Feb. 8, 2021]. Retrieved from Internet, URL:[http://www.wna.biz/catalog/?keyword=fork&submitSearch=\(Year: 2021\)](http://www.wna.biz/catalog/?keyword=fork&submitSearch=(Year:2021)).
 “Amazon Royal 12-Piece Mini Dessert Forks Set” available Sep. 12, 2017, [online], [site visited Feb. 8, 2021]. Retrieved from Internet, URL:https://www.amazon.com/Royal-12-Piece-Mini-Dessert-Forks/dp/B075KYPXTH/ref=sr_1_126?dchild=1&keywords=fork&qid=1612819305&sr=8-126&th=1 (Year: 2017).
 Notice of Allowability for Design U.S. Appl. No. 29/722,298, dated Jan. 8, 2021, 15 Pages.

* cited by examiner

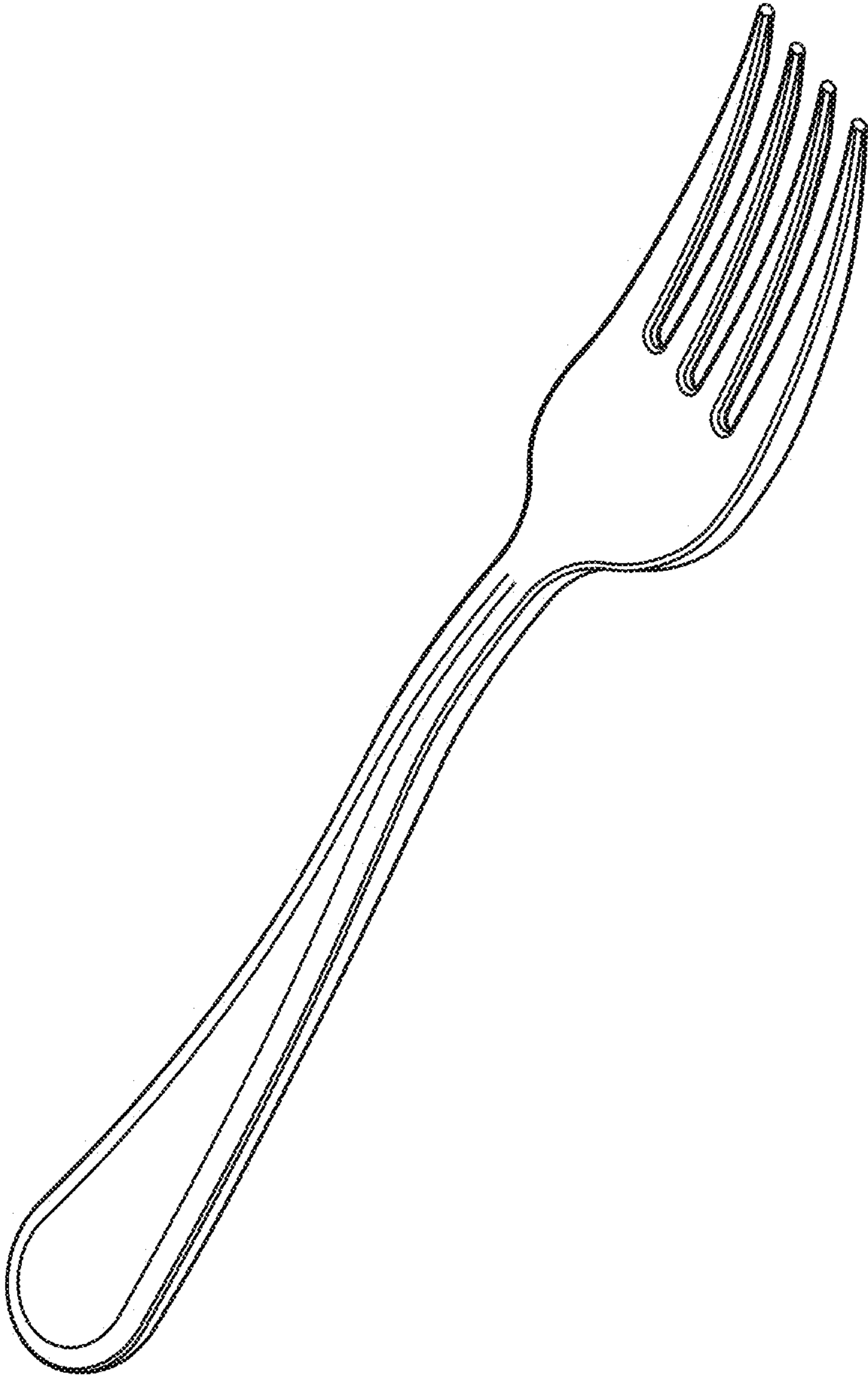

Fig. 1

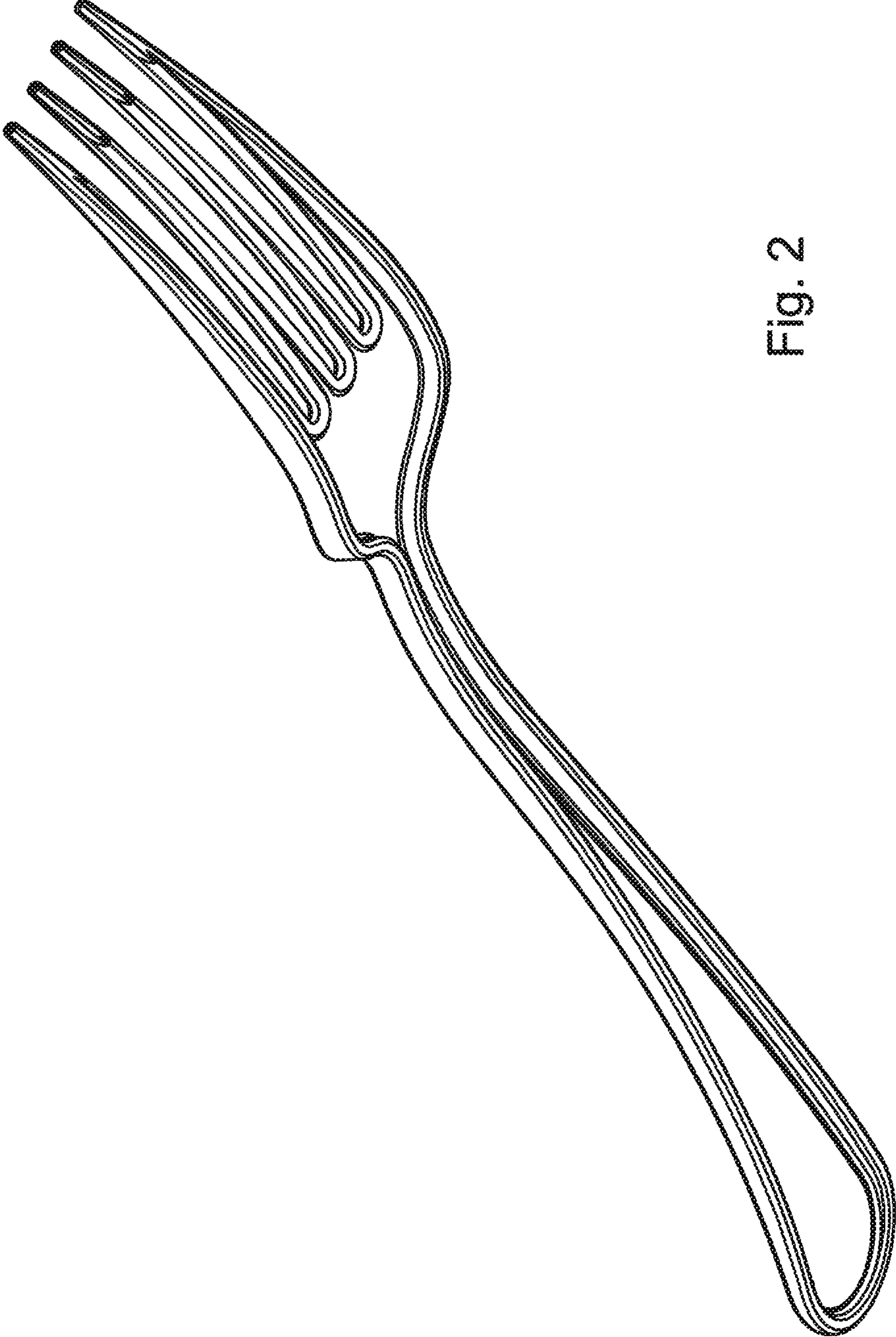

Fig. 2

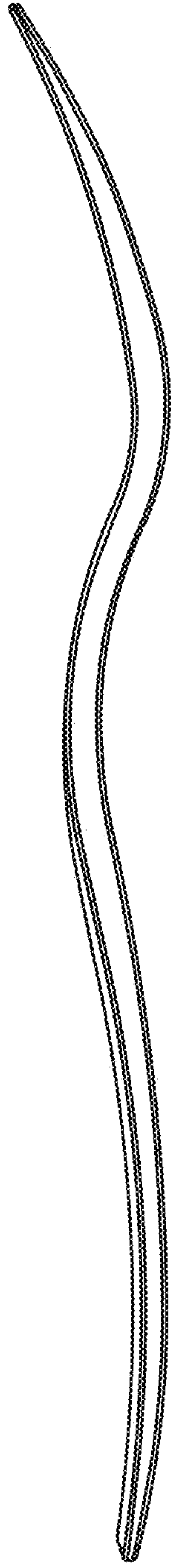

Fig. 3

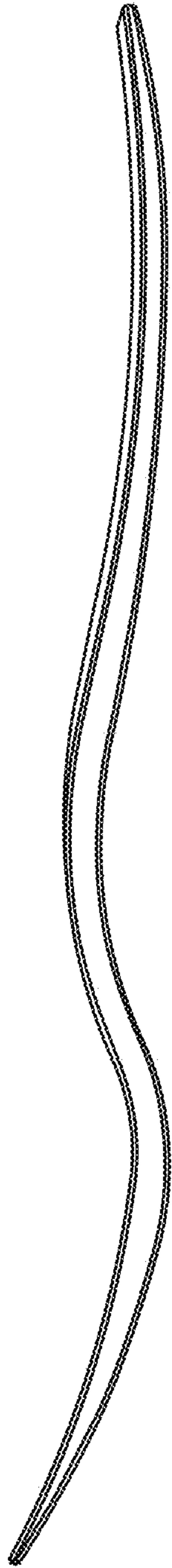

Fig. 4

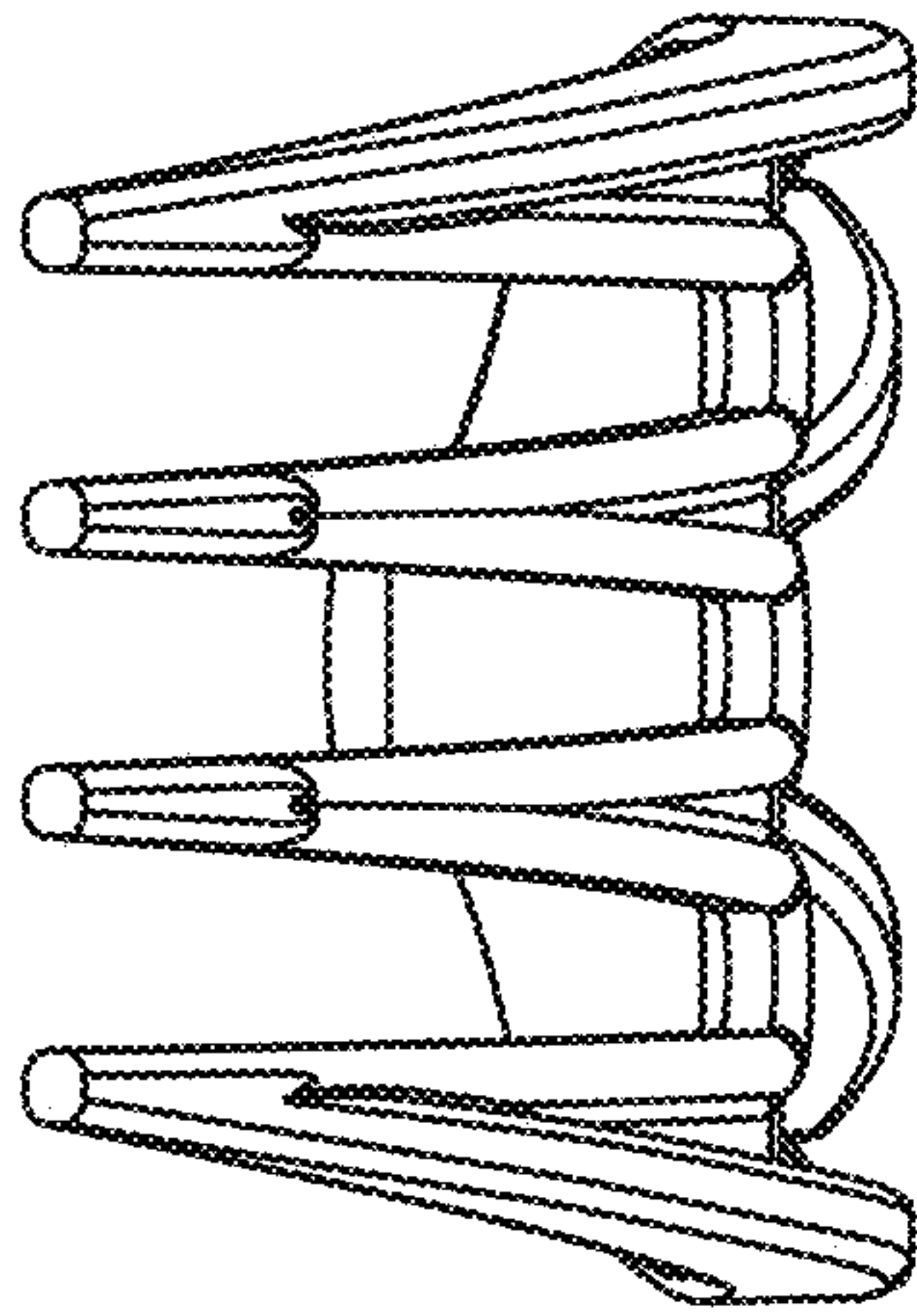

Fig. 5

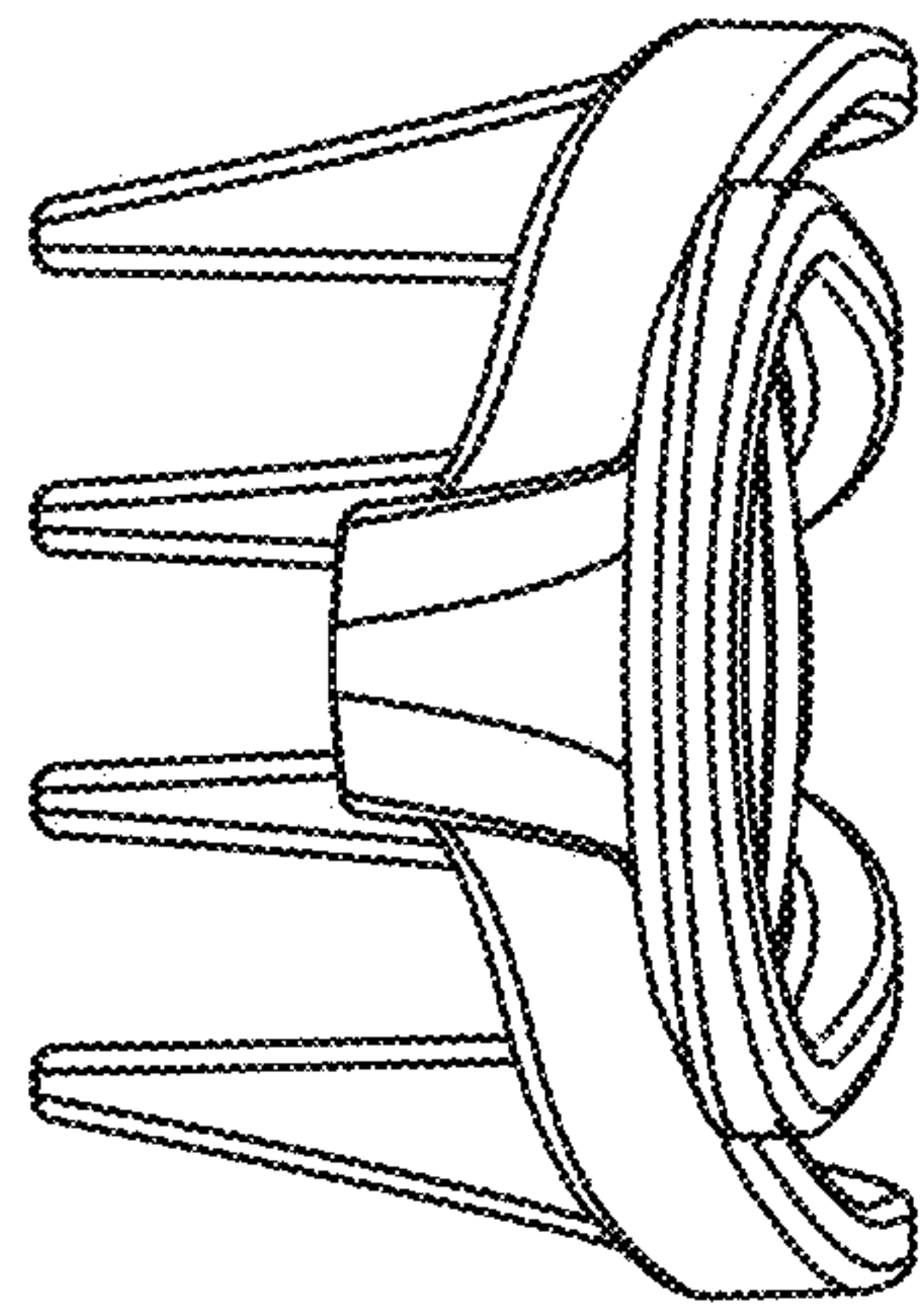

Fig. 6

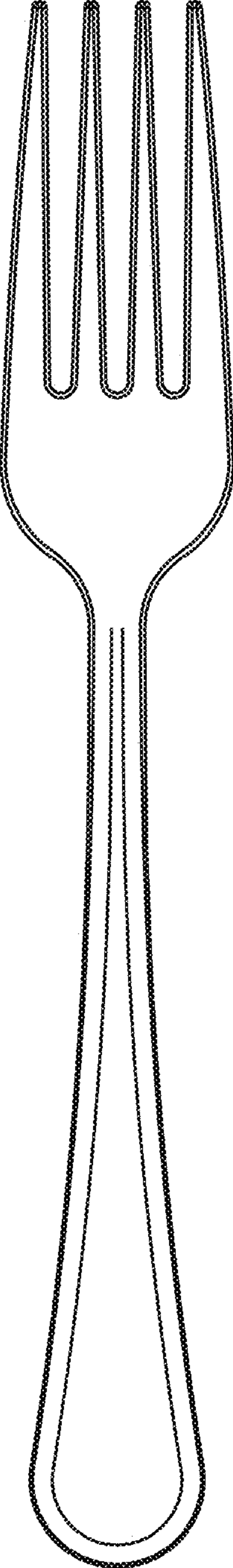

Fig. 7

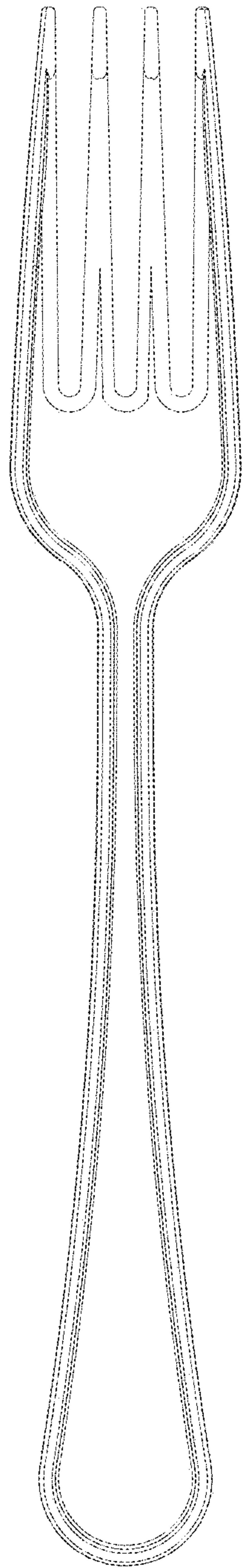

Fig. 8