



US00D932239S

(12) **United States Design Patent**
Sitwell et al.

(10) **Patent No.:** **US D932,239 S**

(45) **Date of Patent:** **** Oct. 5, 2021**

(54) **BOTTLE CLOSURE WITH LIQUID DISPENSER**

(71) Applicant: **Dexos Drinks Limited**, London (GB)

(72) Inventors: **Vincent Sitwell**, Barnet (GB); **Lucas Karel Johannes Van Den Broek**, Wadhurst (GB)

(**) Term: **15 Years**

(21) Appl. No.: **29/672,658**

(22) Filed: **Dec. 7, 2018**

(30) **Foreign Application Priority Data**

Jun. 8, 2018 (GB) 1809483

Nov. 30, 2018 (EM) 005840022

(51) **LOC (13) Cl.** **07-01**

(52) **U.S. Cl.**
USPC **D7/392.1; D7/396.2**

(58) **Field of Classification Search**
USPC D7/507, 509, 510, 511, 513, 529, 531, D7/532, 523, 533, 534, 535, 536, 392.1, D7/396.1, 396.2; D3/202; D9/500, 501, D9/502, 503, 504, 556, 569, 557, 570, D9/442, 520, 436, 447
CPC A47G 19/22; A47G 19/2277; A47F 3/20; A47F 2003/205

See application file for complete search history.

(56) **References Cited**

U.S. PATENT DOCUMENTS

D115,412 S * 6/1939 Lacy D7/361
D453,449 S * 2/2002 Williams D7/624.2
D668,905 S * 10/2012 Lane D7/318
D823,070 S * 7/2018 Boroski D7/608
D876,886 S * 3/2020 Sitwell D7/392.1
D896,576 S * 9/2020 Wolfgram D7/396.2
2019/0075950 A1 * 3/2019 Xu A47G 21/18

* cited by examiner

Primary Examiner — Jae Liang

(74) *Attorney, Agent, or Firm* — William H. Bollman

(57) **CLAIM**

The ornamental design for a bottle closure with liquid dispenser, as shown and described.

DESCRIPTION

FIG. 1 is a front upper perspective view of a bottle closure with liquid dispenser, showing its new design;
FIG. 2 is a top view thereof;
FIG. 3 is a front view thereof;
FIG. 4 is a left side view thereof; the right side view being a mirror image thereof;
FIG. 5 is a front lower perspective view thereof; and,
FIG. 6 is a bottom view thereof.

1 Claim, 6 Drawing Sheets

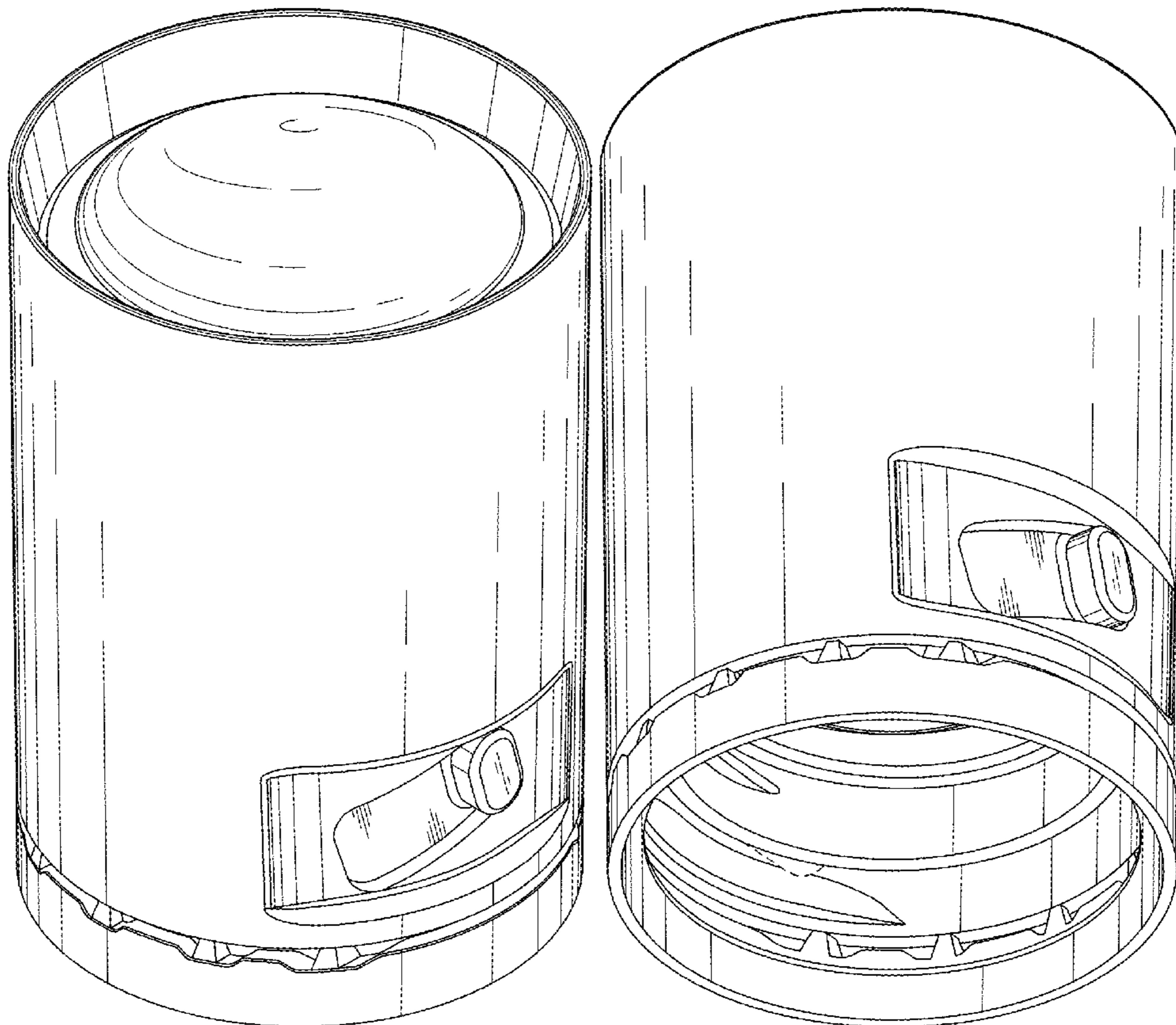

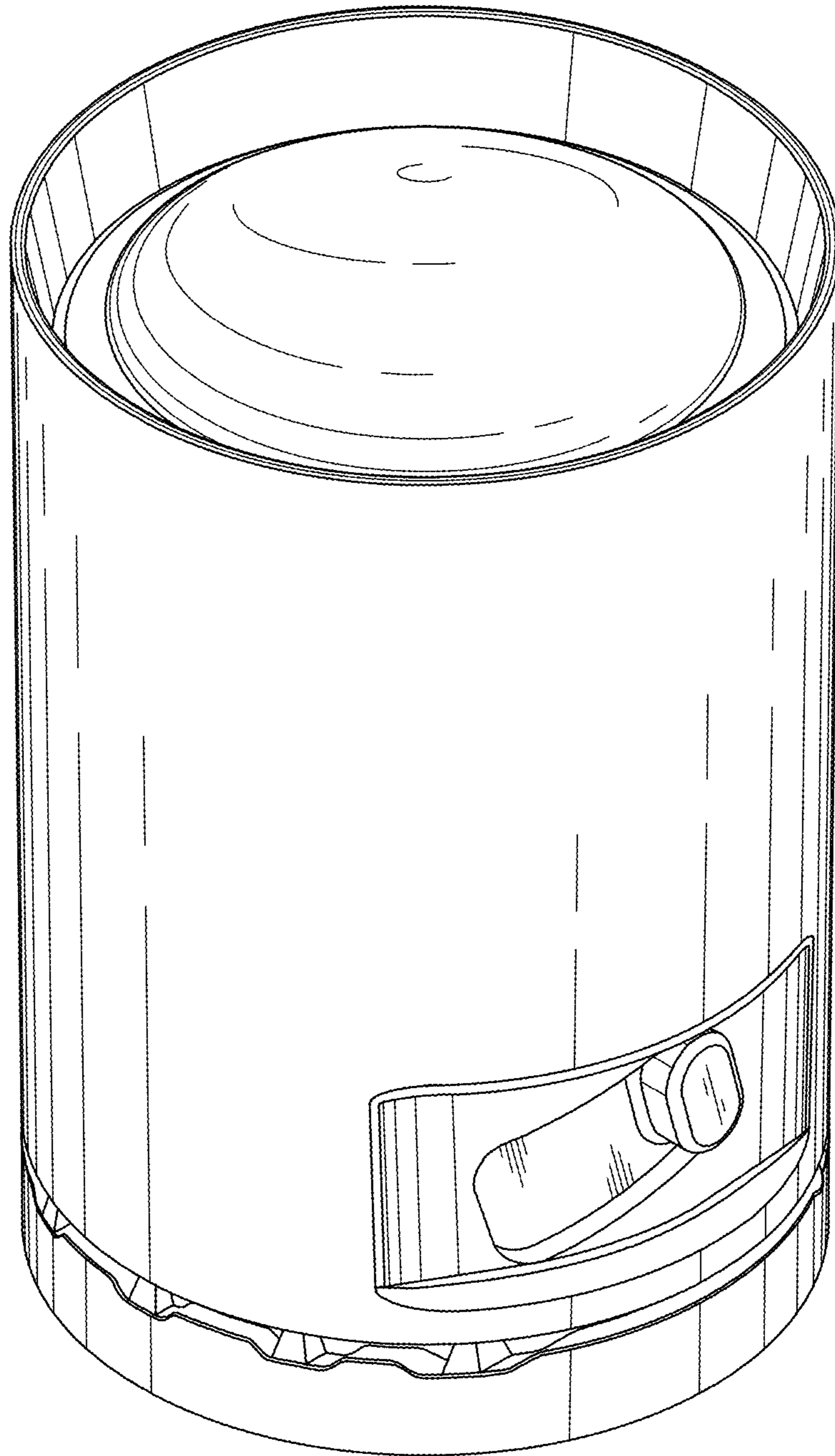

FIG. 1

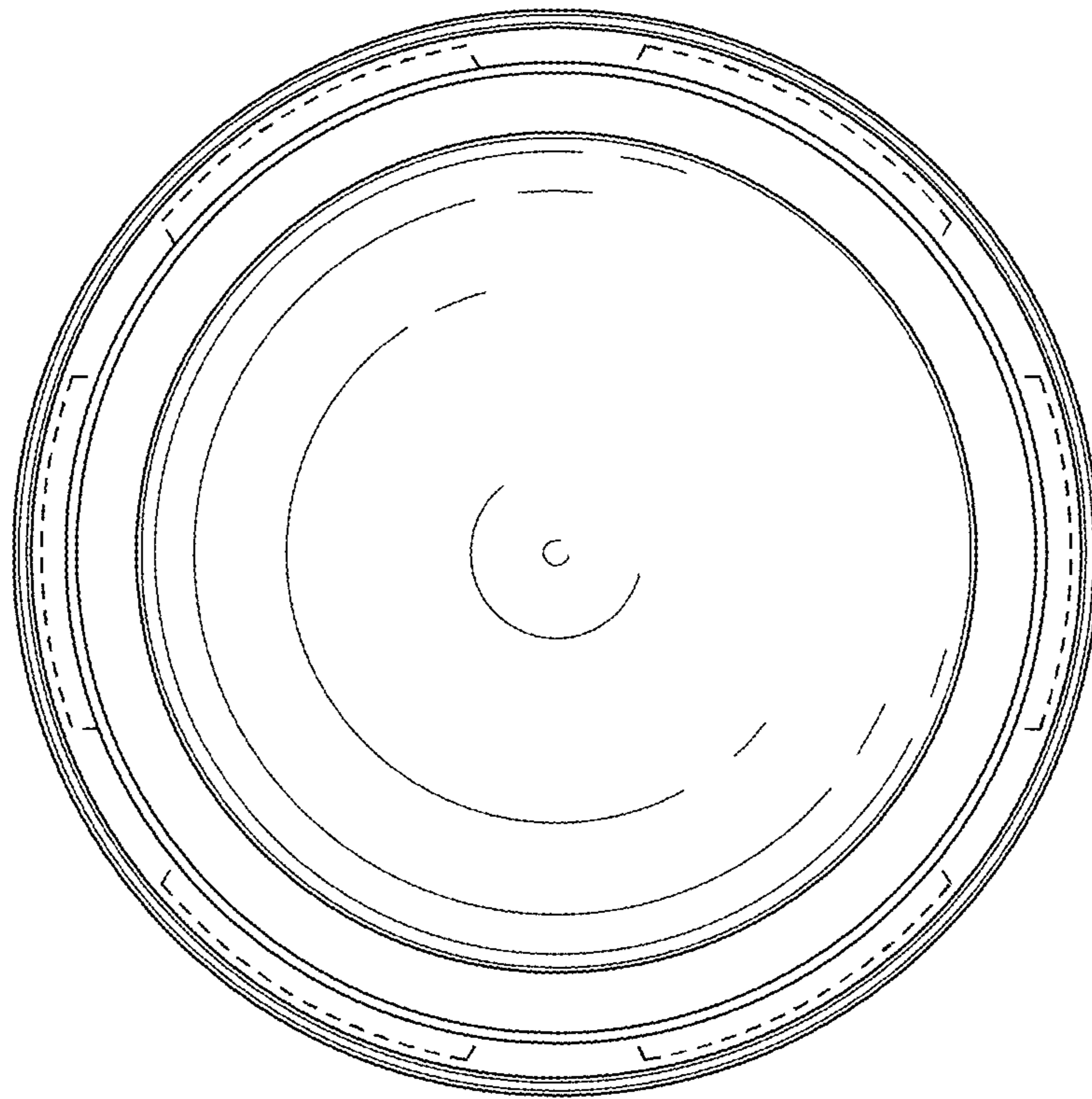

FIG. 2

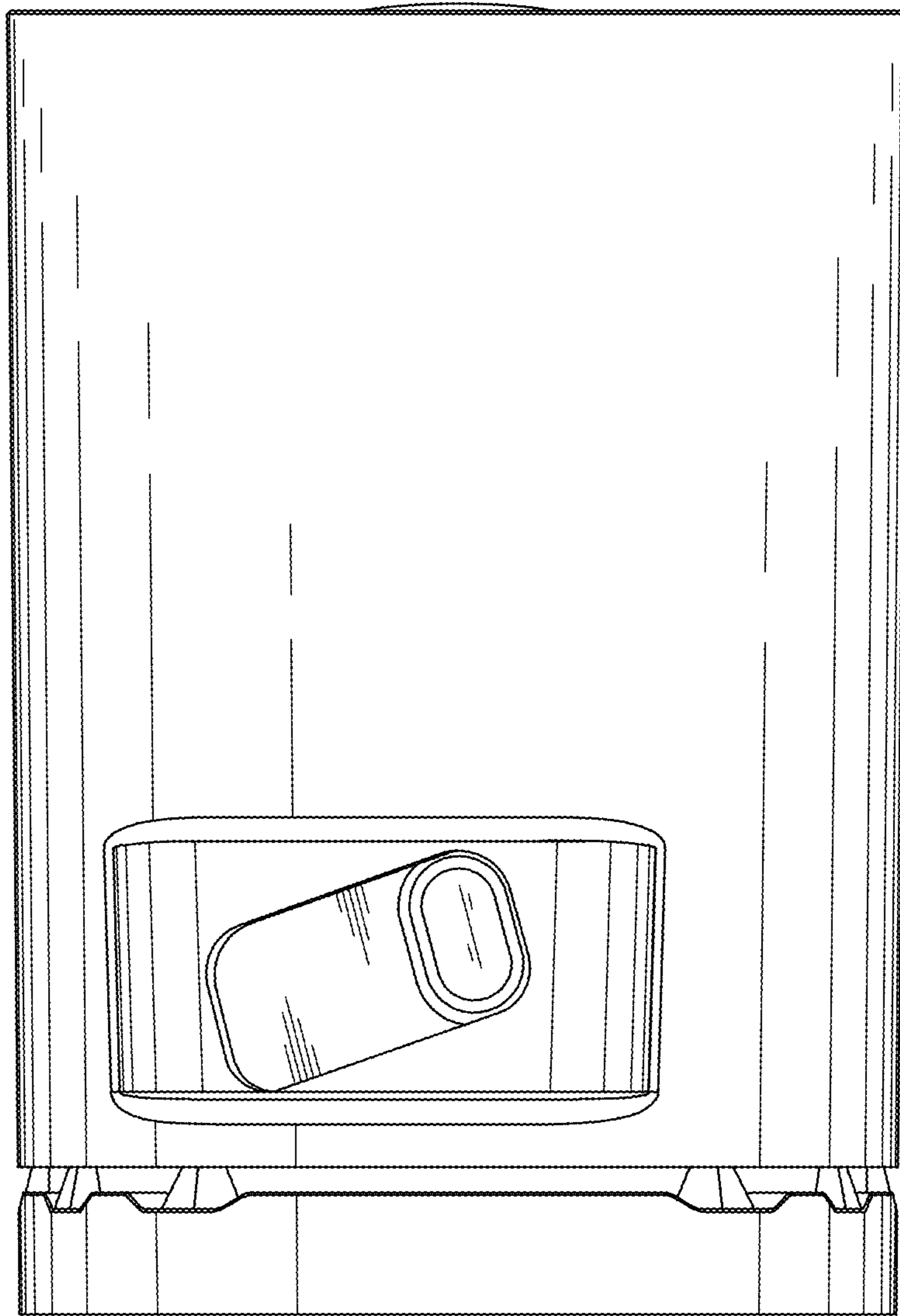

FIG. 3

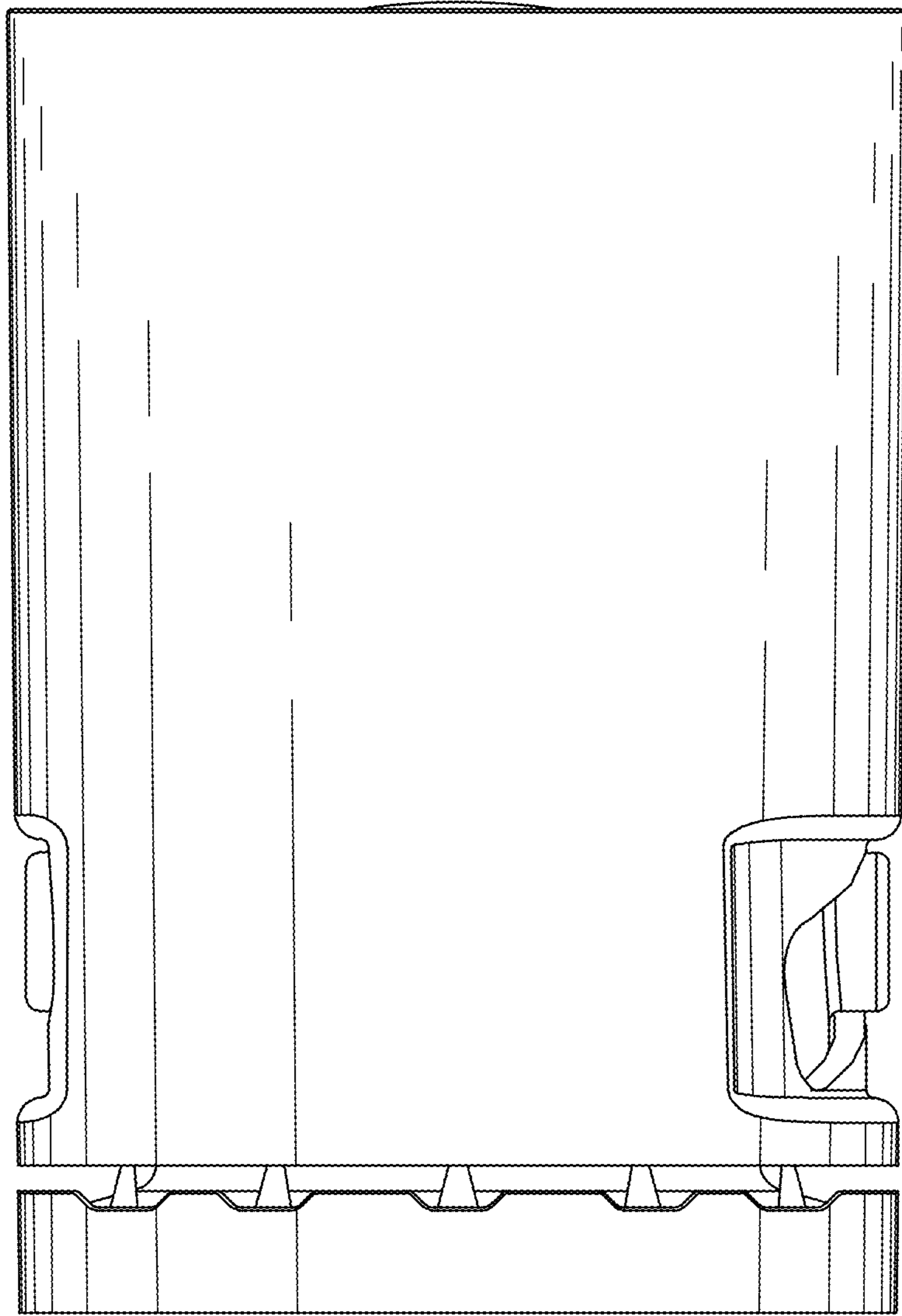

FIG. 4

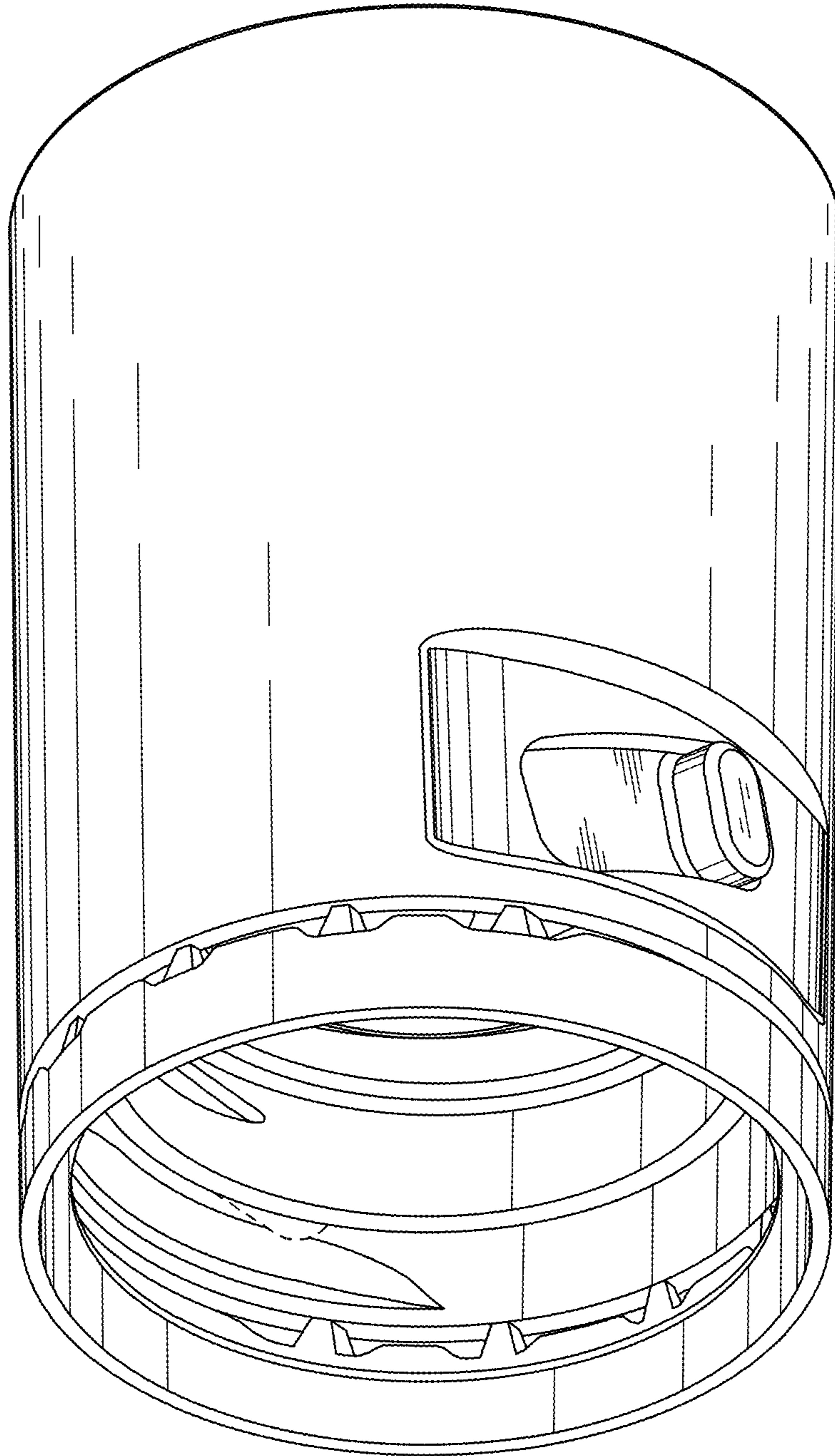

FIG. 5

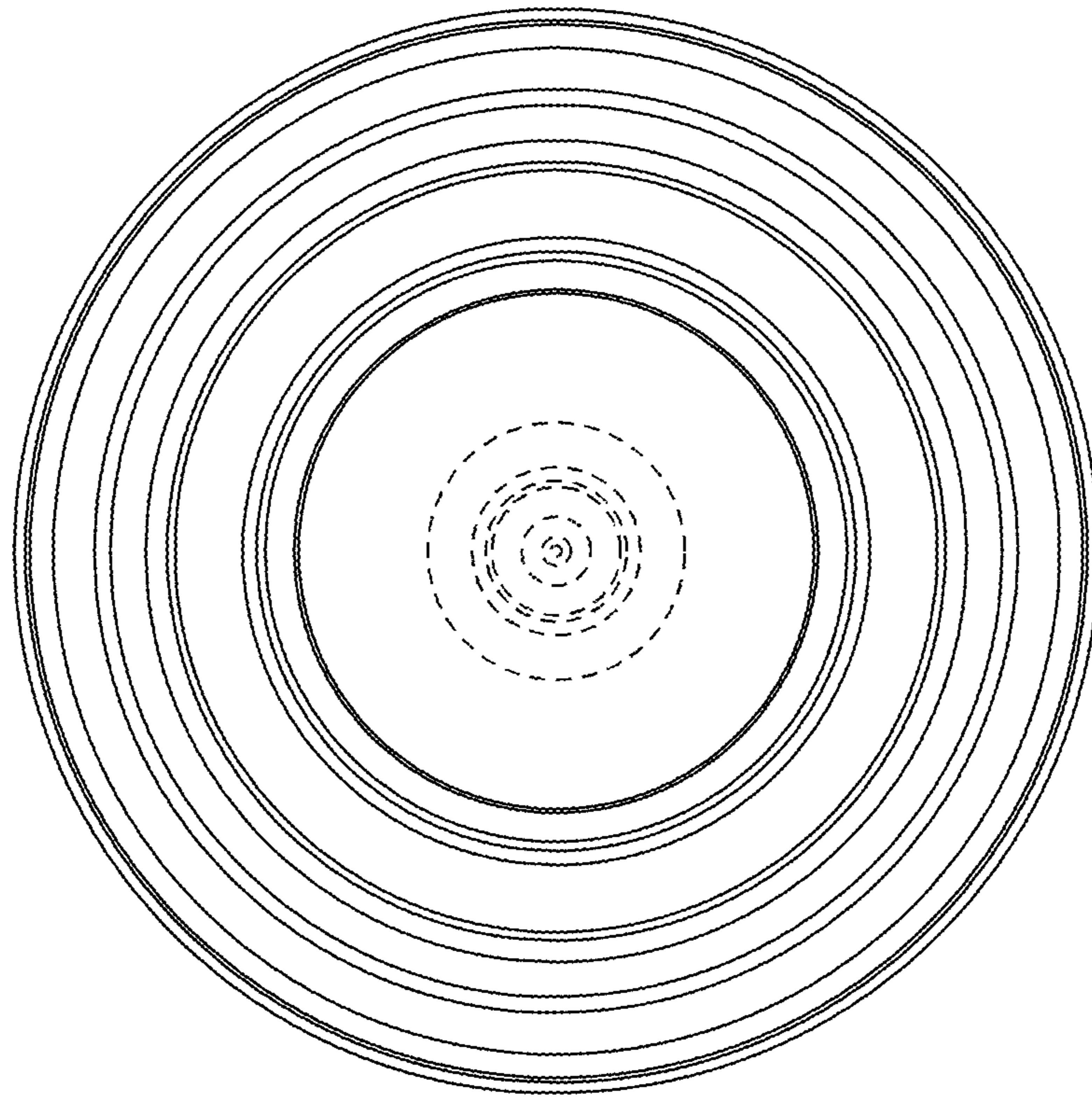

FIG. 6