



US00D932198S

(12) **United States Design Patent** (10) **Patent No.:** **US D932,198 S**  
**Sze** (45) **Date of Patent:** **\*\* Oct. 5, 2021**

(54) **MIRROR APPARATUS**  
(71) Applicant: **TUNG HING PLASTIC MANUFACTORY LTD.,** Kowloon (HK)  
(72) Inventor: **Ka Chuen Sze,** Kowloon (HK)  
(73) Assignee: **TUNG HING PLASTIC MANUFACTORY LTD.,** Kowloon (HK)

(\*\*) Term: **15 Years**

(21) Appl. No.: **29/678,813**

(22) Filed: **Jan. 31, 2019**

(30) **Foreign Application Priority Data**

Aug. 7, 2018 (CN) ..... 201830432188.6

(51) **LOC (13) Cl.** ..... **06-07**

(52) **U.S. Cl.**  
USPC ..... **D6/309**

(58) **Field of Classification Search**  
USPC ..... D6/300-314; D28/64.1-64.7  
CPC ..... A47G 1/00; A47G 1/0633; A47G 1/0622;  
A47G 1/04; A47G 2200/08; A47G 2200/085; A45D 42/20  
See application file for complete search history.

(56) **References Cited**

**U.S. PATENT DOCUMENTS**

D661,910 S \* 6/2012 Yang ..... D6/312  
8,905,560 B1 \* 12/2014 Zadro ..... A45D 42/14  
359/876  
D776,945 S \* 1/2017 Yang ..... D6/309  
D848,158 S \* 5/2019 Yang ..... D6/309  
D865,375 S \* 11/2019 Yang ..... D6/310  
D873,574 S \* 1/2020 Wei ..... D6/309  
D891,791 S \* 8/2020 Zhu ..... D6/309  
D895,982 S \* 9/2020 Yang ..... D6/309

D899,107 S \* 10/2020 Luo ..... D6/309  
D905,443 S \* 12/2020 Yang ..... D6/310  
D905,446 S \* 12/2020 Yang ..... D6/310  
D905,449 S \* 12/2020 Yang ..... D6/310  
D905,976 S \* 12/2020 Yang ..... D6/310  
D909,768 S \* 2/2021 Li ..... D6/300  
D919,981 S \* 5/2021 Li ..... D6/309

**FOREIGN PATENT DOCUMENTS**

CN 306397696 \* 3/2021  
CN 306406094 \* 3/2021

\* cited by examiner

*Primary Examiner* — Deanna L Pratt

(74) *Attorney, Agent, or Firm* — Heslin Rothenberg Farley & Mesiti P.C.; Melvin Li

(57) **CLAIM**

The ornamental design for a mirror apparatus, as shown and described.

**DESCRIPTION**

FIG. 1 is a front perspective view of an embodiment of a new design showing a mirror apparatus according to the present invention;  
FIG. 2 is a rear perspective view of the mirror apparatus of FIG. 1;  
FIG. 3 is a front view of the mirror apparatus of FIG. 1;  
FIG. 4 is a bottom view of the mirror apparatus of FIG. 1;  
FIG. 5 is a top view of the mirror apparatus of FIG. 1;  
FIG. 6 is a rear view of the mirror apparatus of FIG. 1;  
FIGS. 7 and 8 are opposite side views of the mirror apparatus of FIG. 1;  
FIG. 9 is a rear perspective view of the mirror apparatus of FIG. 1, the mirror apparatus assuming a different configuration; and,  
FIG. 10 is a front perspective view of the mirror apparatus of FIG. 1 the mirror apparatus assuming a different configuration.

**1 Claim, 7 Drawing Sheets**

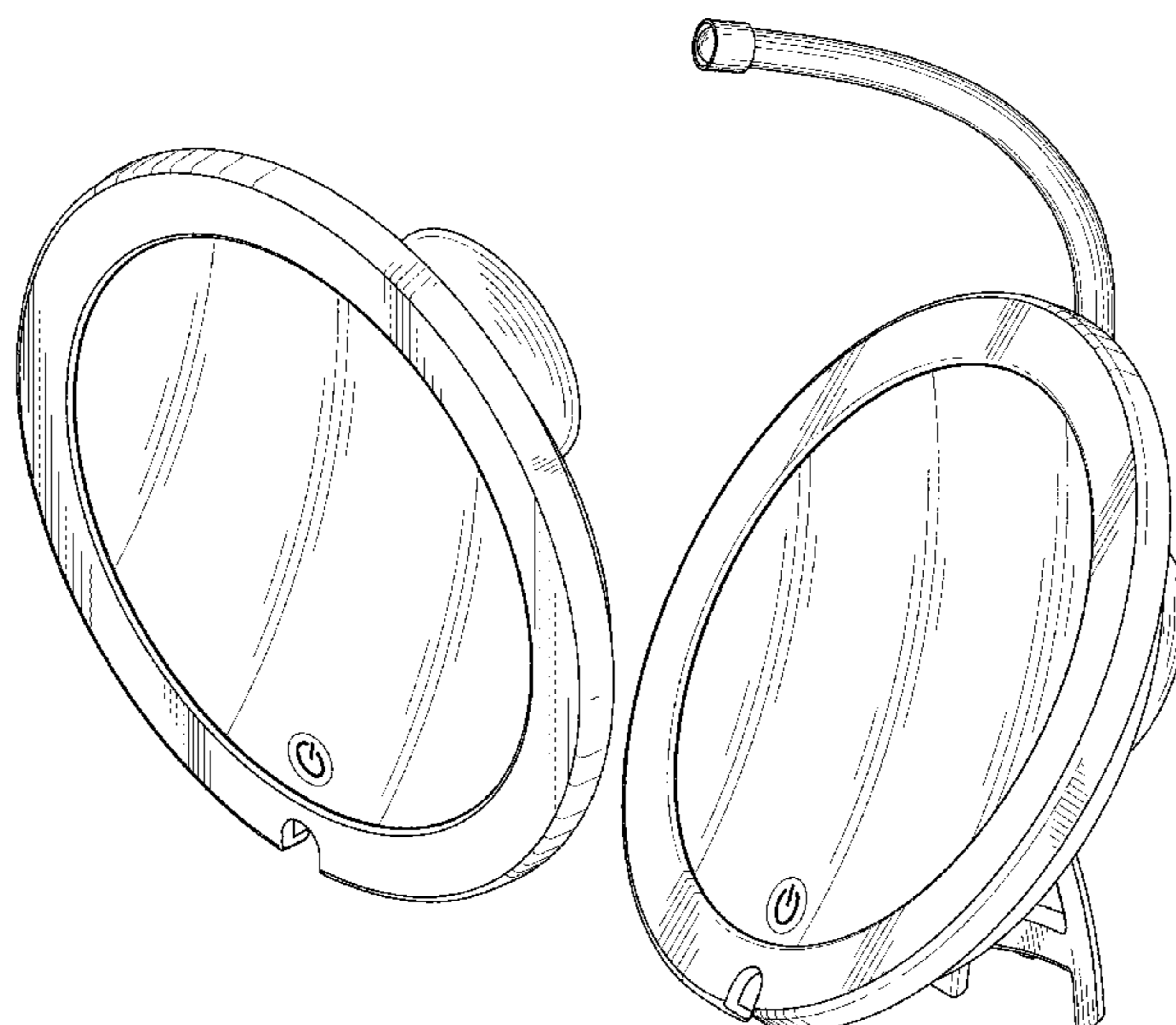

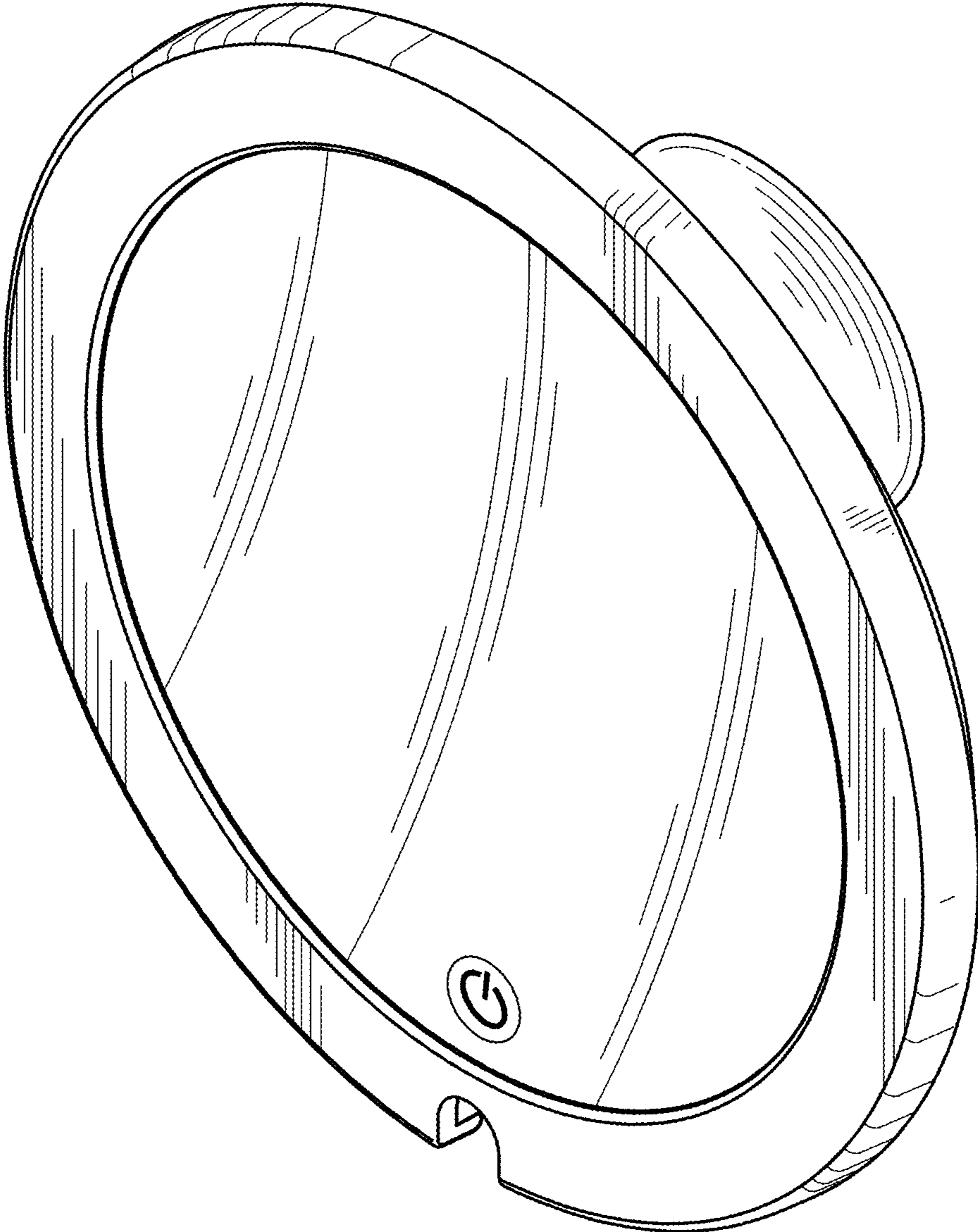

FIG. 1

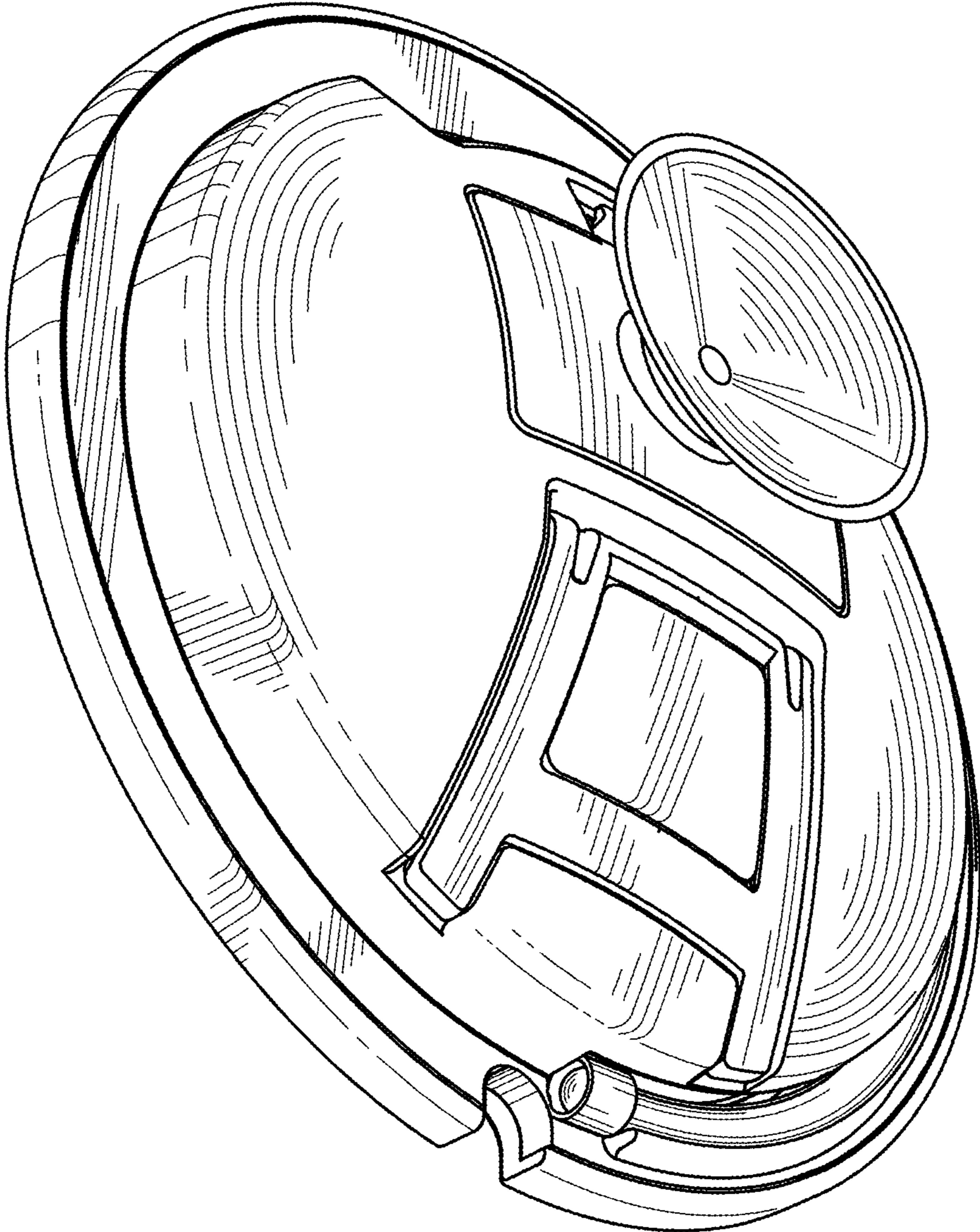

FIG. 2



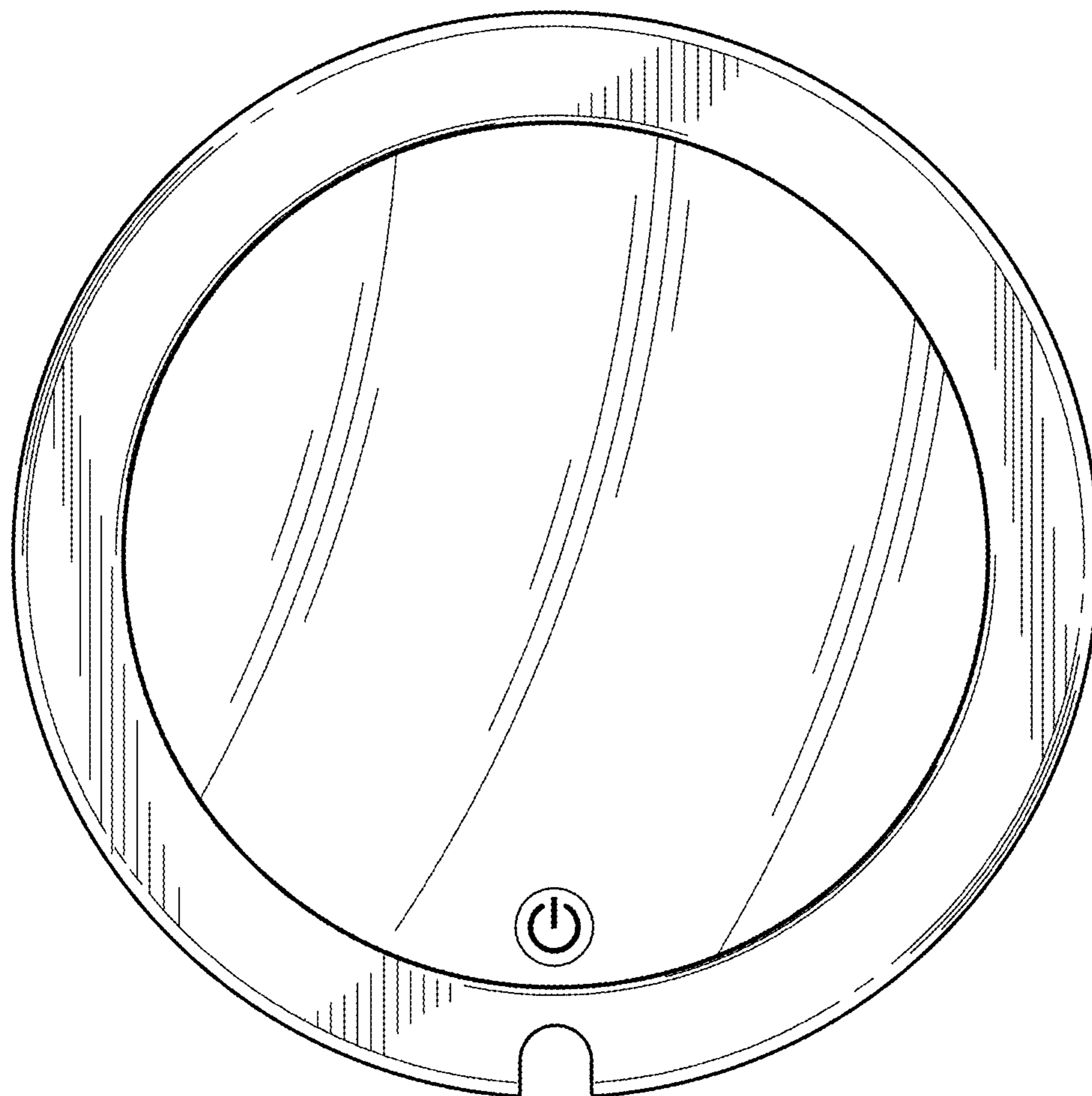

FIG. 3

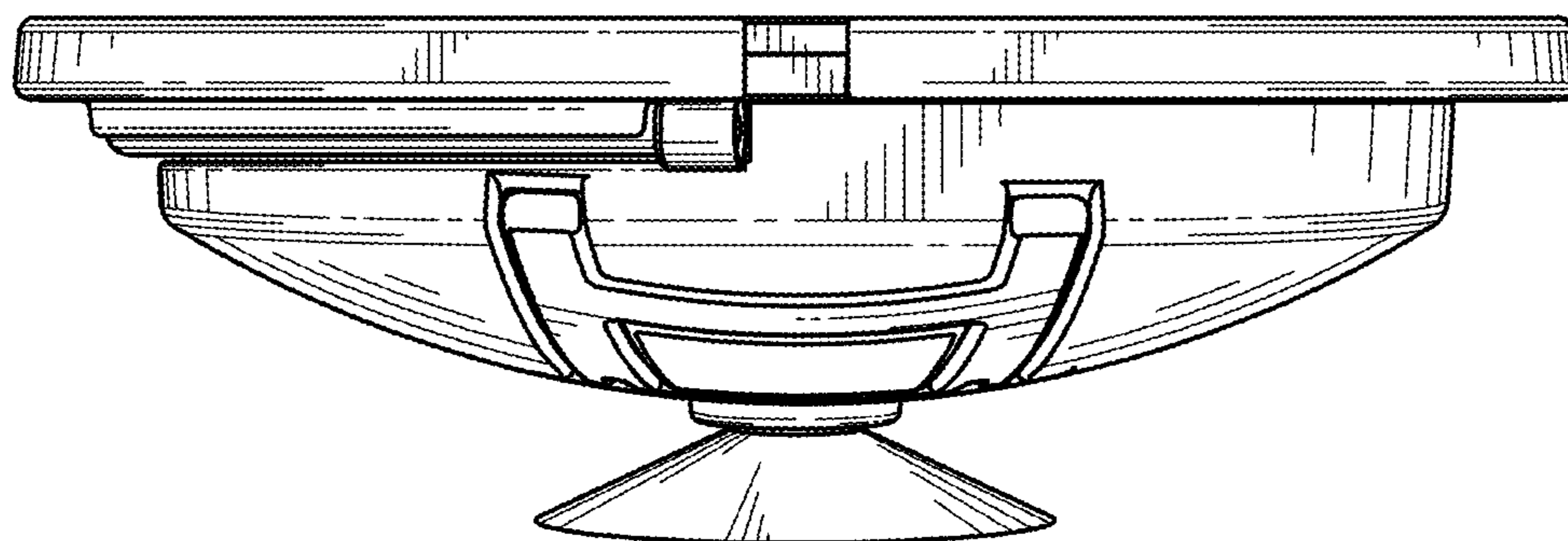

FIG. 4

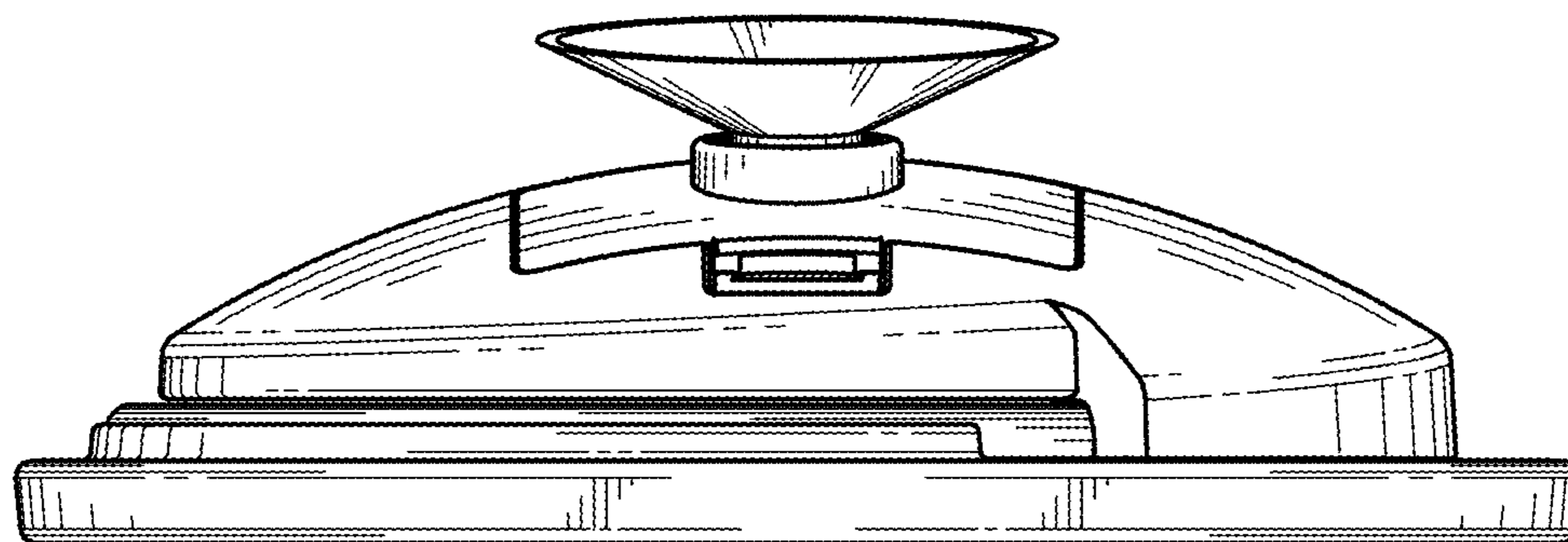

FIG. 5

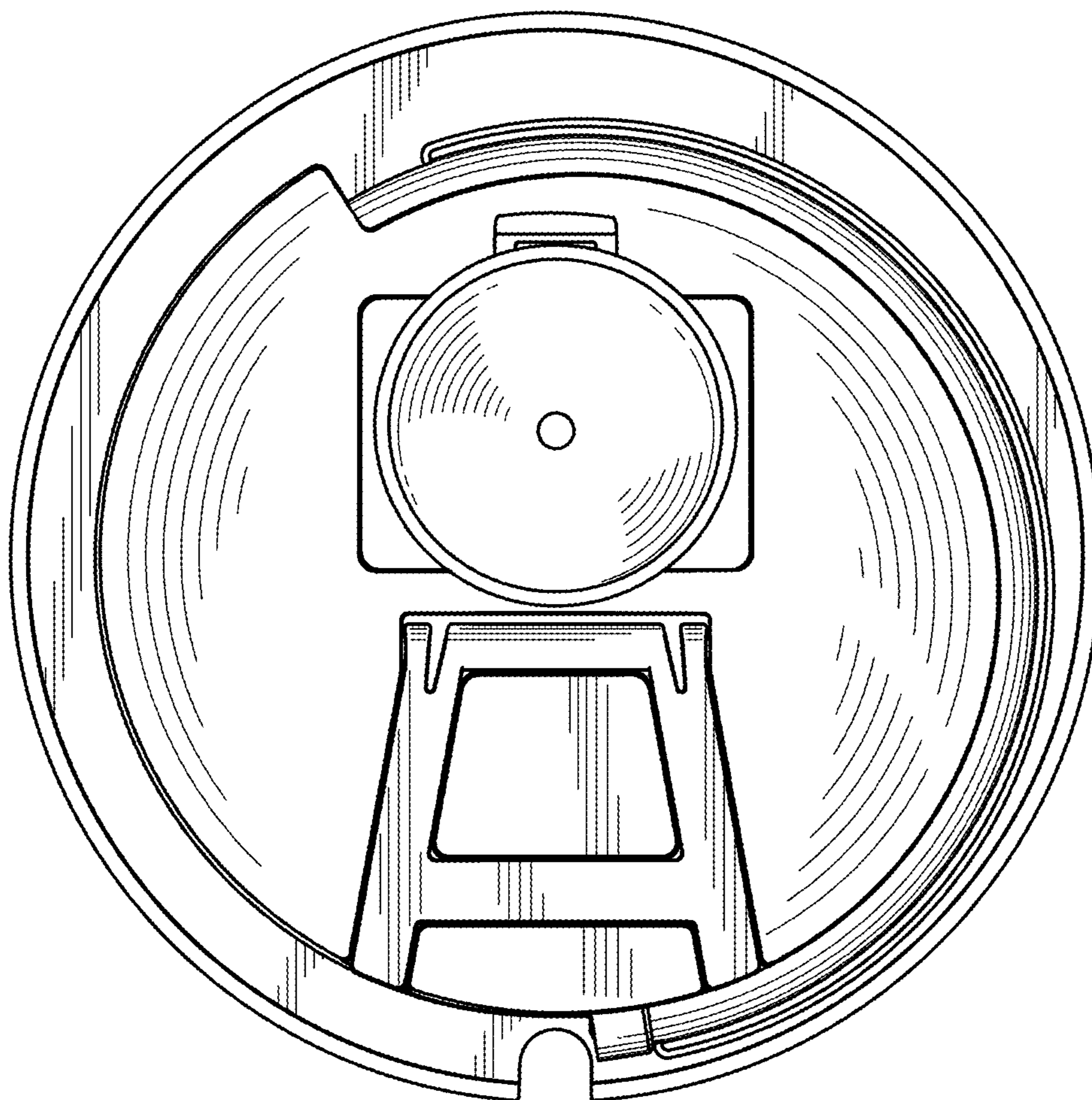

FIG. 6

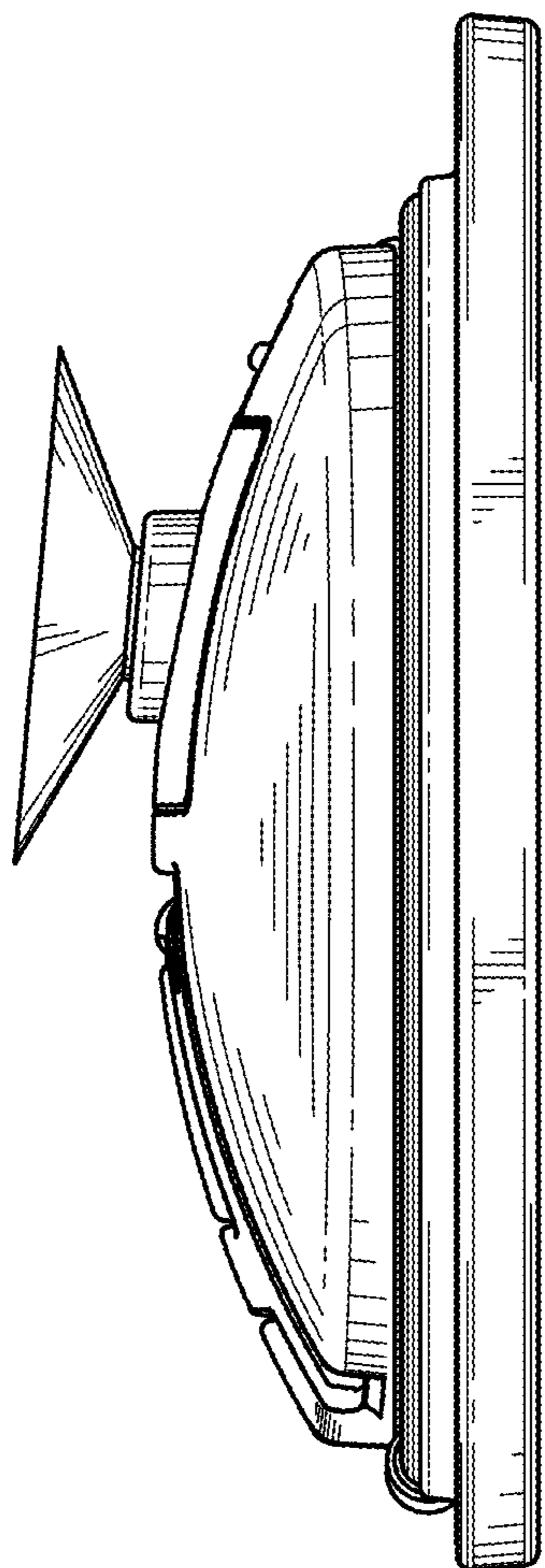

FIG. 7

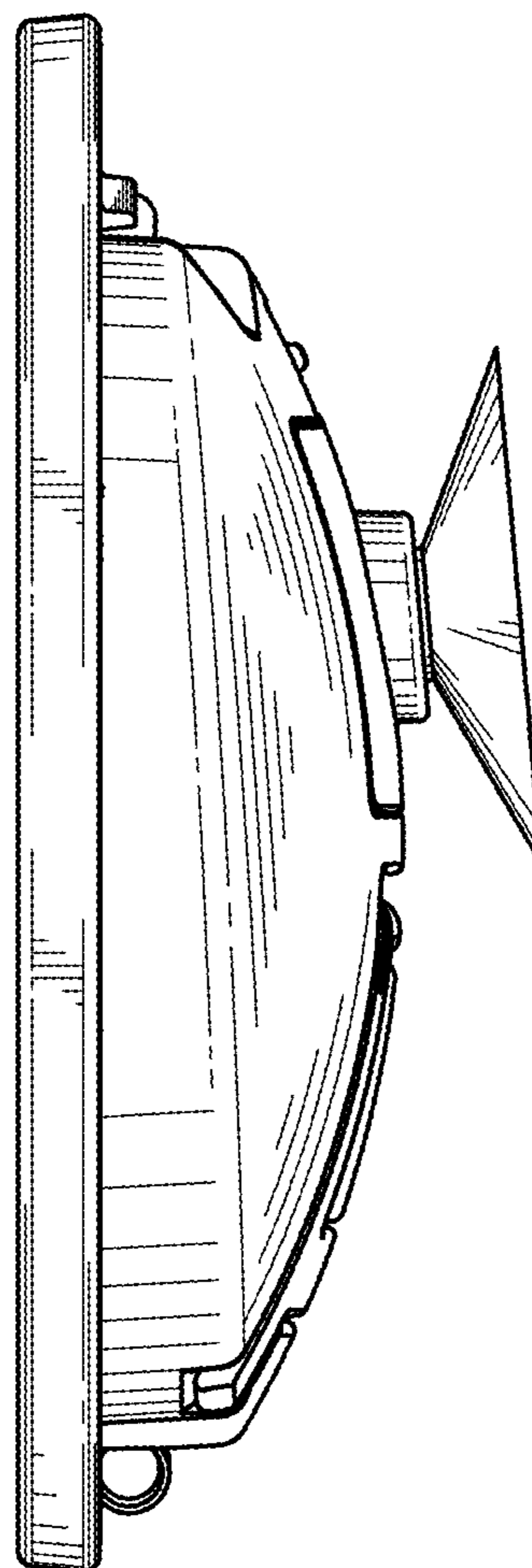

FIG. 8

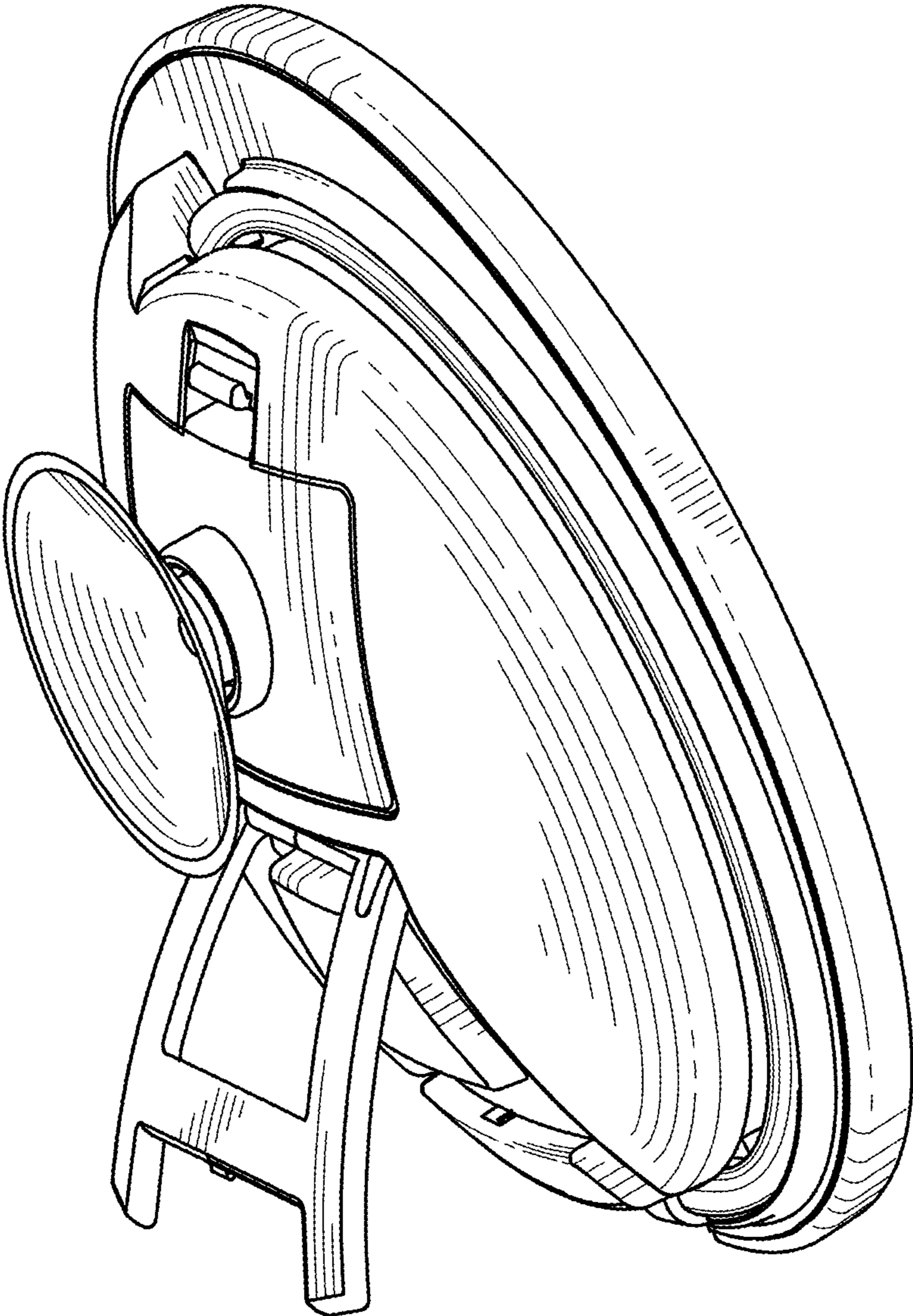

FIG. 9



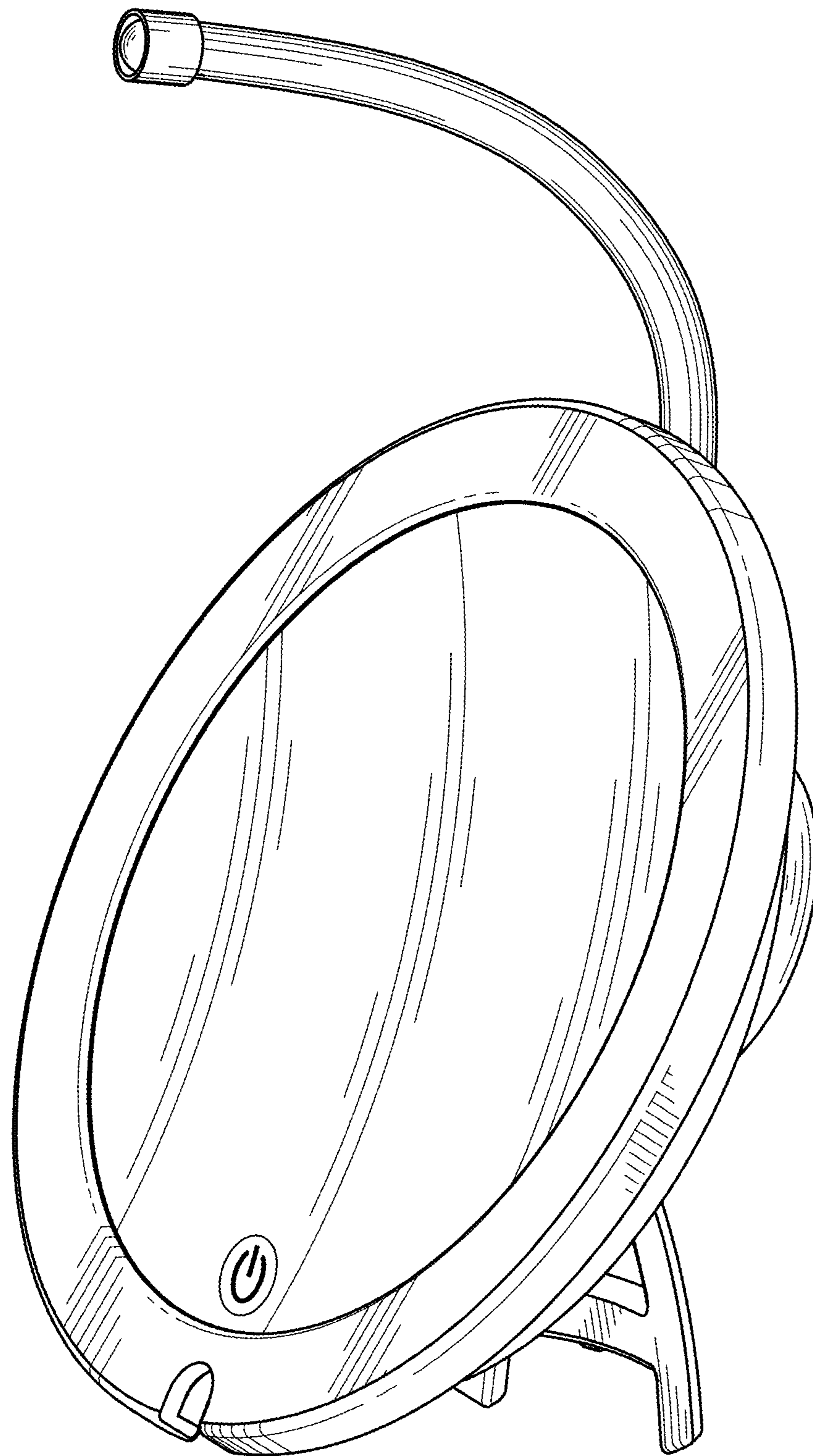

FIG. 10