



US00D932193S

(12) **United States Design Patent**
Salisbury et al.

(10) **Patent No.:** **US D932,193 S**

(45) **Date of Patent:** **** Oct. 5, 2021**

(54) **TOOTHBRUSH HEAD**

(71) Applicant: **GSK Consumer Healthcare S.A.**,
Prangins (CH)

(72) Inventors: **Daniel Salisbury**, Warwick (GB);
Joseph Butler, Warwick (GB); **Marcus**
Blachford, Warwick (GB); **Peter**
Fischbacher, Warwick (GB)

(73) Assignee: **GSK Consumer Healthcare, S.A.**,
Prangins (CH)

(**) Term: **15 Years**

(21) Appl. No.: **29/719,705**

(22) Filed: **Jan. 7, 2020**

(51) **LOC (13) Cl.** **28-03**

(52) **U.S. Cl.**
USPC **D4/111**

(58) **Field of Classification Search**
USPC D4/100, 101, 102, 104, 105, 106, 107,
D4/108, 109, 110, 111, 112, 113, 114,
D4/115, 116, 17, 118, 119, 120, 121, 127,
D4/128, 129, 130, 131, 132, 133, 134,
D4/135, 136, 137, 138, 199; D30/158
CPC A46B 2200/1066; A46B 5/02; A46B 9/04;
A46B 2200/1073; A46B 2200/1086;
A61C 17/22

See application file for complete search history.

(56) **References Cited**

U.S. PATENT DOCUMENTS

1,793,307 A * 2/1931 Dolan A47K 11/10
15/188
6,918,154 B2 * 7/2005 Ben-Ari A46B 7/06
15/167.1

D632,085 S * 2/2011 Kroehl D4/128
8,056,569 B2 * 11/2011 Berhault A46B 9/025
132/218
8,584,301 B2 * 11/2013 Maissami A46B 1/00
15/167.1
8,938,841 B1 * 1/2015 Ramirez A46B 9/045
15/106
D814,798 S * 4/2018 Ozimek D4/104
D814,799 S * 4/2018 Ozimek D4/104
D815,438 S * 4/2018 Ozimek D4/104

FOREIGN PATENT DOCUMENTS

CN 305846505 * 6/2020
EM 006615639-0001 * 1/2020

* cited by examiner

Primary Examiner — Karen E Eldridge Powers

(74) *Attorney, Agent, or Firm* — Roshni A. Sitapara

(57) **CLAIM**

The ornamental design for toothbrush head, as shown and described.

DESCRIPTION

FIG. 1 is a perspective view of toothbrush head;
FIG. 2 is a front elevation view thereof;
FIG. 3 is a rear elevation view thereof;
FIG. 4 is a right side elevation view thereof;
FIG. 5 is a left side elevation view thereof;
FIG. 6 is a top plan view thereof; and,
FIG. 7 is a bottom plan view thereof.
The broken lines shown in the drawings illustrate features of the article in which the design is embodied that form no part of the claim.

1 Claim, 7 Drawing Sheets

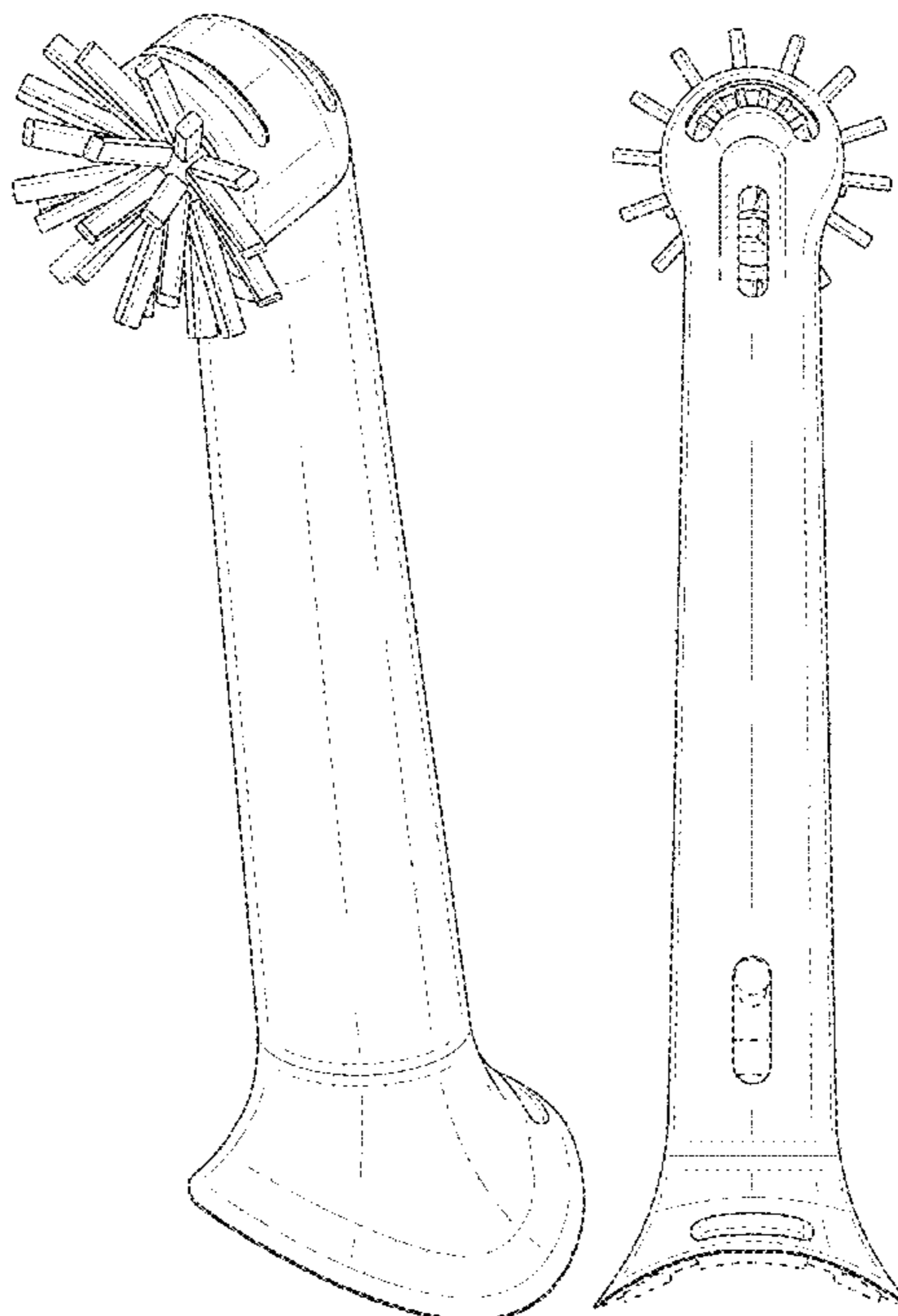

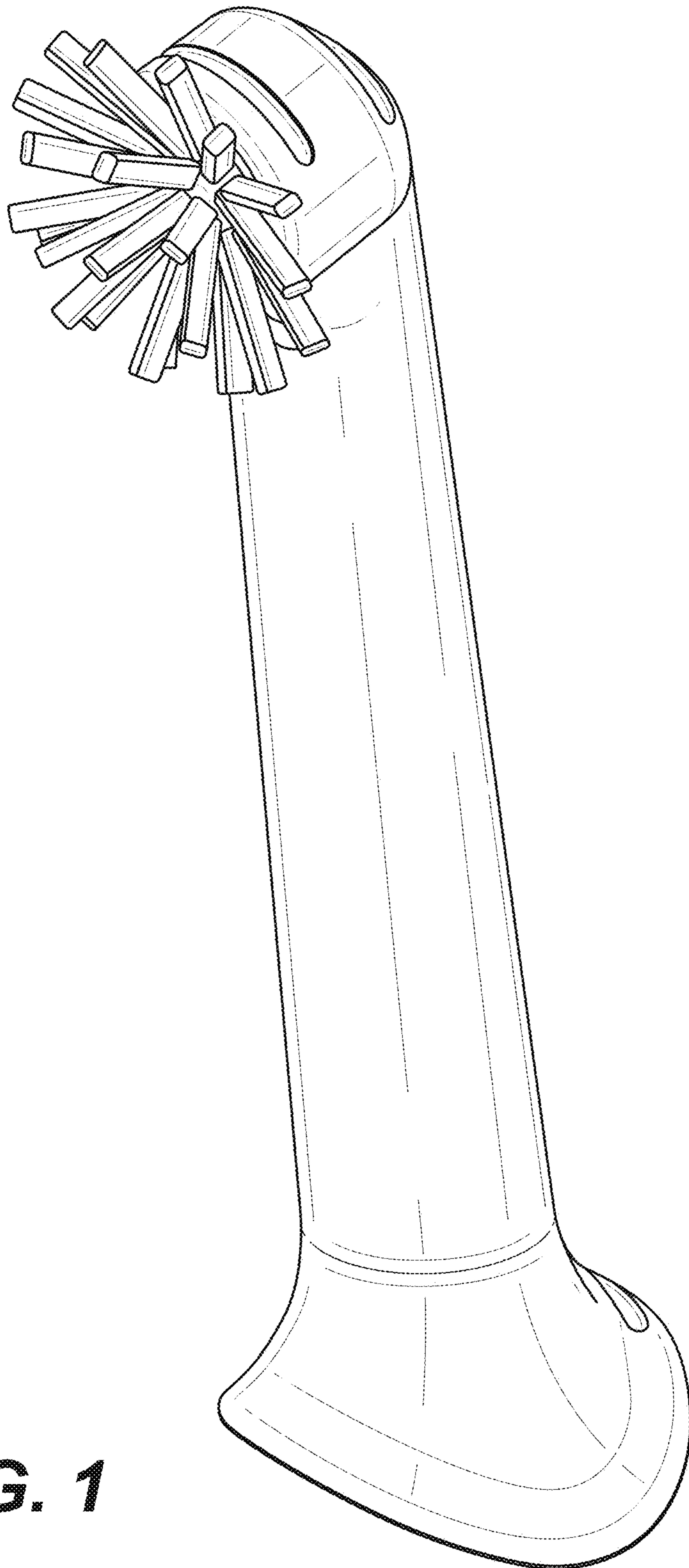

FIG. 1

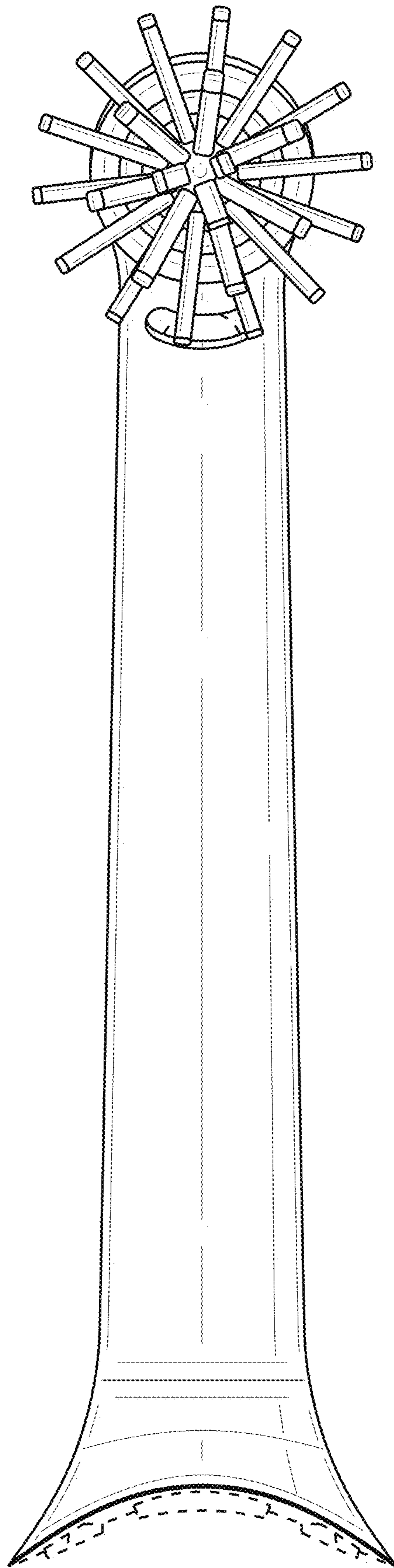

FIG. 2

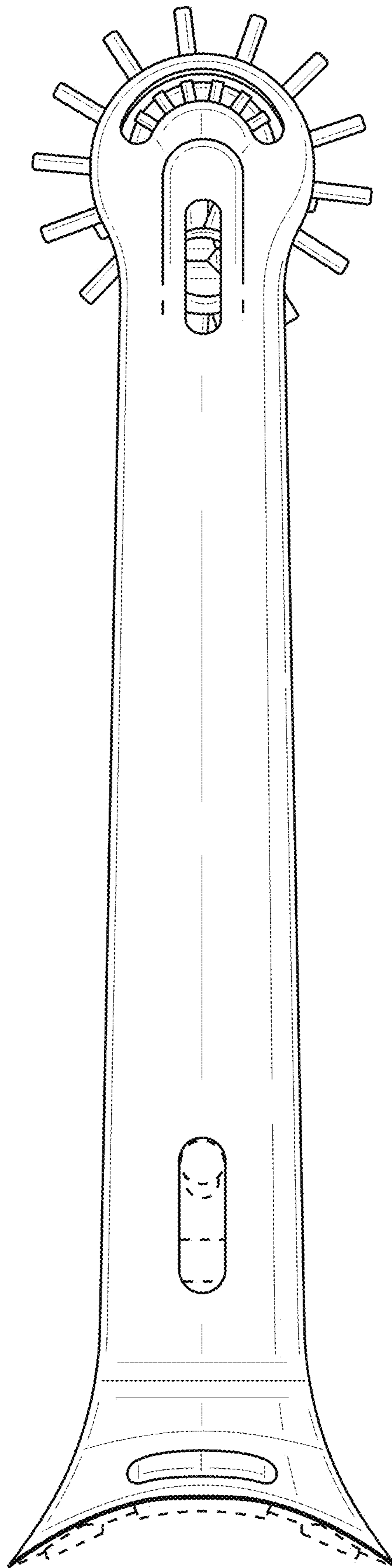

FIG. 3

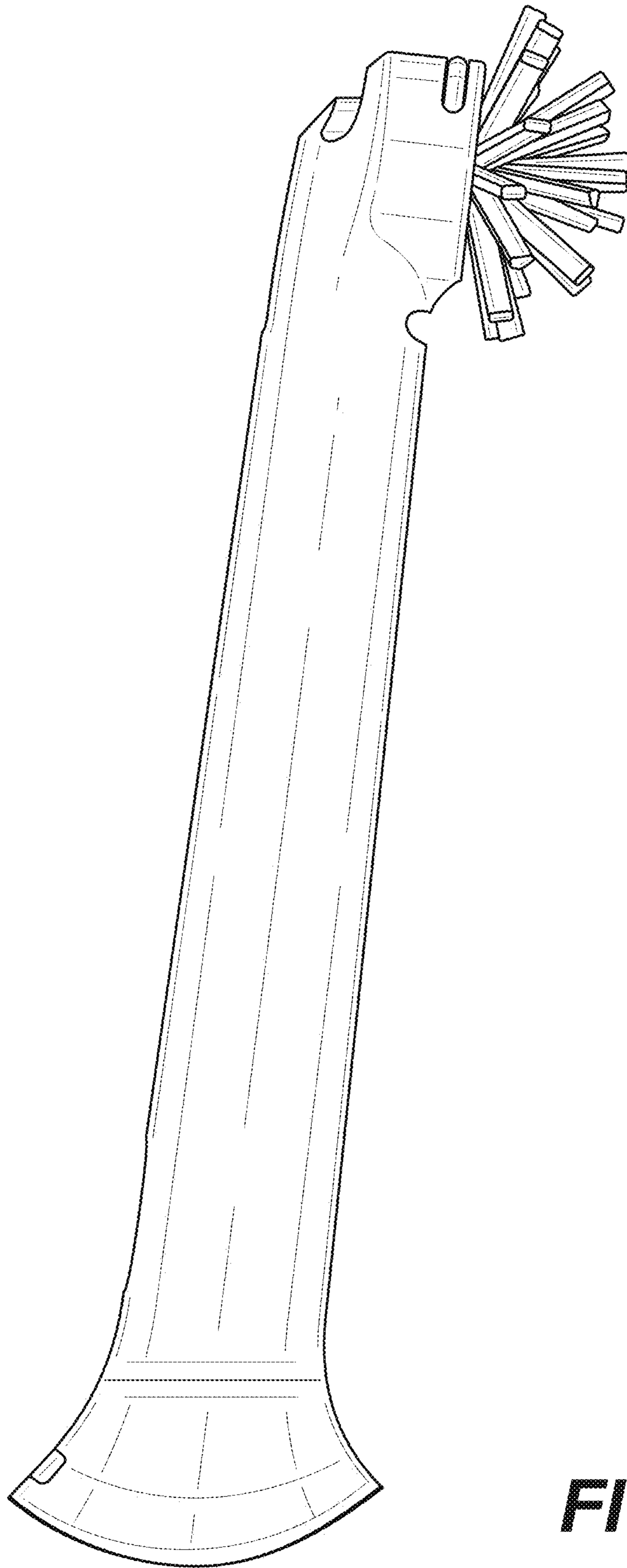

FIG. 4

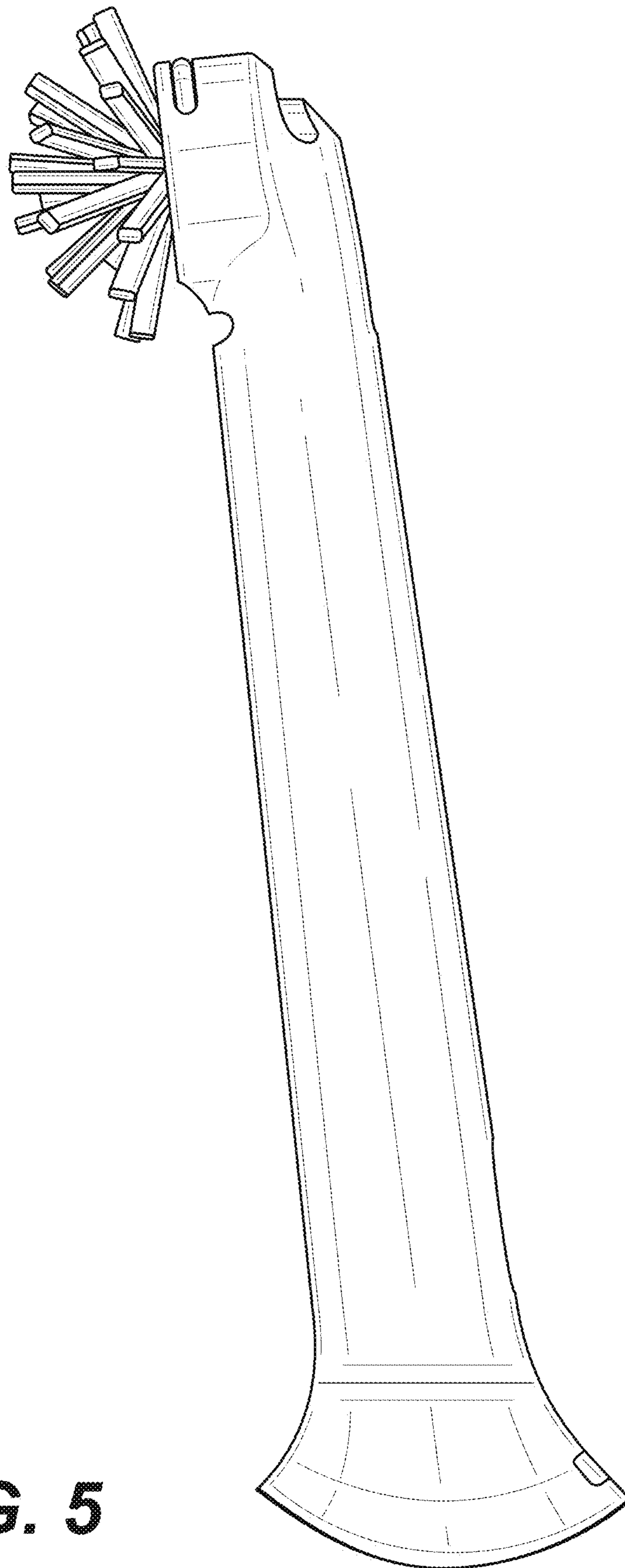

FIG. 5

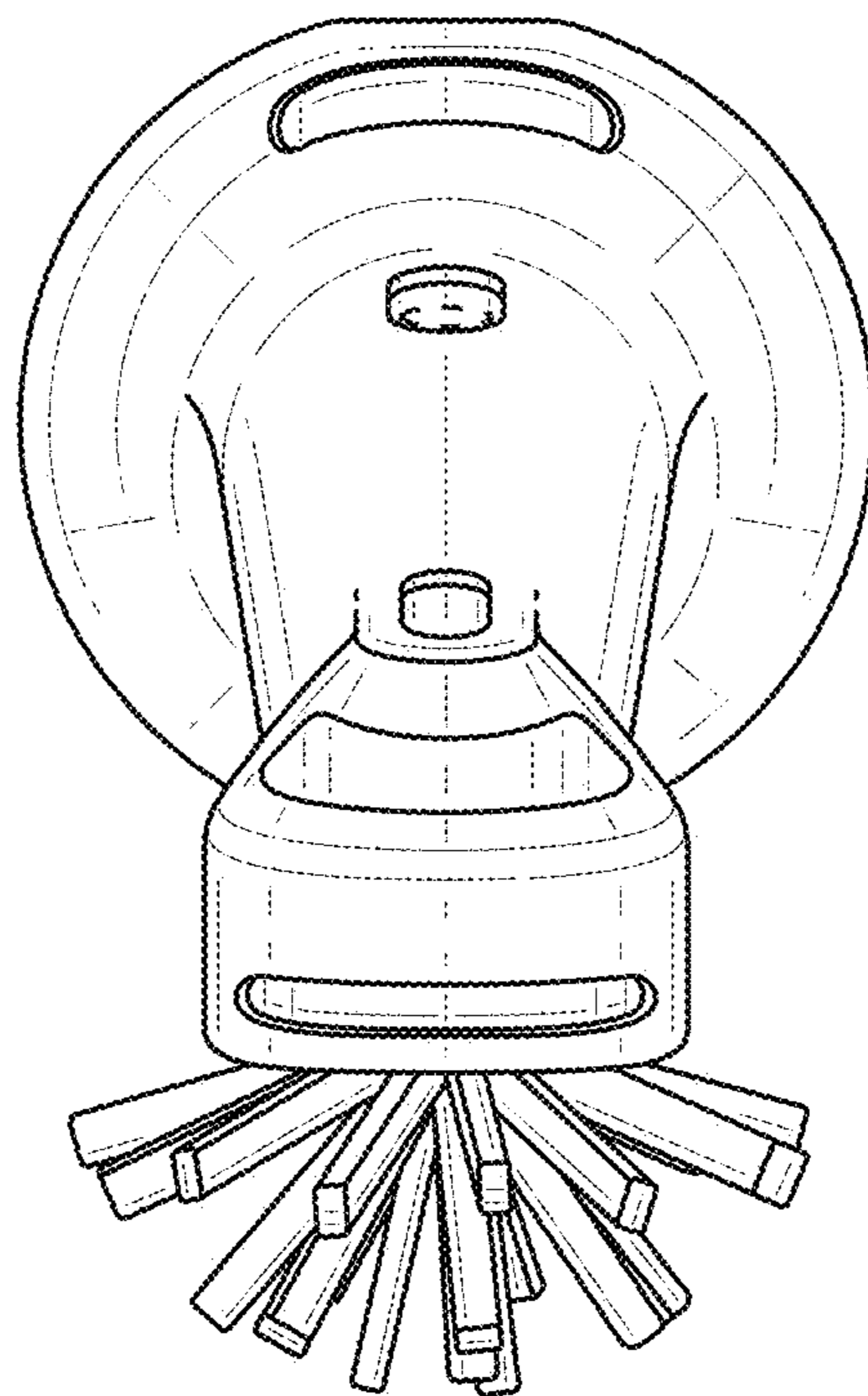

FIG. 6

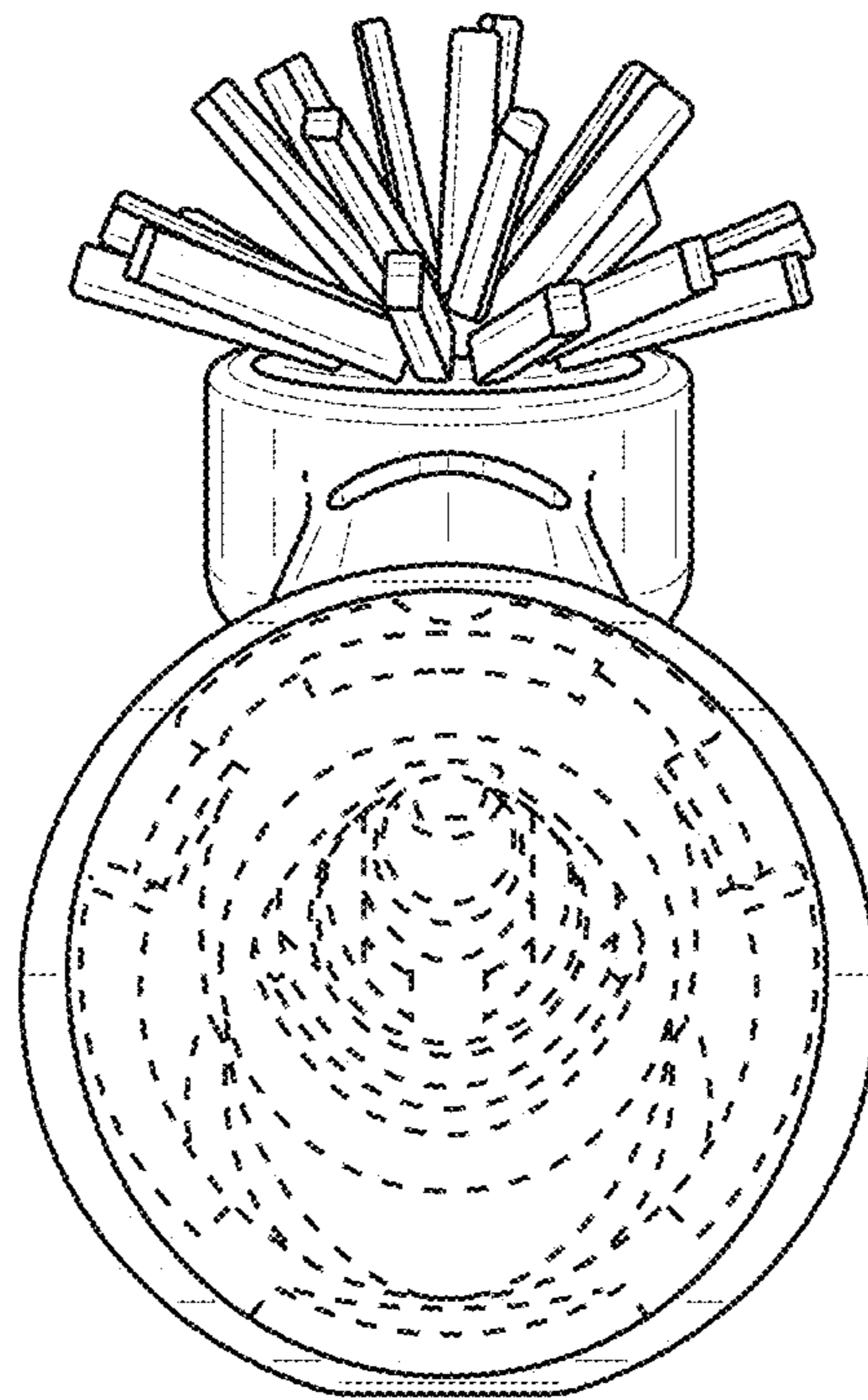

FIG. 7