



US00D932135S

(12) **United States Design Patent** (10) **Patent No.:** **US D932,135 S**  
**Ngan** (45) **Date of Patent:** **\*\* Oct. 5, 2021**

(54) **WEARABLE BLANKET**

FOREIGN PATENT DOCUMENTS

(71) Applicant: **Shun On John Ngan**, Carson, CA (US)

CA 2720578 11/2010  
CA 144154 11/2013

(72) Inventor: **Shun On John Ngan**, Carson, CA (US)

(Continued)

(\*\*) Term: **15 Years**

OTHER PUBLICATIONS

(21) Appl. No.: **29/748,787**

(22) Filed: **Sep. 1, 2020**

**Related U.S. Application Data**

(62) Division of application No. 29/729,444, filed on Mar. 26, 2020, now Pat. No. Des. 894,532.

(51) **LOC (13) Cl.** ..... **02-01**

(52) **U.S. Cl.**

USPC ..... **D2/719**

(58) **Field of Classification Search**

USPC ..... D2/719, 720, 728, 739, 741, 749-751, D2/758, 823-826, 840, 860; D6/603

CPC .. A41B 13/06; A41B 13/065; A41D 13/1209; A41D 13/1236; A41D 13/1281; A47G 9/083; A47G 9/0223; A47G 9/068

See application file for complete search history.

Open Road Goods; Open Road Goods Surf Poncho/Adult Hooded Towel/Changing Towel/Wetsuit Changing Robe/Swim Parka—Changing Poncho Charcoal Black/Indigo Blue; Saves a Sea Turtle’s Life; [https://www.amazon.com/Poncho-Adult-Hooded-Changing-Wetsuit/dp/B07BMR3KJ7/ref=sr\\_1\\_10?crd=2T0RU5Y9DSGSP&keywords=surf+poncho&qid=1576195319&sr=8-10](https://www.amazon.com/Poncho-Adult-Hooded-Changing-Wetsuit/dp/B07BMR3KJ7/ref=sr_1_10?crd=2T0RU5Y9DSGSP&keywords=surf+poncho&qid=1576195319&sr=8-10), 8 pages.

Koretamp Poncho Liner posted to bushcraftoutfitters.com. Available date Jul. 17, 2019 [site visited Mar. 20, 2020]. Available:< <https://bushcraftoutfitters.com/koretamp-poncho-liner/>> (Year: 2019).

(Continued)

*Primary Examiner* — Michelle E. Wilson

*Assistant Examiner* — Clese Moore, Jr.

(74) *Attorney, Agent, or Firm* — Cislo & Thomas, LLP

(57) **CLAIM**

The ornamental design for a wearable blanket, as shown and described.

(56) **References Cited**

**DESCRIPTION**

**U.S. PATENT DOCUMENTS**

1,097,530 A 5/1914 Cabelinsky  
1,243,206 A 10/1917 Norman  
1,432,249 A 10/1922 Robert  
1,643,440 A 9/1927 Baldwin  
1,905,235 A 4/1933 Mandelert  
D108,875 S 3/1938 Friedman  
D113,194 S 1/1939 Storey et al.  
2,143,931 A 1/1939 Aronson  
2,260,427 A 10/1941 Bailey  
2,292,347 A 8/1942 Bailey  
2,372,110 A 3/1945 Noone  
2,420,344 A 5/1947 Alexander  
2,865,025 A 12/1958 Hennessey  
2,873,449 A 2/1959 Herbert

(Continued)

FIG. 1 is a perspective view of my wearable blanket;

FIG. 2 is a front view thereof;

FIG. 3 is a rear view thereof;

FIG. 4 is a right side view thereof;

FIG. 5 is a left side view thereof;

FIG. 6 is a top view thereof; and,

FIG. 7 is a bottom view thereof.

The dash-dot-dash broken line portions of the disclosure are included for the purpose of illustrating environment and form no part of the claimed design.

The dash-dash broken lines shown in the drawings illustrate portions of my wearable blanket that form no part of the claimed design.

**1 Claim, 5 Drawing Sheets**

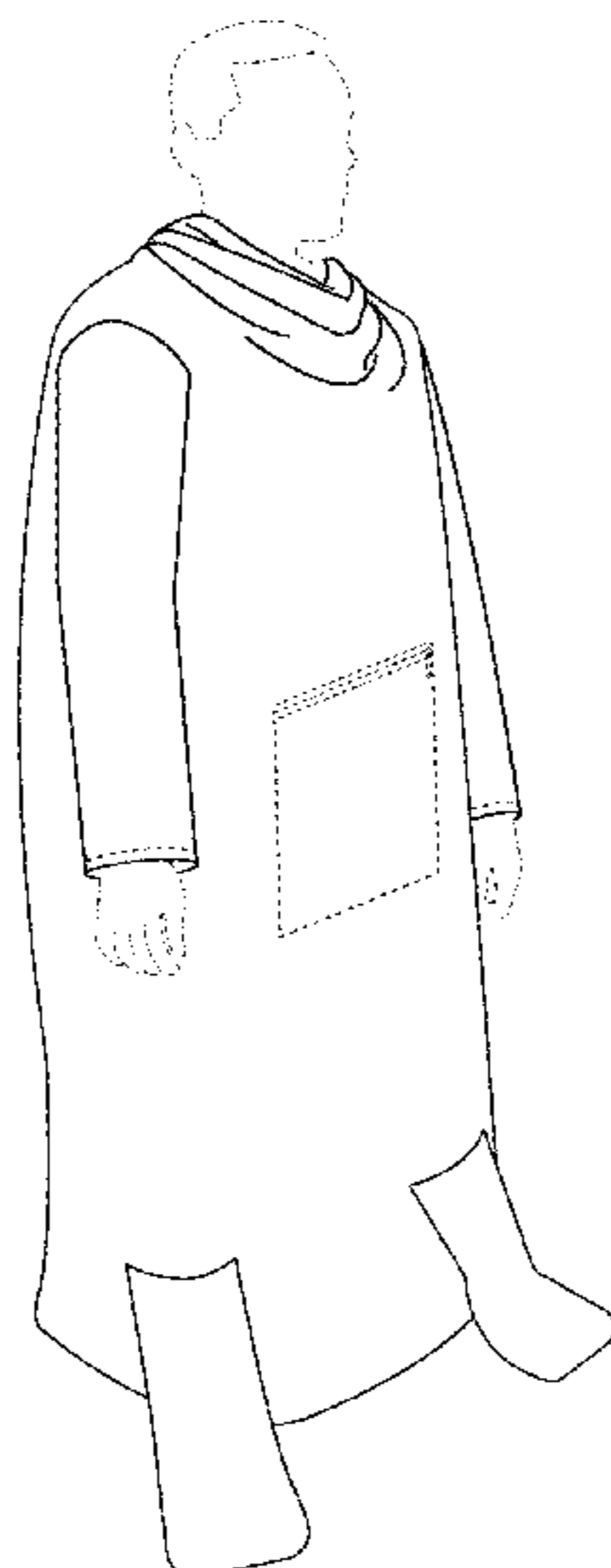

(56)

References Cited

U.S. PATENT DOCUMENTS

2,967,306 A	1/1961	Fabanich	7,684,755 B2	3/2010	Pierce
3,079,611 A	3/1963	Boryszewski	D626,310 S	11/2010	Cruz
D196,096 S	8/1963	Griffith et al.	D626,720 S	11/2010	Pinkhasov
3,116,491 A	1/1964	Previdi et al.	D626,725 S	11/2010	Snyder et al.
3,381,306 A	5/1968	Innes	D627,540 S	11/2010	Claeys
D225,489 S	12/1972	Graham	D629,590 S	12/2010	Freedman et al.
3,797,043 A	3/1974	Brument	D630,002 S	1/2011	Brown
3,837,006 A	9/1974	Laseman	D630,003 S	1/2011	Brown
4,055,853 A	11/1977	Argento et al.	D630,820 S	1/2011	Wilson
D247,331 S	2/1978	Nally	D636,973 S	5/2011	Smith et al.
D247,526 S	3/1978	Nally	D638,612 S	5/2011	Benderradji
4,078,264 A	3/1978	DeGennaro	D645,645 S	9/2011	Dyer
4,227,264 A	10/1980	Spector et al.	D648,923 S	11/2011	Morales
4,370,755 A	2/1983	Crumby	D653,836 S	2/2012	Woyshner et al.
4,404,687 A	9/1983	Hager	D663,105 S	7/2012	Selivon
4,502,155 A	3/1985	Itoi	D672,531 S	12/2012	Kelfer
D294,535 S	3/1988	Stricklin	D674,167 S	1/2013	Ehler
D296,605 S	7/1988	Asher	D677,859 S	3/2013	Andes
4,791,681 A	12/1988	Dean	D677,860 S	3/2013	Kim
4,862,519 A	9/1989	Bull	D679,479 S	4/2013	Carrera et al.
4,928,321 A	5/1990	Dobson	D679,484 S	4/2013	Brown
D312,721 S	12/1990	Shea	8,424,113 B2	4/2013	Sprole
5,086,516 A	2/1992	Baxter et al.	8,424,114 B2	4/2013	Snyder et al.
D325,459 S	4/1992	Keever	D683,523 S	6/2013	Freedman
5,119,510 A	6/1992	Schilling	D684,341 S	6/2013	Freedman
5,206,957 A	5/1993	Gulick	D684,409 S	6/2013	Juarez
D351,712 S	10/1994	Jackson	D685,158 S	7/2013	Lambertz
D360,517 S	7/1995	Reizenstein	D686,408 S	7/2013	Sternlight et al.
D365,193 S	12/1995	Dodd, Jr.	D687,210 S	8/2013	Krafnick
D385,088 S	10/1997	Handysides	D687,619 S	8/2013	Savage
5,697,102 A	12/1997	Benjamin	D690,078 S	9/2013	Anderson
5,720,043 A	2/1998	White, Sr.	D690,486 S	10/2013	Yan
5,787,504 A	8/1998	Wu	D692,212 S	10/2013	Coward
5,850,634 A	12/1998	Toombs	8,566,963 B2	10/2013	Ryan
D414,013 S	9/1999	Group	D693,540 S	11/2013	Vanneste
5,996,121 A	12/1999	Harris	D693,541 S	11/2013	Vanneste
6,006,356 A	12/1999	Song	8,578,515 B1	11/2013	Petersen
6,014,772 A	1/2000	Connelly	D700,418 S	3/2014	Borovicka et al.
D430,721 S	9/2000	Beauchan	D701,368 S	3/2014	Borovicka et al.
6,185,743 B1	2/2001	Mick	D701,369 S	3/2014	Borovicka et al.
D439,029 S	3/2001	Goldman	D701,677 S	4/2014	Tref
6,219,847 B1	4/2001	Aikins	D704,924 S	5/2014	Roberts et al.
6,253,381 B1	7/2001	Kelley	D707,466 S	6/2014	Landcaster
6,275,993 B1	8/2001	McCarley	D708,423 S	7/2014	Adams et al.
D453,607 S	2/2002	Tracy	D714,021 S	9/2014	Bowen
6,397,395 B1	6/2002	DeHart	D714,524 S	10/2014	Borovicka
6,405,377 B1	6/2002	Davis	D714,527 S	10/2014	Borovicka
D465,317 S	11/2002	Darling	8,864,544 B2	10/2014	Anderman et al.
D478,708 S	8/2003	Miros et al.	D721,467 S	1/2015	Tref
D482,935 S	12/2003	Yamane	8,942,403 B2	1/2015	Oman et al.
6,760,921 B1	7/2004	Simmons	D721,870 S *	2/2015	Levine ..... D2/720
D496,144 S	9/2004	Bourget	D728,900 S	5/2015	White
6,839,911 B1	1/2005	Mathews	D732,799 S	6/2015	Smith
6,848,118 B2	2/2005	Barnes et al.	D732,800 S	6/2015	Brown
6,859,942 B1 *	3/2005	Cratty ..... A41D 3/08 2/88	9,060,555 B1	6/2015	Harris et al.
D507,693 S	7/2005	Walton	D736,496 S	8/2015	Gonzalez
6,922,848 B1	8/2005	Stanley	D741,567 S	10/2015	Chang
7,065,810 B2	6/2006	Robinson	D741,576 S	10/2015	Sakosits
D539,508 S	4/2007	Rogers et al.	D746,550 S	1/2016	Roberts et al.
D541,011 S	4/2007	Day et al.	D746,551 S	1/2016	Ingram
D543,011 S	5/2007	Waite	D747,075 S	1/2016	Ingram
D551,429 S	9/2007	Wager	D751,272 S	3/2016	Moehring
D553,329 S	10/2007	Wager	9,295,292 B2	3/2016	Sachs
D553,330 S	10/2007	Wager	D754,947 S	5/2016	Borovicka
D565,456 S	4/2008	Anderson et al.	9,339,064 B2	5/2016	Oliver
7,418,740 B2	9/2008	Anderson et al.	D758,046 S	6/2016	Grant
D584,482 S	1/2009	Marsh	D758,700 S	6/2016	Borovicka
D590,133 S	4/2009	Rogondino	D762,345 S	8/2016	Adams et al.
D591,028 S	4/2009	Rogondino	9,414,631 B2	8/2016	Schrimpf
D594,633 S	6/2009	Floyd	D765,349 S	9/2016	Hou
D600,884 S	9/2009	Patton	D765,351 S	9/2016	Shaw
D601,327 S	10/2009	Anderson et al.	D767,255 S	9/2016	Marino
D608,983 S	2/2010	Myers	D769,580 S	10/2016	Conway et al.
D609,432 S	2/2010	Jennings	D770,136 S	11/2016	Darmour
			9,521,873 B1	12/2016	Mignone
			9,554,601 B2	1/2017	Arajakis
			D784,659 S	4/2017	Darmour
			D785,285 S	5/2017	Shamsid-Deen
			D785,906 S	5/2017	Darmour



(56)

References Cited

FOREIGN PATENT DOCUMENTS

DE	202013009697	U1	2/2013
DE	202014002960	U1	7/2014
DE	202014002963	U1	7/2014
DE	202015009314	U1	9/2015
DM	011283		7/1988
DM	082169		11/2013
DM	091998		10/2016
EM	000828017		9/2016
EM	000875893		9/2016
EM	000891759		9/2016
EM	001220461		9/2016
EM	001378590		9/2016
EM	001426902		9/2016
EM	001676404		9/2016
EM	002237149		9/2016
EM	002441386		9/2016
EM	002804310		9/2016
EM	002978601		9/2016
EM	003126481		9/2016
EM	003619766		9/2016
EM	004173367		9/2016
GB	2551262		12/2017
JP	1046408		2/1998
JP	2006207103		8/2006
JP	2008511767	A	4/2008
KR	102110083	B1	4/2008
KR	20190110979	A	10/2019
NL	9302143		7/1995
PL	20025	S2	4/2013
WO	WO 2018222868		6/2018
WO	2020023161	A1	1/2020

OTHER PUBLICATIONS

Ho Stevie! Surf Poncho posted to amazon.com. Available date: Mar. 19, 2016 [site visited Mar. 20, 2020]. Available <[https://www.amazon.com/Ho-Stevie-Microfiber-Wetsuit-Changing/dp/B01CV1P9UG/ref=cm\\_cr\\_arp\\_d\\_product\\_top?ie=UTF8](https://www.amazon.com/Ho-Stevie-Microfiber-Wetsuit-Changing/dp/B01CV1P9UG/ref=cm_cr_arp_d_product_top?ie=UTF8)> (Year: 2016).  
 The Comfy Original, posted 2018 [online], (retrieved Oct. 14, 2020), Retrieved from the internet, <https://www.amazon.com/Comfy-Sweatshirt-Comfortable-Originally-Featured/dp/B07DKTDBWC?th=1> (Year: 2018).  
 Unicorn Oversized Share Sherpa Hoodie Blanket Sweatshirt, posted early as Dec. 23, 2018 [online], (retrieved Jun. 14, 2021). Retrieved from the internet, <https://www.amazon.com/Catalonia-Oversized-Sweatshirt-Comfortable-Teenagers/dp/B07Z4PT3Q7?th=1> (Year: 2018).  
 Panda Oversized Share Sherpa Hoodie Blanket, posted early as Dec. 23, 2018 [online], (retrieved Jun. 14, 2021), Retrieved from the internet, <https://www.amazon.com/Catalonia-Oversized-Sweatshirt-Comfortable-Teenagers/dp/B07Z4QHGTP?th=1> (Year: 2018).  
 Bear Oversized Share Sherpa Hoodie Blanket Sweatshirt, posted early as Dec. 23, 2018 [online], (retrieved Jun. 14, 2021), Retrieved from the internet, <https://www.amazon.com/Catalonia-Oversized-Sweatshirt-Comfortable-Teenagers/dp/B07XDPH9FG?th=1th=1> (Year: 2018).  
 Cat Oversized Share Sherpa Hoodie Blanket Sweatshirt, posted early as Dec. 23, 2018 [online], (retrieved Jun. 14, 2021). Retrieved from the internet, <https://www.amazon.com/Catalonia-Oversized-Sweatshirt-Comfortable-Teenagers/dp/B07Z4LVS1Q?th=1> (Year: 2018).  
 Giftsmate Batman Hoodie Sweatshirt with Kangaroo Pocket, <https://www.amazon.in/Giftsmate-Batman-Hoodie-sweatshirt-Kangaroo/dp/B0177ZCHFQ>, 4 pages.

\* cited by examiner

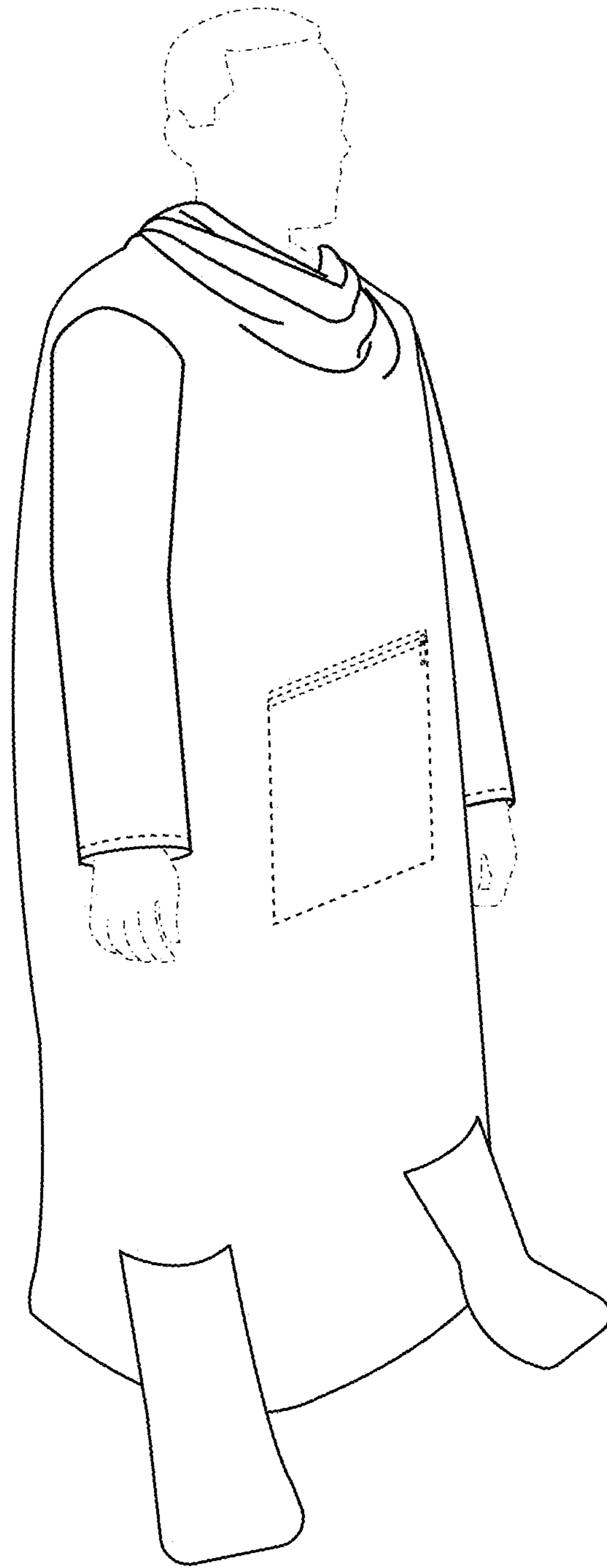

Fig. 1

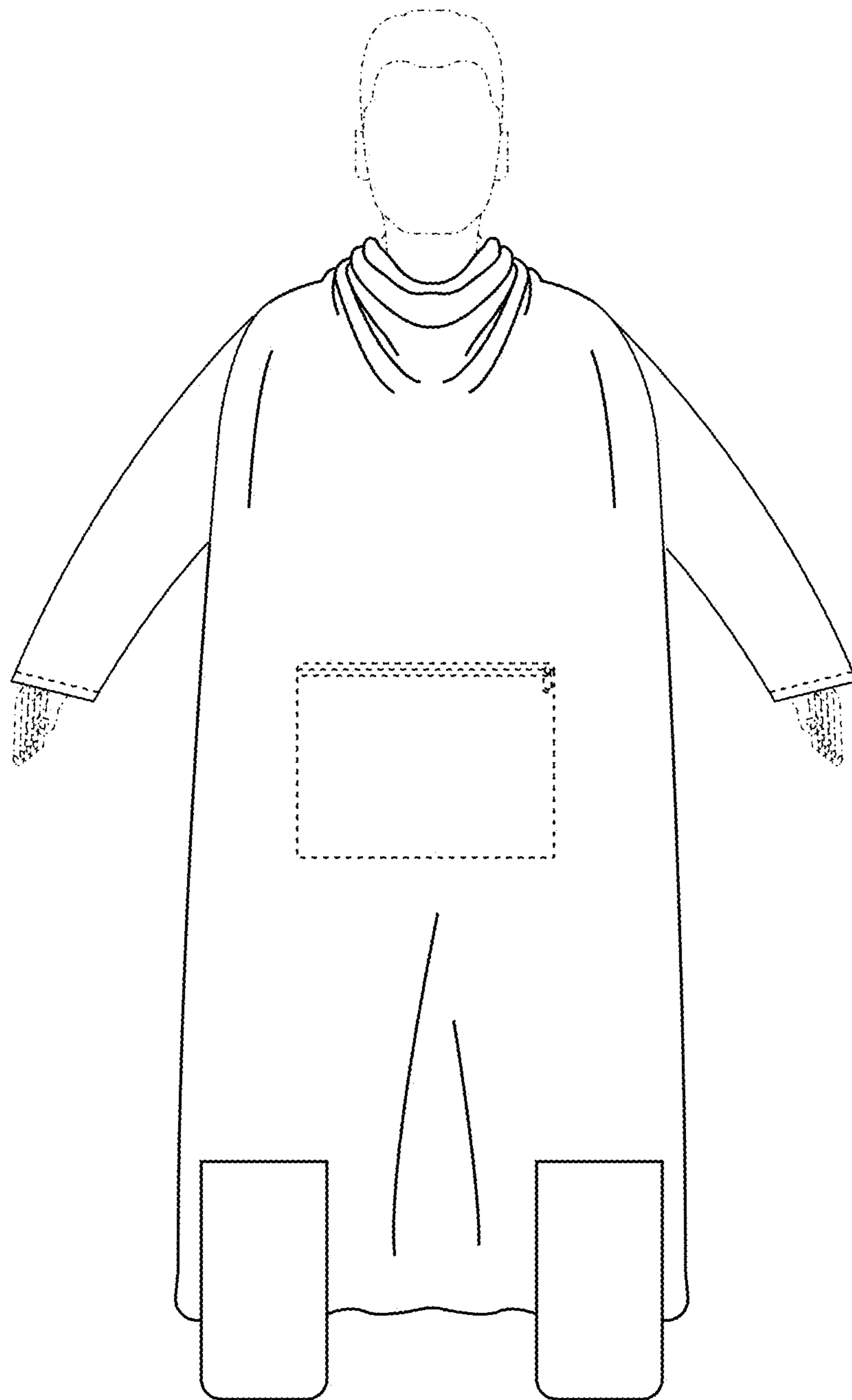

Fig. 2

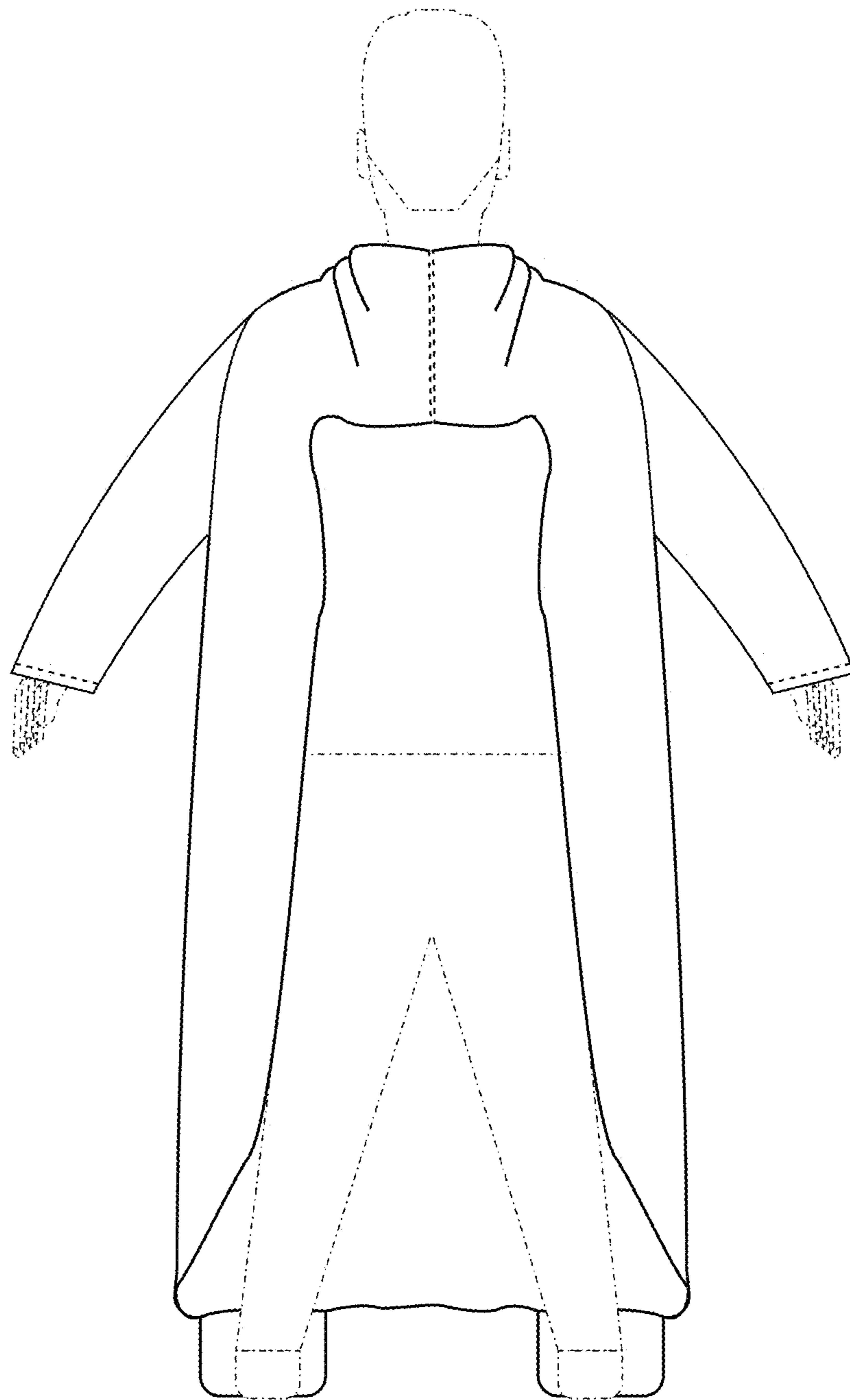

Fig. 3

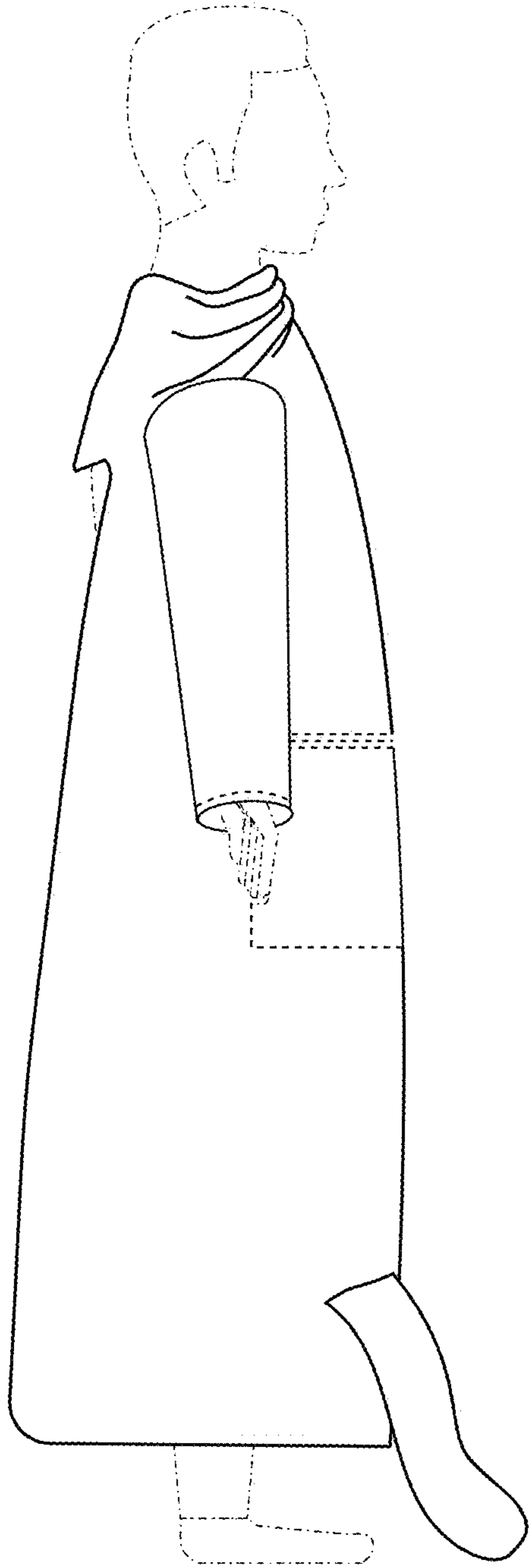

Fig. 4

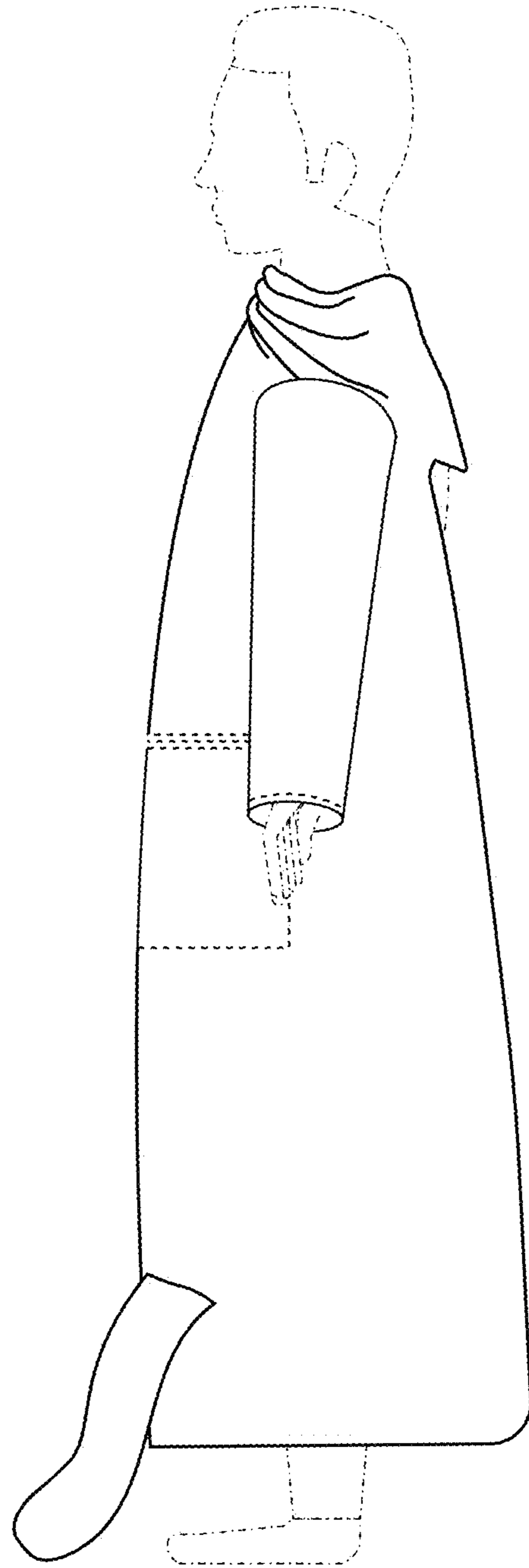

Fig. 5



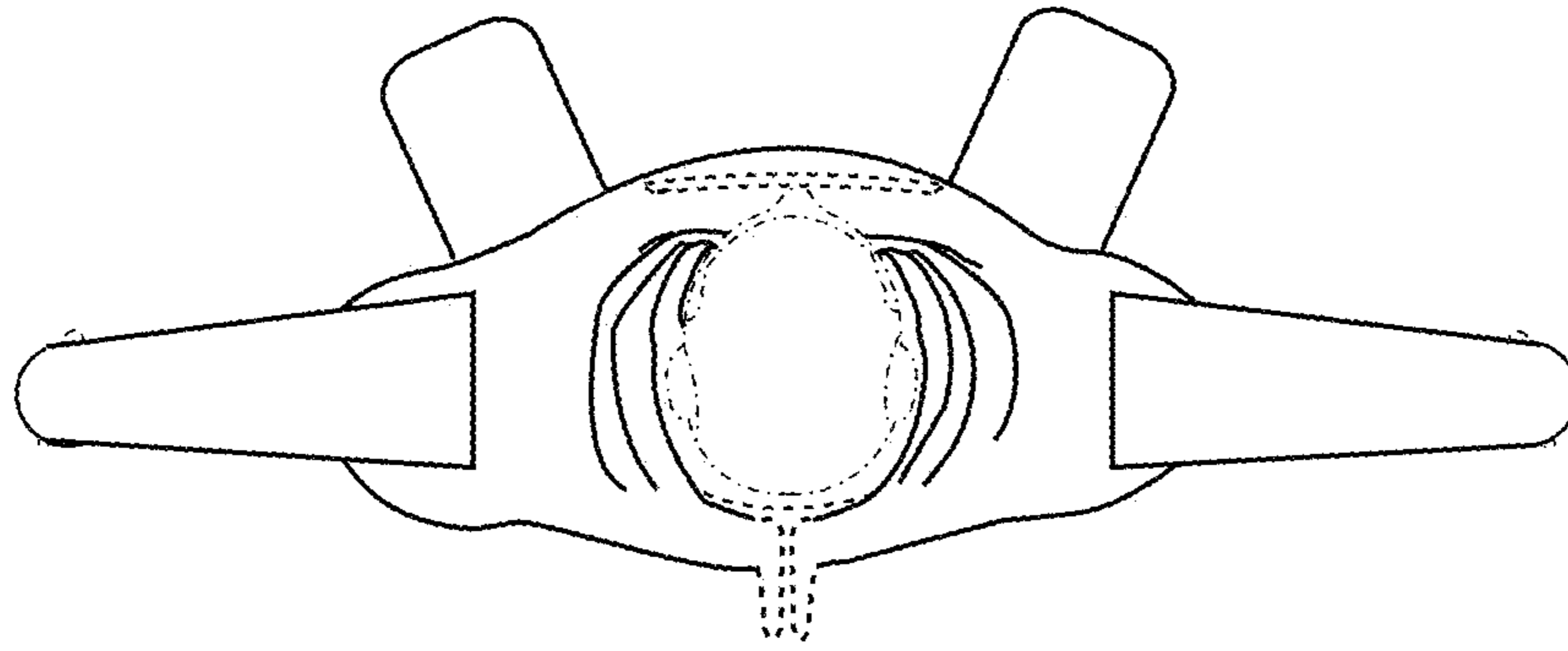

Fig. 6

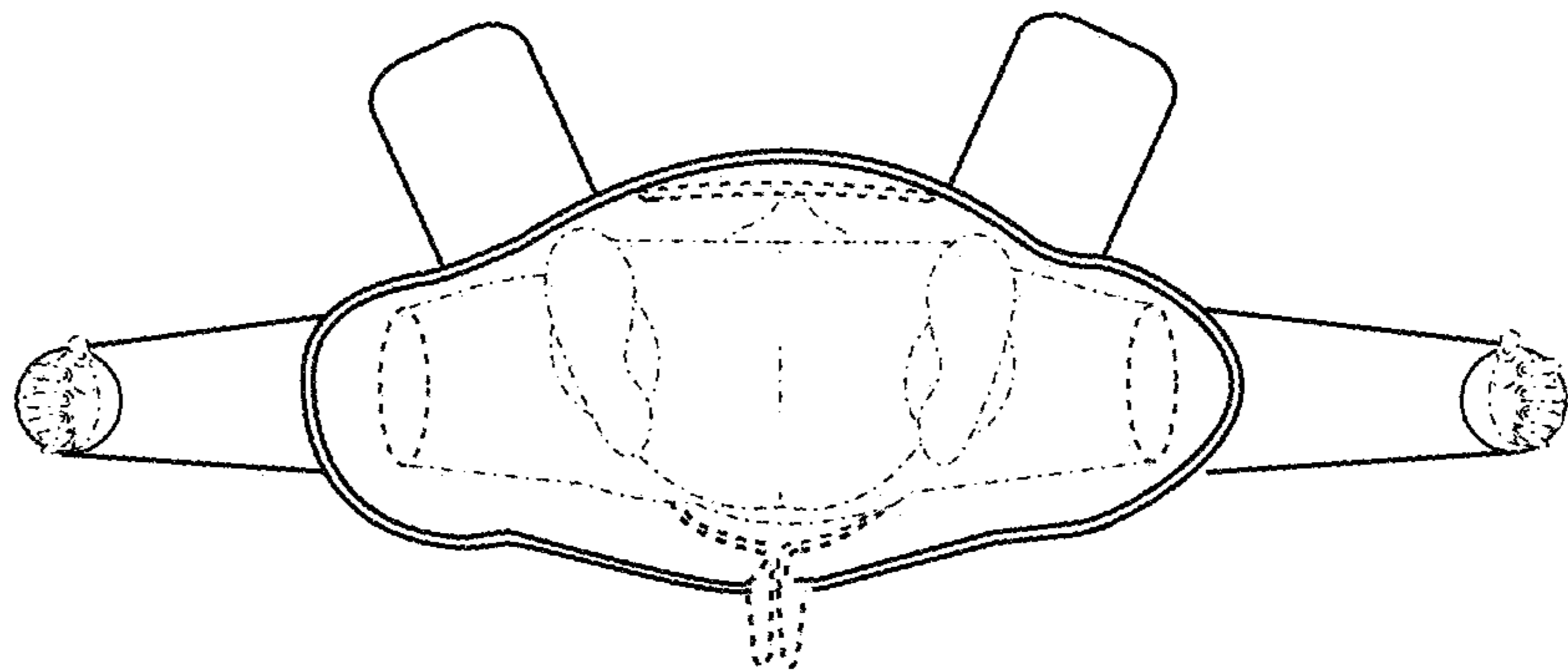

Fig. 7