



US00D932120S

(12) **United States Design Patent** (10) **Patent No.:** **US D932,120 S**
Xu (45) **Date of Patent:** **** Sep. 28, 2021**

(54) **PRESSURE WASHER**
(71) Applicant: **NingBo JiaSheng Power Tools Co., Ltd.**, NingBo (CN)
(72) Inventor: **RongDing Xu**, NingBo (CN)
(73) Assignee: **NINGBO JIASHENG POWER TOOLS CO., LTD.**, Ningbo (CN)

D739,099 S * 9/2015 Tatic D32/15
D739,100 S * 9/2015 Tatic D32/15
D743,643 S * 11/2015 Casey D32/15
D778,011 S * 1/2017 Alexander D32/16
D781,511 S * 3/2017 Meyer D32/16
D824,612 S * 7/2018 Alexander D32/16
D824,613 S * 7/2018 Alexander D32/16

(Continued)

(**) Term: **15 Years**
(21) Appl. No.: **29/658,206**

WO WO D095758-001 * 4/2017

FOREIGN PATENT DOCUMENTS

(22) Filed: **Jul. 30, 2018**
(51) **LOC (13) Cl.** **15-05**
(52) **U.S. Cl.**
USPC **D32/15**
(58) **Field of Classification Search**
USPC D32/15-19, 50-52, 43; D8/70
CPC E04D 13/0765; A01G 20/47; A47L 11/30;
A47L 11/4066; A47L 11/4002; A47L
11/4011
See application file for complete search history.

OTHER PUBLICATIONS

Domestic high pressure washer-lutian, Alibaba website 2019, https://nbmingou.en.alibaba.com/product/60701008643-805482528/Domestic_high_press... site visited Nov. 25, 2019.*

(Continued)

Primary Examiner — John R Yeh
(74) *Attorney, Agent, or Firm* — Law Offices of Steven W. Weinrieb

(56) **References Cited**

(57) **CLAIM**

The ornamental design for a pressure washer, as shown and described.

U.S. PATENT DOCUMENTS

DESCRIPTION

4,432,472 A * 2/1984 Lamm A47L 11/1625
15/246
D496,503 S * 9/2004 Chen D32/16
D536,848 S * 2/2007 Shin D32/18
D556,959 S * 12/2007 Li D32/15
D559,481 S * 1/2008 Renner D32/15
D563,612 S * 3/2008 Li D32/15
D564,147 S * 3/2008 Li D32/15
D576,703 S * 9/2008 Nathan D23/225
D647,672 S * 10/2011 Alexander D32/15
D648,081 S * 11/2011 Alexander D32/15
D649,308 S * 11/2011 Alexander D32/15
D660,525 S * 5/2012 Alexander D32/15
D696,824 S * 12/2013 Dammkoehler D32/15
8,719,998 B1 * 5/2014 Huffman A47L 11/34
15/319

FIG. 1 is a first perspective view of a pressure washer showing the claimed new design;
FIG. 2 is a second perspective view thereof;
FIG. 3 is a front elevational view thereof;
FIG. 4 is a rear elevational view thereof;
FIG. 5 is a left side elevational view thereof;
FIG. 6 is a right side elevational view thereof;
FIG. 7 is a top plane view thereof; and,
FIG. 8 is a bottom plane view thereof.
The broken lines in the figures illustrate portions of the pressure washer which form no part of the claimed design.

1 Claim, 8 Drawing Sheets

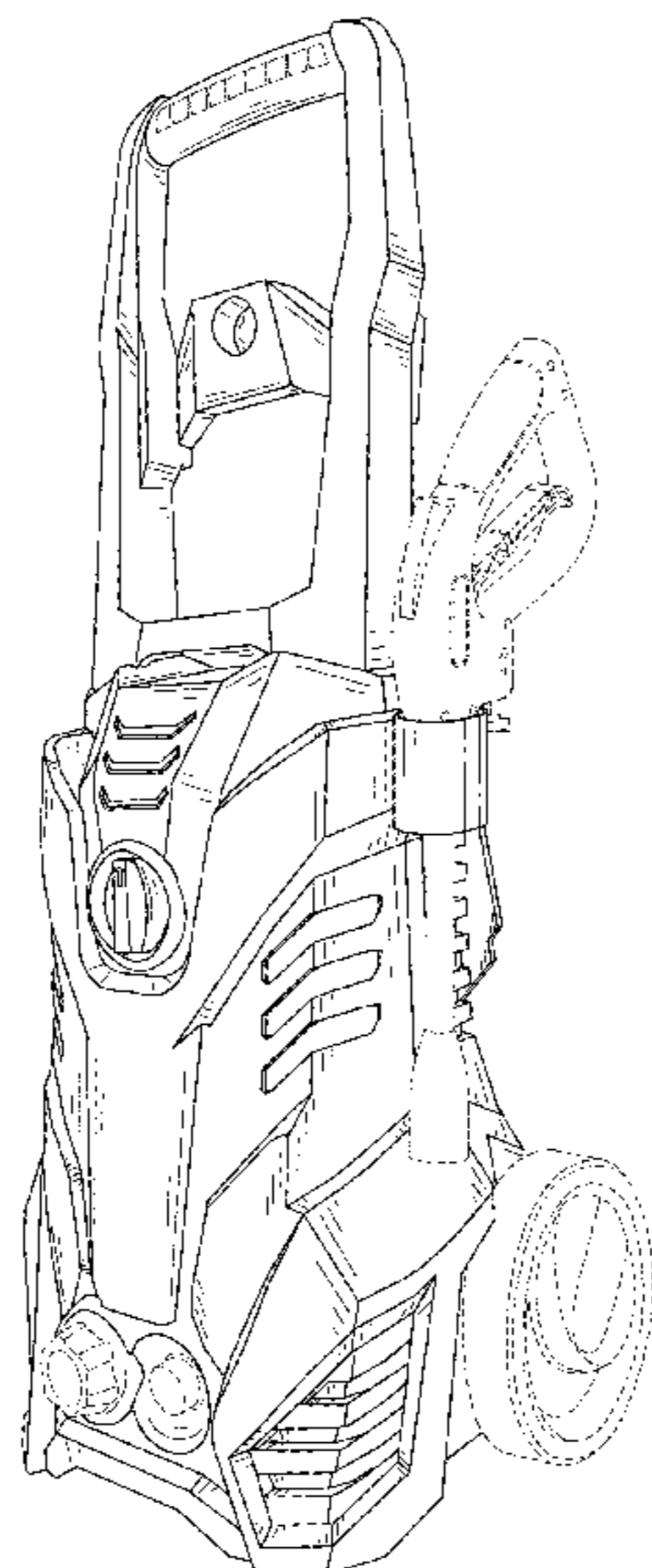

(56)

References Cited

U.S. PATENT DOCUMENTS

D838,926 S * 1/2019 Delgado D32/16
D841,906 S * 2/2019 Weinberg D32/16
2015/0245758 A1* 9/2015 Wall A47L 11/4088
15/320

OTHER PUBLICATIONS

Tolhit 110v 240v 1500w 120bar Home Garden Jet Cleaner, Alibaba website 2020, https://www.alibaba.com/product-detail/TOLHIT-110v-240v-1500w-120bar-Home_60745 . . . site visited May 19, 2020.*

* cited by examiner

FIG. 1

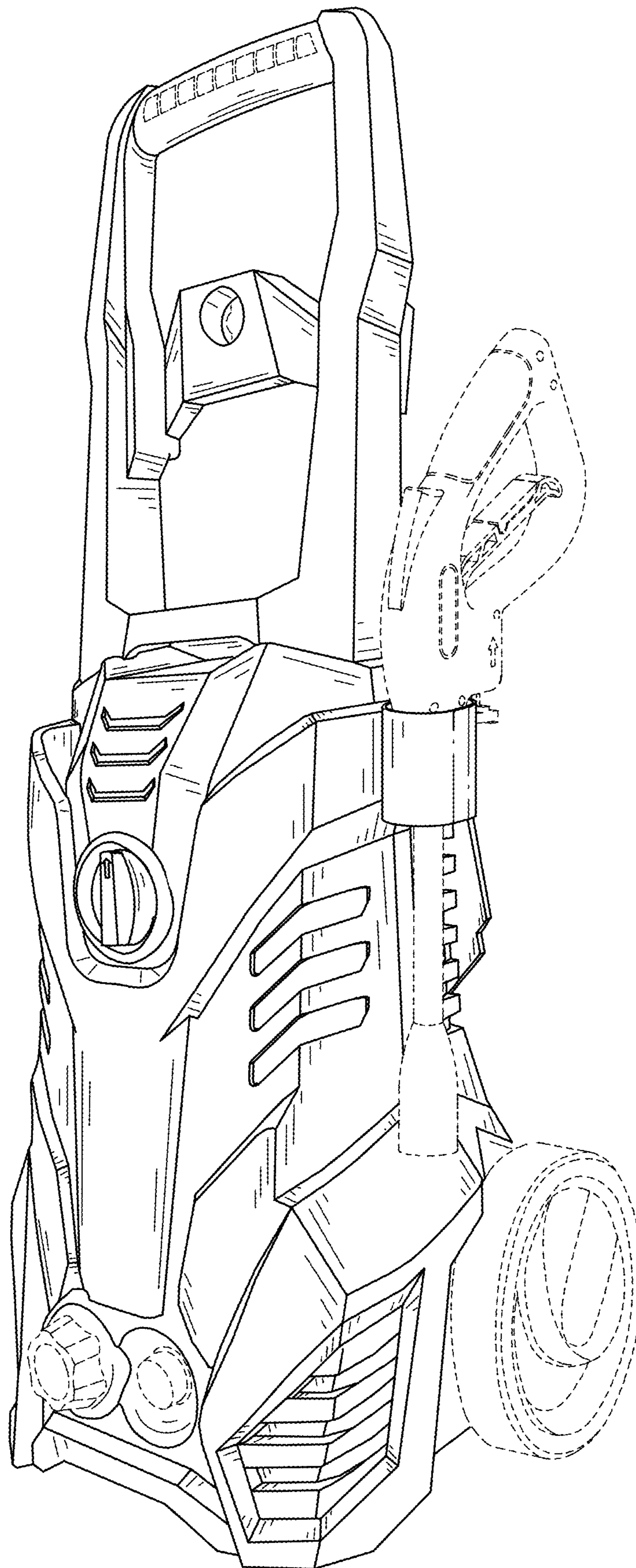

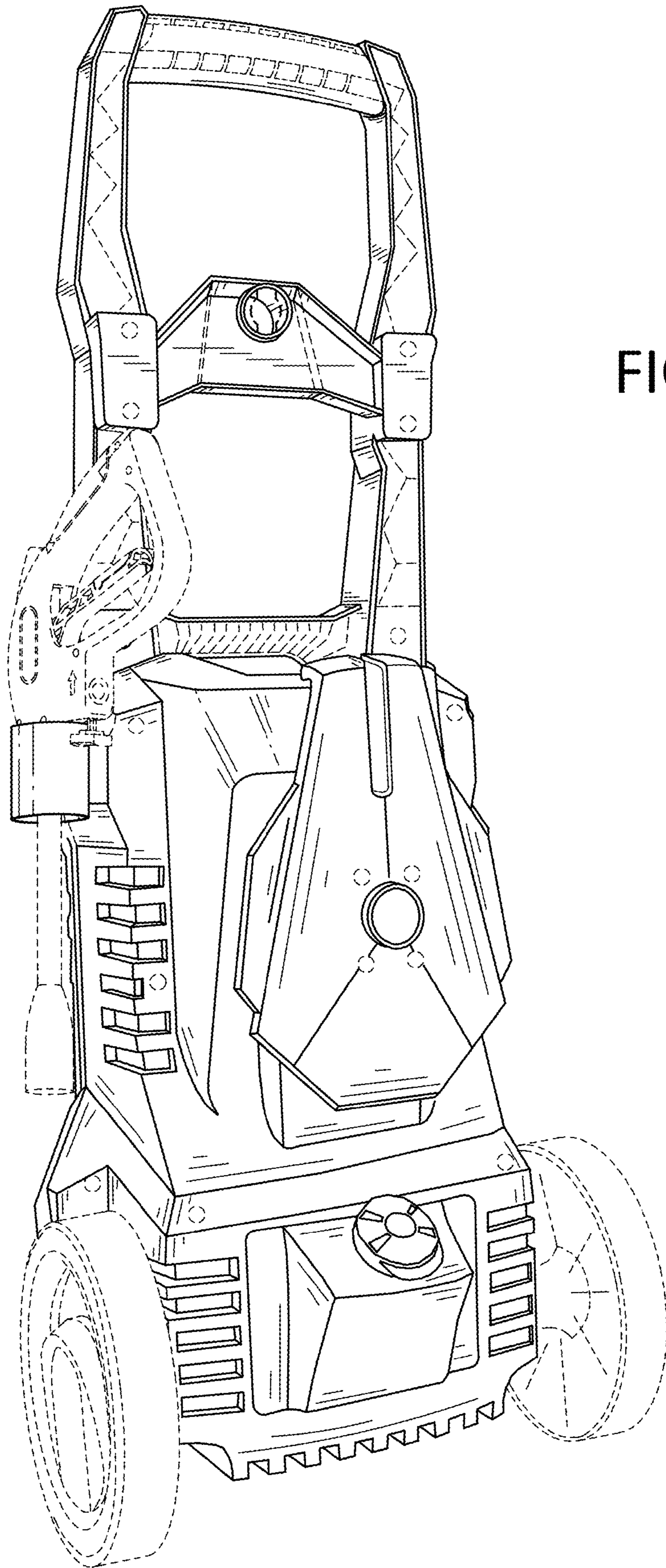

FIG. 2

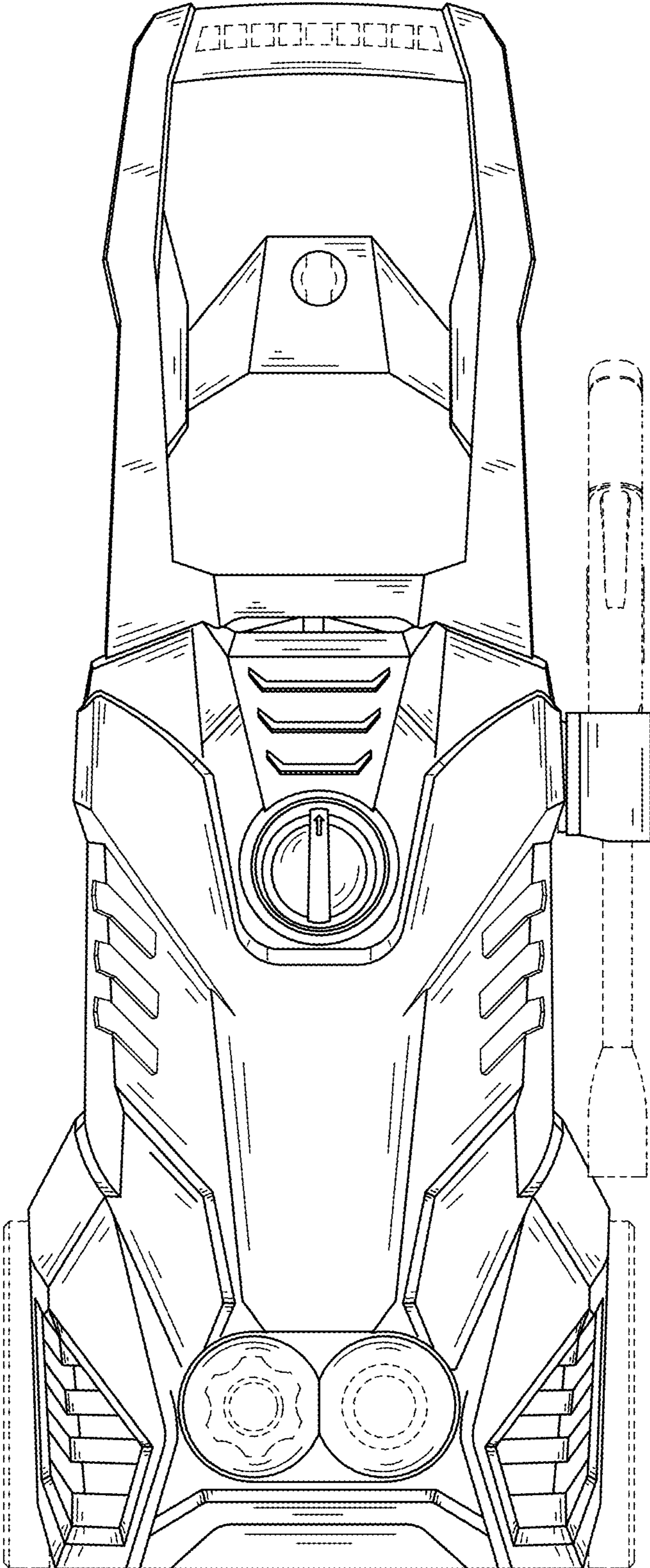

FIG. 3

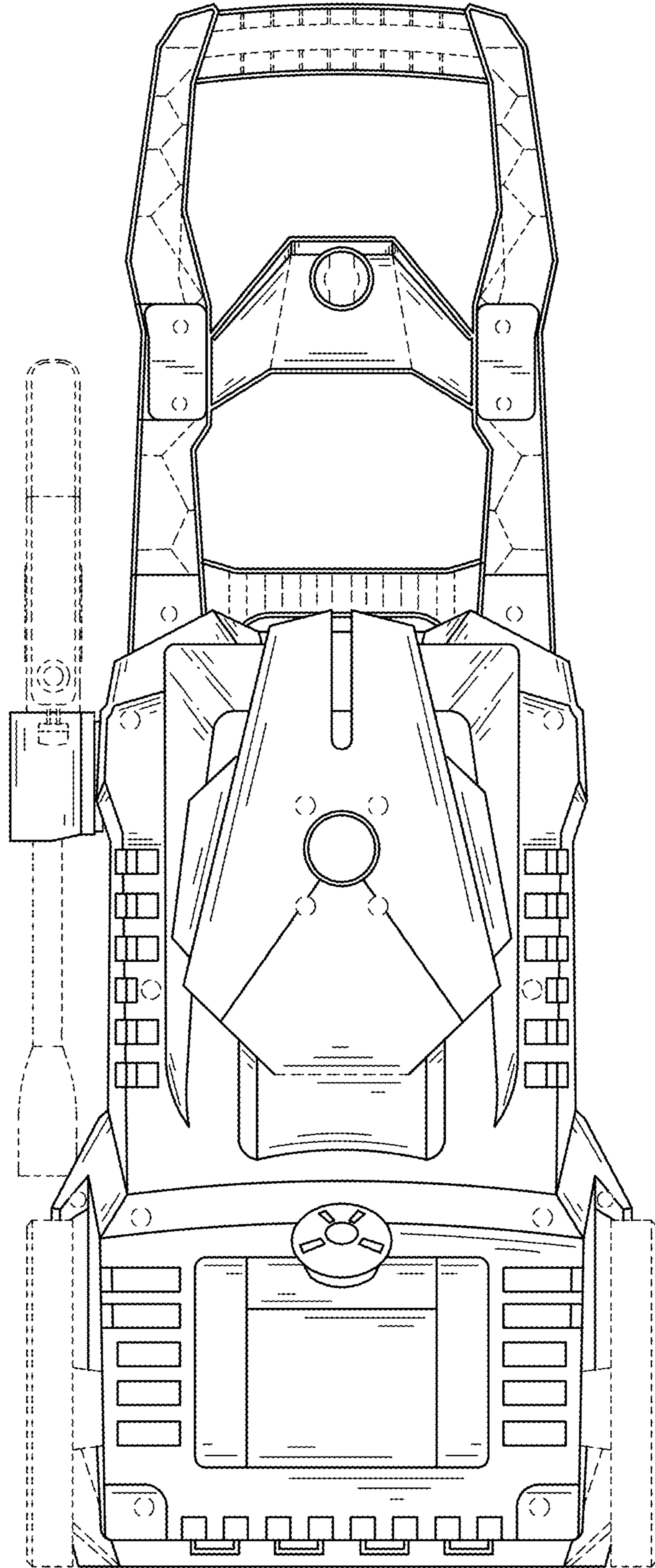

FIG. 4

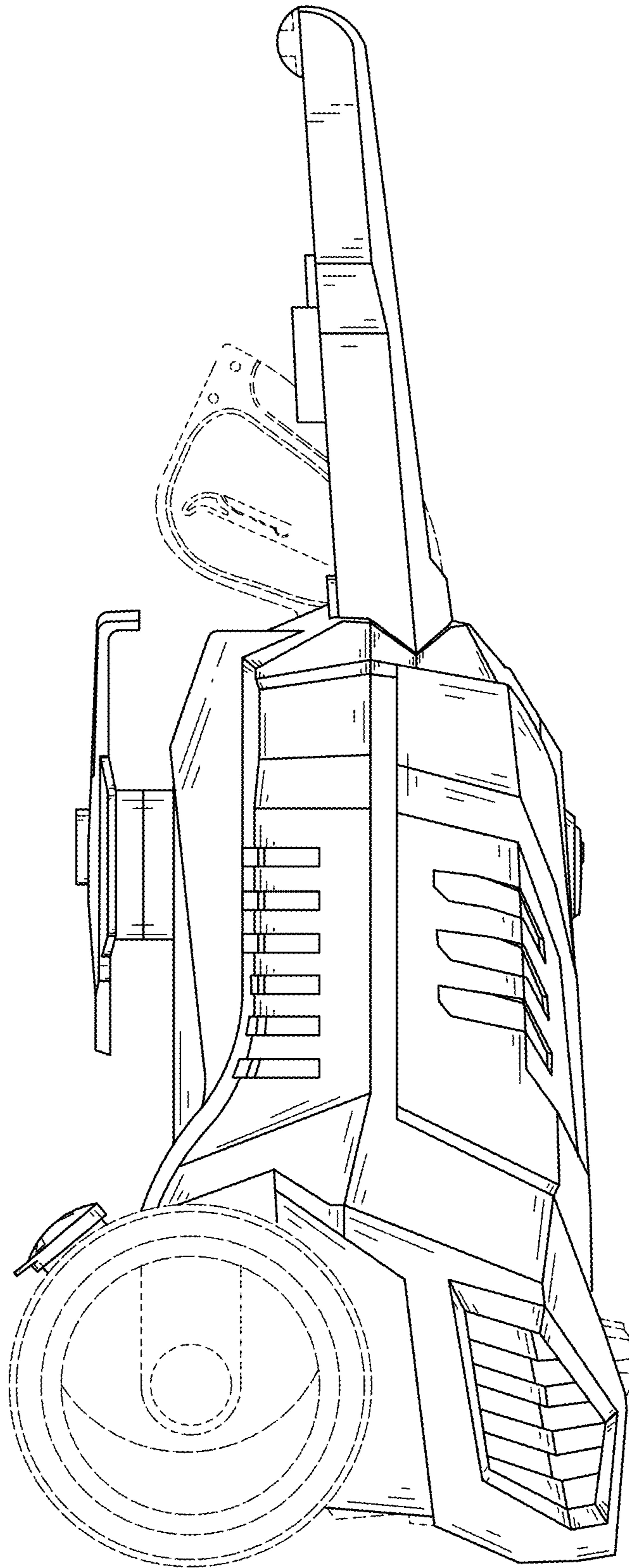

FIG. 5

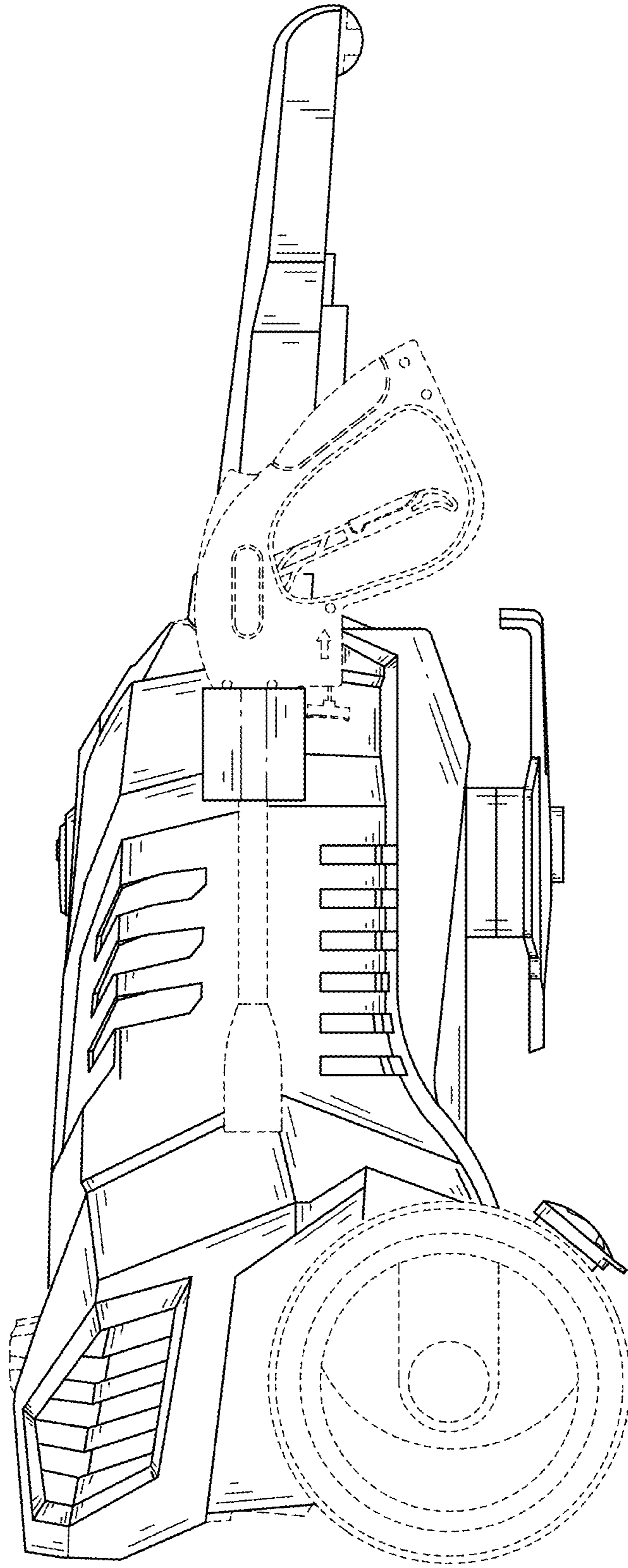

FIG. 6

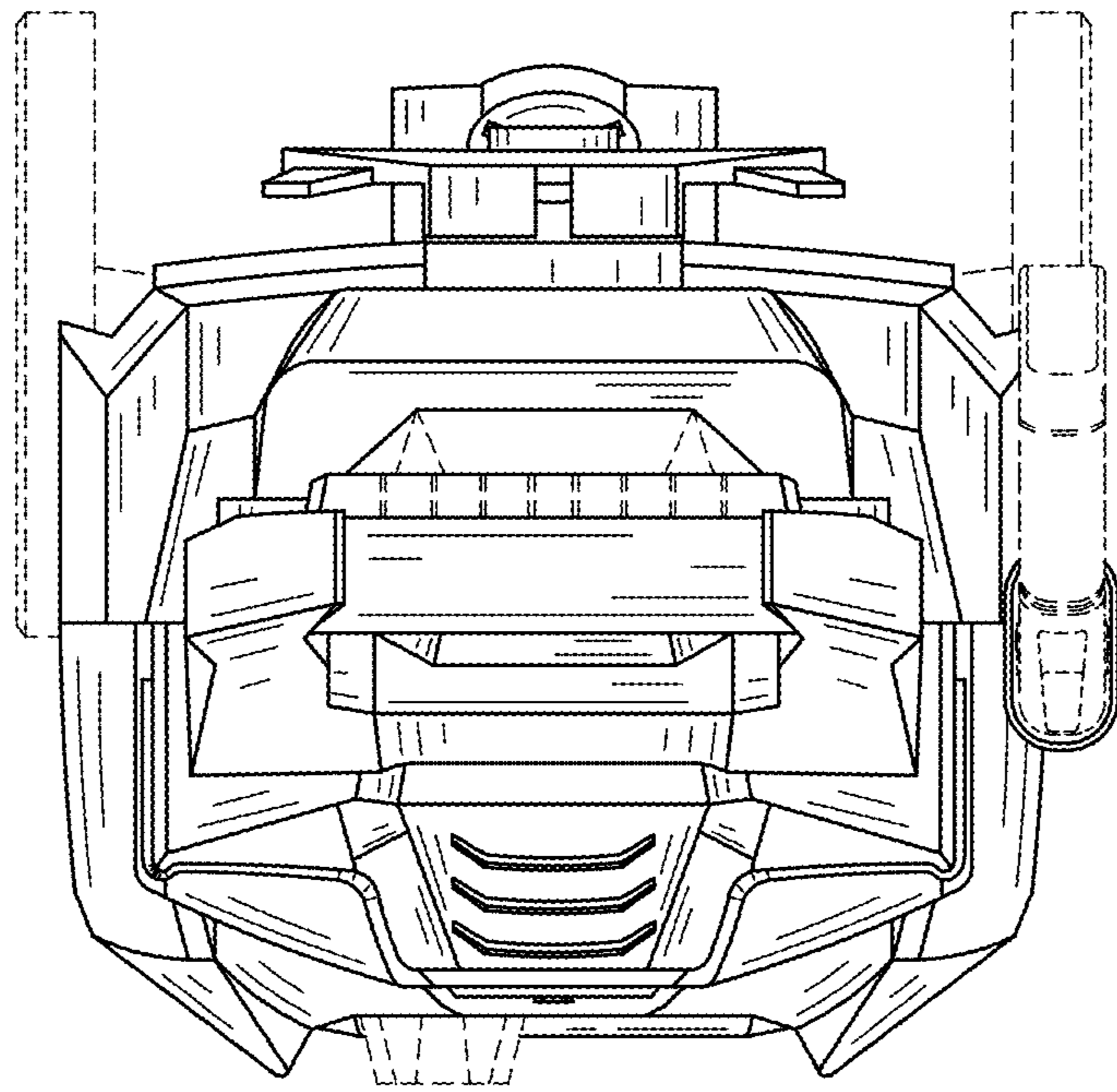

FIG. 7

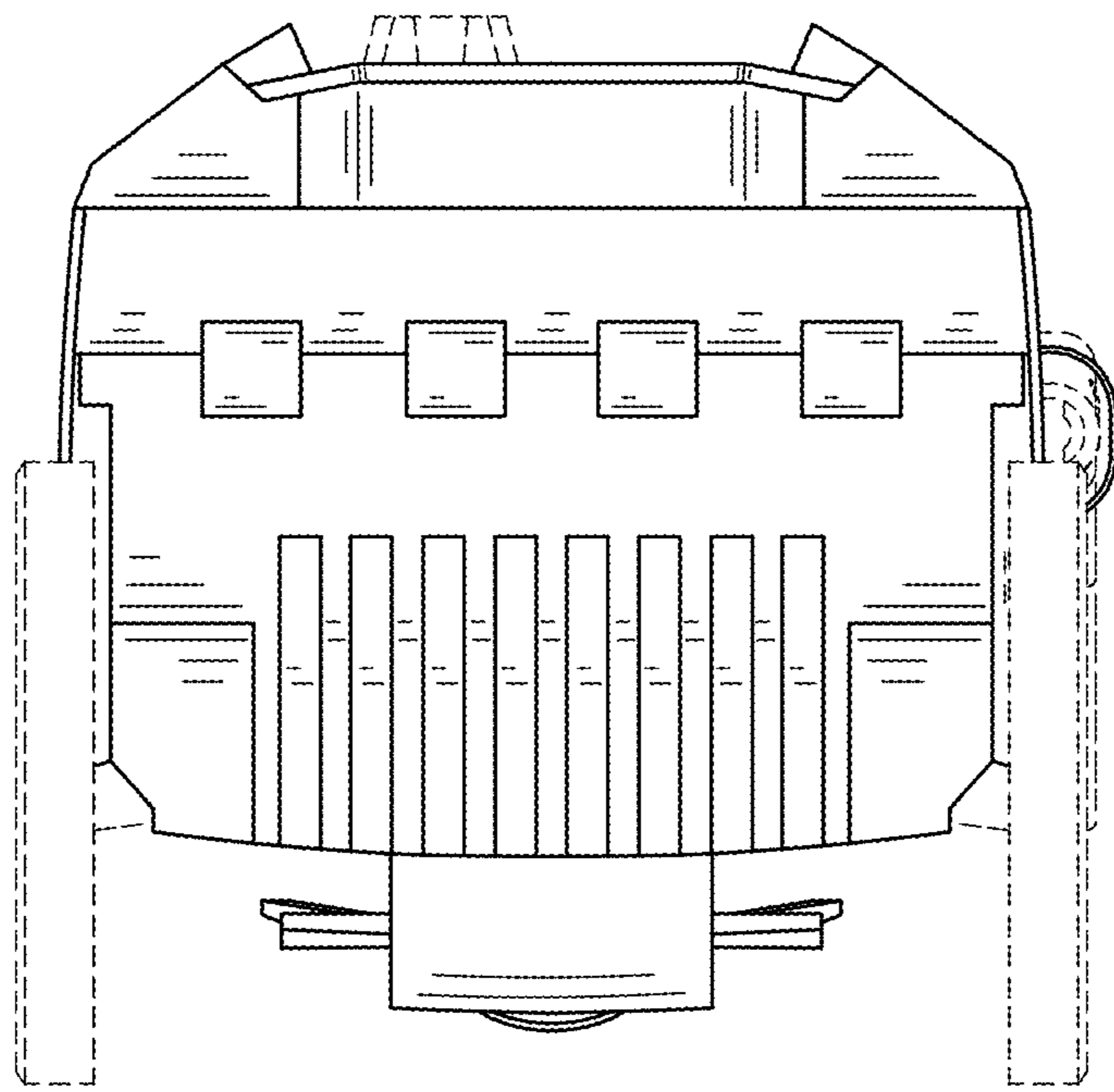

FIG. 8