



US00D932096S

(12) **United States Design Patent** (10) **Patent No.:** **US D932,096 S**
Liu (45) **Date of Patent:** **** Sep. 28, 2021**

(54) **ELECTRONIC CIGARETTE**

11/042; A61M 15/06; A61M 2205/82;
A61M 15/002; A61M 11/041;

(71) Applicant: **Tuanfang Liu**, Shenzhen (CN)

(Continued)

(72) Inventor: **Tuanfang Liu**, Shenzhen (CN)

(56) **References Cited**

(**) Term: **15 Years**

U.S. PATENT DOCUMENTS

(21) Appl. No.: **29/724,876**

D722,956 S * 2/2015 Alima D13/108
D731,112 S * 6/2015 Li D27/101

(22) Filed: **Feb. 20, 2020**

(Continued)

(30) **Foreign Application Priority Data**

FOREIGN PATENT DOCUMENTS

Oct. 10, 2019 (CN) 20193055088.2

CN 201630489939 * 2/2017
CN 202030123619.8 * 10/2020

(51) **LOC (13) Cl.** **27-02**

OTHER PUBLICATIONS

(52) **U.S. Cl.**

USPC **D27/162**

(58) **Field of Classification Search**

USPC D27/100, 101, 162, 163, 164, 165, 166,
D27/167, 168, 169, 170, 171, 172, 173,
D27/174, 175, 176, 177, 178, 179, 180,
D27/181, 182, 183, 184, 185, 186, 187,
D27/188, 189, 190, 191, 192, 193;
D28/91.1; D23/360, 362; D24/110,
D24/110.4, 110.5, 110.6, 113

SMOKVape Pen 22 Review. By EcigsUK. Dated Mar. 16, 2017.
Found online [Feb. 17, 2021]. <https://www.youtube.com/watch?v=Se4xt8DPYdg> (Year: 2017).*

(Continued)

CPC A24F 40/10; A24F 40/40; A24F 40/46;
A24F 40/42; A24F 40/44; A24F 40/485;
A24F 40/50; A24F 40/60; A24F 40/90;
A24F 40/53; A24F 40/70; A24F 40/48;
A24F 40/51; A24F 40/57; A24F 40/05;
A24F 40/65; A24F 40/20; A24F 47/002;
A24F 40/30; A24F 7/00; A24F 47/00;
A24F 1/32; A24F 40/00; A24F 40/49;
A24F 40/85; A24F 40/95; A24F 7/04;
A24F 9/16; A24F 47/008; A24F 15/015;
A24F 40/465; A24F 42/60; A24F 1/02;
A24F 2700/03; A24F 47/006; A24F
13/00; A24F 13/14; A24F 15/01; A24F
15/12; A24F 15/14; A24F 15/18; A24F
42/00; A24F 42/10; A24F 7/02; A24F
47/004; A24F 1/00; A24F 42/20; A61M

Primary Examiner — Marissa J Cash
Assistant Examiner — William B Melliar
(74) *Attorney, Agent, or Firm* — Matthias Scholl P.C.;
Matthias Scholl

(57) **CLAIM**

The ornamental design for an electronic cigarette, as shown
and described.

DESCRIPTION

FIG. 1 is a front elevation view of an electronic cigarette;
FIG. 2 is a rear elevation view thereof;
FIG. 3 is a left-side elevation view thereof;
FIG. 4 is a right-side elevation view thereof;
FIG. 5 is a top plan view thereof;
FIG. 6 is a bottom plan view thereof; and,
FIG. 7 is a perspective view thereof.

(Continued)

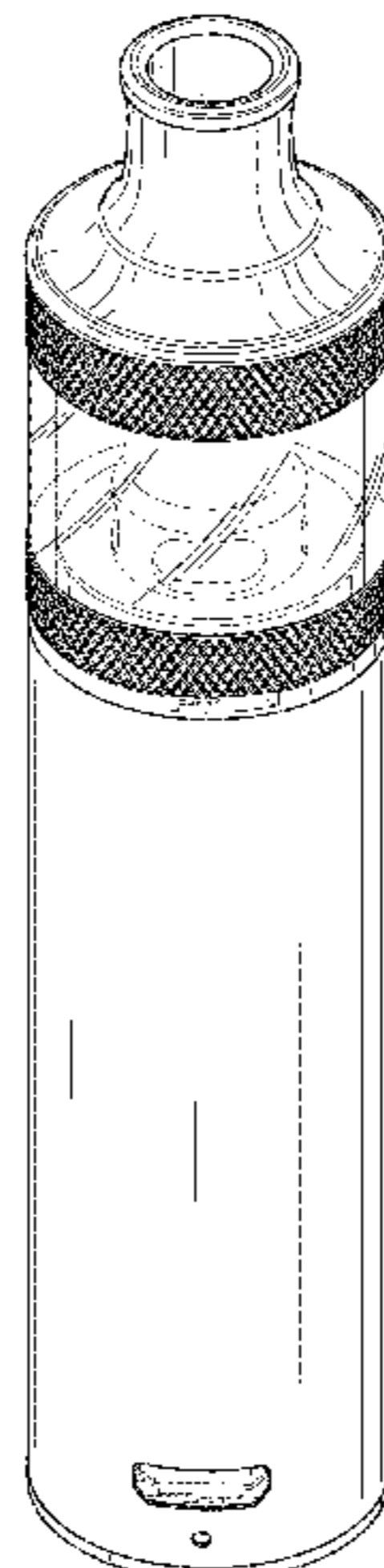

The broken lines in the drawings depict portions of the electronic cigarette that form no part of the claimed design.

1 Claim, 7 Drawing Sheets

(58) **Field of Classification Search**

CPC A61M 15/0001; A61M 15/0085; A61M 11/001; A61M 11/04; A61M 11/044; A61M 15/0015; A61M 15/0021; A61M 15/0028; A61M 15/0091; A61M 15/0095; A61M 16/0808; A61M 2205/0211; A61M 2205/0238; A61M 2205/0272; A61M 2205/123; A61M 2205/3334; A61M 2205/58; A61M 2205/7536; A61M 2205/3653; A61M 2205/18; A61M 2205/3317; A61M 2205/50; A61M 2205/52; A61M 2205/3368; A24B 15/167

See application file for complete search history.

(56) **References Cited**

U.S. PATENT DOCUMENTS

D751,249 S * 3/2016 Chen D27/101
 D753,873 S * 4/2016 Schuessler D27/101

D756,030 S * 5/2016 Chen D27/101
 D778,492 S * 2/2017 Liu D27/101
 D783,117 S * 4/2017 Gilbarte D22/117
 D805,248 S * 12/2017 Chen D27/170
 D806,942 S * 1/2018 Qiu D27/101
 D806,943 S * 1/2018 Liu D27/101
 D870,962 S * 12/2019 Choe D27/163
 D882,165 S * 4/2020 Ouyang D27/162
 D899,677 S * 10/2020 Liu D27/162
 D900,387 S * 10/2020 Liu D27/162
 D901,068 S * 11/2020 Stone D27/101
 D907,287 S * 1/2021 Wang D27/162
 2016/0183596 A1 * 6/2016 Rado A24F 47/008
 392/395

OTHER PUBLICATIONS

The Eleaf iJust S Kit. By RiP Trippers. Dated Aug. 1, 2016. Found online [Feb. 17, 2021]. <https://www.youtube.com/watch?v=j8JDqy0BFFs> (Year: 2016).*

Classic Skyscraper Dry herb Vape Pen Black Clip Web. By MG Magazine. Dated Feb. 11, 2021, Found online [Feb. 22, 2021]. https://mgretailer.com/business/retail-merchandise/vape-products-ultimate-buyers-guide/attachment/classic-skyscraper-dry-herb-vape-pen_black_clip_web/ (Year: 2021).*

* cited by examiner

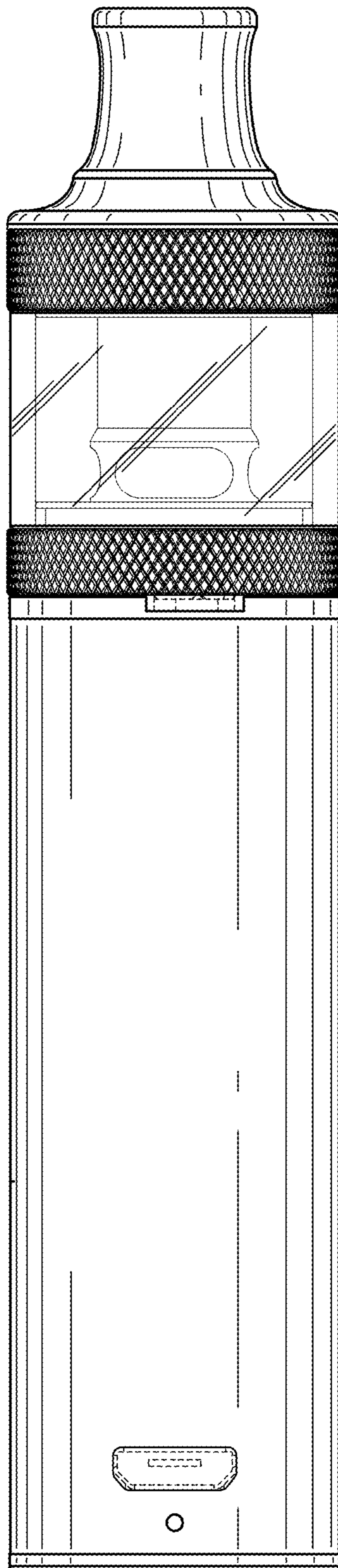

FIG. 1

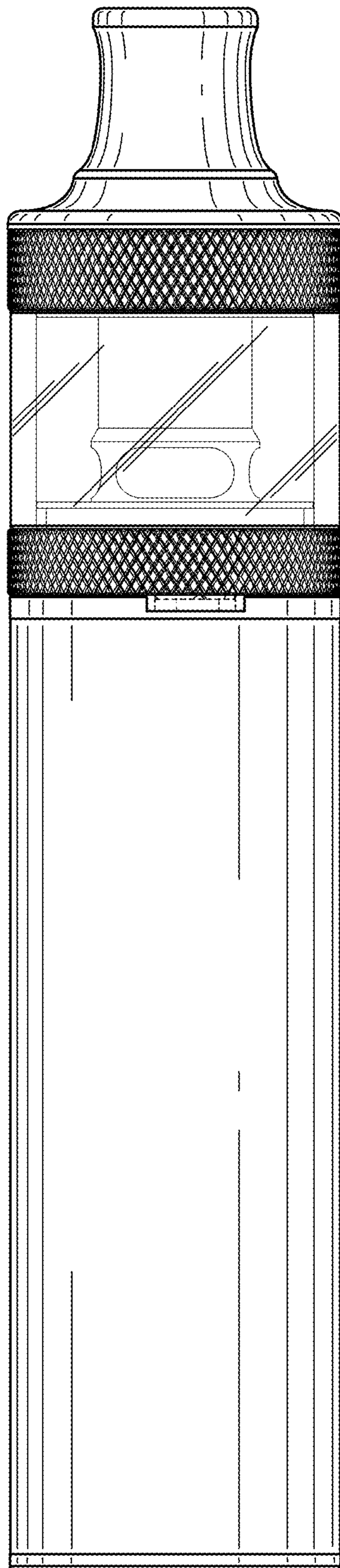

FIG. 2

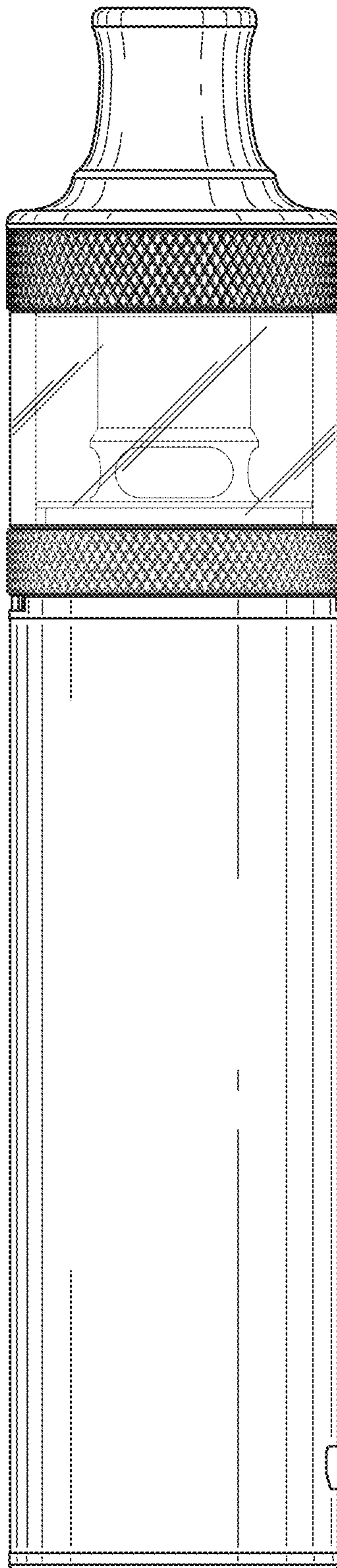

FIG. 3

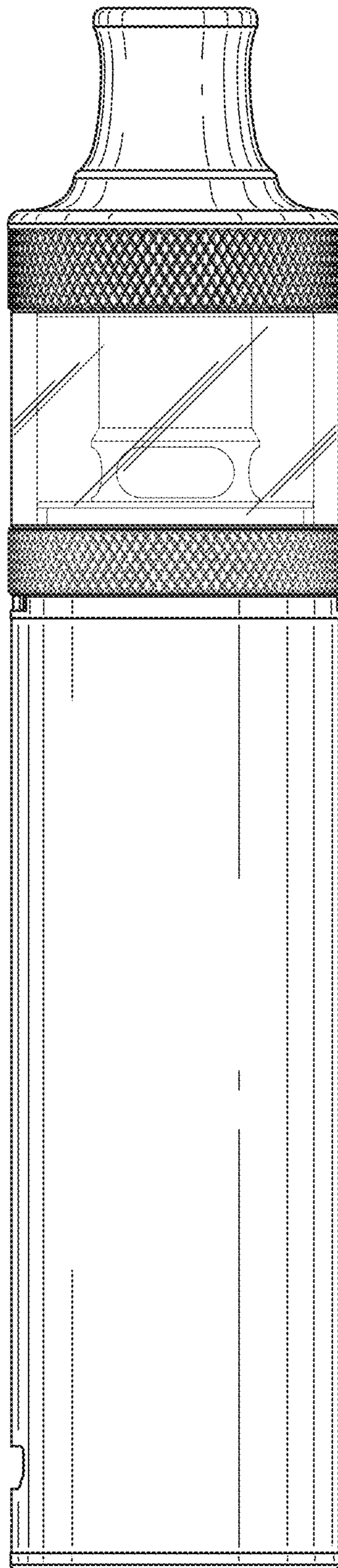

FIG. 4

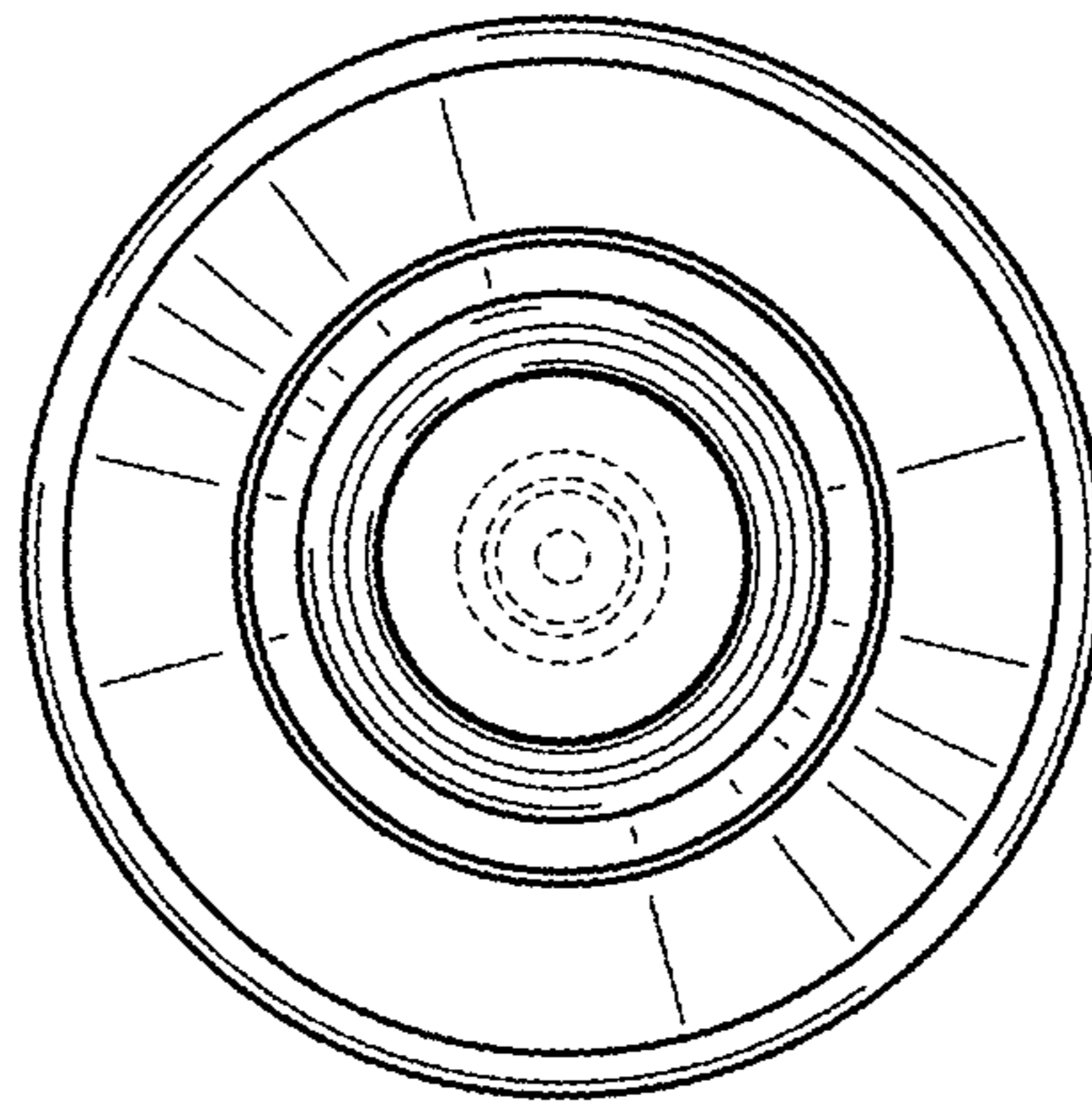

FIG. 5

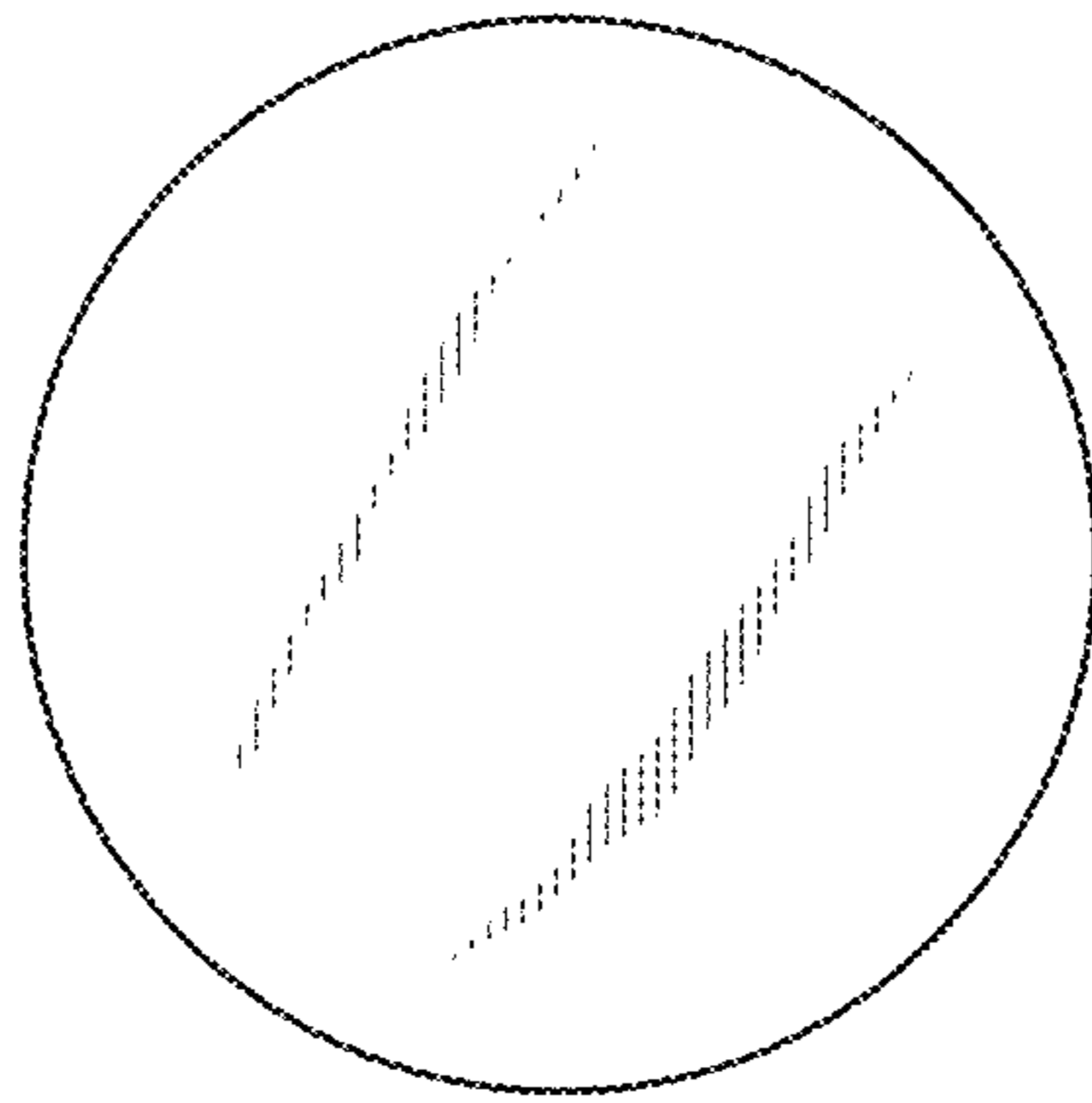

FIG. 6

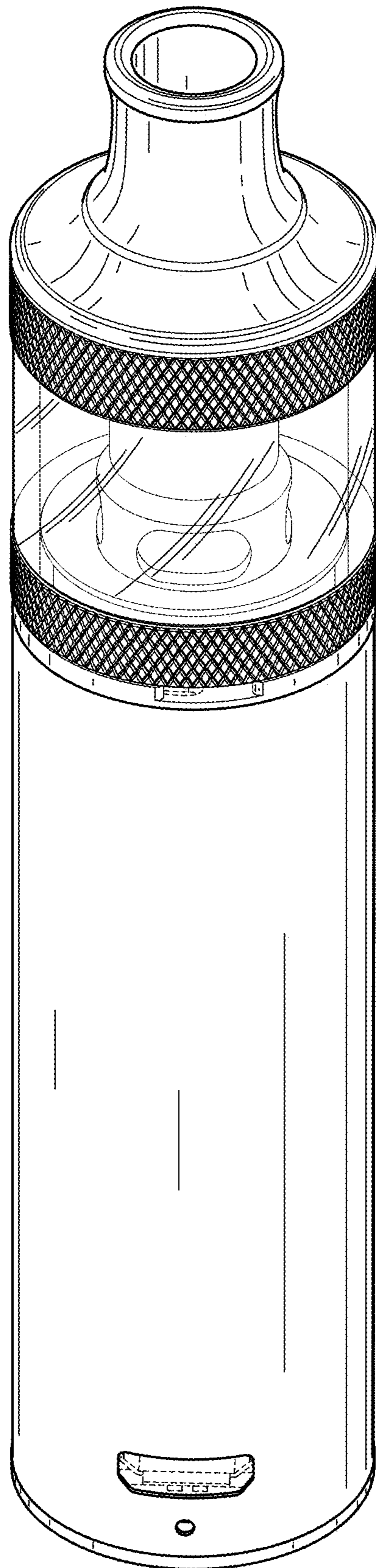

FIG. 7