



US00D931998S

(12) **United States Design Patent**  
**Chu**

(10) **Patent No.:** **US D931,998 S**

(45) **Date of Patent:** **\*\* Sep. 28, 2021**

(54) **TOWER FAN**

(71) Applicant: **Guangdong Lesheng Intelligent Technology Co., Ltd., Dongguan (CN)**

(72) Inventor: **Yunjiang Chu, Hunan (CN)**

(\*\*) Term: **15 Years**

(21) Appl. No.: **29/717,321**

(22) Filed: **Dec. 17, 2019**

(51) **LOC (13) Cl.** ..... **23-04**

(52) **U.S. Cl.**  
USPC ..... **D23/378**

(58) **Field of Classification Search**  
USPC ..... D23/314, 351, 353, 354, 364, 366,  
D23/370-376, 378, 381, 383, 385, 388,  
D23/393, 395, 411, 412, 332, 333, 335,  
D23/337  
CPC ..... F04D 25/088; F04D 29/388; F04D 29/34;  
F04D 25/08; F21V 33/0096  
See application file for complete search history.

D715,913 S \* 10/2014 Schouten ..... A61L 9/12  
D23/366  
D837,354 S \* 1/2019 Su ..... D23/364  
D882,055 S \* 4/2020 Ediger ..... D23/356  
D892,294 S \* 8/2020 Cartwright ..... D23/370  
2020/0378635 A1\* 12/2020 Ediger ..... F24F 13/32

\* cited by examiner

*Primary Examiner* — Lilyana Bekic

*Assistant Examiner* — Sharon S Oum

(74) *Attorney, Agent, or Firm* — Prakash Nama; Global IP Services, PLLC

(57) **CLAIM**

The ornamental design for a tower fan, as shown and described.

**DESCRIPTION**

FIG. 1 is a front elevational view of a tower fan showing my new design;  
 FIG. 2 is a rear elevational view thereof;  
 FIG. 3 is a left side view thereof;  
 FIG. 4 is a right side view thereof;  
 FIG. 5 is a top plan view thereof;  
 FIG. 6 is a bottom plan view thereof;  
 FIG. 7 is a perspective view thereof;  
 FIG. 8 is a second perspective view thereof; and,  
 FIG. 9 is a third perspective view thereof.  
 The broken lines shown in tower fan form no part of the claimed design.

(56) **References Cited**

**U.S. PATENT DOCUMENTS**

D290,997 S \* 7/1987 Utsuki ..... D23/342  
 D291,594 S \* 8/1987 Norman ..... D23/366  
 D423,093 S \* 4/2000 Fok ..... D23/370  
 D515,193 S \* 2/2006 Chen ..... D23/366  
 D672,858 S \* 12/2012 Abbondanzio ..... D23/366

**1 Claim, 8 Drawing Sheets**

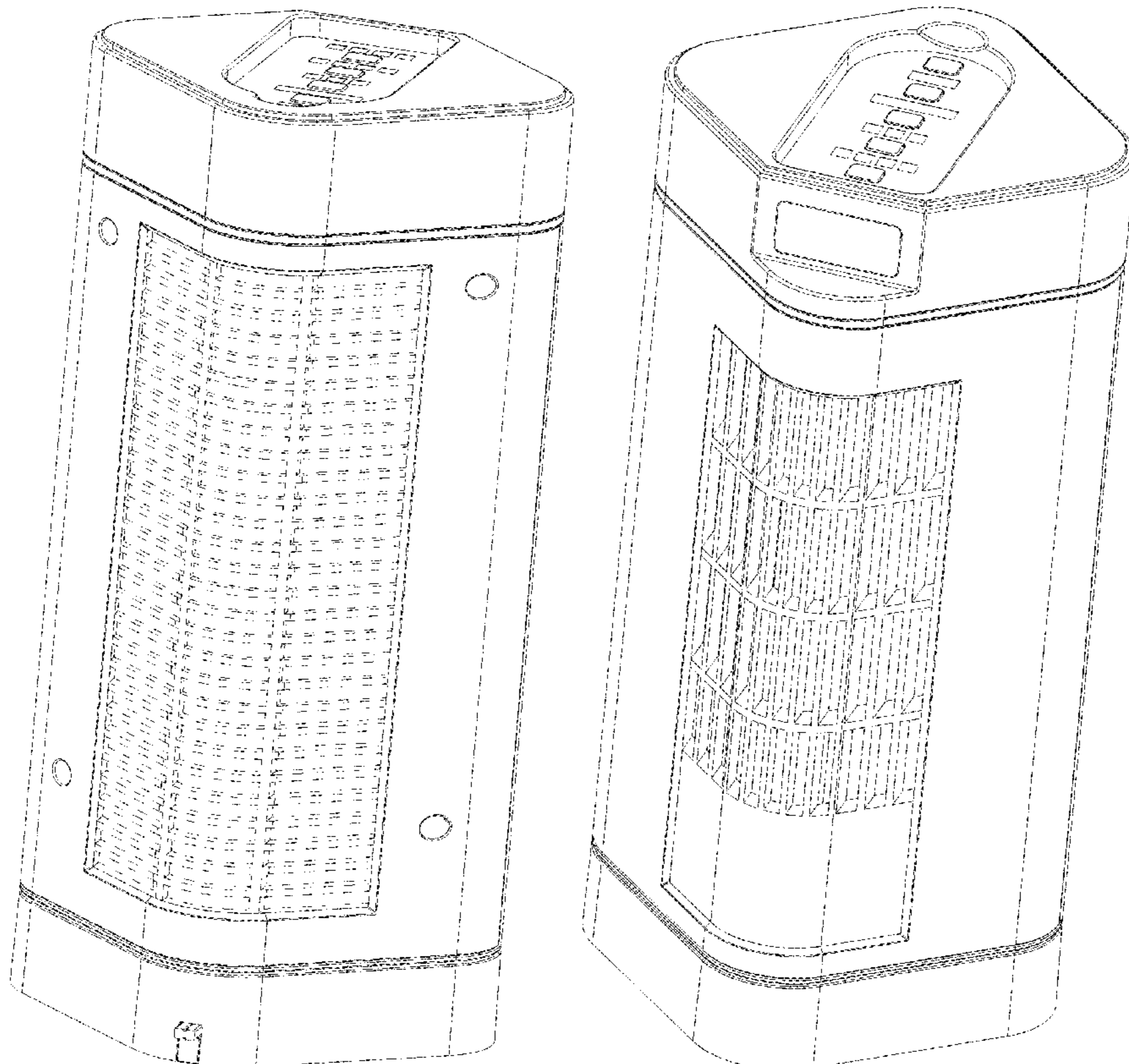

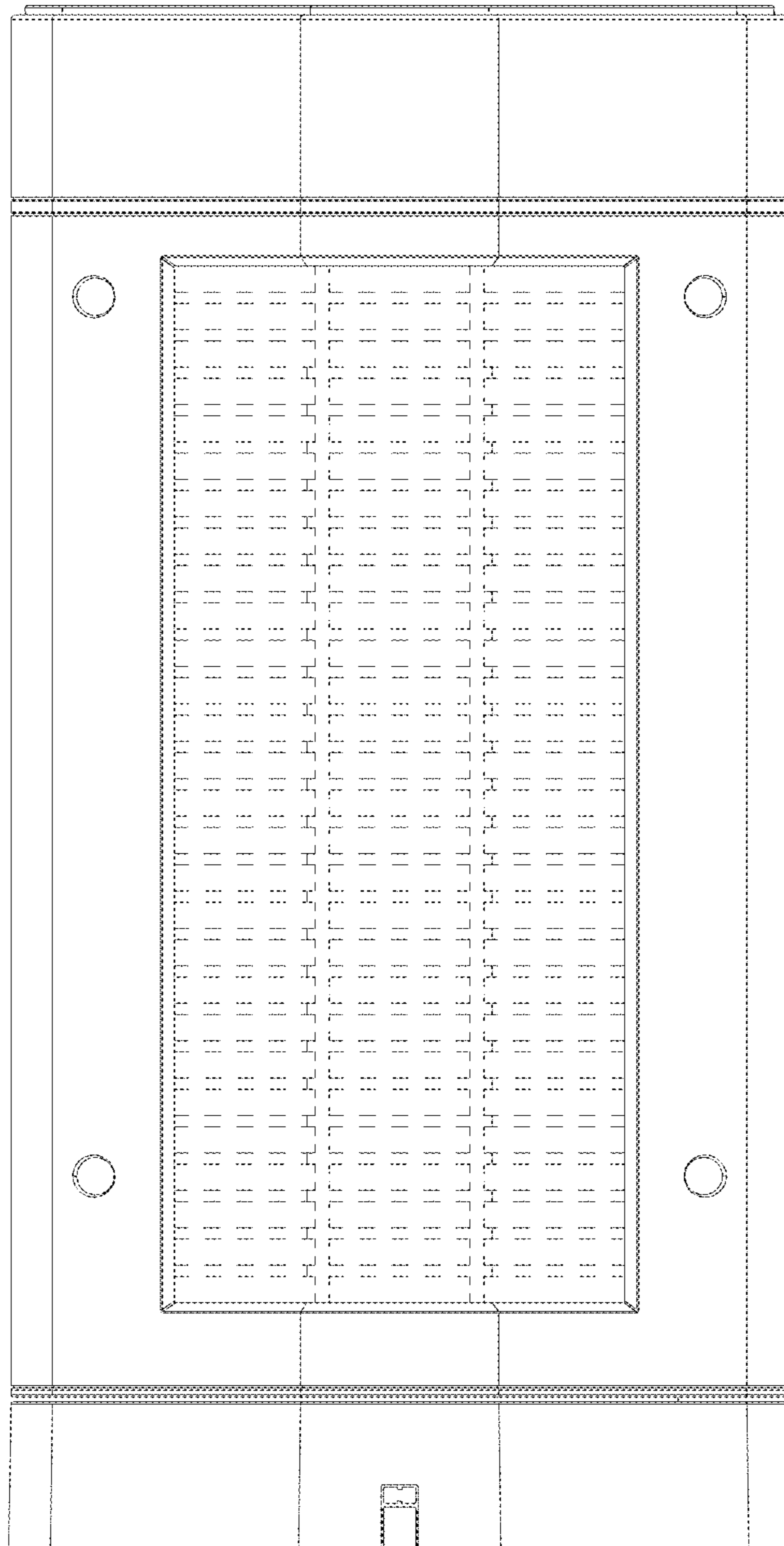

FIG. 1

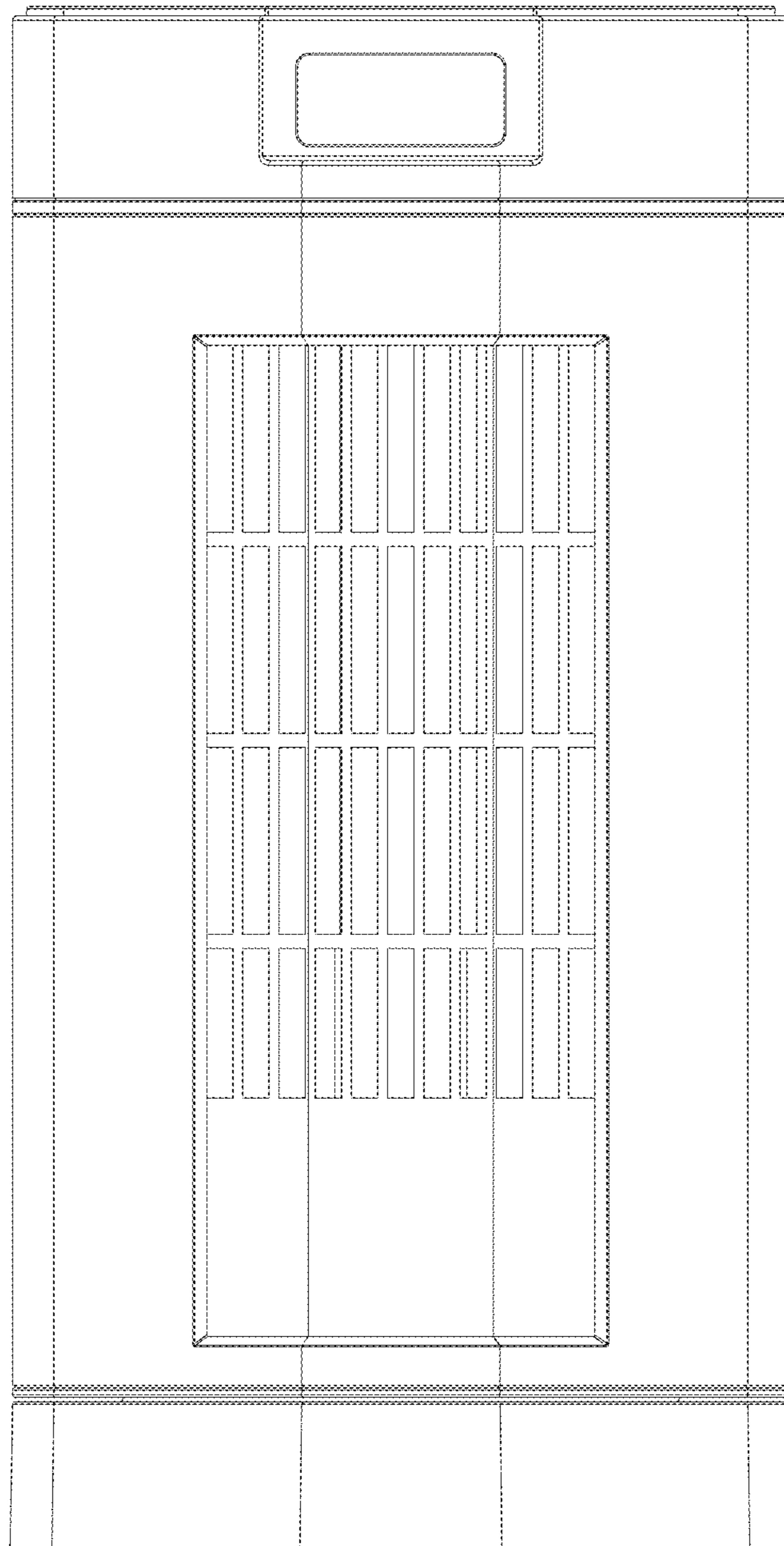

FIG. 2

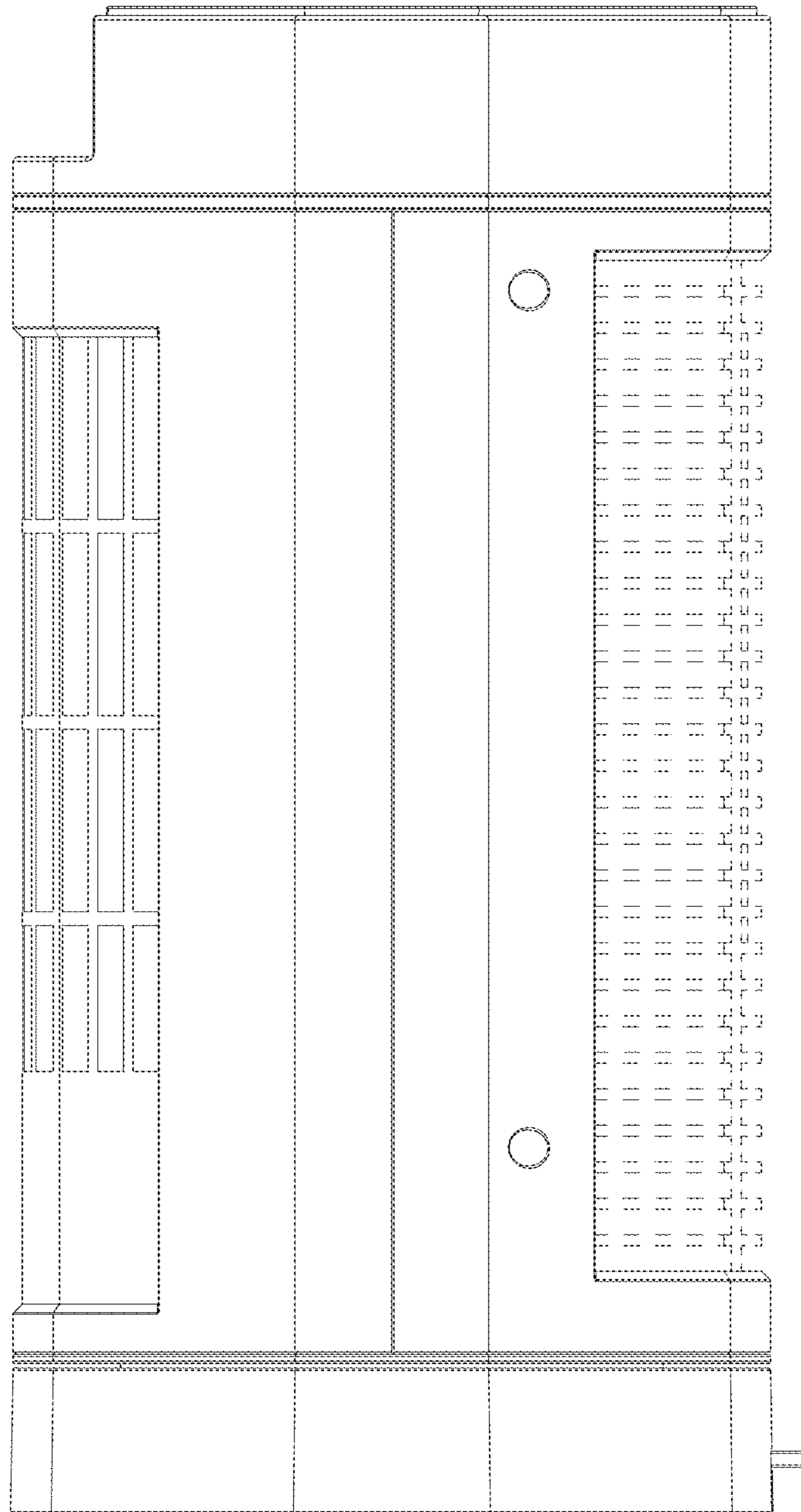

FIG. 3

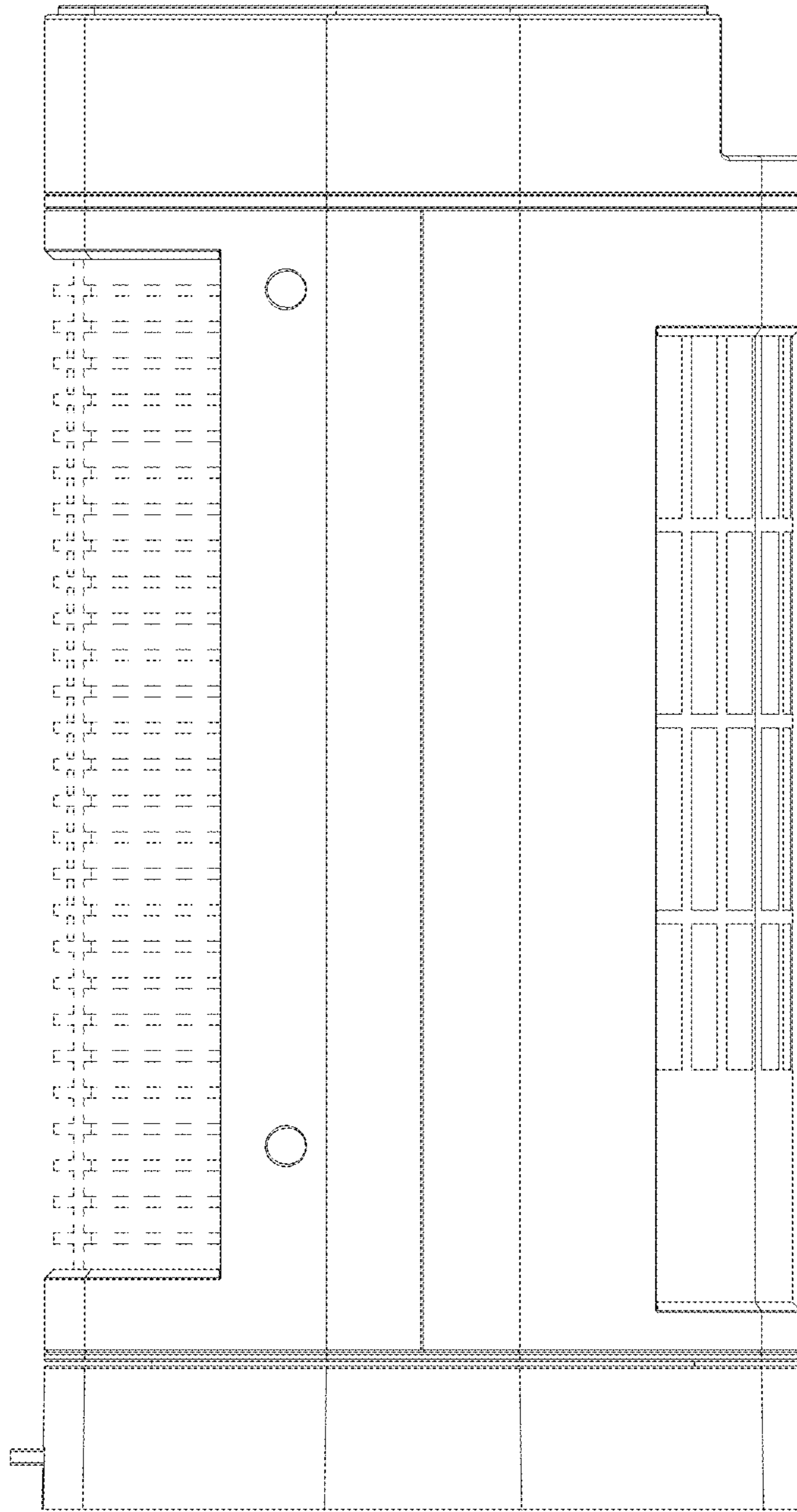

FIG. 4

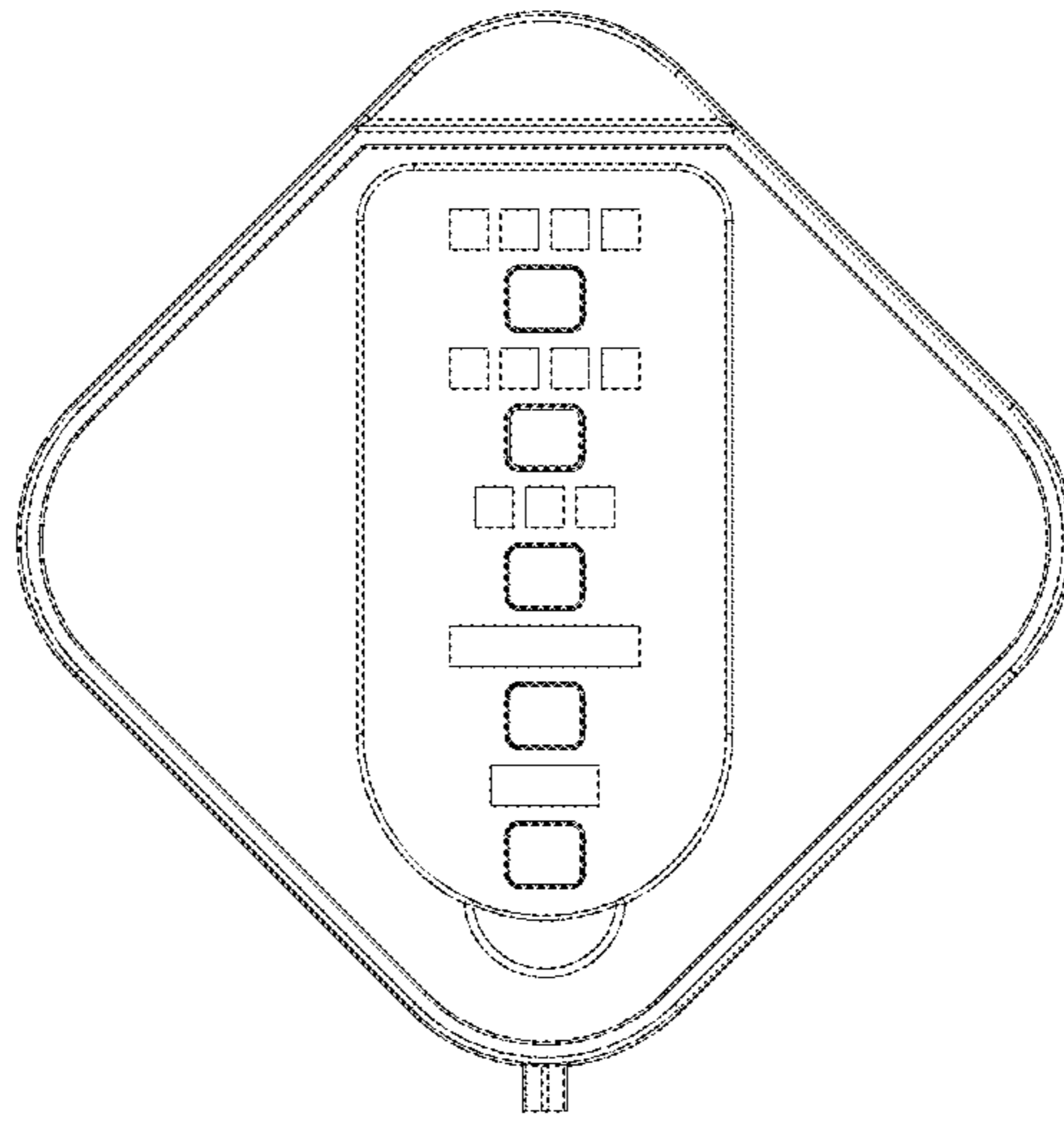

FIG. 5

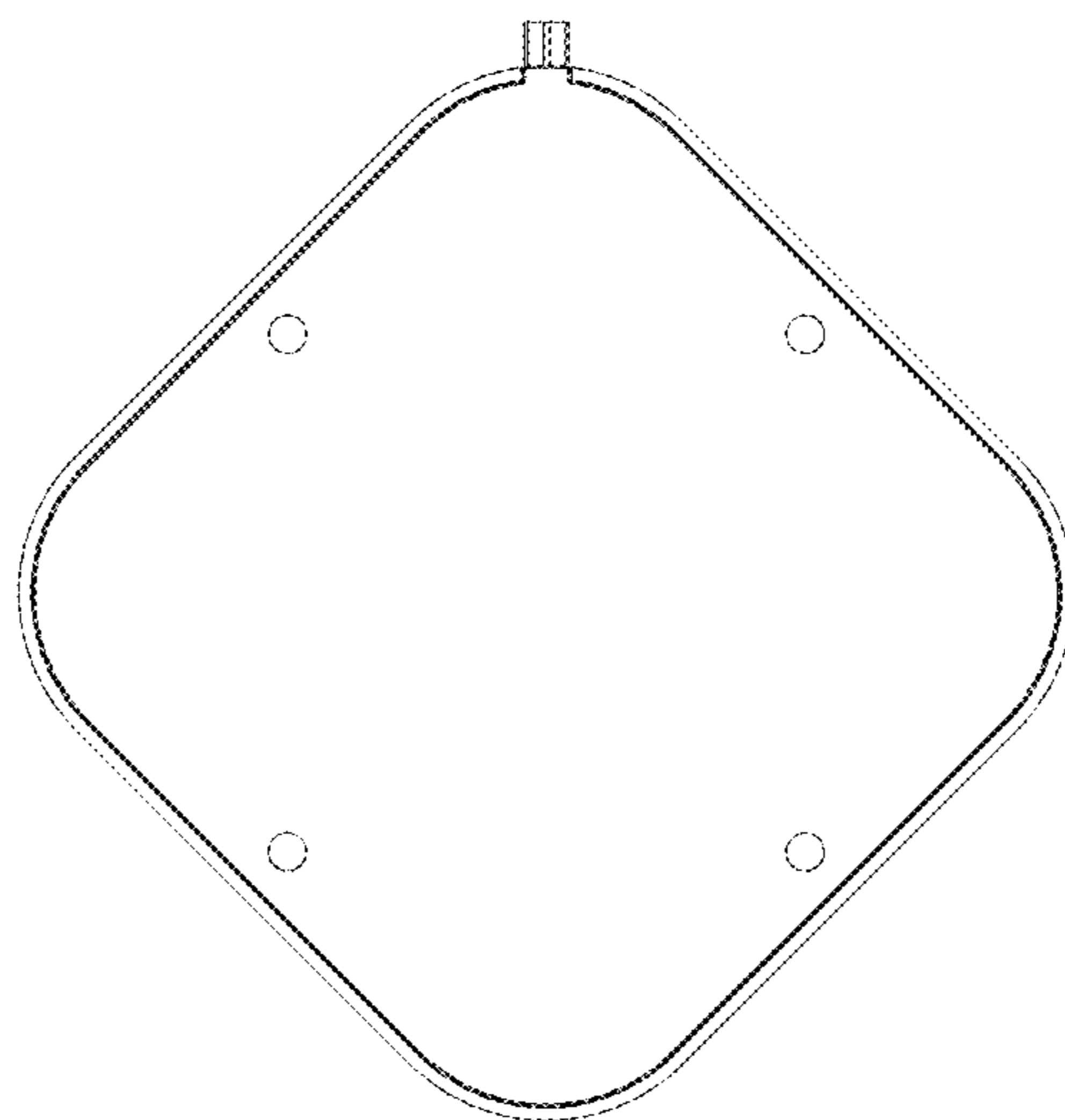

FIG. 6

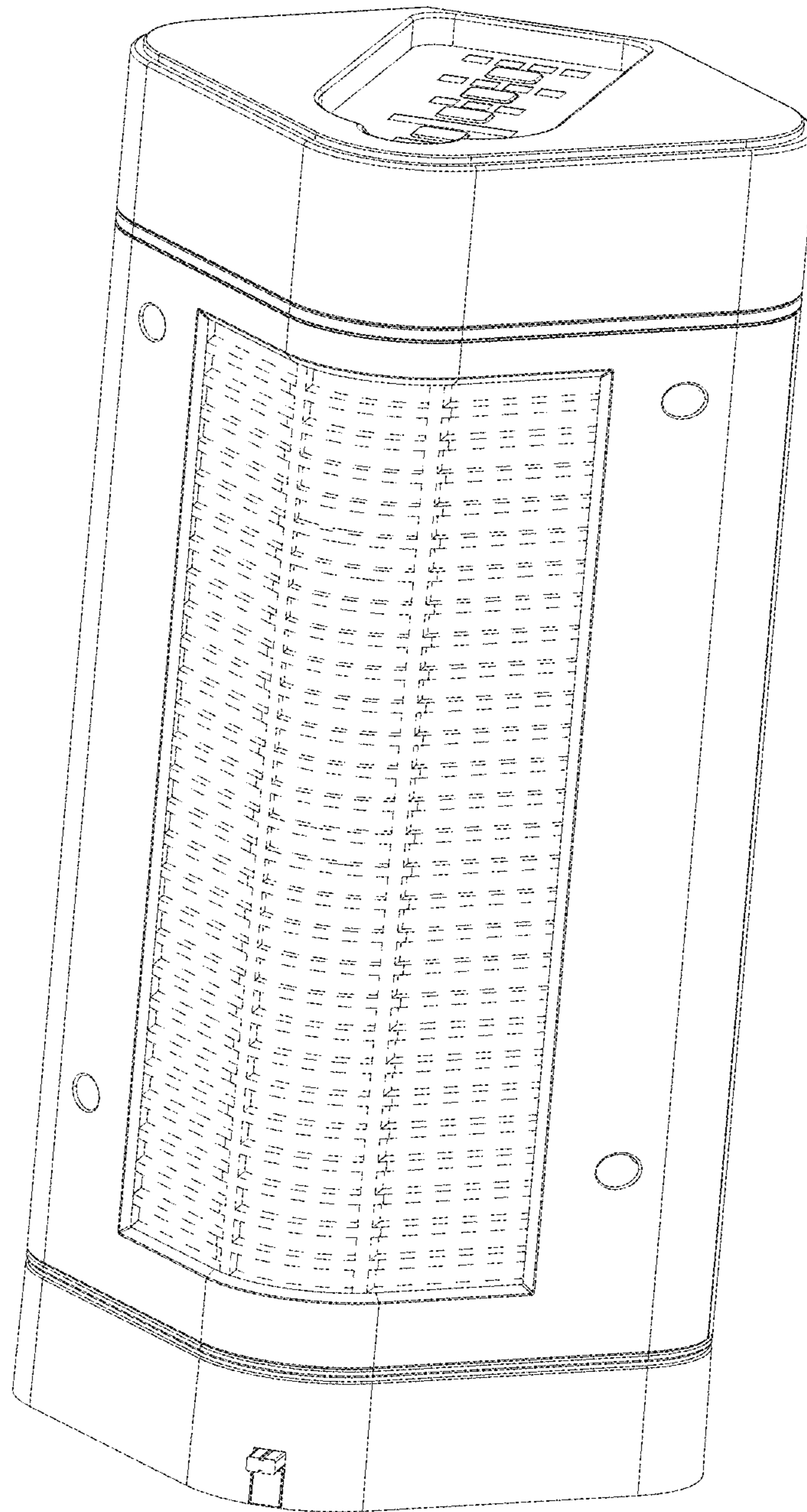

FIG. 7

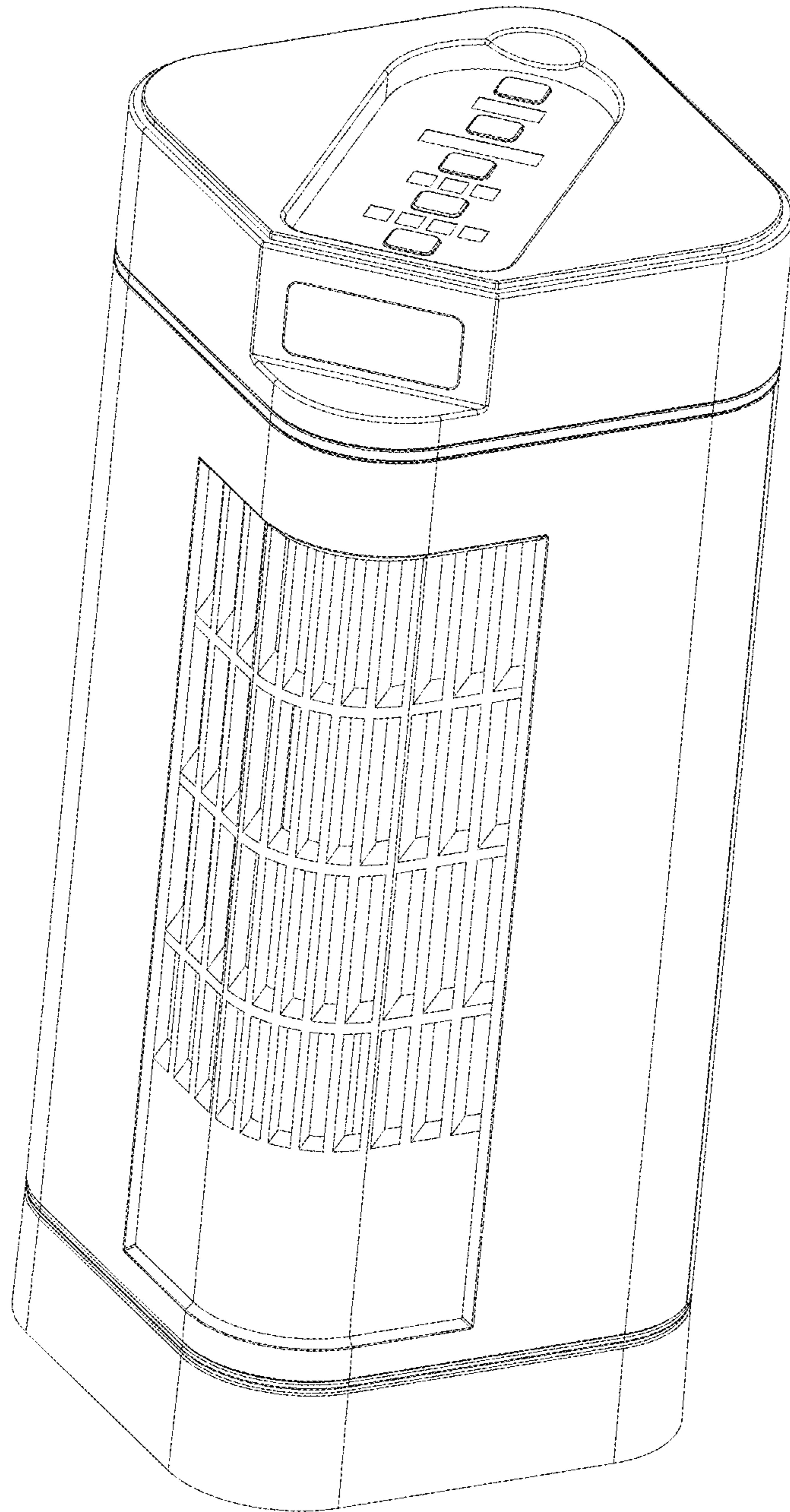

FIG. 8



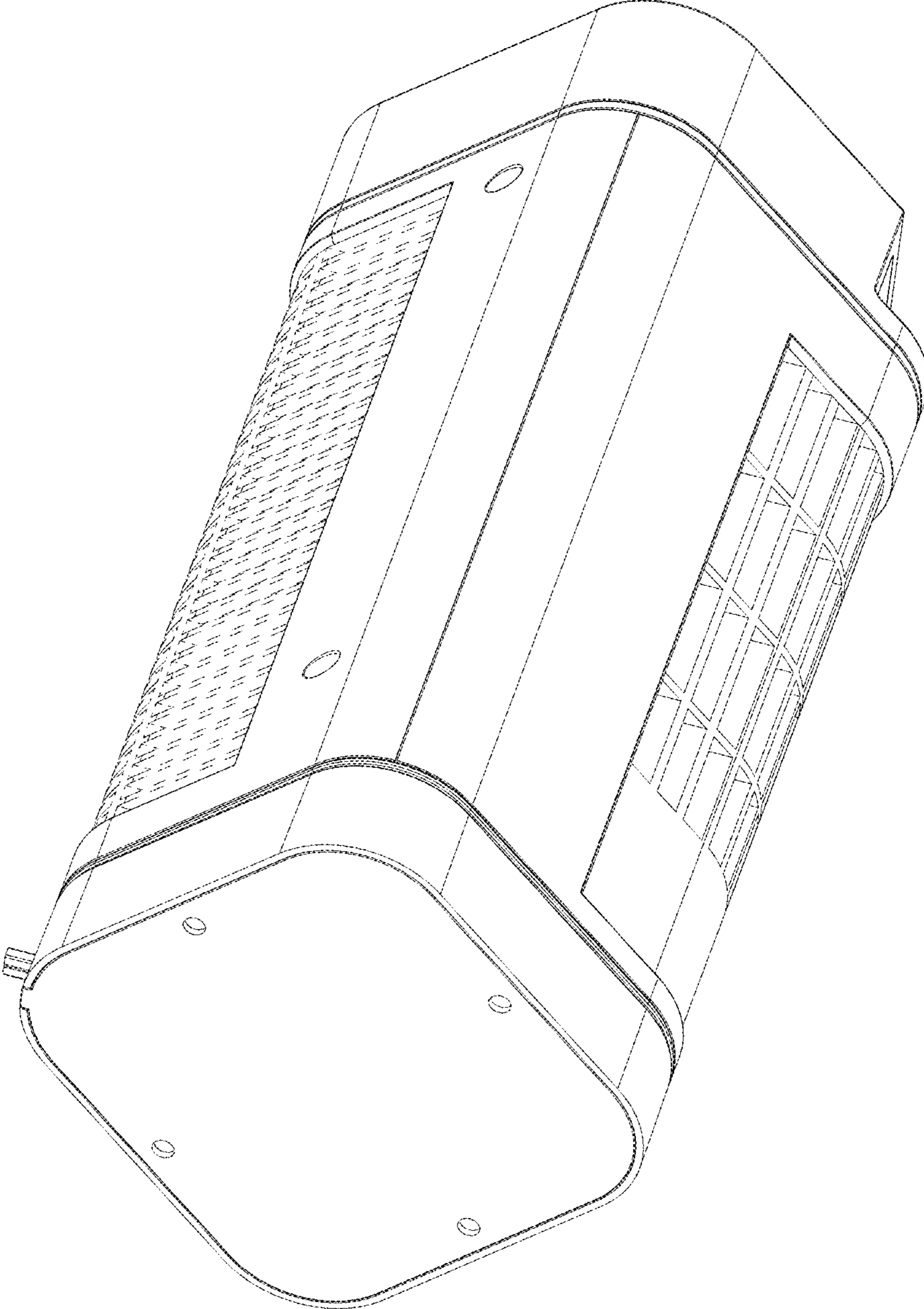

FIG. 9